



CODE OF FEDERAL REGULATIONS

Title 24

Housing and Urban Development

Part 1700 to End

Revised as of April 1, 2011

Containing a codification of documents
of general applicability and future effect

As of April 1, 2011

Published by the Office of the Federal Register
National Archives and Records Administration
as a Special Edition of the Federal Register



U.S. GOVERNMENT OFFICIAL EDITION NOTICE

Legal Status and Use of Seals and Logos

The seal of the National Archives and Records Administration (NARA) authenticates the Code of Federal Regulations (CFR) as the official codification of Federal regulations established under the Federal Register Act. Under the provisions of 44 U.S.C. 1507, the contents of the CFR, a special edition of the Federal Register, shall be judicially noticed. The CFR is prima facie evidence of the original documents published in the Federal Register (44 U.S.C. 1510).

It is prohibited to use NARA's official seal and the stylized Code of Federal Regulations logo on any republication of this material without the express, written permission of the Archivist of the United States or the Archivist's designee. Any person using NARA's official seals and logos in a manner inconsistent with the provisions of 36 CFR part 1200 is subject to the penalties specified in 18 U.S.C. 506, 701, and 1017.

Use of ISBN Prefix

This is the Official U.S. Government edition of this publication and is herein identified to certify its authenticity. Use of the 0-16 ISBN prefix is for U.S. Government Printing Office Official Editions only. The Superintendent of Documents of the U.S. Government Printing Office requests that any reprinted edition clearly be labeled as a copy of the authentic work with a new ISBN.



U.S. GOVERNMENT PRINTING OFFICE

U.S. Superintendent of Documents • Washington, DC 20402-0001

<http://bookstore.gpo.gov>

Phone: toll-free (866) 512-1800; DC area (202) 512-1800

Table of Contents

	<i>Page</i>
Explanation	v
Title 24:	
SUBTITLE B—REGULATIONS RELATING TO HOUSING AND URBAN DEVELOPMENT (CONTINUED)	
Chapter X—Office of Assistant Secretary for Housing—Federal Housing Commissioner, Department of Housing and Urban Development (Interstate Land Sales Registration Program)	5
Chapter XII—Office of Inspector General, Department of Housing and Urban Development	87
Chapter XV—Emergency Mortgage Insurance and Loan Programs, Department of Housing and Urban Development	105
Chapter XX—Office of Assistant Secretary for Housing—Federal Housing Commissioner, Department of Housing and Urban Development	119
Chapter XXIV—Board of Directors of the Hope for Homeowners Program	409
Chapter XXV—Neighborhood Reinvestment Corporation	423
Finding Aids:	
Table of CFR Titles and Chapters	435
Alphabetical List of Agencies Appearing in the CFR	455
List of CFR Sections Affected	465

Cite this Code: CFR

*To cite the regulations in
this volume use title,
part and section num-
ber. Thus, 24 CFR
1710.1 refers to title 24,
part 1710, section 1.*

Explanation

The Code of Federal Regulations is a codification of the general and permanent rules published in the Federal Register by the Executive departments and agencies of the Federal Government. The Code is divided into 50 titles which represent broad areas subject to Federal regulation. Each title is divided into chapters which usually bear the name of the issuing agency. Each chapter is further subdivided into parts covering specific regulatory areas.

Each volume of the Code is revised at least once each calendar year and issued on a quarterly basis approximately as follows:

Title 1 through Title 16.....	as of January 1
Title 17 through Title 27.....	as of April 1
Title 28 through Title 41.....	as of July 1
Title 42 through Title 50.....	as of October 1

The appropriate revision date is printed on the cover of each volume.

LEGAL STATUS

The contents of the Federal Register are required to be judicially noticed (44 U.S.C. 1507). The Code of Federal Regulations is prima facie evidence of the text of the original documents (44 U.S.C. 1510).

HOW TO USE THE CODE OF FEDERAL REGULATIONS

The Code of Federal Regulations is kept up to date by the individual issues of the Federal Register. These two publications must be used together to determine the latest version of any given rule.

To determine whether a Code volume has been amended since its revision date (in this case, April 1, 2011), consult the "List of CFR Sections Affected (LSA)," which is issued monthly, and the "Cumulative List of Parts Affected," which appears in the Reader Aids section of the daily Federal Register. These two lists will identify the Federal Register page number of the latest amendment of any given rule.

EFFECTIVE AND EXPIRATION DATES

Each volume of the Code contains amendments published in the Federal Register since the last revision of that volume of the Code. Source citations for the regulations are referred to by volume number and page number of the Federal Register and date of publication. Publication dates and effective dates are usually not the same and care must be exercised by the user in determining the actual effective date. In instances where the effective date is beyond the cut-off date for the Code a note has been inserted to reflect the future effective date. In those instances where a regulation published in the Federal Register states a date certain for expiration, an appropriate note will be inserted following the text.

OMB CONTROL NUMBERS

The Paperwork Reduction Act of 1980 (Pub. L. 96-511) requires Federal agencies to display an OMB control number with their information collection request.

Many agencies have begun publishing numerous OMB control numbers as amendments to existing regulations in the CFR. These OMB numbers are placed as close as possible to the applicable recordkeeping or reporting requirements.

OBSOLETE PROVISIONS

Provisions that become obsolete before the revision date stated on the cover of each volume are not carried. Code users may find the text of provisions in effect on a given date in the past by using the appropriate numerical list of sections affected. For the period before April 1, 2001, consult either the List of CFR Sections Affected, 1949–1963, 1964–1972, 1973–1985, or 1986–2000, published in eleven separate volumes. For the period beginning April 1, 2001, a “List of CFR Sections Affected” is published at the end of each CFR volume.

“[RESERVED]” TERMINOLOGY

The term “[Reserved]” is used as a place holder within the Code of Federal Regulations. An agency may add regulatory information at a “[Reserved]” location at any time. Occasionally “[Reserved]” is used editorially to indicate that a portion of the CFR was left vacant and not accidentally dropped due to a printing or computer error.

INCORPORATION BY REFERENCE

What is incorporation by reference? Incorporation by reference was established by statute and allows Federal agencies to meet the requirement to publish regulations in the Federal Register by referring to materials already published elsewhere. For an incorporation to be valid, the Director of the Federal Register must approve it. The legal effect of incorporation by reference is that the material is treated as if it were published in full in the Federal Register (5 U.S.C. 552(a)). This material, like any other properly issued regulation, has the force of law.

What is a proper incorporation by reference? The Director of the Federal Register will approve an incorporation by reference only when the requirements of 1 CFR part 51 are met. Some of the elements on which approval is based are:

- (a) The incorporation will substantially reduce the volume of material published in the Federal Register.
- (b) The matter incorporated is in fact available to the extent necessary to afford fairness and uniformity in the administrative process.
- (c) The incorporating document is drafted and submitted for publication in accordance with 1 CFR part 51.

What if the material incorporated by reference cannot be found? If you have any problem locating or obtaining a copy of material listed as an approved incorporation by reference, please contact the agency that issued the regulation containing that incorporation. If, after contacting the agency, you find the material is not available, please notify the Director of the Federal Register, National Archives and Records Administration, 8601 Adelphi Road, College Park, MD 20740-6001, or call 202-741-6010.

CFR INDEXES AND TABULAR GUIDES

A subject index to the Code of Federal Regulations is contained in a separate volume, revised annually as of January 1, entitled CFR INDEX AND FINDING AIDS. This volume contains the Parallel Table of Authorities and Rules. A list of CFR titles, chapters, subchapters, and parts and an alphabetical list of agencies publishing in the CFR are also included in this volume.

An index to the text of “Title 3—The President” is carried within that volume.

The Federal Register Index is issued monthly in cumulative form. This index is based on a consolidation of the “Contents” entries in the daily Federal Register.

A List of CFR Sections Affected (LSA) is published monthly, keyed to the revision dates of the 50 CFR titles.

REPUBLICATION OF MATERIAL

There are no restrictions on the republication of material appearing in the Code of Federal Regulations.

INQUIRIES

For a legal interpretation or explanation of any regulation in this volume, contact the issuing agency. The issuing agency’s name appears at the top of odd-numbered pages.

For inquiries concerning CFR reference assistance, call 202–741–6000 or write to the Director, Office of the Federal Register, National Archives and Records Administration, 8601 Adelphi Road, College Park, MD 20740-6001 or e-mail fedreg.info@nara.gov.

SALES

The Government Printing Office (GPO) processes all sales and distribution of the CFR. For payment by credit card, call toll-free, 866-512-1800, or DC area, 202-512-1800, M-F 8 a.m. to 4 p.m. e.s.t. or fax your order to 202-512-2104, 24 hours a day. For payment by check, write to: US Government Printing Office – New Orders, P.O. Box 979050, St. Louis, MO 63197-9000.

ELECTRONIC SERVICES

The full text of the Code of Federal Regulations, the LSA (List of CFR Sections Affected), The United States Government Manual, the Federal Register, Public Laws, Public Papers of the Presidents of the United States, Compilation of Presidential Documents and the Privacy Act Compilation are available in electronic format via www.ofr.gov. For more information, contact the GPO Customer Contact Center, U.S. Government Printing Office. Phone 202-512-1800, or 866-512-1800 (toll-free). E-mail, gpo@custhelp.com.

The Office of the Federal Register also offers a free service on the National Archives and Records Administration’s (NARA) World Wide Web site for public law numbers, Federal Register finding aids, and related information. Connect to NARA’s web site at www.archives.gov/federal-register.

RAYMOND A. MOSLEY,
Director,
Office of the Federal Register.
April 1, 2011.

THIS TITLE

Title 24—HOUSING AND URBAN DEVELOPMENT is composed of five volumes. The first four volumes containing parts 0–199, parts 200–499, parts 500–699, parts 700–1699, represent the regulations of the Department of Housing and Urban Development. The fifth volume, containing part 1700 to end, continues with regulations of the Department of Housing and Urban Development and also includes regulations of the Board of Directors of the Hope for Homeowners Program, and the Neighborhood Reinvestment Corporation. The contents of these volumes represent all current regulations codified under this title of the CFR as of April 1, 2011.

For this volume, Bonnie Fritts was Chief Editor. The Code of Federal Regulations publication program is under the direction of Michael L. White, assisted by Ann Worley.

Title 24—Housing and Urban Development

(This book contains part 1700 to End)

SUBTITLE B—REGULATIONS RELATING TO HOUSING AND URBAN DEVELOPMENT (CONTINUED)

	<i>Part</i>
CHAPTER X—Office of Assistant Secretary for Housing—Federal Housing Commissioner, Department of Housing and Urban Development (Interstate Land Sales Registration Program)	1710
CHAPTER XII—Office of Inspector General, Department of Housing and Urban Development	2002
CHAPTER XV—Emergency Mortgage Insurance and Loan Programs, Department of Housing and Urban Development ...	2700
CHAPTER XX—Office of Assistant Secretary for Housing—Federal Housing Commissioner, Department of Housing and Urban Development	3280
CHAPTER XXIV—Board of Directors of the Hope for Homeowners Program	4001
CHAPTER XXV—Neighborhood Reinvestment Corporation	4100

Subtitle B—Regulations
Relating to Housing and
Urban Development
(Continued)

CHAPTER X—OFFICE OF ASSISTANT
SECRETARY FOR HOUSING—FEDERAL
HOUSING COMMISSIONER, DEPARTMENT OF
HOUSING AND URBAN DEVELOPMENT
(INTERSTATE LAND SALES REGISTRATION
PROGRAM)

<i>Part</i>		<i>Page</i>
1700–1709	[Reserved]	
1710	Land registration	7
1715	Purchasers' revocation rights, sales practices and standards	64
1720	Formal procedures and rules of practice	68

PARTS 1700–1709 [RESERVED]

PART 1710—LAND REGISTRATION

Subpart A—General Requirements

- Sec.
- 1710.1 Definitions.
 - 1710.3 General applicability.
 - 1710.4 Exemptions—general.
 - 1710.5 Statutory exemptions from the provisions of this chapter.
 - 1710.6 One hundred lot exemption.
 - 1710.7 Twelve lot exemption.
 - 1710.8 Scattered site subdivisions.
 - 1710.9 Twenty acre lots.
 - 1710.10 Single-family residence exemption.
 - 1710.11 Manufactured home exemption.
 - 1710.12 Intrastate exemption.
 - 1710.13 Metropolitan Statistical Area (MSA) exemption.
 - 1710.14 Regulatory exemptions.
 - 1710.15 Regulatory exemption—multiple site subdivision—determination required.
 - 1710.16 Regulatory exemption—determination required.
 - 1710.17 Advisory opinion.
 - 1710.18 No action letter.
 - 1710.20 Requirements for registering a subdivision—Statement of Record—filing and form.
 - 1710.21 Effective dates.
 - 1710.22 Statement of record—initial or consolidated.
 - 1710.23 Amendment—filing and form.
 - 1710.29 Use of property report—misstatements, omissions or representation of HUD approval prohibited.
 - 1710.35 Payment of fees.
 - 1710.45 Suspensions.

Subpart B—Reporting Requirements

- 1710.100 Statement of Record—format.
- 1710.102 General instructions for completing the Statement of Record.
- 1710.103 Developer obligated improvements.
- 1710.105 Cover page.
- 1710.106 Table of contents.
- 1710.107 Risks of buying land.
- 1710.108 General information.
- 1710.109 Title to the property and land use.
- 1710.110 Roads.
- 1710.111 Utilities.
- 1710.112 Financial information.
- 1710.113 Local services.
- 1710.114 Recreational facilities.
- 1710.115 Subdivision characteristics and climate.
- 1710.116 Additional information.
- 1710.117 Cost sheet, signature of Senior Executive Officer.
- 1710.118 Receipt, agent certification and cancellation page.
- 1710.200 Instructions for Statement of Record, Additional Information and Documentation.

- 1710.208 General information.
- 1710.209 Title and land use.
- 1710.210 Roads.
- 1710.211 Utilities.
- 1710.212 Financial information.
- 1710.214 Recreational facilities.
- 1710.215 Subdivision characteristics and climate.
- 1710.216 Additional information.
- 1710.219 Affirmation.
- 1710.310 Annual report of activity.

Subpart C—Certification of Substantially Equivalent State Law

- 1710.500 General.
- 1710.503 Notice of certification.
- 1710.504 Cooperation among certified states and between certified states and the Secretary.
- 1710.505 Withdrawal of State certification.
- 1710.506 State/Federal filing requirements.
- 1710.507 Effect of suspension or withdrawal of certification granted under §1710.501(a): Full disclosure requirement.
- 1710.508 Effect of suspension of certification granted under §1710.501(b): Sufficient protection requirement.
- 1710.552 Previously accepted state filings.
- 1710.556 Previously accepted state filings—amendments and consolidations.
- 1710.558 Previously accepted state filings—notice of revocation rights on property report cover page.
- 1710.559 Previously accepted state filings—notice of revocation rights in contracts and agreements.

AUTHORITY: 15 U.S.C. 1718; 42 U.S.C. 3535(d).

Subpart A—General Requirements

AUTHORITY: Sec. 1419, Interstate Land Sales Full Disclosure Act, 82 Stat. 590, 598; 15 U.S.C. 1718; sec. 7(d), Dept. of Housing and Urban Development Act, 42 U.S.C. 3535(d).

§ 1710.1 Definitions.

(a) *Statutory terms.* All terms are used in accordance with their statutory meaning in 15 U.S.C. 1702 or with part 5 of this title, unless otherwise defined in paragraph (b) of this section or elsewhere in this part.

(b) *Other terms.* As used in this part: *Act* means the Interstate Land Sales Full Disclosure Act, 15 U.S.C. 1701.

Advisory opinion means the formal written opinion of the Secretary as to jurisdiction in a particular case or the applicability of an exemption under §§1710.5 through 1710.15, based on facts submitted to the Secretary.

§ 1710.3

24 CFR Ch. X (4–1–11 Edition)

Available for use means that in addition to being constructed, the subject facility is fully operative and supplied with any materials and staff necessary for its intended purpose.

Beneficial property restrictions means restrictions that are enforceable by the lot owners and are designed to control the use of the lot and to preserve or enhance the environment and the aesthetic and economic value of the subdivision.

Date of filing means the date a Statement of Record, amendment, or consolidation, accompanied by the applicable fee, is received by the Secretary.

Good faith estimate means an estimate based on documentary evidence. In the case of cost estimates, the documentation may be obtained from the suppliers of the services. In the case of estimates of completion dates, the documentation may be actual contracts let, engineering schedules, or other evidence of commitments to complete the amenities.

Lot means any portion, piece, division, unit, or undivided interest in land located in any State or foreign country, if the interest includes the right to the exclusive use of a specific portion of the land.

OILSR means the Interstate Land Sales Registration program.

Owner means the person or entity who holds the fee title to the land and has the power to convey that title to others.

Parent corporation means that entity which ultimately controls the subsidiary, even though the control may arise through any series or chain of other subsidiaries or entities.

Principal means any person or entity holding at least a 10 percent financial or ownership interest in the developer or owner, directly or through any series or chain of subsidiaries or other entities.

Rules means all rules adopted pursuant to the Act, including the general requirements published in this part.

Sale means any obligation or arrangement for consideration to purchase or lease a lot directly or indirectly. The terms “sale” or “seller” include in their meanings the terms “lease” and “lessor”.

Senior Executive Officer means the individual of highest rank responsible for the day-to-day operations of the developer and who has the authority to bind or commit the developing entity to contractual obligations.

Site means a group of contiguous lots, whether such lots are actually divided or proposed to be divided. Lots are considered to be contiguous even though contiguity may be interrupted by a road, park, small body of water, recreational facility, or any similar object.

Start of construction means breaking ground for building a facility, followed by diligent action to complete the facility.

[61 FR 13597, Mar. 27, 1996]

§ 1710.3 General applicability.

Except in the case of an exempt transaction, a developer may not sell or lease lots in a subdivision, making use of any means or instruments of transportation or communication in interstate commerce, or of the mails, unless a Statement of Record is in effect in accordance with the provisions of this part. In non-exempt transactions, the developer must give each purchaser a printed Property Report, meeting the requirements of this part, in advance of the purchaser’s signing of any contract or agreement for sale or lease.

(Approved by the Office of Management and Budget under control number 2502-0243)

[45 FR 40479, June 13, 1980, as amended at 49 FR 31368, Aug. 6, 1984]

§ 1710.4 Exemptions—general.

(a) The exemptions available under §§ 1710.5 through 1710.16 are not applicable when the method of sale, lease or other disposition of land or an interest in land is adopted for the purpose of evasion of the Act.

(b) With the exception of the sales or leases which are exempt under § 1710.5, the anti-fraud provisions of the Act (15 U.S.C. 1703(a)(2)) apply to exempt transactions. The anti-fraud provisions make it unlawful for a developer or agent to employ any device, scheme, or artifice to:

- (1) Defraud;

Office of Asst. Sec. for Housing, HUD

§ 1710.7

(2) To obtain money or property by means of any untrue statement of a material fact, or

(3) To omit to state a material fact necessary in order to make the statements made not misleading, with respect to any information pertinent to the lot or subdivision; or

(4) To engage in any transaction, practice, or course of business which operates or would operate as a fraud or deceit upon a purchaser.

(c) The anti-fraud provisions of the Act require that certain representations be included in the contract in transactions which are not exempt under §1710.5. Specifically, the Act requires that if a developer or agent represents that roads, sewers, water, gas or electric service or recreational amenities will be provided or completed by the developer, the contract must stipulate that the services or amenities will be provided or completed. See §1715.15(f).

(d) Eligibility for exemptions available under §§1710.5 through 1710.14 is self-determining. With the exception of the exemptions available under §§1710.15 and 1710.16, a developer is not required to file notice with or obtain the approval of the Secretary in order to take advantage of an exemption. If a developer elects to take advantage of an exemption, the developer is responsible for maintaining records to demonstrate that the requirements of the exemption have been met.

(e) A developer may present evidence, or otherwise discuss, in an informal hearing before the OILSR Administrator or designee, the Department's position on the jurisdiction or non-exempt status of a particular subdivision.

[45 FR 40479, June 13, 1980, as amended at 54 FR 40866, Oct. 4, 1989]

§ 1710.5 Statutory exemptions from the provisions of this chapter.

A listing of the statutory exemptions is contained in 15 U.S.C. 1703. In accordance with 15 U.S.C. 1703(a)(2), if the sale involves a condominium or multi-unit construction, a presale clause conditioning the sale of a unit on a certain percentage of sales of other units is permissible if it is legally binding on the parties and is for a period not to exceed 180 days. However, the 180-day

provision cannot extend the 2-year period for performance. The permissible 180 days is calculated from the date the first purchaser signs a sales contract in the project or, if a phased project, from the date the first purchaser signs the first sales contract in each phase.

[61 FR 13597, Mar. 27, 1996]

§ 1710.6 One hundred lot exemption.

The sale of lots in a subdivision is exempt from the registration requirements of the Act if, since April 28, 1969, the subdivision has contained fewer than 100 lots, exclusive of lots which are exempt from jurisdiction under §1710.5. In the sale of lots in the subdivision that are not exempt under §1710.5, the developer must comply with the Act's anti-fraud provisions, set forth in §1710.4 (b) and (c).

[49 FR 31368, Aug. 6, 1984]

§ 1710.7 Twelve lot exemption.

(a) The sale of lots is exempt from the registration requirements of the Act if, beginning with the first sale after June 20, 1980, no more than twelve lots in the subdivision are sold in the subsequent twelve-month period. Thereafter, the sale of the first twelve lots is exempt from the registration requirements if no more than twelve lots were sold in each previous twelve month period which began with the anniversary date of the first sale after June 20, 1980.

(b) A developer may apply to the Secretary to establish a different twelve month period for use in determining eligibility for the exemption and the Secretary may allow the change if it is for good cause and consistent with the purpose of this section.

(c) In determining eligibility for this exemption, all lots sold or leased in the subdivision after June 20, 1980, are counted, whether or not the transactions are otherwise exempt. Sales or leases made prior to June 21, 1980, are not considered in determining eligibility for the exemption.

(d) The sale must also comply with the anti-fraud provisions of §1710.4 (b) and (c) of this part.

[45 FR 40479, June 13, 1980, as amended at 49 FR 31368, Aug. 6, 1984]

§ 1710.8

24 CFR Ch. X (4-1-11 Edition)

§ 1710.8 Scattered site subdivisions.

(a) The sale of lots in a subdivision consisting of noncontiguous parts is exempt from the registration requirements of the Act if—

(1) Each noncontiguous part of the subdivision contains twenty or fewer lots; and

(2) Each purchaser or purchaser's spouse makes a personal, on-the-lot inspection of the lot purchased prior to signing a contract.

(b) For purposes of this exemption, interruptions such as roads, parks, small bodies of water or recreational facilities do not serve to break the contiguity of parts of a subdivision.

(c) The sale must also comply with the anti-fraud provisions of § 1710.4 (b) and (c) of this part.

[45 FR 40479, June 13, 1980, as amended at 49 FR 31368, Aug. 6, 1984]

§ 1710.9 Twenty acre lots.

(a) The sale of lots in a subdivision is exempt from the registration requirements of the Act if, since April 28, 1969, each lot in the subdivision has contained at least twenty acres. In determining eligibility for the exemption, easements for ingress and egress or public utilities are considered part of the total acreage of the lot if the purchaser retains ownership of the property affected by the easement.

(b) The sale must also comply with the anti-fraud provisions of § 1710.4 (b) and (c) of this part.

[45 FR 40479, June 13, 1980, as amended at 49 FR 31368, Aug. 6, 1984]

§ 1710.10 Single-family residence exemption.

(a) *General.* The sale of a lot which meets the requirements specified under paragraphs (b) and (c) of this section is exempt from the registration requirements of the Act.

(b) *Subdivision requirements.* (1) The subdivision must meet all local codes and standards.

(2) In the promotion of the subdivision there must be no offers, by direct mail or telephone solicitation, of gifts, trips, dinners or use of similar promotional techniques to induce prospective purchasers to visit the subdivision or to purchase a lot.

(c) *Lot requirements.* (1) The lot must be located within a municipality or county where a unit of local government or the State specifies minimum standards in the following areas for the development of subdivision lots taking place within its boundaries:

(i) Lot dimensions.

(ii) Plat approval and recordation.

(iii) Roads and access.

(iv) Drainage.

(v) Flooding.

(vi) Water supply.

(vii) Sewage disposal.

(2) Each lot sold under the exemption must be either zoned for single-family residences or, in the absence of a zoning ordinance, limited exclusively by enforceable covenants or restrictions to single-family residences. Manufactured homes, townhouses, and residences for one-to-four family use are considered single-family residences for purposes of this exemption provision.

(3) The lot must be situated on a paved street or highway which has been built to standards established by the State or the unit of local government in which the subdivision is located. If the roads are to be public roads they must be acceptable to the unit of local government that will be responsible for maintenance. If the street or highway is not complete, the developer must post a bond or other surety acceptable to the municipality or county in the full amount of the cost of completing the street or highway to assure completion to local standards. For purposes of this exemption, *paved* means concrete or pavement with a bituminous surface that is impervious to water, protects the base and is durable under the traffic load and maintenance contemplated.

(4) The unit of local government or a homeowners association must have accepted or be obligated to accept the responsibility for maintaining the street or highway upon which the lot is situated. In any case in which a homeowners association has accepted or is obligated to accept maintenance responsibility, the developer must, prior to signing of a contract or agreement to purchase, provide the purchaser with a good faith written estimate of

the cost of carrying out the responsibility over the first ten years of ownership.

(5) At the time of closing, potable water, sanitary sewage disposal, and electricity must be extended to the lot or the unit of local government must be obligated to install the facilities within 180 days following closing. For subdivisions which will not have a central water or sewage disposal system, there must be assurances that an adequate potable water supply is available year-round and that the lot is approved for the installation of a septic tank.

(6) The contract of sale must require delivery within 180 days after the signing of the sales contract of a warranty deed, which at the time of delivery is free from monetary liens and encumbrances. If a warranty deed is not commonly used in the jurisdiction where the lot is located, a deed or grant which warrants that the seller has not conveyed the lot to another person may be delivered in lieu of a warranty deed. The deed or grant used must warrant that the lot is free from encumbrances made by the seller or any other person claiming by, through, or under the seller.

(7) At the time of closing, a title insurance binder or title opinion reflecting the condition of title must be in existence and issued or presented to the purchaser showing that, subject only to exceptions which are approved in writing by the purchaser at the time of closing, marketable title to the lot is vested in the seller.

(8) The purchaser or purchaser's spouse must make a personal, on-the-lot inspection of the lot purchased prior to signing a contract or agreement to purchase.

(d) The sale must also comply with the anti-fraud provisions of §1710.4 (b) and (c) of this part.

[45 FR 40479, June 13, 1980, as amended at 49 FR 31368, Aug. 6, 1984; 50 FR 9269, Mar. 7, 1985]

§ 1710.11 Manufactured home exemption.

(a) The sale of a lot is exempt from the registration requirements of the Act when the following eligibility requirements are met:

(1) The lot is sold as a homesite by one party and a manufactured home is

sold by another party and the contracts of sale—

(i) Obligate the sellers to perform, contingent upon the other seller carrying out its obligations so that a completed manufactured home will be erected on a completed homesite within two years after the date the purchaser signed the contract to purchase the lot;

(ii) Provide that all funds received by the sellers are to be deposited in escrow accounts independent of the sellers until the transactions are completed;

(iii) Provide that funds received by the sellers will be released to the buyer upon demand if the lot on which the manufactured home has been erected is not conveyed within two years; and

(iv) Contain no provisions which restrict the purchaser's remedy of bringing suit for specific performance.

(2) The homesite is developed in conformance with all local codes and standards, if any, for manufactured home subdivisions.

(3) At the time of closing—

(i) Potable water and sanitary sewage disposal are available to the homesite and electricity has been extended to the lot line;

(ii) The homesite is accessible by roads;

(iii) The purchaser receives marketable title to the lot; and

(iv) Other common facilities represented in any manner by the developer or agent to be provided are completed or there are letters of credit, cash escrows or surety bonds in the form acceptable to the local government in an amount equal to 100 percent of the estimated cost of completion. Corporate bonds are not acceptable for purposes of the exemption.

(4) For purposes of this section, a manufactured home is a unit receiving a label in conformance with HUD regulations implementing the National Manufactured Housing Construction and Safety Standards Act of 1974 (42 U.S.C. 5401).

(b) The sale must also comply with the anti-fraud provisions of §1710.4 (b) and (c) of this part.

[45 FR 40479, June 13, 1980, as amended at 49 FR 31368, Aug. 6, 1984; 49 FR 33644, Aug. 24, 1984; 50 FR 9269, Mar. 7, 1985]

§ 1710.12

24 CFR Ch. X (4-1-11 Edition)

§ 1710.12 Intrastate exemption.

(a) *Eligibility requirements.* The sale of a lot is exempt from the registration requirements of the Act if the following requirements are met:

(1) The sale of lots in the subdivision after December 20, 1979, is restricted solely to residents of the State in which the subdivision is located unless the sale is exempt under § 1710.5, § 1710.11 or § 1710.13.

(2) The purchaser or purchaser's spouse makes a personal on-the-lot inspection of the lot to be purchased before signing a contract.

(3) Each contract—

(i) Specifies the developer's and purchaser's responsibilities for providing and maintaining roads, water and sewer facilities and any existing or promised amenities;

(ii) Contains a good faith estimate of the year in which the roads, water and sewer facilities and promised amenities will be completed; and

(iii) Contains a non-waivable provision giving the purchaser the opportunity to revoke the contract until at least midnight of the seventh calendar day following the date the purchaser signed the contract. If the purchaser is entitled to a longer revocation period by operation of State law, that period becomes the Federal revocation period and the contract must reflect the requirements of the longer period.

(4) The lot being sold is free and clear of all liens, encumbrances and adverse claims except the following:

(i) Mortgages or deeds of trust which contain release provisions for the individual lot purchased if—

(A) The contract of sale obligates the developer to deliver, within 180 days, a warranty deed (or its equivalent under local law), which at the time of delivery is free from any monetary liens or encumbrances; and

(B) The purchaser's payments are deposited in an escrow account independent of the developer until a deed is delivered.

(ii) Liens which are subordinate to the leasehold interest and do not affect the lessee's right to use or enjoy the lot.

(iii) Property reservations which are for the purpose of bringing public serv-

ices to the land being developed, such as easements for water and sewer lines.

(iv) Taxes or assessments which constitute liens before they are due and payable if imposed by a State or other public body having authority to assess and tax property or by a property owners' association.

(v) Beneficial property restrictions that are mutually enforceable by the lot owners in the subdivision. Restrictions, whether separately recorded or incorporated into individual deeds, must be applied uniformly to every lot or group of lots. To be considered beneficial and enforceable, any restriction or covenant that imposes an assessment on lot owners must apply to the developer on the same basis as other lot owners. Developers who maintain control of a subdivision through a Property Owners' Association, Architectural Control Committee, restrictive covenant or otherwise, shall transfer such control to the lot owners no later than when the developer ceases to own a majority of total lots in, or planned for, the subdivision. Relinquishment of developer control shall require affirmative action, usually in the form of an election based upon one vote per lot.

(vi) Reservations contained in United States land patents and similar Federal grants or reservations.

(5) Prior to the sale the developer discloses in a written statement to the purchaser all qualifying liens, reservations, taxes, assessments and restrictions applicable to the lot purchased. The developer must obtain a written receipt from the purchaser acknowledging that the statement required by this subparagraph was delivered to the purchaser.

(6) Prior to the sale the developer provides in a written statement good faith estimates of the cost to the purchaser of providing electric, water, sewer, gas and telephone service to the lot. The estimates for unsold lots must be updated every two years or more frequently if the developer has reason to believe that significant cost increases have occurred. The dates on which the estimates were made must be included in the statement. The developer must obtain a written receipt from the purchaser acknowledging that

the statement required by this subparagraph was delivered to the purchaser.

(b) *Intrastate Exemption Statement.* To satisfy the requirements of paragraphs (a)(5) and (a)(6) of this section, an Intrastate Exemption Statement containing the information prescribed in each such paragraph shall be given to each purchaser. A State-approved disclosure document may be used to satisfy this requirement if all the information required by paragraphs (a)(5) and (a)(6) of this section is included in this disclosure. In such a case, the developer must obtain a written receipt from the purchaser and comply with all other requirements of the exemption. To be acceptable for purposes of the exemption, the statement(s) given to purchasers must contain neither advertising nor promotion on behalf of the developer or subdivision nor references to the U.S. Department of Housing and Urban Development. A sample Intrastate Exemption Statement is included in the exemption guidelines.

(c) The sale must also comply with the anti-fraud provisions of § 1710.4 (b) and (c) of this part.

[45 FR 40479, June 13, 1980, as amended at 49 FR 31368, 31369, Aug. 6, 1984]

§ 1710.13 Metropolitan Statistical Area (MSA) exemption.

(a) *Eligibility requirements.* The sale of a lot which meets the following requirements is exempt from registration requirements of the Act:

(1) The lot is in a subdivision which contains fewer than 300 lots and has contained fewer than 300 lots since April 28, 1969.

(2) The lot is located within a Metropolitan Statistical Area (MSA) as defined by the Office of Management and Budget and characterized in paragraph (b) of this section.

(3) The principal residence of the purchaser is within the same MSA as the subdivision.

(4) The purchaser or purchaser's spouse makes a personal on-the-lot inspection of the lot to be purchased prior to signing a contract or agreement.

(5) Each contract—

(i) Specifies the developer's and purchaser's responsibilities for providing

and maintaining roads, water and sewer facilities and any existing or promised amenities;

(ii) Contains a good faith estimate of the year in which the roads, water and sewer facilities and promised amenities will be completed;

(iii) Contains a nonwaivable provision giving the purchaser the opportunity to revoke the contract until at least midnight of the seventh calendar day following the date the purchaser signed the contract, or, if the purchaser is entitled to a longer revocation period by operation of State law, that period becomes the Federal revocation period and the contract must reflect the requirements of the longer period.

(6) The lot being sold must be free and clear of liens such as mortgages, deeds of trust, tax liens, mechanics' liens, or judgments. For purposes of this exemption, the term *liens* does not include the following:

(i) Mortgages or deeds of trust which contain release provisions for the individual lot purchased if—

(A) The contract of sale obligates the developer to deliver, within 180 days, a warranty deed (or its equivalent under local law), which at the time of delivery is free from any monetary liens or encumbrances; and

(B) The purchaser's payments are deposited in an escrow account independent of the developer until a deed is delivered.

(ii) Liens which are subordinate to the leasehold interest and do not affect the lessee's right to use or enjoy the lot.

(iii) Property reservations which are for the purpose of bringing public services to the land being developed, such as easements for water and sewer lines.

(iv) Taxes or assessments which constitute liens before they are due and payable if imposed by a State or other public body having authority to assess and tax property or by a property owners' association.

(v) Beneficial property restrictions that are mutually enforceable by the lot owners in the subdivision. Restrictions, whether separately recorded or incorporated into individual deeds, must be applied uniformly to every lot

§ 1710.13

24 CFR Ch. X (4-1-11 Edition)

or group of lots. To be considered beneficial and enforceable, any restriction or covenant that imposes an assessment on lot owners must apply to the developer on the same basis as other lot owners. Developers who maintain control of a subdivision through a Property Owners' Association, Architectural Control Committee, restrictive covenants, or otherwise, shall transfer such control to the lot owners no later than when the developer ceases to own a majority of total lots in, or planned for, the subdivision. Relinquishment of developer control shall require affirmative action, usually in the form of an election based upon one vote per lot.

(vi) Reservations contained in United States land patents and similar Federal grants or reservations.

(7) Before the sale the developer gives a written MSA Exemption Statement to the purchaser and obtains a written receipt acknowledging that the statement was received. A sample MSA Exemption Statement is included in the exemption guidelines. A State-approved disclosure document may be used to satisfy this requirement if all of the information required by this section is included. The statement(s) given to purchasers must contain neither advertising nor promotion on behalf of the developer or the subdivision nor references to the U.S. Department of Housing and Urban Development. In descriptive and concise terms, the statement that the developer must give the purchaser shall disclose the following:

(i) All liens, reservations, taxes, assessments, beneficial property restrictions which are enforceable by other lot owners in the subdivision, and adverse claims which are applicable to the lot to be purchased.

(ii) Good faith estimates of the cost to the purchaser of providing electric, water, sewer, gas and telephone service to the lot. The estimates for unsold lots must be updated every two years, or more frequently if the developer has reason to believe that significant cost increases have occurred. The dates on which the estimates were made must be included in the statement.

(8) The developer executes and gives to the purchaser a written instrument

designating a person within the State of residence of the purchaser as the developer's agent for service of process. The developer must also acknowledge in writing that it submits to the legal jurisdiction of the State in which the purchaser or lessee resides.

(9) The developer executes a written affirmation for each sale made under this exemption. By January 31 of each year, the developer submits to the Secretary a copy of the executed affirmation for each sale made during the preceding calendar year or a master affirmation in which are listed all purchasers' names and addresses and the identity of the lots purchased. Individual affirmations must be available for the Secretary's review at all times during the year.

The affirmation must be in the following form:

Developer's Name _____
Developer's Address _____
Purchaser's Name(s) _____
Purchaser's Address(es) (including county) _____
Name of Subdivision _____
Legal Description of Lot(s) Purchased _____

I hereby affirm that all of the requirements of the MSA exemption as set forth in 15 U.S.C. 1702(b)(8) and 24 CFR 1710.13 have been met in the sale or lease of the lot(s) described above.

I also affirm that I submit to the jurisdiction of the Interstate Land Sales Full Disclosure Act with regard to the sale or lease cited above.

(Date) _____
(Signature of Developer or Authorized Agent) _____

(Title) _____

(b) *Metropolitan Statistical Area.* Metropolitan Statistical Areas are defined by the Office of Management and Budget generally on the basis of population statistics reported in a census. To determine whether a subdivision is located within an MSA and the boundaries of an MSA, contact the Office of Information and Regulatory Affairs, Office of Management and Budget, 726 Jackson Place, NW., Washington, DC 20503.

(c) The sale must also comply with the anti-fraud provisions of §1710.4 (b) and (c).

[45 FR 40479, June 13, 1980, as amended at 49 FR 31369, Aug. 6, 1984]

§ 1710.14 Regulatory exemptions.

(a) *Eligibility requirements.* The following transactions are exempt from the registration requirements of the Act unless the Secretary has terminated the exemption in accordance with paragraph (b) of this section.

(1) The sale of lots, each of which will be sold for less than \$100, including closing costs, if the purchaser will not be required to purchase more than one lot.

(2) The lease of lots for a term not to exceed five years if the terms of the lease do not obligate the lessee to renew.

(3) The sale of lots to a person who is engaged in a bona fide land sales business.

(4) The sale of a lot to a person who owns the contiguous lot which has a residential, commercial or industrial building on it.

(5) The sale of real estate to a government or government agency.

(6) The sale of a lot to a person who has leased and resided primarily on the lot for at least the year preceeding the sale.

(b) *Termination.* If the Secretary has reasonable grounds to believe that exemption from the registration requirements in a particular case is not in the public interest, the Secretary may, after issuing a notice and giving the respondent an opportunity to request a hearing within fifteen days of receipt of the notice, terminate eligibility for exemption. The basis for issuing a notice may be the conduct of the developer or agent, such as unlawful conduct or insolvency, or adverse information about the lots or real estate that should be disclosed to the purchasers. Proceedings will be governed by § 1720.238.

(c) The sale must also comply with the anti-fraud provisions of § 1710.4 (b) and (c) of this part.

[45 FR 40479, June 13, 1980, as amended at 49 FR 31370, Aug. 6, 1984]

§ 1710.15 Regulatory exemption—multiple site subdivision—determination required.

(a) *General.* (1) The sale of lots contained in multiple sites of fewer than 100 lots each, offered pursuant to a single common promotional plan, is ex-

empt from the registration requirements.

(2) For purposes of this exemption, the sale of lots in an individual site that exceeds 99 lots is not exempt from registration. Likewise, the sale of lots in a site containing fewer than 100 lots, where the developer either owns contiguous land or holds an option or other evidence of intent to acquire contiguous land which, when taken cumulatively, would or could result in one site of 100 or more lots, is not exempt from registration. Furthermore, the sale of lots that are within a subdivision established by a separate developer is not exempt from registration by this provision.

(b) *Eligibility requirements.* The sale of each lot must meet the following requirements to be eligible for this exemption.

(1) The lot is sold “as is” with all advertised improvements and amenities completed and in the condition advertised.

(2) The lot is in conformance with all local codes and standards.

(3) The lot is accessible, both legally and physically. For lots which are advertised or otherwise represented as “residential”, either primary or secondary, with any inference that a permanent or temporary dwelling unit of any description (excluding collapsible tents) can be built or installed, physical access must be available by automobile, pick-up truck or equivalent “on-road” vehicle.

(4) At the time of closing, a title insurance binder or title opinion reflecting the condition of title must be issued to the purchaser showing that, subject only to exceptions approved in writing by the purchaser at the time of closing, marketable title is vested in the seller.

(5) Each contract or agreement and any promissory notes—

(i) Contain the following non-waivable provision in bold face type (which must be distinguished from the type used for the rest of the document) on the face or signature page above all signatures:

You have the option to cancel your contract or agreement of sale by notice to the

§ 1710.15

24 CFR Ch. X (4-1-11 Edition)

seller until midnight of the seventh day following the date of signing of the contract or agreement.

If you did not receive a Lot Information Statement prepared pursuant to the rules and regulations of the Interstate Land Sales Registration Division, U.S. Department of Housing and Urban Development, in advance of your signing the contract or agreement, the contract or agreement of sale may be cancelled at your option for two years from the date of signing.

If the purchaser is entitled to a longer revocation period by operation of state or local law, that period becomes the Federal revocation period and the contract must reflect the requirement of the longer period rather than the seven days. The revocation provisions may not be limited or qualified in the contract or other document by requiring a specific type of notice or by requiring that notice be given at a specified place.

(ii) Obligate the developer to deliver, within 180 days, a warranty deed (or its equivalent under local law) for the lot which at the time of delivery is free from any monetary liens or encumbrances.

(6) The purchaser or purchaser's spouse makes a personal on-the-lot inspection of the lot to be purchased before signing a contract.

(7) The purchaser's payments are deposited in an escrow account independent of the developer until a deed is delivered.

(8) Prior to the purchaser signing a contract or agreement of sale, the developer discloses in a written Lot Information Statement all liens, reservations, taxes, assessments, easements and restrictions applicable to the lot purchased (see paragraph (b)(11) of this section).

(9) Prior to the purchaser signing a contract or agreement of sale, the developer discloses in a written Lot Information Statement the name, address and telephone number of the local governmental agency or agencies from which information on permits or other requirements for water, sewer and electrical installations can be obtained. This Statement will also contain the name, address and telephone number of the suppliers which would or could provide the foregoing services.

(10) The lot sale must comply with the anti-fraud provisions of 24 CFR 1710.4 (b) and (c) and the sales practices and standards in 24 CFR 1715.10 through 1715.28.

(11) A written Lot Information Statement must be delivered to, and acknowledged by, each purchaser prior to his or her signing a contract or agreement of sale, and must contain the information shown in the format below. The Statement must be typed or printed in at least 10 point font. A copy of the acknowledgement will be maintained by the developer for three years and will be made available to OILSR upon request. If the Statement is not delivered as required, the contract or agreement of sale may be revoked and a full refund paid, at the option of the purchaser, within two years of the signing date and the contract or agreement of sale will clearly provide this right.

SAMPLE FORMAT

(Use of the following headings and first paragraph are mandatory.)

Lot Information Statement

Important: Read Carefully Before Signing Anything

The developer has obtained a regulatory exemption from registration under the Interstate Land Sales Full Disclosure Act. One requirement of that exemption is that you must receive this Statement prior to the time you sign an agreement (contract) to purchase a lot.

Right To Cancel

(Under this heading the developer is to state the specific rescission rights provided for in the contract pursuant to 1710.15(b)(5)(i)).

Risk of Buying Land

(Under this heading the developer is to list the following information:)

There are certain risks in purchasing real estate that you should be aware of. The following are some of those risks:

The future value of land is uncertain and dependent upon many factors. Do not expect all land to automatically increase in value.

Any value which your lot may have will be affected if roads, utilities and/or amenities cannot be completed or maintained.

Office of Asst. Sec. for Housing, HUD

§ 1710.15

Any development will likely have some impact on the surrounding environment. Development which adversely affects the environment may cause governmental agencies to impose restriction on the use of the land.

In the purchase of real estate, many technical requirements must be met to assure that you receive proper title and that you will be able to use the land for its intended purpose. Since this purchase involves a major expenditure of money, it is recommended that you seek professional advice before you obligate yourself.

If adequate provisions have not been made for maintenance of the roads or if the land is not served by publicly maintained roads, you may have to maintain the roads at your expense.

If the land is not served by a central sewage system and/or water system, you should contact the local authorities to determine whether a permit will be given for an on-site sewage disposal system and/or well and whether there is an adequate supply of water. You should also become familiar with the requirements for, and the cost of, obtaining electrical service to the lot.

Developer Information

(Under this heading the developer is to list the following information:)

Developer's Name: _____
 Address: _____
 Telephone Number: _____

Lot Information

(Under this heading the developer is to list the following information:)

Lot Location: _____
 (Enter a statement disclosing all liens, reservations, taxes, assessments, easements and restrictions applicable to the lot. A copy of the restrictions may be attached in lieu of recitation.)

Suppliers of Utilities and Issuers of Permits

(Under this heading the developer is to list the name, address and phone number of the appropriate governmental agency or agencies, if any, that will provide information on permits or other requirements for water, sewer and electrical installations. The information will also contain the name, address and telephone number of the suppliers of such utilities which can provide information to the purchaser on costs and availability of such services. A chart similar to the one below may be used to supply this information.

Listed below are contact points for determining permit requirements, if any, and to obtain information on approximate costs and availability for the listed services:

	Name, Address and Telephone Number of	
	Governmental agency	Supplier
Water.		
Sewer.		
Electricity.		

If misrepresentations are made in the sale of this lot to you, you may have rights under the Interstate Land Sales Full Disclosure Act. If you have evidence of any scheme, artifice or device used to defraud you, you may wish to contact: Interstate Land Sales Registration Division, HUD Building, Room 6278, 451 Seventh Street, SW., Washington, DC 20410.

(The Receipt is to be in the following form:)

SAMPLE RECEIPT FOR LOT INFORMATION STATEMENT

Purchaser (print or type): _____
 Date: _____
 Signature of purchaser: _____
 Street Address: _____
 City: _____
 State: _____
 Zip: _____
 Name of salesperson (print or type): _____
 Signature of salesperson: _____

(c) *Request for Multiple Site Subdivision Exemption.* (1) The developer must file a request for the Multiple Site Subdivision Exemption in the following format. The request must be accompanied by a filing fee of \$500 (prepared in accordance with §1710.35 (a)) and a sample Lot Information Statement.

REQUEST FOR MULTIPLE SITE SUBDIVISION EXEMPTION

Developer:
 Name: _____
 Address: _____
 Telephone No.: _____
 Agent:
 Name: _____
 Address: _____
 Telephone No.: _____

(Insert a general description of the developer's method of operation.)

I affirm that I am, or will be the developer of the property and/or method of operation described above.

I affirm that the lots in said property will be sold in compliance with all of the requirements of 24 CFR 1710.15.

I further affirm that the statements contained in all documents submitted with this request for an Exemption Order are true and complete.

Date: _____
 Signature: _____

§ 1710.16

24 CFR Ch. X (4-1-11 Edition)

Title: _____

WARNING: 18 U.S.C. 1001 provides, among other things, that whoever knowingly and willingly makes or uses a document or writing containing any false, fictitious, or fraudulent statement or entry, in any matter within the jurisdiction of any department or agency of the United States, shall be fined not more than \$10,000 or imprisoned for not more than 5 years or both.

(2) This exemption will become effective upon issuance of an Exemption Order by the Secretary.

(d) *Annual Report.* (1) By January 31 of each year the developer will send a report to the Secretary listing each site and its location available for a sale pursuant to the exemption during the preceding year and indicate the number of lot sales made in each site. The report will describe any changes in the information provided in the Request for the Multiple Site Subdivision Exemption or contain a statement that there are no changes.

(2) The Annual Report must be accompanied by a filing fee of \$100.

(3) The Annual Report must be signed and dated by the developer, attesting to its completeness and accuracy.

(4) Failure to submit the Annual Report within ten days after the receipt of notice from the Secretary will automatically terminate eligibility for the exemption as of the Report due date.

(e) *Termination.* If, subsequent to the issuance of an Exemption Order, the Secretary has reasonable grounds to believe that exemption from the registration requirements in the particular case is not in the public interest, the Secretary may, after issuing a notice and giving the respondent an opportunity to request a hearing within fifteen days of receipt of the notice, terminate the exemption order. The basis for issuing a notice may be apparent omissions or misrepresentations in the documents submitted to the Secretary, the conduct of the developer or agent, such as unlawful conduct or insolvency, or adverse information about the real estate that should be disclosed to purchasers. Proceedings will be governed by 24 CFR 1720.238.

[54 FR 40866, Oct. 4, 1989]

§ 1710.16 Regulatory exemption—determination required.

(a) *General.* The Secretary may exempt from the registration requirements of the Act any subdivision or lots in a subdivision by issuing an order in writing if it is determined that registration is not necessary in the public interest and for the protection of purchasers on the basis of the small amount or limited character of the offering and the requirements contained in paragraph (b) of this section.

(b) *Eligibility requirements.* An exemption order may be issued at the discretion of the Secretary on the basis of the small amount or limited character of the offering if the following requirements are met:

(1) The subdivision or sales substantially meet the requirements of one of the exemptions available under this chapter.

(2) Each contract—

(i) Specifies the developer's and purchaser's responsibilities for providing and maintaining roads, water and sewer facilities and any existing or promised amenities;

(ii) Contains a good faith estimate of the year in which the roads, water and sewer facilities and promised amenities will be completed;

(iii) Contains a non-waivable provision giving the purchaser the opportunity to revoke the contract until at least midnight of the seventh calendar day following the date the purchaser signed the contract. If the purchaser is entitled to a longer revocation period by operation of State law, that period becomes the Federal revocation period and the contract must reflect the requirements of the longer period.

(iv) Contains a provision that obligates the developer to deliver to the purchaser within 180 days of the date the purchaser signed the sales contract, a warranty deed, or its equivalent under local law, which at the time of delivery is free from any monetary liens or encumbrances.

(3) The purchaser or purchaser's spouse makes a personal on-the-lot inspection of the lot to be purchased before signing a contract.

(4) The developer files a request for an exemption order and supporting documentation in accordance with

Office of Asst. Sec. for Housing, HUD

§ 1710.17

paragraphs (c) and (d) of this section and submits a filing fee of \$500.00 in accordance with §1710.35(a) of this part. This fee is not refundable.

(c) Request. The request for an Exemption Order must be in the following format:

REQUEST FOR EXEMPTION ORDER

Subdivision _____
Location (including county) _____
Developer _____
Address _____
Authorized Agent or President of Developer _____
Address _____
Number of Lots Subject to Exemption Request _____
Description of Lots (list lot and block number or other identifying designation) _____

I affirm that I am the developer or owner of the property described above or will be the developer or owner at the time the lots are offered for sale to the public, or that I am the agent authorized by the developer or owner to complete this statement.

I further affirm that the statements contained in all documents submitted with the request for an exemption order are true and complete.

(Date) _____

(Signature of Developer, Owner or Authorized Agent) _____

(Title) _____

WARNING: Section 1418 of the Housing and Urban Development Act of 1968 (83 Stat. 598, 15 U.S.C. 1717 as amended) provides: "any person who willfully violates any of the provisions of this title or the rules and regulations prescribed pursuant thereto * * *, shall upon conviction be fined not more than \$10,000.00 or imprisoned not more than five years, or both."

(d) Supporting documentation. A request for an exemption order must be accompanied by the following documentation:

- (1) A plat of the entire subdivision with the lots subject to the exemption request delineated thereon.
(2) A copy of the contract to be used.
(3) A clear and specific statement detailing how the proposed sales of lots subject to the exemption request substantially complies with one of the available exemption provisions.
(4) A description of the method by which the lots have been and will be promoted and to which population cen-

ters the promotion has been and will be directed.

(e) The sale must also comply with the anti-fraud provisions of §1710.4 (b) and (c) of this part.

(f) Termination. If, subsequent to the issuance of an exemption order, the Secretary has reasonable grounds to believe that exemption from the registration requirements in the particular case is not in the public interest, the Secretary may, after issuing a notice and giving the respondent an opportunity to request a hearing within fifteen days of receipt of the notice, terminate the exemption order. The basis for issuing a notice may be apparent omissions or misrepresentations in the documents submitted to the Secretary, the conduct of the developer or agent, such as unlawful conduct or insolvency, or adverse information about the real estate that should be disclosed to purchasers. Proceedings will be governed by § 1720.238.

[45 FR 40479, June 13, 1980, as amended at 49 FR 31370, 31373, Aug. 6, 1984]

§ 1710.17 Advisory opinion.

(a) General. A developer may request an opinion from the Secretary as to whether an offering qualifies for an exemption or is subject to the jurisdiction of the Act.

(b) Requirements. All requests for Advisory Opinions must be accompanied by the following:

- (1) A \$500.00 filing fee submitted in accordance with §1710.35(a). This fee is not refundable.
(2) A comprehensive description of the conditions and operations of the offering. There is no prescribed format for submitting this information, but the developer should at least cite the applicable statutory or regulatory basis for the exemption or lack of jurisdiction and thoroughly explain how the offering either satisfies the requirements for exemption or falls outside the purview of the Act.
(3) An affirmation as shown below:

Developer's Affirmation

Name of Subdivision _____
Location (Including County and State) _____
Name of Developer _____
Address of Developer _____
Name of Agent _____
Address of Agent _____

§ 1710.18

Number of Lots in Subdivision _____
Number of Acres in Subdivision _____

I affirm that I am the developer or owner of the property described above or will be the developer or owner at the time the lots are offered for sale to the public, or that I am the agent authorized by the developer or owner to complete this statement.

I further affirm that the statements contained in all documents submitted with the request for an Advisory Opinion are true and complete.

(Date)

(Signature)

(Title)

WARNING: Section 1418 of the Housing and Urban Development Act of 1968 (83 Stat. 598, 15 U.S.C. 1717 as amended) provides: "Any person who willfully violates any of the provisions of this title or the rules and regulations prescribed pursuant thereto * * *, shall upon conviction be fined not more than \$10,000.00 or imprisoned not more than five years, or both."

[45 FR 40479, June 13, 1980, as amended at 49 FR 31370, 31373, Aug. 6, 1984]

§ 1710.18 No action letter.

(a) If the sale of lots is subject to the registration requirements of the Act but the circumstances of the sale are such that no affirmative action to enforce the registration requirements is needed to protect the public interest or prospective purchasers, the Secretary may issue a No Action Letter.

(b) To obtain a No Action Letter a developer must submit a request which includes a thorough description of the proposed transaction, the property involved, and the circumstances surrounding the sale.

(c) The issuance of a No Action Letter will not affect any right which a purchaser has under the Act, and it will not limit future action by the Secretary if there is evidence to show that affirmative action is necessary to protect the public interest or prospective purchasers. In no event will a No Action Letter be issued after the sale has occurred.

[45 FR 40479, June 13, 1980]

24 CFR Ch. X (4-1-11 Edition)

§ 1710.20 Requirements for registering a subdivision—Statement of Record—filing and form.

(a) *Filing.* In order to register a subdivision and receive an effective date, the developer or owner of the subdivision must file a Statement of Record with the Secretary. The official address to be used is:

Office of Interstate Land Sales Registration,
Department of Housing and Urban Development,
451 Seventh Street, SW., Washington, DC 20410.

When the Statement of Record is filed, a fee in the amount set out in §1710.35(b) must be paid in accordance with §1710.35(a).

(b) *Form.* The Statement of Record shall be in the format specified in §1710.100 and shall be completed in accordance with the instructions in §§1710.102, 1710.105 through 1710.118, 1710.200, 1710.208 through 1710.216 and 1710.219. It shall be supported by the documents required by §§1710.208 through 1710.216 and 1710.219. It shall include any other information or documents which the Secretary may require as being necessary or appropriate for the protection of purchasers.

(c) *State filings.* A Statement of Record submitted under the provisions of 24 CFR part 1710, subpart C—Certification of Substantially Equivalent State Law, shall consist of the materials designated by the Certification Agreement between the Secretary and the certified State in which the subdivision is located.

(Pub. L. 90-448, 82 Stat. 476, 590; 15 U.S.C. 1701 *et seq.*)

[44 FR 21453, Apr. 10, 1979, as amended at 50 FR 10942, Mar. 19, 1985; 63 FR 54332, Oct. 8, 1998]

§ 1710.21 Effective dates.

(a) *General.* The effective date of an initial, consolidated or amended Statement of Record is the 30th day after the filing of the latest amendatory material unless the Secretary notifies the developer in writing prior to such 30th day that:

- (1) The effective date has been suspended in accordance with §1710.45(a), or
- (2) An earlier effective date has been determined.

(b) *Suspension of effective date by developer.* (1) A developer, or owner, may request that the effective date of its Statement of Record be suspended, provided there are no administrative proceedings pending against either of them at the time the request is submitted. The request must include any consolidations or amendments which have been made to the initial Statement of Record. Forms for this purpose will be furnished by the Secretary upon request.

(2) Upon acceptance by the Secretary, the effectiveness of the Statement of Record shall be suspended as of the date the request was executed by the developer or owner.

(3) The suspension shall continue until the developer, or owner, submits all amendments necessary to bring the registration into full compliance with the Regulations which are in effect on the date of the amendments and the Secretary allows those amendments to become effective.

(Pub. L. 90-448, 82 Stat. 476, 590; 15 U.S.C. 1701 *et seq.*)

[44 FR 21453, Apr. 10, 1979, as amended at 49 FR 31370, Aug. 6, 1984]

§ 1710.22 Statement of record—initial or consolidated.

(a) *Initial Statement of Record.* (1) Except in the case of exempt transactions, an initial Statement of Record shall be filed, and an effective date issued, prior to selling or leasing any lot in a subdivision.

(2) If a developer buys from another developer 100 or more lots from an existing registration, the new developer, or owner, may have to submit a new initial Statement of Record and receive an effective date covering the acquired lots prior to selling or leasing any of those lots.

(3) Changes in principals due to a sale of stock in a corporation or changes in partners or joint venturers which are accomplished in accordance with the partnership or joint venture agreement but which do not cause a change in the title to the land in the subdivision may be submitted as an amendment.

(4) Any initial Statement of Record must be accompanied by a fee, as specified in § 1710.35(b), based upon the number of lots sought to be registered.

(b) *Consolidated Statement of Record.*

(1) If the developer intends to sell or lease additional lots as part of the same common promotional plan with lots already registered, a consolidated Statement of Record may be submitted for the additional lots. A fee, as specified in § 1710.35(b) and based on the number of additional lots, must accompany the submission. The additional lots may not be sold or leased until a new effective date is issued.

(2) If the additional lots are simply the result of a replatting of lots previously registered and enumerated in the Property Report and do not include any additional land, the change may be made by an amendment. However, the amendment must be accompanied by a fee, as specified in § 1710.35(b), based on the number of additional lots.

(c) *Consolidated Statement of Record—Form.* A consolidated Statement of Record shall contain:

(1) Those pages of the Property Report portion and Additional Information and Documentation portion which contain changes which have occurred since the last effective submission, and

(2) A recapitulation or listing of each of the section headings, and sub-headings if necessary, of the Additional Information and Documentation portion. Each item of the listing shall contain a statement as to whether or not any change is made in the section; whether any new or additional information is being submitted and, if documentation is incorporated by cross reference, the previous submission in which that documentation may be found, and

(3) Documentation to support the additional lots (e.g., plat maps, topographic maps and general plan to reflect new lots, title information, permits for additional facilities, financial assurances of completion of additional facilities, financial statements) or updated or expanded documents in support of previous submissions, and

(4) The affirmation required by § 1710.219.

Pages having no changes and documents in previous submissions which apply equally to the additional lots may be incorporated by reference. However, the developer may, at its option, submit the entire format for an

§ 1710.23

initial filing, including copies of previously submitted documents, to expedite the examination process.

(d) *Consolidated Statement of Record amends prior Statement of Record.* A Consolidated Statement of Record shall contain all applicable information for all registered lots in the subdivision except those deleted pursuant to other provisions in these regulations. The resulting Property Report shall be used for all sales in the subdivision, except for those transactions which are exempt from the provisions of the Act or which have been granted an exempt status by the Secretary, unless the Secretary has specifically authorized the use of multiple Property Reports.

(e) *Initial Statement of Record—when prior approval to submit is required.* In those subdivisions where there is a disparity between the lots already registered and those sought to be registered because of location, terrain, proposed use of the lots or the amenities to be furnished or available, the developer may present a resume of the differences and request the Secretary's permission to file a separate initial Statement of Record for the additional lots. Upon consideration of the facts submitted, the Secretary may allow such a procedure.

(f) *Lots which have been deleted from registration.* Should the developer, for any reason, delete by amendment any registered lots from an effective Statement of Record, those lots must be re-registered by a consolidation and a new effective date issued, before they can be sold or leased. An appropriate fee must accompany the submission.

(g) *Lots sold to individual purchasers.* It is not necessary to delete from the registration those lots which have been sold to individual purchasers for their own use.

(Pub. L. 90-448, 82 Stat. 476, 590; 15 U.S.C. 1701 *et seq.*)

[44 FR 21453, Apr. 10, 1979, as amended at 45 FR 40488, June 13, 1980]

§ 1710.23 Amendment—filing and form.

(a) *Filing.* If any change occurs in any representation of material fact required to be stated in an effective Statement of Record, an amendment shall be filed. The amendment shall be filed within 15 days of the date on

24 CFR Ch. X (4-1-11 Edition)

which the developer knows, or should have known, that there has been a change in material fact.

(b) *Form.* An amendment shall incorporate by reference the prior Statement of Record except for any changes in material fact. A change in material fact shall be specifically described and supported by the same documentation which would be required for an initial submission. Any amendment shall be accompanied by:

(1) A letter from the developer giving a clear and concise description of the purpose and significance of the amendment and referring to the section and page of the Statement of Record which is being amended, and

(2) All pages of the Statement of Record, which have been amended, retyped in the required format to reflect the changes. The OILSR number of the Statement of Record shall appear at the top of each page of the material submitted.

(c) *Amendments to suspended filings.* Developers wishing to reactivate a suspended filing shall file the following:

(1) Any amendments necessary to bring the filing into compliance, submitted in accordance with paragraphs (a) and (b) of this section;

(2) An activity report in the form prescribed by § 1710.310; and

(3) An amendment fee, if required under § 1710.35(d)(2).

(Pub. L. 90-448, 82 Stat. 476, 590; 15 U.S.C. 1701 *et seq.*)

[44 FR 21453, Apr. 10, 1979, as amended at 49 FR 31373, Aug. 6, 1984]

§ 1710.29 Use of property report—misstatements, omissions or representation of HUD approval prohibited.

Nothing is these regulations shall be construed to authorize or approve the use of a property report containing any untrue statement of a material fact or omitting to state a material fact required to be stated therein. Nor shall anything in these regulations be construed to authorize or permit any representation that the Property Report

Office of Asst. Sec. for Housing, HUD

§ 1710.45

is prepared or approved by the Secretary, OILSR or the Department of Housing and Urban Development.

(Pub. L. 90-448, 82 Stat. 476, 590; 15 U.S.C. 1701 *et seq.*)

[44 FR 21453, Apr. 10, 1979]

§ 1710.35 Payment of fees.

(a) *Method of payment.* (1) Each fee must be paid by:

(i) Certified check, cashier's check, or postal money order made payable to the Treasurer of the United States, with the registration number, when known, and the name, of the subdivision on the face of the check, and mailed to an address specified by the Secretary; or

(ii) Electronic payment in a manner specified by the Secretary.

(2) Information regarding the current mailing address or electronic payment procedures is available from: HUD, Office of Interstate Land Sales/RESPA Division, Room 9156, 451 7th St., SW., Washington, DC 20410.

(b) *Fees for registration.* The fee for each initial and consolidated registration is set forth in the following schedule:

Number of lots	Fees
200 or fewer lots	\$800
201 or more lots	\$1,000

(c) *Fee for Exemption Order or Advisory Opinion.* The filing fee for an Exemption Order or an Advisory Opinion (§1710.16 or §1710.17) is \$500. This fee is not refundable.

(d) *Amendment fee.* (1) A fee of \$800 is charged when an Annual Activity Report reflects an annual ending inventory of 101 or more unsold registered lots.

(2) A fee of \$800 is charged for an amendment to reactivate a Statement of Record subsequent to its suspension, unless the developer has 100 or fewer unsold lots included in the Statement of Record.

(Pub. L. 90-448, 82 Stat. 476, 590; 15 U.S.C. 1701 *et seq.*)

[44 FR 21453, Apr. 10, 1979, as amended at 49 FR 31373, Aug. 6, 1984; 63 FR 54332, Oct. 8, 1998]

§ 1710.45 Suspensions.

(a) *Suspension notice—prior to effective date.* (1) If it appears to the Secretary that a Statement of Record or an amendment is on its face incomplete or inaccurate in any material respect, the Secretary shall so advise the developer, by issuing a suspension notice, within a reasonable time after the filing of such materials but prior to the time the materials would otherwise be effective.

(2) A suspension notice issued pursuant to this subsection shall suspend the effective date of the Statement of Record or the amendment. It shall continue in effect until 30 days, or such earlier date as the Secretary may determine, after the necessary amendments are submitted which correct all deficiencies cited in the notice.

(3) Upon receipt of a suspension notice, the developer has 15 days in which to request a hearing. If a hearing is requested, it shall be held within 20 days of the receipt of the request by the Secretary.

(b) *Suspension orders—subsequent to effective date.* (1) A notice of proceedings to suspend an effective Statement of Record may be issued to a developer if the Secretary has reasonable grounds to believe that an effective Statement of Record includes an untrue statement of a material fact, or omits a material fact required by the Act or rules and regulations, or omits a material fact which is necessary to make the statements therein not misleading. The Secretary may, after notice, and after opportunity for a hearing requested pursuant to §1720.220 within 15 days of receipt of such notice, issue an order suspending the Statement of Record. In the event that a suspension order is issued, such order shall remain in effect until the developer has amended the Statement of Record or otherwise complied with the requirements of the order. When the developer has complied with the requirements of the order, the Secretary shall so declare and thereupon the suspension order shall cease to be effective.

(2) If the Secretary undertakes an examination of a developer or its records to determine whether a suspension

§ 1710.100

order should be issued, and the developer fails to cooperate with the Secretary or obstructs, or refuses to permit the Secretary to make such examination, the Secretary may issue an order suspending the Statement of Record. Such order shall remain in effect until the developer has complied with the requirements of the order. When the developer has complied with the requirements of the order, the Secretary shall so declare and thereupon the suspension order shall cease to be effective. In accordance with the procedure described in §1720.235, a hearing may be requested.

(3) Upon receipt of an amendment to an effective Statement of Record, the Secretary may issue an order suspending the Statement of Record until the amendment becomes effective if the Secretary has reasonable grounds to believe that such action is necessary or appropriate in the public interest or for the protection of purchasers. In accordance with the procedure described in §1720.235, a hearing may be requested.

(4) Suspension orders issued pursuant to this subsection shall operate to suspend the Statement of Record as of the date the order is either served on the developer or its registered agent or is delivered by certified or registered mail to the address of the developer or its authorized agent.

(Pub. L. 90-448, 82 Stat. 476, 590; 15 U.S.C. 1701 *et seq.*)

[44 FR 21453, Apr. 10, 1979]

Subpart B—Reporting Requirements

AUTHORITY: Pub. L. 90-448, 82 Stat. 476, 590; 15 U.S.C. 1701 *et seq.*, unless otherwise noted.

SOURCE: 44 FR 21453, Apr. 10, 1979, unless otherwise noted.

§ 1710.100 Statement of Record—format.

(a) The Statement of Record consists of two portions; the Property Report portion and the Additional Information and Documentation portion.

(b) General format. The Statement of Record shall be prepared in accordance with the following format:

24 CFR Ch. X (4-1-11 Edition)

PROPERTY REPORT

Heading and Section Number

- Cover Sheet.....1710.105
- Table of Contents.....1710.106
- Risks of Buying Land, Warnings.....1710.107
- General Information.....1710.108
- Title and Land Use.....1710.109
 - (a) General Instructions
 - (b) Method of Sale
 - (c) Encumbrances, Mortgages and Liens
 - (d) Recording the Contract and Deed
 - (e) Payments
 - (f) Restrictions
 - (g) Plats, Zoning, Surveying, Permits, Environment
- Roads.....1710.110
- Utilities.....1710.111
 - (a) Water
 - (b) Sewer
 - (c) Electricity
 - (d) Telephone
 - (e) Fuel or other Energy Source
- Financial Information.....1710.112
- Local Services.....1710.113
- Recreational Facilities.....1710.114
- Subdivision Characteristics and Climate.....1710.115
 - (a) General Topography
 - (b) Water Coverage
 - (c) Drainage and Fill
 - (d) Flood Plain
 - (e) Flooding and Soil Erosion
 - (f) Nuisances
 - (g) Hazards
 - (h) Climate
 - (i) Occupancy
- Additional Information.....1710.116
 - (a) Property Owners' Association
 - (b) Taxes
 - (c) Violations and Litigation
 - (d) Resale or Exchange Program
 - (e) Unusual Situations
 - 1. Leases
 - 2. Foreign Subdivision
 - 3. Time Sharing
 - 4. Membership
 - (f) Equal Opportunity in Lot Sales
 - (g) Listing of lots
- Cost Sheet.....1710.117
- Receipt, Agent Certification and Cancellation Page.....1710.118

ADDITIONAL INFORMATION AND DOCUMENTATION

- General Information.....1710.208
- Title and Land Use.....1710.209
- Roads.....1710.210
- Utilities.....1710.211
- Financial Information.....1710.212
- Recreational Facilities.....1710.214
- Subdivision Characteristics.....1710.215
- Additional Information.....1710.216

Affirmation1710.219

(Approved by the Office of Management and Budget under control number 2502-0243)

[44 FR 21453, Apr. 10, 1979, as amended at 49 FR 31370, Aug. 6, 1984; 49 FR 33644, Aug. 24, 1984]

§ 1710.102 General instructions for completing the Statement of Record.

(a) *Paper and type.* The Statement of Record shall be on good quality, unglazed white or pastel paper. Letter size paper, approximately 8x11 inches in size, will be used for the Property Report portion and legal size paper, approximately 8½x14 inches in size, will be used for the Additional Information and Documentation portion. Side margins shall be no less than 1 inch and no greater than 1½ inches. Top and bottom margins shall be no less than 1 inch. In the preparation of the charts to be included in the Property Report, the developer may vary from the above margin requirements or print the charts lengthwise on the required size paper if such measures are necessary to make the charts readable. The Statement of Record shall be prepared in an easily readable style of elite or pica or similar type of uniform font in blue, black or blueblack ink.

(b) *Numbering and dating.* Each page of the Statement of Record as submitted to OILSR shall be numbered and shall include the date of typing or preparation in the lower right hand corner, except in the final printed version of the Property Report portion.

(c) *Signing.* The Statement of Record shall be signed by the senior executive officer of the developer or a designated agent.

(d) *Printing.* The Statement of Record and, insofar as practical, all papers and documents filed as a part thereof, shall be printed, lithographed, photocopied, typewritten or prepared by any similar process which, in the opinion of the Secretary, produces copies suitable for a permanent record. Irrespective of the process used, all copies of any such materials shall be clear and easily readable.

(e) *Headings, subheadings, captions, introductory paragraphs, warnings.* Property Report subject "headings" are those descriptive introductory words

which appear immediately after section numbers 1710.106 through 1710.116 (e.g. §1710.108 has "General Information" and §1710.111 has "Utilities"). Each such heading shall be printed in the Property Report in underlined capital letters and centered at the top of a new page. Section numbers shall not be printed in the Property Report. Property Report subheadings are those descriptive introductory words which appear in italics in the regulations at the beginning of paragraphs designated by paragraph letters (a), (b), (c) etc. An example of a subheading is "water" found immediately after the paragraph letter (a) in §1710.111. These subheadings will be printed in the Property Report only if they are relevant to the subject subdivision. If printed these subheadings shall be capitalized and shall begin at the left hand margin of the page. Property Report "captions" are those descriptive introductory words which appear in italics in the Regulations at the beginning of subparagraphs designated by numbers (1), (2), (3), etc. An example of such captions is "Sales Contract and Delivery of Deed" found immediately after the subparagraph number "(1)" in §1710.109 (b). These captions are to be printed in the Property Report only if they are applicable to the subject subdivision. If printed, these captions shall be centered on the page from the side margins, and shall have only the first letter of each word capitalized. Headings and subheadings will be used in the Property Report in accordance with the sample page appearing in §1710.102. Introductory paragraphs will follow headings if they are applicable and necessary for a readable entry into the subject matters, but note, the introductory paragraphs for "Title to the Property and Land Use" are to be used in every case as provided in §1710.109(a)(1). Subheadings and captions which do not apply to the subdivision should be omitted from the Property Report portion and answered "not applicable" in the Additional Information and Documentation portion, unless specifically required to be included elsewhere in these instructions. Warnings shall be printed substantially as they appear in the instructions in §§1710.105 through 1710.118. They shall

§ 1710.102

24 CFR Ch. X (4-1-11 Edition)

be printed in capital letters and enclosed in a box as shown on the sample page in § 1710.102. The paragraphs in the Property Report portion need not be numbered.

SAMPLE PAGE

ROADS

Here we discuss the roads that lead to the subdivision, those within the subdivision and the location of nearby communities.

ACCESS TO THE SUBDIVISION.

County road #43 leads to the subdivision. It has two lanes and the width of the wearing surface is 22 feet. It's paved with a macadam surface.

This road is maintained by Bottineau County with County funds. No improvements are planned at this time.

ACCESS WITHIN THE SUBDIVISION.

The roads within the subdivision will be located on rights of way dedicated to the public.

We are responsible for constructing the interior roads. There will be no additional cost to you for this construction.

WE HAVE NOT SET ASIDE ANY FUNDS IN AN ESCROW OR TRUST ACCOUNT OR MADE ANY OTHER FINANCIAL ARRANGEMENTS TO ASSURE COMPLETION OF THE ROADS, SO THERE IS NO ASSURANCE WE WILL BE ABLE TO COMPLETE THE ROADS.

At present, the roads are under construction and do not provide access to the lots in Units 2 and 3 during wet weather. The succeeding chart describes their present condition and estimated completion dates.

Unit	Estimated starting date (month and year)	Percentage of construction now complete	Estimated completion date (month and year)	Present surface	Final surface
1	February 1979	50	December 1979	Gravel	Asphalt.
2	August 1979	0	June 1980	Dirt	Do.
3	April 1980	0	October 1980	None	Do.

(f) *Language style.* All information given in the Property Report portion shall be stated in narrative form using plain, concise, everyday language which can be readily understood by purchasers who are unfamiliar with real estate transactions. Excessively long paragraphs should be avoided. Keep them as brief as possible. Use separate paragraphs for different points discussed. Disclose all pertinent facts. Potential consequences to a purchaser must be made clear even though not specifically asked for in the format and the instructions. In the Property Report the pronouns "you" and "your" shall generally be used in referring to the prospective purchaser and the pronouns "we", "us", and "our" shall generally be used in referring to the developer. The Secretary specifically reserves the right to require modification of the text when the narrative does not meet the standards of this section.

(g) *Format of the Additional Information and Documentation portion of the Statement of Record.* The supporting information and documentation required by these regulations shall be identified by affixing a tab on the right side of the cover sheet of the required information or documentation and by identifying on the tab the section number of the Statement of Record instructions to which the information or documentation corresponds. This information or documentation shall then be placed immediately after the page(s) on which the section number and answers for that section appear. If the data in a document is applicable to more than one section of instructions, the developer may substitute as a document in the second case a statement incorporating the earlier document by

reference. Deeds, title policies, subdivision plats or maps and other documentary information required to be contained in the Additional Information and Documentation portion of the Statement of Record need not be on the same size paper as the Statement of Record but, if larger, shall be folded to a size no larger than 8½×14 inches. Supporting documents shall be inserted into the binding in such a manner as to permit them to be examined without the necessity of removing them from the binding. This may be accomplished by proper folding or through the use of envelopes.

(h) *Binding.* The Statement of Record shall be bound with the Property Report portion on top, including any documents which may be required to be attached when delivered to the purchaser, followed by the Additional Information and Documentation portion.

(i) *Advertising and promotional material.* No advertising, or promotional material or statements which are self-serving on behalf of the developer or owner may be included in the Statement of Record or resulting Property Report.

(j) *Additional information.* (1) In addition to the information expressly required to be stated in the Statement of Record, there shall be added, and the Secretary may require, such further material information, documentation and certification as may be necessary in the public interest and for the protection of purchasers or necessary in order to make the statements not misleading in the light of circumstances under which they are made.

(2) The instructions are not all inclusive. The developer shall include any other facts which would have a bearing upon the use by the purchaser of any of the facilities, services or amenities; which would cause or result in additional expenses to the purchaser; which would have an effect upon the use and enjoyment of the lot by the purchaser for the purpose for which it is sold or which would adversely affect the value of the lot.

(k) *Modification of format or content.* The Secretary may require or permit modification to the content and format of the Property Report to include additional information, to modify or omit

required information, or to change the sequence or position of information when such changes are deemed to be in the public interest or for the protection of purchasers.

(l) *Required documentation.* Where the documentation required by the Statement of Record cannot be obtained, the Secretary may permit the best available alternative documentation to be substituted.

(m) *Final version of property report.* On the date that a Statement of Record becomes effective, the Property Report portion shall become the Property Report for the subject subdivision. The version of the Property Report delivered to prospective lot purchasers shall be verbatim to that found effective by the Secretary and shall have no covers, pictures, emblems, logograms or identifying insignia other than as required by these regulations. It shall meet the same standards as to grade of paper, type size, margins, style and color of print as those set herein for the Statement of Record, except where required otherwise by these regulations. However, the date of typing or preparation of the pages and the OILSR number shall not appear in the final version. If the final version of the Property Report is commercially printed, or photocopied by a process which results in a commercial printing quality, and is bound on the left side, both sides of the pages may be used for printed material. If it is typed or photocopied by a process which does not result in a clear and legible product on both sides of the page or is bound at the top, printing shall be done on only one side of the page. Three copies of the final version of the Property Report, in the exact form in which it is delivered to prospective lot purchasers, shall be sent to this Office within 20 days of the date on which the Statement of Record, amendment, or consolidation is allowed to become effective by the Secretary. If a Property Report in a foreign language is used as required by §1715.25(g), three copies of that Property Report together with copies of the translated documents shall be furnished the Secretary within 20 days of the date on which the advertising is first used. A Property Report prepared pursuant to these regulations shall not

§ 1710.103

24 CFR Ch. X (4-1-11 Edition)

be distributed to potential lot purchasers until after the Statement of Record of which it is a part or any amendment to that Statement of Record has been made effective by the Secretary.

(Approved by the Office of Management and Budget under control number 2502-0243)

[44 FR 21453, Apr. 10, 1979, as amended at 45 FR 40488, June 13, 1980; 49 FR 31370, Aug. 6, 1984; 49 FR 33644, Aug. 24, 1984]

§ 1710.103 Developer obligated improvements.

(a) If the developer represents either orally or in writing that it will provide or complete roads or facilities for water, sewer, gas, electricity or recreational amenities, it must be contractually obligated to do so (see §1715.15(f)), and the obligation shall be clearly stated in the Property Report. While the developer may disclose relevant facts about completion, the obligation to complete cannot be conditioned, other than as provided for in §1715.15(f), and an estimated completion date (month and year) must be stated in the Property Report. However, a developer that has only tentative plans to complete may so state in the Property Report, provided that the statement clearly identifies conditions to which the completion of the facilities are subject and states that there are no guarantees the facilities will be completed.

(b) If a party other than the developer is responsible for providing or completing roads or facilities for water, sewer, gas, electricity or recreational amenities, that entity shall be clearly identified in the Property Report under the categories described in §1710.110, §1710.111 or §1710.114, as applicable. A statement shall be included in the proper section of the Property Report that the developer is not responsible for providing or completing the facility or amenity and can give no assurance that it will be completed or available for use.

[49 FR 31370, Aug. 6, 1984]

§ 1710.105 Cover page.

The cover page of the Property Report shall be prepared in accordance with the following directions:

(a) The margins shall be at least 1 inch.

(b) The next 3 inches shall contain a warning, centered, in 1/2 inch capital letters in red type with 1/4 inch space between the lines which reads as follows:

READ THIS PROPERTY REPORT BEFORE SIGNING ANYTHING

(c) The remainder of the page shall contain the following paragraphs beginning 1/4 inch below the last line of the warning:

This Report is prepared and issued by the developer of this subdivision. It is *not* prepared or issued by the Federal Government.

Federal law requires that you receive this Report prior to your signing a contract or agreement to buy or lease a lot in this subdivision. However, NO FEDERAL AGENCY HAS JUDGED THE MERITS OR VALUE, IF ANY, OF THIS PROPERTY.

If you received this Report prior to signing a contract or agreement, you may cancel your contract or agreement by giving notice to the seller any time before midnight of the seventh day following the signing of the contract or agreement.

If you did not receive this Report before you signed a contract or agreement, you may cancel the contract or agreement any time within two years from the date of signing.

Name of Subdivision _____
Name of Developer _____
Date of This Report _____

(d)(1) If the purchaser is entitled to a longer revocation period by operation of State law, that period becomes the Federal revocation period and the Cover Page must reflect the requirements of the longer period, rather than the seven days.

(2)(i) If a deed is not delivered within 180 days of the signing of the contract or agreement of sale or unless certain provisions are included in the contract or agreement, the purchaser is entitled to cancel the contract within two years from the date of signing the contract or agreement.

(ii) The deed must be a warranty deed, or where such a deed is not commonly used, a similar deed legally acceptable in the jurisdiction where the lot is located. The deed must be free and clear of liens and encumbrances.

(iii) The contract provisions are:

(A) A legally sufficient and recordable lot description; and

(B) A provision that the seller will give the purchaser written notification of purchaser's default or breach of contract and the opportunity to have at least 20 days from the receipt of notice to correct the default or breach; and

(C) A provision that, if the purchaser loses rights and interest in the lot because of the purchaser's default or breach of contract after 15% of the purchase price, exclusive of interest, has been paid, the seller shall refund to the purchaser any amount which remains from the payments made after subtracting 15% of the purchase price, exclusive of interest, or the amount of the seller's actual damages, whichever is the greater.

(iv) If a deed is not delivered within 180 days of the signing of the contract or if the necessary provisions are not included in the contract, the following statement shall be used in place of any other recision language:

Under Federal law you may cancel your contract or agreement of sale any time within two years from the date of signing.

(e) At the time of submission, the developer may indicate its intention to comply with the red printing by an illustration or by a statement to that effect.

(f) The "Date of This Report" shall be the date on which the Secretary allows the Statement of Record to become effective and shall not be entered until the submission has become effective.

(Sec. 1419, Interstate Land Sales Full Disclosure Act, 82 Stat. 590, 598; 15 U.S.C. 1718; sec. 7(d), Dept. of Housing and Urban Development Act, 42 U.S.C. 3535(d))

[45 FR 40489, June 13, 1980]

§ 1710.106 Table of contents.

(a) The second page(s) shall consist of a Table of Contents which lists the headings in the Property Report, the major subheadings, if any, and the page on which they appear. For example, the entry for Title and Land Use would appear as follows:

Title and Land Use # Page #
Method of Sale
Encumbrances, Mortgages and Liens
Recording the Contract and Deed

Payments

Restrictions on the Use of Your Lot
Plat Maps, Zoning, Surveying, Permits and Environment

(b) Use of "You" and "We". At the end of the Table of Contents insert the following remark:

"In this Property Report, the words "you" and "your" refer to the buyer. The words "we", "us" and "our" refer to the developer."

§ 1710.107 Risks of buying land.

(a) The next page shall be headed "Risks of Buying Land" and shall contain the paragraphs listed below. However, paragraph (a)(2) of this section may be omitted if all improvements have been completed or if no improvements are proposed.

(1) The future value of any land is uncertain and dependent upon many factors. DO NOT expect all land to increase in value.

(2) Any value which your lot may have will be affected if the roads, utilities and all proposed improvements are not completed.

(3) Resale of your lot may be difficult or impossible, since you may face the competition of our own sales program and local real estate brokers may not be interested in listing your lot.

(4) Any subdivision will have an impact on the surrounding environment. Whether or not the impact is adverse and the degree of impact, will depend on the location, size, planning and extent of development. Subdivisions which adversely affect the environment may cause governmental agencies to impose restrictions on the use of the land. Changes in plant and animal life, air and water quality and noise levels may affect your use and enjoyment of your lot and your ability to sell it.

(5) In the purchase of real estate, many technical requirements must be met to assure that you receive proper title. Since this purchase involves a major expenditure of money, it is recommended that you seek professional advice before you obligate yourself.

(b) Warnings. If the instructions or the Secretary require any warnings to be included in the Property Report portion, the following statement shall be

§ 1710.108

added beneath the “Risks of Buying Land” under a heading “Warnings”:

“Throughout this Property Report there are specific warnings concerning the developer, the subdivision or individual lots. Be sure to read all warnings carefully before signing any contract or agreement.”

Both the heading, “Warnings”, and the statement shall be printed in capital letters and enclosed in a box.

§ 1710.108 General information.

Insert and complete the following format:

“This Report covers ___ lots located in _____ County, (State). See Page ___ for a listing of these lots. It is estimated that this subdivision will eventually contain _____ lots.”

“The developer of this subdivision is:

(Developer’s Name)

(Developer’s Address)

(Developer’s telephone number)

“Answers to questions and information about this subdivision may be obtained by telephoning the developer at the number listed above.”

§ 1710.109 Title to the property and land use.

(a) General instructions. (1) Below the heading “Title to the Property and Land Use” insert the following introductory paragraphs:

“A person with legal title to property generally has the right to own, use and enjoy the property. A contract to buy a lot may give you possession but doesn’t give you legal title. You won’t have legal title until you receive a valid deed. A restriction or an encumbrance on your lot, or on the subdivision, could adversely affect your title.”

“Here we will discuss the sales contract you will sign and the deed you will receive. We will also provide you with information about any land use restrictions and encumbrances, mortgages, or liens affecting your lot and some important facts about payments, recording, and title insurance.”

(2) Information to be provided. After the above introductory paragraphs provide the information required by the following instructions and questions. Follow a general form identical to the sample page printed in §1710.102.

(b) Method of sale—(1) Sales contract and delivery of deed. (i) Will the buyer

sign a purchase money or installment contract or similar instrument in connection with the purchase of the lot? When will a deed be delivered?

(ii) If an installment contract is used, include the following, or substantially the same, language in the disclosure narrative under “Method of Sale”:

“If you fail to make your payments required by the contract, you may lose your lot and all monies paid.”

(iii) If, at the time of a credit sale, the developer gives the buyer a deed to the lot, what type of security must the buyer give the seller?

(iv) If the lots are to be sold on the basis of an installment contract, can the developer or the owner of the subdivision or their creditors encumber the lots under contract? If so, include the following warning in the disclosure narrative under the caption “Sales contract and delivery of deed”:

“The (indicate subdivision developer, owner, or their creditors) can place a mortgage on or encumber the lots in this subdivision after they are under contract. This may cause you to lose your lot and any monies paid on it.”

(2) Type of deed. What type of deed will be used to convey title to lots in the subdivision?

(3) Quitclaim deeds. If a quitclaim deed is to be given to lot purchasers insert the below warning, or a warning which is substantially the same, in the disclosure narrative below the caption “Quitclaim Deeds”. This particular warning may be deleted at the direction of the Secretary if an acceptable attorney’s opinion is submitted with the Statement of Record which indicates that a quitclaim deed has a meaning in the jurisdiction where the subdivision is located which is substantially contrary to the effect of this warning. This warning shall be phrased substantially as follows:

“The Quitclaim deed used to transfer title to lots in this subdivision gives you no assurance of ownership of your lot.”

(4) Oil, gas, and mineral rights. If oil, gas or mineral rights have been reserved, insert the following statement or one substantially the same in the narrative answer under the caption “oil, gas, and mineral rights”:

“The (indicate oil, gas, or mineral rights) to (state which lots) in this subdivision will not belong to the purchaser of those lots. The exercise of these rights could affect the use, enjoyment and value of your lot.”

(c) *Encumbrances, mortgages and liens*—(1) *In general.* State whether any of the lots or common facilities which serve the subdivision, other than recreation facilities, are subject to a blanket encumbrance, mortgage or lien. If yes, identify the type of encumbrance (e.g. deed of trust, mortgage, mechanics liens), the holder of the lien, and the lots covered by the lien. If any blanket encumbrance, mortgage, or lien is not current in accordance with its terms, so indicate.

(2) *Release provisions.* (i) Explain the effect of any release provisions of any blanket encumbrance, mortgage or lien and include the one of the following statements that pertains.

(A) If the release clauses are not included in a recorded instrument, insert the following statement or one substantially the same in the disclosure narrative below the caption “Release Provisions”:

“The release provisions for the (indicate all or particular lots) have not been recorded. Therefore, they may not be honored by subsequent holders of the mortgage. If they are not honored, you may not be able to obtain clear title to a lot covered by this mortgage until we have paid the mortgage in full, even if you have paid the full purchase price of the lot. If we should default on the mortgage prior to obtaining a release of your lot, you may lose your lot and all monies paid.”

(B) If the developer or subdivision owner states that the release provisions are recorded and that the lot purchaser may pay the release price of the mortgage, the statement shall be supported by documentation supplied in §1710.209. If the purchaser may pay the release fee, state the amount of the release fee and inform the purchaser that the amount may be in addition to the contract payments unless there is a bona fide trust or escrow arrangement in which the purchaser’s payments are set aside to pay the release price before any payments are made to the developer.

(C)(1) If there are no provisions in the blanket encumbrance for release of an individual purchaser’s lot from a blan-

ket encumbrance, include the following warning or a warning substantially the same, in the disclosure narrative under the “Release Provisions” caption:

“The (state type of encumbrance) on (indicate all or particular lots) in this subdivision does not contain any provisions for the release of an individual lot when the full purchase price of the lot has been paid. Therefore, if your lot is subject to this (state type of encumbrance), you may not be able to obtain clear title to your lot until we have paid the (state type of encumbrance) in full, even though you may have received a deed and paid the full purchase price of the lot. If we should default on the (state type of encumbrance) prior to obtaining a release, you may lose your lot and all monies paid.”

(2) If the provisions for release of individual lots from the blanket encumbrance may be exercised only by the developer insert the following statement, or one substantially the same, in the disclosure narrative under the “Release Provisions” caption:

“The release provisions in the (state the type of encumbrance) on (indicate all or particular lots) in this subdivision may be exercised only by us. Therefore, if we default on the (state type of encumbrance) before obtaining a release of your lot, you may lose your lot and any money you have paid for it.”

(d) *Recording the contract and deed*—(1) *Method or purpose of recording.* (i) State what protection, if any, recording of deeds and contracts gives a lot purchaser in your jurisdiction.

(ii) If the sales contract or deed may be recorded, so state. Also state whose responsibility it is to record the contract or deed.

(iii) If the developer or subdivision owner will not have the sales contract officially acknowledged or if the applicable jurisdiction will not record sales contracts, state that sales contracts will not be recorded and why they will not be recorded.

(iv) If at, or immediately after, the signing of a contract, the contract or a deed transfer to the buyer is not recorded by the developer or owner or if title to the lot is not otherwise transferred of record to a trust, or if other sufficient notice of transfer or sale is not placed of record, then the developer

shall include the following, or substantially the same, warning in the disclosure narrative under the caption “Method and Purpose of Recording”:

“Unless your contract or deed is recorded you may lose your lot through the claims of subsequent purchasers or subsequent creditors of anyone having an interest in the land”.

The reference to contracts shall be deleted from the above warning if the answer to paragraph (d)(1)(i) of this section indicates that recording of a contract in the subject jurisdiction does not protect the purchaser from claims of later purchasers or creditors of anyone having an interest in the land.

(2) *Title insurance.* If the developer does not deliver a title insurance policy to the buyer, state that the purchaser should obtain an attorney’s opinion of title or a title insurance policy which will describe the rights of ownership which are being acquired in the lot. Recommend that an appropriate professional should interpret the opinion or policy.

(e) *Payments—(1) Escrow.* If purchasers’ deposits, down payments, or installment payments are to be placed in a third party controlled escrow or similar account, describe the arrangement including the name and address of the escrow holder or similar person. If there is no such arrangement, insert the following statement in the disclosure narrative under the caption “Escrow”:

“You may lose your (indicate deposit, down payment and/or installment payments) on your lot if we fail to deliver legal title to you as called for in the contract, because (they are/it is) not held in an escrow account which fully protects you.”

The questions regarding an escrow agreement or similar protection may be answered affirmatively only if the money is under the control of an independent third party, allowing a purchaser to receive a return of all money paid in the event of the developer’s failure to convey title or the developer’s default on any obligation which would otherwise result in the purchaser’s loss of that money.

(2) *Prepayments.* Explain any prepayment penalties or privileges in everyday language.

(3) *Default.* What are the developer’s or subdivision owners’ remedies against a defaulted purchaser?

(f) *Restrictions on the use of your lot—(1) Restrictive covenants.* (i) Have any restrictive covenants been recorded against the land in the subdivision? If so, do they contain items which require the purchaser to secure permissions, approvals or take any other action prior to using or disposing of his lot (e.g., architectural control, developer’s right of first refusal, building deadlines, etc.)? If any of these or similar items are included, explain their meaning and effect upon the purchaser.

(ii) If any restrictive covenants are to be used and if they have not been recorded, how will they be imposed? Include a statement to the effect that the restrictive covenants have not been recorded; that there is no assurance they will be applied uniformly; that they may be changed and that they may be difficult to enforce. If no restrictive covenants will be imposed, include a statement to the effect that, since there are no restrictive covenants on the use of the lots, they may be used for purposes which could adversely affect the use and enjoyment of surrounding lots.

(iii) If there are restrictive covenants, whether recorded or unrecorded, the following statement shall be made: “A complete copy of these restrictions is available upon request.”

(2) *Easements.* (i) Are there easements which may have an effect on the purchaser’s building or lot use plans (e.g., large drainage easements along lot lines, high voltage electric transmission lines, pipe lines or drainage easements which encroach upon the building area of the lot or inhibit its use)?

(ii) Is the subdivision subject to any type of flood control or flowage easements?

(iii) If the answer to either (2)(i) or (2)(ii) is in the affirmative, identify the affected lots and state the effect upon the use of the lots.

(g) *Plats, zoning, surveying, permits and environment—(1) Plats.* (i) Have the subdivision plans and plats of specific units been approved by the regulatory authorities? If the approvals have not been obtained, include a warning to the

effect that regulatory authorities have not approved the proposed plats; that they may require significant alterations before they will approve them and they may not allow the land to be used for the purpose for which it is being sold.

(ii) Have plats covering the lots in this Report been recorded? If so, where are they recorded? If they have not been recorded, is the description of the lots given in this Report legally adequate for the conveyance of land in the jurisdiction where the subdivision is located? If it is not, include a statement to the effect that the description of the lots is not legally adequate for the conveyance of the lots and that it will not be until the plat is recorded.

(2) *Zoning.* For what purpose may the lots be used (e.g., single family homes, camping, commercial)? Does this use conform to local zoning requirements and the restrictive covenants?

(3) *Surveying.* Has each lot been surveyed and is each lot marked for identification? If not, and the purchaser is responsible for the expense, state the estimated cost.

(4) *Permits.* Must the purchaser obtain a building permit before beginning construction on his lot? Where is the permit obtained? Are any other permits necessary to use the lot for the purpose for which it is sold or for construction in connection with its use?

(5) *Environment.* Has there been any environmental impact study prepared which considers the effect of the subdivision on the environment? If a study has been prepared, summarize any adverse conclusions and refer the lot buyer to the proper State Clearinghouse for complete information. If a study has not been prepared, include a statement that "No determination has been made as to the possible adverse effects the subdivision may have upon the environment and surrounding area."

(If the developer does not know whether an environmental impact study has

been prepared, or the name and location of the Office where any study made can be found, inquiry should be made to the State or Area Clearinghouse established under the authority of title IV of the Intergovernmental Cooperation Act of 1968.)

§ 1710.110 Roads.

(a) *Access to the subdivision.* (1) Is access to the subdivision provided by public or private roads? What type of surface do they have? How many lanes? What is the width of the wearing surface?

(2) Who is responsible for their maintenance? What is the cost to the purchaser, if any? Are any improvements contemplated? If so, when will they begin and when will they be completed? At whose expense?

(b) *Access within the subdivision.* (1) How have legal and physical access by conventional automobile been or will they be, provided to the lots (e.g., road on recorded easement; right of way dedicated to the public; right of way dedicated to use of lot owners)?

(2) Who is responsible for the road construction? Is there any construction cost to the purchaser? Is there any financial assurance of completion? If there is no financial assurance of completion, enter a warning to the effect that no funds have been set aside in an escrow or trust account and there are no other financial arrangements to assure completion of the roads.

(3) How many lanes do the interior roads have? What is the estimated starting date of construction (month and year); the present percentage of construction now complete; the present surface; the estimated completion date (month and year) and what is the final surface to be? If there are separate units or sections in the subdivision which will have different completion dates or different surfaces, the following chart shall be used rather than a narrative paragraph.

Unit	Estimated starting date (month/year)	Percentage of construction now complete	Estimated completion date (month/year)	Present surface	Final surface

§ 1710.111

24 CFR Ch. X (4-1-11 Edition)

(4) Who is responsible for road maintenance? If the roads are to be maintained by a public authority, a property owners' association or some other entity at some time in the future, who is responsible for their maintenance during the interim period? What is the cost to the purchaser during the interim period and after acceptance for permanent maintenance? Will they be maintained so as to provide access to the lots on a year round basis? If not, include a warning which informs the purchaser that access may not be available year round. Identify the months when access may not be available to lots. If there are no arrangements for maintenance, include a warning to the effect that purchasers are responsible for maintaining the roads and that, if maintenance is not performed, the roads may soon deteriorate and access may become difficult or impossible.

(5) If estimated completion dates given in prior Statements of Record have not been met, state that previous dates have not been met and give the previous dates. Underline the answer. If the roads are 100 percent completed, no dates are needed.

(6) Complete the following chart by listing the county seat (identify) and at least two nearby communities.

Include at least one community of significant size which offers general services.

Nearby Communities.....
Population
Distance Over Paved Roads.....
Distance Over Unpaved Roads.....
Total

(7) If the purchasers will be individually responsible for providing access to their lots and for maintaining that access, what is the estimated cost of construction and maintenance?

§ 1710.111 Utilities.

(a) Water. (1) How is water to be supplied to the individual lots (e.g., central system or individual wells)? Of the following items only those which apply to the subdivision need be included.

(i) Individual system. (A) If water is to be supplied by an individual private well, cistern or other individual system, what are the total estimated costs of the system, including but not lim-

ited to, the costs of installation, storage, any treatment facilities and other necessary equipment?

(B) If individual cisterns or similar storage tanks are to be used, state where water to fill them can be secured; the cost of the water, and its delivery costs for a supply sufficient to serve the monthly needs of a family of four living in a house on a year-round basis. Include a statement to the effect that water stored for extended periods tends to become stale and may acquire an unpleasant taste or odor.

(C) If individual wells are to be used and if the sales contract contains no provisions for refund or exchange in the event a productive well cannot be installed, include a statement to the effect that there is no assurance a productive well can be installed and, if it cannot, no refund of the purchase price of the lot will be made.

(D) If individual wells or individual cisterns are to be used, include a brief statement to the effect that the purity and chemical content of the water cannot be determined until each individual well or source of water is completed and tested.

(E) If there have been no hydrological surveys in connection with the use of individual wells or sources of hauled water for cisterns, include a warning to the effect that there is no assurance of a sufficient supply of water for the anticipated population.

(F) Is a permit required to install the individual system to be used? If so, from whom and where is the permit secured? State the cost of a permit.

(ii) Central system. (A) If water is to be provided by a central system, who is the supplier? What is the supplier's address?

(B) Will the water mains be extended in front of, or adjacent to, each lot? When will construction begin? What is the present percentage of completion of the water mains and central supply plant? When will service be available to the individual lots? If the central system is not complete and there are separate units or sections of the subdivision included in the Statement of Record which have different completion dates, then the starting date for construction (month and year), the

percentage of construction now complete and the estimated service availability date (month and year) shall be set forth in the following chart form rather than in a narrative paragraph.

WATER

Unit	Estimated starting date (month and year)	Percentage of construction now complete	Estimated service availability date (month and year)

(C) What is the present capacity of the central plant (i.e., how many connections can be supplied)? If the capacity is not sufficient to serve all lots in the Statement of Record and is to be expanded in phases, what is the timetable for each phase to be in service and what will trigger the beginning of the expansion for each phase? If an entity other than the developer or an affiliate or subsidiary of the developer will supply the water for the central system; if the operation of that entity is supervised by a governmental agency and if that entity states it can supply the anticipated population of the development, then information as to the capacity of the plant and a hydrological survey is not necessary. If the entity does not indicate it can supply enough water for the anticipated population or if the capacity of any central system is not sufficient to serve all lots in the Statement of Record, include a warning which describes the limitations and sets forth the number of lots which can now be served.

(D) Have there been any hydrological surveys to determine that a sufficient source of water is available to serve the anticipated population of the subdivision? Has the water in the central system been tested for purity and chemical content? If so, did the results show that the water meets all standards for a public water supply? If there have been no hydrological surveys showing a sufficient supply of water or no tests for purity and chemical content for the central system, include a warning to the effect that there is no assurance of a sufficient supply or that the water is drinkable.

(E) Is there any financial assurance of completion of the central system and any future expansion? If not, include a warning to the effect that no funds have been set aside in an escrow or trust account nor have any other financial arrangements been made to assure completion of the water system.

(F) If the developer or an affiliate or subsidiary of the developer operates the central system, have all permits been obtained from the proper agencies for the construction, use and operation of the central system? If not, include a warning to the effect that the required permits, approvals or licenses for construction, operation or use of the water system have not been obtained, therefore there is no assurance the system can be constructed or used.

(G) If previous completion dates given in prior Statements of Record have not been met, state that previous completion dates have not been met and give the previous dates. Underline the answer. If the central water system is 100 percent completed, no dates are needed.

(H) Is the purchaser to pay any construction costs, one-time connection fees, availability fees, special assessments or deposits for the central system? If so, what are the amounts? If not, state there are no charges other than use fees. If the purchaser will be responsible for construction costs of the water mains, state the cost to install the mains to the most remote lot covered by this report.

(I) If a purchaser wishes to use a lot prior to the date central water is available to it, may the purchaser install an individual system? If so, include the information required for individual systems in §1710.111(a)(1)(i). Will the purchaser be required to discontinue use of any individual system and connect to the central system when service is available to the lot? If the purchaser is not required to connect to the central system, must any construction costs, connection fees, availability fees, special assessments or deposits in connection with the central system still be paid? If an individual system may not be installed, so state and indicate water will not be available until the central system is extended to the lot.

(J) If connection to the system is voluntary and not all purchasers elect to use the system, will the cost to those who do use the system be increased? If so, include a statement to the effect that connection to the central system is voluntary and those who use the system may have to pay a disproportionate share of the cost of the system and its operation.

(K) If the developer is to construct the system and will later turn it over to a property owners' association for operation and maintenance, state the estimated date and conditions of the conveyance and if it will be conveyed free and clear of any encumbrance. If there is a charge or if the association must assume an encumbrance, state the estimated amount of either and the terms for retirement of either obligation.

(L) If the supplier of water is other than a governmental agency or an entity which is regulated and supervised by a governmental agency, state that neither the operation of the water system nor the rates are regulated by a public authority.

(M) The following warning shall be included unless:

(1) The central water system is owned and operated by the developer, or an affiliate or subsidiary of the developer, or

(2) The central water system is owned and operated by a governmental agency or by an entity which is regulated and supervised by a governmental agency.

"We do not own or operate the central water system so we cannot assure its continued availability for your use."

(b) *Sewer.* (1) What methods of sewage disposal are to be used (e.g., central system, comfort stations or individual on-site systems such as septic tanks, holding tanks, etc.) in the subdivision? Of the following items, only those which apply to the subdivision need be included.

(i) *Individual systems.* (A) If individual systems are to be used, have the local authorities given general approval to the use of these systems in the subdivision or have they given specific approval for each lot?

Are permits necessary? From whom and where are they obtained? Must testing of the lot be done prior to the issuance of a permit? State the cost of a permit and the estimated costs of the system and any necessary tests.

(B) If holding tanks are to be used, state whether pumping and hauling service is available and the estimated monthly costs of that service for a family of four living in a house on a year-round basis.

(C) If each and every lot has not been approved for the use of an individual on-site system, include a warning to the effect that there is no assurance permits can be obtained for the installation and use of individual on-site systems. If the sales contract contains no provisions for refund or exchange in the event a permit cannot be obtained, include a statement to the effect that there is no assurance an individual on-site system can be installed and, if it cannot, no refund of the purchase price of the lot will be made.

(D) If no permit is required for the installation and use of individual on-site systems, explain whether this may have an effect upon the purchaser or the availability of construction or permanent financing.

(E) If the developer has knowledge that permits for the installation of individual on-site systems have been denied; that there have been unsatisfactory percolation tests or that systems have not operated satisfactorily in the subdivision, state the number of these rejections, unsatisfactory tests or operations.

(ii) *Comfort stations.* (A) If comfort stations are to be used, how many lots will be served by each station? When will construction be started? When will the station or stations be completed and ready for use? Have the necessary permits been obtained for the construction and use of comfort stations? If the necessary permits have not been obtained, include a warning that the necessary permits, approvals or licenses have not been obtained for the construction and use of the comfort stations, therefore there is no assurance they can be constructed or used. If there are comfort stations located in different units and having different completion dates, the following chart

shall be used to show the estimated construction starting date (month and year), the present percentage of completion and the date on which they will be used rather than a narrative paragraph.

COMFORT STATIONS

Unit _____
 Estimated Starting Date (month-year) _____
 Percentage of Construction now complete _____
 Estimated Service Availability Date (month and year) _____

(B) Who is to construct the comfort stations? Is there any financial assurance of their completion? If not, include a warning to the effect that no funds have been set aside in an escrow or trust account nor have any other financial arrangements been made to assure completion of the comfort stations and there is no assurance the facilities will be completed.

(C) Who will be responsible for maintenance of the comfort stations? Is there any cost to the purchaser for construction, use or maintenance?

(iii) *Central system.* (A) If a central sewage treatment and collection system is being installed, who is responsible for construction of the system? Will the sewer mains be installed in front of, or adjacent to, each lot? When will construction be started (month and year)? When will service be available (month and year)? Who will own and operate the system? Give the name and address of the entity.

(B) What is the present percentage of completion and the present capacity of the system (i.e., number of connections which can be served)? If the present capacity is not sufficient to serve all lots in the Statement of Record and it is to be expanded in phases, what is the time-table for expansion and what will trigger that expansion? If the central system is not complete and there are separate units or sections of the subdivision which have different service availability dates, the following chart shall be used to show the construction starting date (month and year); the percentage of completion and service availability date (month and year) in each unit or section rather than a narrative paragraph.

SEWER

Unit Estimated Starting Date (month/year) _____
 Percentage of Construction now complete _____
 Estimated Service Availability Date (month/year) _____

If sewage treatment facilities are to be supplied by an entity which is regulated by a governmental agency and which is not the developer or an affiliate or subsidiary of the developer and the entity has stated it can serve the anticipated population of the development, then information on capacity need not appear.

(C) If the developer or an affiliate or subsidiary of the developer operates the central system, have all necessary permits been obtained for the construction, operation and use of the central system? Do these permits limit the number of connections or homes which the system may serve? If the permits have not been obtained, enter a warning to the effect that the necessary permits, approvals or licenses have not been obtained for the central sewage system; therefore there is no assurance that the system can be completed, operated or used.

(D) If the system cannot now serve all lots included in the Statement of Record, either because the supplier of the service has not stated it can and will serve all lots or if construction has not reached a stage where all lots can be served or permits to serve all lots have not been obtained, include a warning which states that all lots cannot now be served; the number which can be served and the reason for the lack of capacity.

(E) Will the purchaser pay any construction costs, special assessments, one time connection fees or availability fees? What are the amounts of these charges? If the purchaser is to pay construction costs of the sewer mains, state the cost of installation of the mains to the most remote lot in this Report.

(F) If the purchaser wishes to use the lot prior to the date central sewer service is available, may the purchaser install an individual system? If so, include the information on individual systems required by § 1710.111(b)(1)(i). Will the purchaser be required to discontinue use of the individual system and connect to the central system

§ 1710.111

24 CFR Ch. X (4-1-11 Edition)

when service is available? If the purchaser is not required to connect to the central system, must the purchaser still pay any construction costs, connection fees, availability fees, or special assessments? If the purchaser may not install an individual system, so state and indicate service will not be available until the central system reaches the lot.

(G) If connection to the system is voluntary and not all purchasers elect to use the system, will the cost to those who do use the system be increased? If so, include a statement to the effect that connection to the central system is voluntary and those who use the system may have to pay a disproportionate share of the cost of the system and its operation.

(H) Is there any financial assurance of completion of the central system and any future expansion? If not, include a warning that no funds have been set aside in an escrow or trust account nor have any other financial arrangements been made to assure the completion of the central system; therefore there is no assurance that it will be completed.

(I) If previous completion dates given in prior Statements of Record have not been met, state that previous dates have not been met and give the previous dates. Underline the answer. If the central sewage treatment and collection system are 100 percent completed, no dates are needed.

(J) If the developer is to construct the system and will later turn it over to a property owners' association for operation and maintenance, state the date of the transfer and whether there will be any charge for the conveyance and if it will be conveyed free and clear of any encumbrance. If there is a charge or if the association must assume an encumbrance, state the estimated amount of either and the terms for retirement of either obligation.

(K) If the owner or operator of the central sewer system is other than a governmental agency or an entity which is regulated and supervised by a governmental agency, state that neither the operation of the sewer system nor the rates are regulated by a public authority.

(L) The following warning shall be included unless:

(1) The central sewer system is owned and operated by the developer, or an affiliate or subsidiary of the developer, or

(2) The central sewer system is owned and operated by a governmental agency or by an entity which is regulated and supervised by a governmental agency.

"We do not own or operate the central sewer system so we cannot assure its continued availability for your use."

(c) *Electricity.* (1) Who will provide electrical services to the subdivision?

(2) Have primary electrical service lines been extended in front of, or adjacent to, all of the lots? If not, when (month and year) or under what conditions will construction begin and when will service be available? If they have not been installed, who is responsible for their construction?

If electrical service lines have not been extended in front of, or adjacent to, all lots and there are separate units or sections having different service availability dates, the following chart shall be used rather than a narrative paragraph.

ELECTRIC SERVICE

Unit	Estimated starting date (month and year)	Percentage of construction complete	Estimated service availability date (month and year)

(3) If construction of the lines or service to the ultimate consumer is provided by an entity other than a publicly regulated utility, who provides, or will provide, the service? Who will be responsible for maintenance? What is the assurance of completion? If service is not provided by a publicly regulated utility, what charges or assessments will the purchaser pay?

(4) If the primary service lines have not been extended in front of, or adjacent to each lot, will the purchaser be responsible for any construction costs? If so, what is the utility company's policy and charges for extension of primary lines? Based on that policy, what would be the cost to the purchaser for

extending primary service to the most remote lot in this Report?

(5) If electrical service will not be provided, what is an alternate source (e.g., generators, etc.) and what are the estimated costs?

(6) If the lines are to be installed by some entity other than a publicly regulated utility and if there is no financial assurance of completion, include a warning to the effect that no funds have been set aside in an escrow or trust account nor have any other financial arrangements been made to assure construction of the electric lines.

(d) *Telephone.* (1) Is telephone service now, or will it be, available? Who will furnish the service?

(2) Have the service lines been extended in front of, or adjacent to, each of the lots? If not, when, and under what conditions, will construction be started and when will service be available (month and year)?

(3) If the service lines have not been extended in front of, or adjacent to, each lot, will the purchaser be responsible for any construction costs? If so, what is the utility company's policy and charges for extension of service lines? Based on that policy, what would be the cost to the purchaser of extending service lines to the most remote lot in this Report?

(e) *Fuel or other energy source.* (1) What fuel, or other energy source, will be available for heating, cooking, etc. in the subdivision? If other than electricity is to be used, describe the availability of the fuel or other energy source. Give the name and address of the supplier. If the fuel is natural gas, when will the mains be installed to the lots? What is the cost to the purchaser for installation fees and connection fees? If oil or propane gas will be used, include the cost of a storage tank.

(2) [Reserved]

§ 1710.112 Financial information.

(a) The information required by paragraphs (b) and (c) of this section need appear only if the answer to the question is an affirmative one.

(b) Has the developer had a deficit in retained earnings or experienced an operating loss during the last fiscal year or, if less than a year old, since its formation? If so, include a statement to

the effect that this may affect the developer's ability to complete promised facilities and to discharge financial obligations. This statement may be omitted if:

(1) All facilities, utilities and amenities proposed to be completed by the developer in the Property Report and sales contract have been completed so that the lots included in the Statement of Record are immediately usable for the purpose for which they are sold, or if:

(2) The developer is contractually obligated to the purchaser to complete all facilities, utilities and amenities promised by it in the Statement of Record, and:

(i) The developer has made financial arrangements, such as the posting of surety bonds (corporate or individual notes or bonds are not acceptable), irrevocable letters of credit, escrow or trust accounts, to assure that the facilities, utilities and amenities will be completed by the dates set out in the Property Report or contract;

(ii) The sales contract provides for delivery of a deed within 180 days of the signing of the contract which conveys title free of any mortgage or lien, or the developer has filed an assurance of title agreement with OILSR as outlined in §1710.212(e); and

(iii) Any down payments or deposits are held in an escrow or trust account.

(c) If the developer's financial statements have been audited, did the accountant qualify the opinion or decline to give an opinion? If so, why was the opinion qualified or declined?

(d) The following statement shall appear:

A copy of our financial statements for the period ending _____ is available from us upon request.

(e) The information furnished in §1710.212(b) may necessitate a warning as to costs and/or feasibility of the completion of the subdivision.

[44 FR 21453, Apr. 10, 1979, as amended at 49 FR 31370, Aug. 6, 1984]

§ 1710.113 Local services.

(a) *Fire protection.* Describe the availability of fire protection and indicate whether it is available year round.

§ 1710.114

24 CFR Ch. X (4-1-11 Edition)

(b) *Police protection.* Describe the availability of police protection.

(c) *Schools.* State whether elementary, junior high and senior high schools are available to residents of the subdivision. Is school bus transportation available from within the subdivision?

(d) *Hospital.* Give the name and location of the nearest hospital and state whether ambulance service is available.

(e) *Physicians and dentists.* State the location of the nearest physicians' and dentists' offices.

(f) *Shopping facilities.* State the location of the nearest shopping facilities.

(g) *Mail service.* If there is no mail service to the subdivision, describe the arrangements the purchasers must make to receive mail service.

(h) *Public transportation.* Is there public transportation available in the subdivision or to nearby towns? If not, give the location of the nearest public transportation and the distance from the subdivision.

§ 1710.114 **Recreational facilities.**

(a) *Recreational facilities to be covered.* Unless otherwise indicated, all information required by paragraphs (b) and (c) of this section shall be provided for only those recreational facilities which

(1) The developer is contractually responsible to provide or complete and which are:

(i) Within, adjacent or contiguous to the subdivision, and

(ii) Maintained substantially for the use of lot owners; or

(2) For which a third party is responsible and which are:

(i) Within, adjacent or contiguous to the subdivision, and

(ii) Maintained substantially for the use of lot owners.

(b) *Recreational facility chart.* Complete the below chart in accordance with the instructions which follow it. This chart shall immediately follow the §1710.114 heading. Limit the chart to facilities provided essentially for use of lot buyers.

Facility	Percentage of construction now complete	Estimated date of start of construction (month/year)	Estimated date available for use (month/year)	Financial assurance of completion	Buyer's annual cost or assessments
----------	---	--	---	-----------------------------------	------------------------------------

(1) *Facility.* Identify each recreational facility. Identify closely related facilities (e.g., swimming pool and bathhouse) separately only if their availability dates differ. If any recreational facility is not owned by the developer, insert a warning below the chart phrased substantially as follows:

“We do not own the (name of facility or facilities) so we can not assure its (their) continued availability.”

(2) *Percent complete.* State the present percentage of completion of construction for each recreational facility.

(3) *Estimated date of start of construction.* Insert the estimated date of the start of construction for the facility (month and year).

(4) *Estimated date available for use.* If the construction of the facility is not complete or if it is not available to lot owners for its intended use, indicate the estimated date (month and year) that the facility will be available for

use. If the “estimated date available for use” for any facility has been amended to delay it to a later date, indicate such delay in a statement immediately below the chart. Underline the response.

This statement shall include the name of the facility and the prior estimated availability date, and it shall be referenced to the appropriate facility listed on the chart by use of an asterisk or other appropriate symbol. If a facility is 100 percent completed and in use, no date is needed.

(5) *Financial assurance of completion.* If the construction of the facility is not complete, state whether there is any financial assurance of completion. If none, state “none”. If such exists, state the type of assurance (i.e. bond, escrow, or trust). If no documentation for such assurance has been provided in §1710.214 of the Statement of Record, then do not indicate such assurance on

the chart, but in place of such assurance on the chart state "none".

(6) *Buyer's annual cost or assessments.* State the lot buyer's annual cost or assessments for using the facility. These costs should include any applicable property owners' association assessment, and the developer's maintenance assessment. If the cost information is lengthy, you may use an asterisk or other appropriate symbol and include the cost information in a paragraph below the chart.

(c) Information to be provided below the recreational facility chart and related warnings.

(1) *Constructing the facilities.* If the facilities are not complete, indicate who is responsible for the construction of the facilities. Indicate whether the purchaser will be required to pay any of the cost of construction of these facilities (estimate and disclose such cost, if any).

(2) *Maintaining the facilities.* Indicate who is responsible for the operation and maintenance of these facilities.

(3) *Facilities which will be leased to lot purchasers.* If no facilities covered here will be leased to a Property Owners' Association or other lot owners in the subject subdivision, omit this caption and any information requested under it from the Property Report. If such leases exist or are anticipated, state which facilities are or will be leased and indicate the term of the lease. Also, state whether the lot owners will have an opportunity to terminate or ratify the lease after control of the Property Owners' Association is turned over to them. Indicate whether the owner of a recreational facility leased to the Property Owners' Association or other lot owners may encumber it and whether the holders of such encumbrances may acquire the leased facilities and not honor the lease. Indicate whether the lease payments may be increased on an escalating or other basis and what costs or expenses, if any, will be borne by the owner. State whether the lease can be assigned or sublet. State how the lease can be terminated.

(4) *Transfer of the facilities.* If there are presently any liens or mortgages on any of these recreational facilities, describe such liens or mortgages. If the developer, or owner of the subdivision,

their principals, or subsidiaries, intend to transfer the title of a listed recreational facility in the future, explain at what time, by what type of conveyance, and to whom such transfer will be made. Disclose any adverse effects on, or cost to, lot purchasers which may be caused by such transfer. If any facility is to be transferred to lot owners as a Property Owners' Association or otherwise, state whether the facility will be transferred free and clear of all liens and encumbrances. If not, state the amount of the encumbrance to be assumed and disclose any contractual conditions on such transfer which relate to lot purchasers.

(5) *Permits.* If the necessary permits have not been obtained for the construction and/or use of the facilities, identify the facilities for which such permits have not been obtained and include the following statement, or one substantially the same, in the narrative under the caption "Permits".

"The (identify the permit or license) has not been obtained and therefore there is no assurance that the lot owners will be able to use the (identify the facility)".

(6) *Who may use the facilities.* Indicate who will be permitted to use the recreational facilities (e.g., lot owners, their guests, employees of developer, general public, etc.). If the general public will be permitted to use the facilities include the following statement in the narrative under the caption "Who may use the facilities":

"The (identify the facility) is open to use by the general public and their use of the facility may limit use of it by lot owners".

[44 FR 21453, Apr. 10, 1979, as amended at 45 FR 40489, June 13, 1980; 50 FR 10942, Mar. 19, 1985]

§ 1710.115 Subdivision characteristics and climate.

(a) *General topography.* What is the general topography and the major physical characteristics of the land in the subdivision? State the percentage of the subdivision which is to remain as natural open space and as developed parkland. Are there any steep slopes, rock outcroppings, unstable or expansive soil conditions, etc., which will necessitate the use of special construction techniques to build on, or use, any

lot in the subdivision? If so, identify the lots affected, and describe the techniques recommended. If any lots in the subdivision have a slope of 20%, or more, include a warning that "Some lots in this subdivision have a slope of 20%, or more. This may affect the type and cost of construction."

(b) *Water coverage.* Are any lots, or portions of any lots, covered by water at any time? What lots are affected? When are they covered by water? How does this affect their use for the purpose for which they are sold? Can the condition be corrected? At what cost to the purchaser?

(c) *Drainage and fill.* Identify the lots which require draining or fill prior to being used for the purpose for which they are being sold. Who will be responsible for any corrective action? If the purchaser is responsible, what are the estimated costs?

(d) *Flood plain.* Is the subdivision located within a flood plain or an area designated by any Federal, State or local agency as being flood prone? What lots are affected? Is flood insurance available? Is it required in connection with the financing of any improvements to the lot? What is the estimated cost of the flood insurance?

(e) *Flooding and soil erosion.* (1) Does the developer have a program which provides, or will provide, at least minimum controls for soil erosion, sedimentation or periodic flooding throughout the subdivision?

(2) If there is a program, describe it. Include in the description information as to whether the program has been approved by the appropriate government officials; when it is to start; when it is to be completed (month and year); whether the developer is obligated to comply with the program and whether there is any financial assurance of completion.

(3) If there is no program or if the program has not been approved by the appropriate officials or if the program does not provide minimum protection, include a statement to the effect that the measures being taken may not be sufficient to prevent property damage or health and safety hazards. (A minimum program will usually provide for:

(i) Temporary measures such as mulching and seeding of exposed areas

and silt basins to trap sediments in runoff water, and

(ii) Permanent measures such as sodding and seeding in areas of heavy grading or cut and fill along with the construction of diversion channels, ditches, outlet channels, waterway stabilizers and sediment control basins.)

(f) *Nuisances.* Are there any land uses which may adversely affect the subdivision (e.g., unusual or unpleasant noises or odors, pollutants or nuisances such as existing or proposed industrial activity, military installations, airports, railroads, truck terminals, race tracks, animal pens, noxious smoke, chemical fumes, stagnant ponds, marshes, slaughterhouses and sewage treatment facilities)? If any nuisances exist, describe them. If there are none, state there are no nuisances which affect the subdivision.

(g) *Hazards.* (1) Are there any unusual safety factors which affect the subdivision (e.g., dilapidated buildings, abandoned mines or wells, air or vehicular traffic hazards, danger from fire or explosion or radiation hazards)? Is the developer aware of any proposed plans for construction which may create a nuisance or safety hazard or adversely affect the subdivision? If there are any existing hazards or if there is any proposed construction which will create a nuisance or hazard, describe the hazard or nuisance. If there are no existing or possible future hazards, state that there are none.

(2) Is the area subject to natural hazards or has it been formally identified by any Federal, State or local agency as an area subject to the frequent occurrence of natural hazards (e.g., tornadoes, hurricanes, earthquakes, mudslides, forest fires, brush fires, avalanches, flash flooding, etc.)? If the jurisdiction in which the subdivision is located has a rating system for fire hazard, state the rating assigned to the land in the subdivision and explain its meaning.

(h) *Climate.* What are the average temperature ranges, summer and winter, for the area in which the subdivision is located (i.e., high, low and mean)? What is the average annual rainfall and snowfall?

(i) *Occupancy*. How many homes are occupied on a full- or part-time basis as of (date of submission)?

§ 1710.116 Additional information.

(a) *Property Owners' Association*. (1) Will there be a property owners' association for the subdivision? Has it been formed? What is its name? Is it operating? If not yet formed, when will it be formed? Who is responsible for its formation?

(2) Does the developer exercise, or have the right to exercise, any control over the Association because of voting rights or placement of officers or directors? For how long will this control last?

(3) Is membership in the association voluntary? Will non-member lot owners be subject to the payment of dues or assessments? What are the association dues? Can they be increased? Are members subject to special assessments? For what purpose? If membership in the association is voluntary and if the association is responsible for operating or maintaining facilities which serve all lot owners, include the following statement:

"Since membership in the association is voluntary, you may be required to pay a disproportionate share of the association costs or it may not be able to carry out its responsibilities."

(4) What are the functions and responsibilities of the association? Will the association hold architectural control over the subdivision?

(5) Are there any functions or services that the developer now provides at no charge for which the association may be required to assume responsibility in the future? If so, will an increase in assessments or fees be necessary to continue these functions or services?

(6) Does the current level of assessments, fees, charges or other income provide the capability for the association to meet its present, or planned, financial obligations including operating costs, maintenance and repair costs and reserves for replacement? If not, how will any deficit be made up?

(b) *Taxes*. (1) When will the purchaser's obligation to pay taxes begin? To whom are the taxes paid? What are the annual taxes on an unimproved lot

after the sale to a purchaser? If the taxes are to be paid to the developer, include a statement that "Should we not forward the tax funds to the proper authorities, a tax lien may be placed against your lot."

(2) If the subdivision is encompassed within a special improvement district or if a special district is proposed, describe the purpose of the district and state the amount of assessments. Describe the purchasers obligation to retire the debt.

(c) *Violations and litigations*. This information need appear only if any of the questions are answered in the affirmative. Unless the Secretary gives prior approval for it to be omitted, a brief description of the action and its present status or disposition shall be given.

(1) With respect to activities relating to or in violation of a Federal, state or local law concerned with the environment, land sales, securities sales, construction or sale of homes or home improvements, consumer fraud or similar activity, has the developer, the owner of the land or any of their principals, officers, directors, parent corporation, subsidiaries or an entity in which any of them hold a 10% or more financial interest, been:

(i) Disciplined, debarred or suspended by any governmental agency, or is there now pending against them an action which could result in their being disciplined, debarred or suspended or,

(ii) Convicted by any court, or is there now pending against them any criminal proceedings in any court? (OILSR suspension notices on preeffective Statements of Record and amendments need not be listed.)

(2) Has the developer, the owner of the land, any principal, any person holding a 10% or more financial or ownership interest in either, or any officer or director of either, filed a petition in bankruptcy? Has an involuntary petition in bankruptcy been filed against it or them or have they been an officer or director of a company which became insolvent or was involved, as a debtor, in any proceedings under the Bankruptcy Act during the last 13 years?

(3) Is the developer or any of its principals, any parent corporation or subsidiary, any officer or director a party to any litigation which may have a material adverse impact upon its financial condition or its ability to transfer title to a purchaser or to complete promised facilities? If so, include a warning which describes the possible effects which the action may have upon the subdivision.

(d) *Resale or exchange program.* (1) Are there restrictions which might hinder lot owners in the resale of their lots (e.g., a prohibition against posting signs, limitations on access to the subdivision by outside brokers or prospective buyers; the developer's right of first refusal; membership requirements)? If so, briefly explain the restrictions.

(2) Does the developer have an active resale program? If the answer is "no", include the following statement: "We have no program to assist you in the sale of your lot."

(3) Does the developer have a lot exchange program? If the answer is "yes", describe the program; state any conditions and indicate if the program reserves a sufficient number of lots to accommodate all those wishing to participate. If there is no program or if sufficient lots are not reserved, include one of the following statements as applicable: "We do not have any provision to allow you to exchange one lot for another" or "We do not have a program which assures that you will be able to exchange your lot for another."

(e) *Unusual situations.* This topic need appear only if one or more of the following cases apply to the subdivision, then only the applicable subject, or subjects, will appear.

(1) *Leases.* What is the term of the lease? Is it renewable? Is it recordable? Can creditors of the developer, or owner, acquire title to the property without any obligation to honor the terms of the lease? Are the lease payments a flat sum or are they graduated? Can the lessee mortgage or otherwise encumber the leasehold? Will the lessee be permitted to remove any improvements which have been installed when the lease expires or is terminated?

(2) *Foreign subdivision.* (i) Is the owner or developer of the subdivision a foreign country corporation? If legal action is necessary to enforce the contract, must it be taken in the courts of the country where the subdivision is located?

(ii) Does the country in which the subdivision is located have any laws which restrict, in any way, the ownership of land by aliens? If so, what are the restrictions?

(iii) Must an alien obtain a permit or license to own land, build a home, live, work or do business in the country where the subdivision is located? If so, where is such permit or license secured; for how long is it valid and what is its cost?

(3) *Time sharing.* (i) How is title to be conveyed? How many shares will be sold in each lot? How is use time allocated? How are taxes, maintenance and utility expenses divided and billed? How are voting rights in any Association apportioned? Are there management fees? If so, what are their amounts and how are they apportioned?

(ii) Is conveyance of any portion of the lot contingent upon the sale of the remaining portions? Is the initial buyer responsible for any greater portion of the expense than his normal share until the remaining interests are sold? If the purchase of any of the portions is financed, will the default of one owner have any effect upon the remaining owners?

(4) *Memberships.* (i) Does the purchaser receive any interest in title to the land? What is the term of the membership? Is it renewable? What disposition is made of the membership in the event of the death of the member? Are the lots individually surveyed and the corners marked? If not, how does the member identify the area which the member is entitled to use? What is the approximate square footage the member is entitled to use? Are there different classes of membership? How are the different classes identified and what are the differences between them?

(ii) If the member does not receive any interest in the title to the land, include a warning to the effect that "you receive no interest in the title to the

land but only the right to use it for a certain period of time.”

(f) *Equal opportunity in lot sales.* State whether or not the developer is in compliance with title VIII of the Civil Rights Act of 1968 by not directly or indirectly discriminating on the basis of race, religion, sex or national origin in any of the following general areas: Lot marketing and advertising, rendering of lot services, and in requiring terms and conditions on lot sales and leases.

An affirmative answer cannot be given if the developer, directly or indirectly, because of race, color, religion, sex or national origin is:

(1) Refusing to sell or lease lots after the making of a bona fide offer or to negotiate for the sale or lease of lots or is otherwise making unavailable or denying a lot to any person, or

(2) Discriminating against any person in the terms, conditions or privileges in the sale or leasing of lots or in providing services or facilities in connection therewith, or

(3) Making, printing, publishing or causing to be made, printed or published any notice, statement or advertisement with respect to the sale or leasing of lots that indicates any preference, limitation or discrimination against any person, or

(4) Representing to any person that any lot is not available for inspection, sale or lease when such lot is in fact available, or

(5) For profit, inducing or attempting to induce any person to sell or lease any lot by representations regarding the entry or non-entry into the neighborhood of a person or persons of a particular race, color, religion, sex or national origin.

(g) *Listing of lots.* Provide a listing of lots which shall consist of a description of the lots included in the Statement of Record by the names or number of the section or unit, if any; the block number, if any; and the lot numbers. The lots shall be listed in the most efficient and concise manner. If the filing is a consolidation, the listing shall include all lots registered to date in the subdivision, except any which have been deleted by amendment.

[44 FR 21453, Apr. 10, 1979, as amended at 49 FR 31370, 31371, Aug. 6, 1984]

§ 1710.117 Cost sheet, signature of Senior Executive Officer.

(a) *Cost sheet—Format.* (1) The cost sheet shall be prepared in accordance with the following format and paragraph (a)(2) of this section.

COST SHEET

In addition to the purchase price of your lot, there are other expenditures which must be made.

Listed below are the major costs. There may be other fees for use of the recreational facilities.

All costs are subject to change.

	Sales Price	
Cash Price of lot		\$.....
Finance Charge		\$.....
		<hr/>
Total		\$.....
		<hr/>
	Estimated one-time charges	
1. Water connection fee/installation or private well		\$.....
2. Sewer connection fee/installation of private on-site sewer system		\$.....
3. Construction costs to extend electric and/or telephone services		\$.....
4. Other (Identify)		\$.....
		<hr/>
		<hr/>
Total of estimated sales price and one-time charges		\$.....
		<hr/>
	Estimated monthly/annual charges, exclusive of utility use fees	
1. Taxes—Average unimproved lot after sale to purchaser		\$.....
2. Dues and assessments		\$.....

The information contained in this Property Report is an accurate description of our subdivision and development plans.

Signature of Senior Executive Officer

(2) *Cost sheet instructions.* (i) All amounts for cost sheet items will be entered before the purchaser signs the receipt. However, any costs that are identical for all lots may be pre-printed.

(ii) If a central water or sewer system will be used in all or part of the subdivision and a private system in all or other parts, then the portion that does not apply to the purchaser's lot shall be crossed out.

(iii) If individual private systems may be used prior to the availability of service from any central system and

§ 1710.118

24 CFR Ch. X (4-1-11 Edition)

the purchaser is not required to connect to any central system, both figures may be entered or only the highest cost figures may be used with a parenthetical explanation or footnote. If the purchaser is required to connect to any central system and discontinue the use of his private system when central service is available, both cost figures shall be given, together with an explanation or footnote.

(iv) If there is a one time, lump sum "availability fee" which is assessed to the purchaser in connection with a central utility, include under "other" and identify.

(v) Dues and assessments need be included only if they are involuntary regardless of use.

(vi) At the discretion of the Secretary, where there is extreme diversity in the figures for different areas of the subdivision, variations may be per-

mitted as to whether the figures will be printed, entered manually, or a range of costs used or any combination of these features.

(vii) The estimated annual taxes shall be based upon the projected valuation of the lot after sale to a purchaser.

(b) *Signature of the Senior Executive Officer.* The Senior Executive Officer or a duly authorized agent shall sign the property report. Facsimile signatures may be used for purposes of reproduction of the property Report.

[44 FR 21453, Apr. 10, 1979, as amended at 49 FR 31371, Aug. 6, 1984]

§ 1710.118 Receipt, agent certification and cancellation page.

(a) *Format.* The receipt, agent certification and cancellation page shall be prepared in accordance with the sample printed herein.

RECEIPT, AGENT CERTIFICATION AND CANCELLATION PAGE

PURCHASER RECEIPT

IMPORTANT: READ CAREFULLY

Name of subdivision _____
OILSR number _____ Date of report _____

We must give you a copy of this Property Report and give you an opportunity to read it before you sign any contract or agreement. By signing this receipt, you acknowledge that you have received a copy of our Property Report.

Received by _____ Date _____
Street address _____
City _____ State _____ Zip _____

If any representations are made to you which are contrary to those in this Report, please notify the:

Office of Interstate Land Sales Registration
HUD Building, 451 Seventh Street, S.W.
Washington, D.C. 20410

AGENT CERTIFICATION

I certify that I have made no representations to the person(s) receiving this Property Report which are contrary to the information contained in this Property Report.

Lot _____ Block _____ Section _____
Name of salesperson _____
Signature _____ Date _____

PURCHASE CANCELLATION

If you are entitled to cancel your purchase contract, and wish to do so, you may cancel by personal notice, or in writing. If you cancel in person or by telephone, it is recommended that you immediately confirm the cancellation by certified mail. You may use the form below.

Name of subdivision _____
Date of contract _____

This will confirm that I/we wish to cancel our purchase contract.

Purchaser(s) signature _____ Date _____

(b) The original and one copy of this page shall be attached to the Property Report delivered to prospective purchasers. Carbon paper may be inserted between the two so that after the purchaser has signed the receipt and the salesman has signed the certification, the copy can be detached and retained by the developer for a period of three years from the date of execution or the term of the contract, whichever is the longer. Upon demand by the Secretary, the developer shall, without delay, make the copies of these receipts and certifications available for inspection by the Secretary or the developer shall forward to the Secretary any of the receipts and certifications, or copies thereof, as the Secretary may specify.

(c) If the transaction takes place through the mails, the cost figures shall be entered and the person most active in dealing with the prospective purchaser shall sign the certification prior to mailing the Property Report to the purchaser. Otherwise, the certification shall be executed in the presence of the purchaser.

(d) The date of Report appearing on the receipt shall be the same as that appearing on the cover sheet of the Property Report.

(e) Notification of cancellation by mail shall be considered given at the time post-marked.

§ 1710.200 Instructions for Statement of Record, Additional Information and Documentation.

The Additional Information and Documentation portion of the Statement of Record shall contain the statements and documents required in §§ 1710.208 through 1710.219. Each section number and its associated heading and each paragraph letter or number and their associated subheadings or captions must appear in this portion. Following each heading, subheading, or caption printed in this portion, the registrant shall insert an appropriate response. If a heading, subheading, or caption does not apply to the subdivision, it shall be followed by the words "not applicable". Immediately after the page(s) on which

the section number and answers for that section appear, insert the information or documents which support that section. In addition to the statements and documentation expressly required there shall be added any further material, information, documentation and certifications as may be necessary in the public interest and for the protection of purchasers or to cause the statements made to be not misleading in the light of the circumstances under which they are made.

§ 1710.208 General information.

(a) *Administrative information.* (1) State whether the material represents an initial Statement of Record or a consolidated Statement of Record. If it is a consolidated Statement of Record, identify the original OILSR number assigned to the initial Statement of Record. State whether subsequent Statements of Record will be submitted for additional lots in the subdivision.

(2) Has the developer submitted a request for an exemption for the subdivision?

(3) List the states in which registration has been made by the developer for the sale of lots in the subdivision.

(4) If any State listed in paragraph (a)(3) of this section has not permitted a registration to become effective or has suspended the registration or prohibited sales, name the State involved and give the reasons cited by the State for their action.

(5) State whether the developer has made, or intends to make, a filing with the U.S. Securities and Exchange Commission (SEC) which is related in any way to the subdivision. If a filing has been made with the SEC, give the SEC identification number; identify the prospectus by name; date of filing and state the page number of the prospectus upon which specific reference to the subdivision is made. Any disciplinary action taken against the developer by the SEC should be disclosed in §§ 1710.116 and 1710.216.

(b) *Subdivision information.* (1) If this is a consolidated Statement of Record,

§ 1710.208

24 CFR Ch. X (4-1-11 Edition)

state the number of lots being added, the number of lots in prior Statements of Record and the new total number of lots. The Secretary must be able to reconcile the numbers stated here with the title evidence; the plat maps and the disclosure in §1710.108.

(2) State the number of acres represented by the lots in this Statement of Record. If this is a consolidated Statement of Record, state the number of acres being added, the number of acres in prior Statements of Record and the new total number of acres. State the total acreage owned in the subdivision, the number of acres under option or similar arrangement for acquisition of title to the land and the total acreage to be offered pursuant to the same common promotional plan.

(3) State whether any lots have been sold in this subdivision since April 28, 1969 and prior to registration with this Office. If they were sold pursuant to an exemption, identify the exemption provision and state whether an advisory opinion, exemption order or exemption determination was obtained with respect to those lots sales. Give the OILSR number assigned to the exemption, if any.

(c) *Developer information.* (1) State the name, address, Internal Revenue Service number and telephone number of the owner of the land. If the owner is other than an individual, name the type of legal entity and list the interest, and extent thereof, of each principal. Identify the officers and directors.

(2) If the developer is not the owner of the land, state the developer's name, address, Internal Revenue Service number and telephone number. If the developer is other than an individual, name the type of legal entity and list the interest, and the extent thereof, of each principal. Identify the officers and directors.

(3) If you wish to appoint an authorized agent, state the agent's name, address and telephone number and scope of responsibility. This shall be the party designated by the developer to receive correspondence, service of process and notice of any action taken by OILSR. In all Statements of Record, including those for foreign subdivisions, the authorized agent shall be a

resident of the United States. A change of the authorized agent will require an appropriate amendment.

(4) State whether the owner of the land, the developer, its parent, subsidiaries or any of the principals, officers or directors of any of them are directly or indirectly involved in any other subdivision containing 100 or more lots. If so, identify the subdivision by name, location, and OILSR number, if any.

(5) State whether the owner or developer is a subsidiary corporation. If either the owner or developer is a subsidiary corporation or if any of the principals of the owner or developer are corporate entities, name the parent and/or corporate entity and state the principals of each to the ultimate parent entity.

(d) *Documentation.* (1) Submit a copy of the property report, subdivision report, offering statement or similar document filed with the state or states with which the subdivision has been registered.

(2) Submit a copy of a general plan of the subdivision. This general plan must consist of a map, prepared to scale, and it must identify the various proposed sections or blocks within the subdivision, the existing or proposed roads or streets, and the location of the existing or proposed recreational and/or common facilities. In an initial filing, this map must at least show the area included in the Statement of Record. In a consolidated Statement of Record, show areas being added, as well as the areas previously registered. If a map of the entire subdivision is submitted with the initial Statement of Record, and if no substantial changes are made when material for a consolidated Statement of Record is submitted, the original map may be incorporated by reference.

(3)(i) If the developer is a corporation, submit a copy of the articles of incorporation, with all amendments; a copy of the certificate of incorporation or a certificate of a corporation in good standing and, if the subdivision is located in a state other than the one in which the original certificate of corporation was issued, a certificate of registration as a foreign corporation with the state where the subdivision is located.

(ii) If the developer is a partnership, unincorporated association, joint stock company, joint venture or other form of organization, submit a copy of the articles of partnership or association and all other documents relating to its organization.

(iii) If the developer is not the owner of the land, submit copies of the above documents for the owner.

[44 FR 21453, Apr. 10, 1979, as amended at 45 FR 40489, June 13, 1980; 49 FR 31371, Aug. 6, 1984]

§ 1710.209 Title and land use.

(a) *General information.* (1) State whether the developer has reserved the right to exchange or withdraw lots after a purchaser has signed a sales contract (e.g., for prior sales, failure to pass credit check). If yes, indicate this authority and make reference to the applicable paragraph in the sales contract or other document.

(2) State whether there is a provision giving purchasers an option to exchange lots. If yes, indicate this and make reference to the applicable paragraph in the sales contract or other document.

(3) State whether the developer knows of any instruments not of record which, if recorded, would affect title to the subdivision. If yes, copies of these instruments shall be submitted, except that copies of unrecorded contracts for sales of lots in the subdivision need not be submitted.

(4)(i) Identify the Federal, State and local agencies or similar organizations which have the authority to regulate or issue permits, approvals or licenses which may have a material effect on the developer's plans with respect to the proposed division of the land, and any existing or proposed facilities, common areas or improvements to the subdivision.

(ii) Describe or identify the land or facilities affected; the permit, approval or license required; and indicate whether the permit, approval or license has been obtained by the developer.

(iii) If no agency regulates the division of the land or issues any permits, approvals or licenses with respect to improvements, so state.

(iv) Answers must specifically cover the areas of environmental protection;

environmental impact statements; and construction, dredging, bulkheading, etc. that affect bodies of water within or around the subdivision. Also include licenses or permits required by water resources boards, pollution control boards, river basin commissions, conservation agencies or similar organizations.

(5) State whether it is unlawful to sell lots prior to the final approval and recording of a plat map in the jurisdiction where the subdivision is located.

(b) *Title evidence.* (1) Submit title evidence that specifically states the status of the legal and equitable title to the land comprising the lots covered by the Statement of Record and any common areas or facilities disclosed in the Property Report. Title evidence need not be submitted for those common areas and facilities which are not owned by the developer.

(2) Acceptable title evidence shall be dated no earlier than 20 business days preceding the date of the filing of the Statement of Record with the Secretary. Previously issued title evidence may be updated to the date referred to in the preceding sentence by endorsements or attorneys' opinions of title.

(3) The developer shall amend the title evidence to reflect the change in status of title of any previously registered, reacquired lots unless their status is at least as marketable as they were when first offered for sale by the developer as registered lots.

(c) *Forms of acceptable title evidence.*

(1) An original or a copy of a signed owner's or mortgagee's policy of title insurance, title commitment, certificate of title or similar instrument issued by a title company authorized by law to issue such instruments in the state in which the subdivision is located. Title evidence that limits insurance or negligence liability to amounts less than the market value of the subject land at the time of its acquisition by the subdivision owner is not acceptable;

(2) A legal opinion stating the condition of title, prepared and signed by an attorney at law experienced in the examination of titles and a member of the Bar in the state in which the property is located. The title opinion may be based on a Torrens land registration

system certificate of title, or similar instrument, provided it meets all general title evidence requirements of this section and a copy of the registration certificate of title is submitted. Title opinions that limit negligence liability to amounts less than the market value of the subject land at the time of its acquisition by the subdivision owner are not acceptable.

(d) *Title searches.* The required evidence of the status of title shall be based on a search of all public records which may contain documents affecting title to the land or the developer's ability to deliver marketable title. The search must cover a period which is required or generally considered adequate for insuring marketability of title in the jurisdiction in which the subdivision is located. Such search shall include an examination of at least the following documents:

- (1) The records of the recorder of deeds or similar authority;
- (2) U.S. Internal Revenue Liens;
- (3) The records of the circuit, probate, or other courts including Federal courts and bankruptcy or reorganization proceedings which have jurisdiction to affect the title to the land;
- (4) The tax records;
- (5) Financing statements filed pursuant to the Uniform Commercial Code or similar law. If it is held that the financing statements do not affect the title of the land, include a statement of the legal authority for that opinion.

This search may be accomplished through the use of a title insurance company title plant, the information in which is based on current searches of the appropriate and necessary documents, including as a minimum those listed immediately above. For any attorney's title opinion based on Torrens certificates of title, the title search need only go beyond the original time of registration of the certificate of title for those types of encumbrances which were not conclusively settled by the proceedings at the time of such registration. In such cases, the required statement shall clearly reflect the documents and periods searched.

(e) *Items to be included in the title evidence.* The acceptable title evidence must include the following information, instruments and statements and

need not be repeated or duplicated elsewhere in the Statement of Record.

(1) A legal description of the land on which the lots, common areas, and facilities covered by the title evidence are located. This legal description shall be adequate for conveying land in the jurisdiction in which the subdivision is located. If this legal description is based on a recorded plat, the lot numbers, recording place, book name, book number, and page number shall be stated in the description. If this legal description is given by metes and bounds, the title evidence shall include or be accompanied by a certified statement of the preparer of the title evidence, a licensed attorney, or an engineer or surveyor, indicating that all subject lots, common areas, and common facilities are encompassed within the metes and bounds description in the evidence. If at any time after the submission of the legal description required above, the description of the subject land is changed or found to be in error, a correcting amendment shall be made to the Statement of Record.

(2) The name of the person(s) or other legal entity(ies) holding fee title to the property described.

(3) The name of any person(s) or other legal entity(ies) holding a leasehold estate or other interest of record in the property described.

(4) A listing of any and all exceptions or objections to the title, estate or interest of the person(s) or legal entity(ies) referred to in paragraph (e)(2) or (e)(3) of this section, including any encumbrances, easements, covenants, conditions, reservations, limitations or restrictions of record. (Any reference to exceptions or objections to title shall include specific references to the instruments in the public records upon which they are based). When an objection or exception to title affects less than all of the property covered by this Statement of Record, the title evidence shall specifically note what portion of the property is so affected.

(5) Copies of all instruments in the public records specifically referred to in paragraph (e)(4) of this section. (Abstracts of such instruments are acceptable if prepared by an attorney or professional or official abstractor qualified and authorized by law to prepare

and certify such abstracts and if the abstracts contain a material portion of the recorded instruments sufficient to determine the nature and effect of such instruments.) Also include copies of any release provisions, relating to encumbrances on the property described, which are not included in the documents otherwise required by this section.

(6) If an attorney's title opinion has been submitted pursuant to this section which has been based on a Torrens land registration certificate of title, submit a copy of such certificate.

(f) *Supplemental title information.* (1) If there is a holder of an ownership interest in the land other than the developer, submit a copy of any documentation which evidences the developers' authorization to develop and/or sell the land.

(2) Submit copies of any trust deeds, deeds in trust, escrow agreements or other instruments which purport to protect the purchaser in the event of default or bankruptcy by the developer on any instrument or instruments which create a blanket encumbrance upon the property unless they have been previously provided as part of "title evidence" submitted pursuant to paragraph (e) of this section.

(3)(i) Submit copies of all forms of contracts or agreements and notes to be used in selling or leasing lots. The contracts or agreements, including promissory notes, must contain the following language in boldface type (which must be distinguished from the type used for the rest of the contract) on the face or signature page above all signatures:

You have the option to cancel your contract or agreement of sale by notice to the seller until midnight of the seventh day following the signing of the contract or agreement.

If you did not receive a Property Report prepared pursuant to the rules and regulations of the Office of Interstate Land Sales Registration, U.S. Department of Housing and Urban Development, in advance of your signing the contract or agreement, the contract or agreement of sale may be cancelled at your option for two years from the date of signing.

(ii) If the purchaser is entitled to a longer revocation period by operation of State law or the Act, that period be-

comes the Federal revocation period and the contract or agreement must reflect the requirements of the longer period, rather than the seven days. This language shall be consistent with that shown on the Cover Page (see §1710.105).

(iii) The revocation provisions may not be limited or qualified in the contract or other document by requiring a specific type of notice or by requiring that notice be given at a specified place.

(iv) If it is represented that the developer will provide or complete roads or facilities for waters, sewer, gas, electric service or recreational amenities, the contract must contain a provision that the developer is obligated to provide or complete such roads, facilities and amenities (see §1715.15(f)).

(4) Submit copies of deeds and leases by which the developer will lease or convey title to the lots to purchasers or lessees.

(g) *Plat maps, environmental studies and restrictions*—(1) *Plat maps.* (i) In those jurisdictions where it is unlawful to sell lots prior to final approval and recording of the plat, and in those cases where a plat has been recorded, submit a copy of the recorded plat. This plat should be an exact copy of the recorded document. It should reflect the signatures of the approving authorities and bear a stamp or notation by the recorder of deeds, or similarly constituted officer, as to the recording data.

(ii) If the plat has not been approved by the local authorities nor recorded, and if it is not unlawful to sell lots prior to final approval and recording, submit a map which has been prepared to scale and which shows the proposed division of the land, the lot dimensions and their relation to proposed or existing streets and roads. The map shall contain sufficient engineering data to enable a surveyor to locate the lots.

(iii) Whether recorded or unrecorded, the plat or map should show:

(A) The dimensions of each lot, stated in the standard unit of measure acceptable for such purposes in the political subdivision where the land is located.

§ 1710.210

(B) A clear delineation of each of the lots and any common areas or facilities.

(C) Any encroachments or rights-of-way on, over, or under the land, or a notation of these items together with the identity of the lots affected.

(D) The courses, distances and monuments, natural or otherwise, of the land's boundaries; contiguous boundaries and identification or ownership of adjoining land and names of abutting streets, ways, etc.

(E) The location of the section or unit encompassing the lots in relationship to the larger tract, or tracts, in the subdivision.

(F) The delineation of any flood plains or flood control easements affecting any of the lots.

(iv) The plat, or map shall be prepared by a licensed surveyor or engineer.

(v) If all lots on each page of the plat are not included in the Statement of Record with which the plat or map is submitted, then the lots which are to be included in the Statement of Record shall be identified on the plat or map; a legend describing the method of identification shall be entered on the face of the plat or map and the number of lots so identified entered in the lower right hand corner of the plat map. The Secretary must be able to reconcile the totals of these numbers with the information given in §§ 1710.108 and 1710.208 of the Statement of Record and the title evidence.

(2) *Environmental impact study.* If the developer is aware of any environmental impact study which considers the effect of the subdivision on the environment, submit a summary of that study.

(3) *Restrictions or covenants.* Submit a copy of any recorded or proposed restrictions or covenants for the subdivision if not submitted elsewhere in this Statement of Record.

A copy of these restrictions or covenants shall be delivered to a prospective purchaser upon request. A supply shall be maintained at whatever place or places as will be necessary to allow immediate delivery upon request.

[44 FR 21453, Apr. 10, 1979, as amended at 45 FR 40489, June 13, 1980; 49 FR 31371, Aug. 6, 1984]

24 CFR Ch. X (4-1-11 Edition)

§ 1710.210 Roads.

(a) State the estimated cost to the developer of the proposed road system.

(b) If the developer is to complete any roads providing access to the subdivision, submit copies of any bonds or escrow agreements which have been posted to guarantee completion thereof.

(c) Submit copies of any bonds or escrow agreements which have been posted to assure completion of the roads within the subdivision.

(d) If the interior roads are to be maintained by a public authority, submit a copy of a letter from that authority which states that the roads have been, or the conditions upon which they will be, accepted for maintenance and when.

§ 1710.211 Utilities.

(a) *Water.* (1) State the estimated cost to the developer of the central water system.

(2) If water is to be supplied by a central system, furnish a letter from the supplier that it will supply the water. If the system is operated by a governmental division or by an entity whose operations are regulated by a governmental agency but which is not affiliated with or under the control of the developer, the letter shall include a statement that the supply of water will be sufficient to serve the anticipated population of the subdivision or how many homes or connections it can and will serve and that the water is tested at regular intervals and has been found to meet all standards for a public water supply.

(3) If the water is to be supplied by individual wells, by an entity which is not regulated by a governmental agency, by the developer or by an entity which is affiliated with or controlled by the developer, submit a copy of any engineers' reports or hydrological surveys which indicate there is a sufficient supply of water to serve the anticipated population of the subdivision.

(4) If the supplier of water is not in one of the categories in paragraph (a)(2) of this section, submit a copy of a letter or report from a cognizant health officer, or from a private laboratory licensed by the state to perform tests and issue reports on water, to the

effect that the water was found to meet all drinking water standards required by the state for a public water system.

(5) If any bond, escrow agreement or other financial assurance of the completion of the central system, including any phases which are to be constructed in the future, has been posted by the developer or an entity not regulated by a government agency, furnish a copy of the document.

(6) Furnish a copy of any permits which have been obtained by the developer or any entity affiliated with or under the control of the developer in connection with the construction and operation of the central system. If a permit is required to install individual wells, submit a letter from the proper authority which states the requirements for obtaining the permit and that there is no objection to the use of individual wells in the subdivision.

(7) Furnish a copy of any membership agreement or contract which allows or requires lot owners to use the central water system. If this document is furnished elsewhere in the Statement of Record, reference to it may be made here.

(b) *Sewer.* (1) State the estimated cost to the developer of the central sewer system.

(2) If sewage disposal is to be by individual on-site systems, furnish a letter from the local health authorities giving general approval to the use of these systems in the subdivision or giving specific approval for each and every lot.

(3) If sewage disposal is to be through a central system which is owned and operated by a governmental division, or by an entity whose operations are regulated by a governmental agency but which is not affiliated with, or under the control of, the developer, furnish a letter from the entity that it will provide this service and that its treatment facilities have the capacity to serve the anticipated population of the subdivision or how many homes or connections it can and will serve.

(4) Furnish a copy of any permits obtained by the developer or any entity affiliated with or under the control of the developer, for the construction and operation of the central sewer system or construction and use of any other

method of sewage disposal contemplated for the subdivision except those to be obtained by individual lot owners at a later date.

(5) If any bond, escrow agreement or other financial assurance of the completion of the central system or other system for which the developer is responsible, and any future expansion, has been posted, furnish a copy of the document.

(6) Furnish a copy of any membership agreement of contract which allows, or requires, the lot owners to use the central system. If this document is furnished elsewhere in the Statement of Record, it may be incorporated here by reference.

(c) *Electricity.* Give an estimate of the total construction cost to be expended by the developer and submit any instrument providing financial assurance of completion of the facilities which has been posted by the developer.

(d) *Telephone.* Give an estimate of the total construction cost to be expended by the developer and submit a copy of any instrument providing financial assurance of the completion of the facilities which has been posted by the developer.

§ 1710.212 Financial information.

(a) *Financing of improvements.* Describe the financing plan that is to be used in financing on-site or off-site improvements proposed in the Statement of Record.

(b) Complete the following format:

(1) Estimated date for full completion of amenities

(2) Projected date for complete sell out of subdivision

(3) Cost and expense recap for lots included in this Statement of Record:

(If the subdivision or common promotional plan contains, or will contain, 1000 or more lots, furnish this information in its entirety. If the subdivision or common promotional plan contains, or will contain, less than 1,000 lots, only paragraphs (b)(3) (iii) and (iv) need be completed.)

(i) Land acquisition cost or current fair market value of land.

(ii) Development and improvement costs (include the estimated cost of such items as roads, utilities, and

§ 1710.212

24 CFR Ch. X (4-1-11 Edition)

amenities which the developer will incur).

(iii) Estimated marketing and advertising costs.

(iv) Estimated sales commission.

(v) Interest (include cost in financing the land purchase, improvements, or other borrowings).

(vi) Estimated other expenses (include general costs, administrative costs, profit, etc.).

(vii) Total.

(4) Total land sales revenue:

(i) Estimated total land sales income.

(ii) Estimated other income.

(iii) Total income.

(c) *Financial statements.* (1) Submit a copy of the developer's financial statements for the last full fiscal year. These statements shall be prepared in accordance with generally accepted accounting principles as prescribed by the Financial Accounting Standards Board and generally accepted auditing standards as prescribed by the American Institute of Certified Public Accountants, and shall be audited by an independent licensed public accountant. They shall include a balance sheet, a statement of profit and loss, a statement of changes in financial condition and a certified opinion by the accountant. The statements shall be no more than six months old on the date the Statement of Record is submitted.

(2) If the audited statements are more than six months old at the date of submission of the Statement of Record, or if the last full fiscal year has ended within the last 90 days and audited Statements are not yet available, the developer may submit a copy of the audited statements for the previous full fiscal year and supplement them with unaudited, interim statements so that the financial information is no more than six months old on the date that the Statement of Record is submitted. The interim statements may be prepared by company personnel but must contain a balance sheet, a statement of profit and loss and a statement of changes in financial condition and be prepared in accordance with generally accepted accounting principles.

(d) *Annual report.* (1) Each year after the initial effective date, the developer shall submit a copy of its latest finan-

cial statements. These statements must meet the standards set out in §1710.212(c)(1), unless the developer has qualified for an exception under §1710.212(e), and must be submitted within 120 days after the close of the developer's fiscal year.

(2) If a developer has submitted its latest statements with a consolidated filing since the close of its fiscal year and prior to the end of the 120 day period, a second submission of the statements to comply with this section is not necessary.

(3) If the developer no longer has an active sales program on the date this report is due, the information set forth in §1710.310(c)(7)(iii) may be furnished in lieu of this report.

(e) *Exceptions.* (1) If the developer does not have audited financial statements and the criteria in one of the following exceptions are met, statements need not be audited and certified but must meet all of the other requirements set forth in paragraphs (c)(1) and (2) of this section.

(2) The term "conveys title free of any mortgage or lien" in these exceptions is not intended to prohibit the taking of an instrument as security for the lot purchase price after title is conveyed. For the purposes of these exceptions, these definitions shall apply:

(i) "Deed" shall mean a warranty deed, or its equivalent, which conveys title free and clear of liens and encumbrances.

(ii) "Assurance of Title Agreement" shall mean a legal arrangement whereby the purchaser is guaranteed a deed upon payment of no more than the full purchase price of the lot (e.g. subdivision trust). In addition to a copy of any Assurance of Title Agreement, the Secretary may require additional documentation such as an attorney's opinion letter to assure that the purchaser's title is fully protected.

(iii) "Date of contract" shall mean the date on which the contract or agreement is signed by the purchaser.

(iv) "Escrow or trust account as to down payments and deposits" shall mean an account, established in accordance with local real estate laws or regulations, which assures the return to the purchaser of any monies paid in the event title is not delivered to the

purchaser in accordance with the terms of the contract.

(3) The exceptions are:

(i) The aggregate sales price of all lots offered pursuant to a common promotional plan equals \$500,000.00 or less; or

(ii) Each of the following conditions of paragraphs (e)(3)(ii)(A) and (B) are met, plus the conditions of one of paragraphs (e)(3)(ii)(C), (D), or (E):

(A) Downpayments and deposits are held in an escrow or trust account.

(B) The contract provides for delivery of a deed which conveys title free of any mortgage or lien within 180 days of the signing of the contract. (In lieu of delivery of a deed, the developer may submit to OILSR an Assurance of Title Agreement.)

(C) The aggregate sales prices of all lots offered pursuant to a common promotional plan is at least \$500,000 but less than \$1,500,000.

(D) All facilities, utilities and amenities proposed by the developer in the Property Report or sales contract have been completed so that the lots in the Statement of Record are immediately usable for the purpose for which they are sold.

(E) (1) The developer is contractually obligated to the purchaser to complete all facilities, utilities and amenities proposed by the developer in the Property Report and sales contract so that all lots included in the Statement of Record will be usable for the purpose for which they are sold by the dates set out in the Property Report, and;

(2) The developer has made financial arrangements, such as the posting of surety bonds (corporate bonds or individual notes or bonds are not acceptable), irrevocable letters of credit or the establishment of escrow or trust accounts, which assure completion of all facilities, utilities and amenities proposed by the developer in the Property Report or contract.

(f) *Newly-formed entity.* If the developer is newly formed or has not had any significant operating experience, an audited or unaudited balance sheet and statements of receipts and disbursements of funds may be submitted.

(g) *Use of parent company statements.* If the developer is a subsidiary company and does not have audited finan-

cial statements, the Secretary may permit the use of the audited and certified statements of the parent company: *Provided*, That those statements are accompanied by an unconditional guaranty that the parent shall perform and fulfill the obligations of the subsidiary. If this procedure is adopted, the developer shall submit the following:

(1) The audited and certified financial statements of the parent company, together with interim statements if necessary, which comply with §1710.212(c).

(2) A properly executed guaranty in a form acceptable to the Secretary.

The disclosure information required in §1710.112 shall be appropriately amended to reference the parent company and not the developer and must include a statement to the effect that the developer's parent company (insert name) has entered into an unconditional guaranty to perform and fulfill the obligations of the developer.

(h) *Opinions.* If the accountant qualifies or disclaims his opinion, the Secretary may accept the statements and require such additional disclosure as the Secretary deems necessary in the public interest or for the protection of purchasers.

(i) *Copies for prospective purchasers.* Copies of the financial statements filed with the Statement of Record shall be made available to prospective purchasers upon request. A supply of the latest submitted statements shall be maintained at whatever place, or places, as is necessary to allow immediate delivery upon request by a prospective purchaser. These statements shall contain financial information only and shall not include any promotional material such as that usually set forth in annual reports.

(j) *Change from audited to unaudited statements.* (1) Developers who file audited statements must continue with audited statements throughout the duration of the registration unless, at a later date, the developer submits amendments which demonstrate to the satisfaction of the Secretary that it then qualifies for an exception from audited statements under paragraph (e)(3)(ii) of this section. For purposes of paragraph (e)(3)(ii)(C) of this section,

§ 1710.214

the Secretary will consider the aggregate sales prices of only the lots yet to be sold, and may consider whether any additions to the subdivisions or reacquisitions of lots already sold would be likely to cause the dollar limits to be exceeded.

(i) The aggregate sales prices of the lots yet to be sold in the subdivision has been reduced to less than \$1,500,000.00, and that it will not exceed this amount through further additions to the subdivision, or through the reacquisition of lots already sold, and;

(ii) The sales contract provides for delivery of a deed within 120 days of the date of the contract which conveys title free and clear of any mortgage or lien or the developer files an Assurance of Title Agreement with OILSR, and;

(iii) Any down payments or deposits are held in an escrow or trust account, or;

(iv) The developer then qualifies for exception (e)(3)(iii) or (e)(3)(iv) above.

(2) The Secretary may allow a developer, who has made sales prior to registration, to submit unaudited statements under the provisions of paragraph (j)(1)(i) of this section. The developer must demonstrate to the satisfaction of the Secretary that the acceptance of unaudited statements would not be a detriment to the public interest or to the protection of purchasers.

[44 FR 21453, Apr. 10, 1979, as amended at 45 FR 40490, June 13, 1980; 49 FR 31372, Aug. 6, 1984; 50 FR 10942, Mar. 19, 1985]

§ 1710.214 Recreational facilities.

(a) Submit a synopsis of the proposed plans and estimated cost of any proposed or partially constructed recreational facility disclosed in §1710.114. This item should include the general dimensions and a brief description of the facility but it should not include blueprints or similar technical materials.

(b) Submit a copy of any bond or escrow arrangements to assure completion of the recreational facilities disclosed in §1710.114 which are not structurally complete.

(c) Submit a copy of the lease for any leased recreational facility.

24 CFR Ch. X (4-1-11 Edition)

§ 1710.215 Subdivision characteristics and climate.

(a) Submit *two* copies of a current geological survey topographic map, or maps, of the largest scale available from the U.S. Geological Survey with an outline of the entire subdivision and the area included in this Statement of Record clearly indicated. Photo copies made by the developer are not acceptable. Do not shade the areas on the maps which have been outlined.

(b) If drainage facilities are proposed but not yet completed, submit a synopsis of the developer's proposed plans which includes a description of the system of collecting surface waters; a description of the steps to be taken to control erosion and sedimentation and the estimated cost of the drainage facilities.

(c) Submit copies of any bonds, escrow or trust accounts or other financial assurance of completion of the drainage facilities.

(d) State whether the jurisdiction in which the subdivision is located has a system for rating the land for fire hazards.

§ 1710.216 Additional information.

(a) *Property Owners' Association.* (1) If the association has been formed as a legal entity, submit a copy of the articles of association, bylaws or similar documents, and a copy of the charter or certificate of incorporation.

(2) If the developer exercises any control over the association, state whether any contracts have been executed between the association and the developer or any affiliate or principal of the developer. If there have been, briefly summarize the terms of the contracts, their purpose, their duration and the method and rate of payment required by the contract. State whether the association may modify or terminate the contracts after the owners assume control of the association.

(3) State whether there is any agreement which would require the association to reimburse the developer, its affiliates or successors for any attorney's fees or costs arising from an action brought against them by the association or individual property owners regardless of the outcome of the action.

(4) If the answer to paragraph (a)(2) or (a)(3) of this section is in the affirmative, disclosure may be required in §1710.116(a) at the discretion of the Secretary.

(5) Submit a copy of any membership agreement or similar document.

(b) *Price range, type of sales and marketing.* (1) State the price range of lots in the subdivision.

(2) State the type of sales to be made, i.e., contract for deed, cash, deed with security instrument, etc.

(3) Describe the methods of advertising and marketing to be used for the subdivision. The description should include, but need not be limited to, information on such matters as to:

(i) Whether the developer will employ his own sales force or will contract with an outside group;

(ii) Whether wide area telephone solicitation will be employed;

(iii) Whether presentations will be made away from the immediate vicinity of the subdivision and/or if prospective purchasers will be furnished transportation from distant cities to the subdivision;

(iv) Whether mass mailing techniques will be used and gifts offered to those who respond.

(4) Submit a copy of any advertising or promotional material that is, or has been, used for the subdivision that:

(i) Mentions or refers to recreational facilities which are not disclosed in §1710.114, or;

(ii) Promotes the sale of lots based on the investment potential or expected profits, or;

(iii) Contains information which is in conflict with that disclosed in this Statement of Record.

Amendments to reflect changes in advertising or promotional material need be filed only when there is a material change related to one of the above factors. Depending upon the content of the material submitted, the Secretary may require additional warnings in the Property Report portion.

(c) *Violations and litigation.* (1) Submit a copy of the complaint(s), the answer(s) and the decision(s) for any litigation listed in §1710.116(c).

(2) If it is indicated in §1710.116(c) that the developer or any of the parties involved in the subdivision are, or have

been, the subject of any bankruptcy proceedings, furnish a copy of the schedules of liabilities and assets (or a recap of those schedules); the petition number; the date of the filing of the petition; names and addresses of the petitioners, trustee and counsel; the name and location of the court where the proceedings took place and the status or disposition of the petition.

Explain, briefly, the cause of the action.

(3) Furnish a copy of any orders issued in connection with any violations listed in §1710.116(c).

(d) *Resale or exchange program.* (1) If it is stated in §1710.116(d)(3) that there is an exchange program which provides sufficient lots to satisfy all requests for exchange, describe the method used to determine the number of lots required; state whether these lots have been reserved or set aside; whether additional lots will be provided if the lots available for exchange are exhausted and the source of any additional lots.

(e) *Unusual situations—(1) Foreign subdivisions.* If the subdivision is located outside the several States, the District of Columbia, the Commonwealth of Puerto Rico or the territories or possession of the United States, the Statement of Record shall be submitted in the English language and all supporting documents, including copies of any laws which restrict the ownership of land by aliens, shall be submitted in their original language and shall be accompanied by a translation into English.

§ 1710.219 Affirmation.

The following affirmation shall be executed by the senior executive officer or a duly authorized agent:

I hereby affirm that I am the Senior Executive Officer of the developer of the lots herein described or will be the Senior Executive Officer of the developer at the time lots are offered for sale or lease to the public, or that I am the agent authorized by the Senior Executive Officer of such developer to complete this statement (if agent, submit written authorization to act as agent); and,

That the statements contained in this Statement of Record and any supplement hereto, together with any documents submitted herein, are full, true, complete, and correct; and,

§ 1710.310

24 CFR Ch. X (4-1-11 Edition)

That the developer is bound to carry out the promises and obligations set forth in this Statement of Record and Property Report or I have clearly stated who is or will be responsible; and

That the fees accompanying this submission are in the amount required by the rules and regulations of the Office of Interstate Land Sales Registration.

(Date)

(Signature)

(Corporate seal if applicable)

(Title)

WARNING: Section 1418 of the Housing and Urban Development Act of 1968 (82 Stat. 598, 15 U.S.C. 1717) provides: "Any person who willfully violates any of the provisions of this title or of the rules and regulations or any person who willfully, in a Statement of Record filed under, or in a Property Report issued pursuant to this title, makes any untrue statement of a material fact * * *, shall upon conviction be fined not more than \$10,000.00 or imprisoned not more than 5 years, or both."

[45 FR 40490, June 13, 1980]

§ 1710.310 Annual report of activity.

(a) As an integral part of the Statement of Record, the developer shall file with the Secretary an Annual Report of Activity on any initial or consolidated registration not under suspension. For this purpose, only one Annual Report of Activity will be expected for subdivisions on which developers have filed consolidations. For registrations certified by a State as provided for in §1710.500, a developer need file only one Annual Report of Activity for any registration for which the OILSR number is the same (alphabetic designators indicate that the registration has been treated as a consolidation).

(b) The report shall be submitted within 30 days of the annual anniversary of the effective date of the initial Statement of Record.

(c) The report shall contain the following information:

- (1) Subdivision name and address.
- (2) Developer's name, address and telephone number.
- (3) Agent's name, address and telephone number.
- (4) Interstate Land Sales Registration number.

(5) The date on which the initial filing first became effective.

(6) The number of registered lots, parcels or units which are unsold as of the date on which the report is due.

(7) One of the following:

(i) A statement that the developer is still engaged in land sales activity at the subject subdivision and that there have been no changes in material fact since the last effective date was issued which would require an amendment to the Statement of Record; or

(ii) A statement that the developer is still engaged in land sales activity at the subject subdivision, that material changes have occurred since the last effective date, and that corrected pages to the Property Report portion or Additional Information and Documentation portion of the Statement accompany the report; or

(iii) A statement that the developer is no longer engaged in land sales activity at the subject subdivision, together with the reason the developer is no longer selling (e.g., all lots sold to the public or the remaining lots sold to another developer, along with the date of sale and the new developer's name, address and telephone number). A request may be made that the Statement of Record be voluntarily suspended. The request should be submitted in duplicate and will become effective upon the counter-signature of the Secretary (or an authorized Designee) with the duplicate being returned to the developer.

(8) The report shall be dated and shall be signed by the senior executive officer of the developer on a signature line above his typed name and title. The senior executive officer's acknowledgement shall be attested to or certified by a notary public or similar public official authorized to attest or certify acknowledgements in the jurisdiction in which the report is executed.

(d) If the report indicates that there are 101 or more registered lots, parcels or units remaining for sale, the report shall be accompanied by an amendment fee in the amount and form prescribed in §1710.35.

(e) Failure to submit the report when due shall be grounds for an action to

suspend the effective Statement of Record.

(Approved by the Office of Management and Budget under control number 2502-0243)

[49 FR 31373, Aug. 6, 1984]

Subpart C—Certification of Substantially Equivalent State Law

AUTHORITY: Sec. 1419, Interstate Land Sales Full Disclosure Act, 82 Stat. 590, 598; 15 U.S.C. 1718; sec. 7(d), Dept. of Housing and Urban Development Act, 42 U.S.C. 3535(d).

SOURCE: 45 FR 40491, June 13, 1980, unless otherwise noted.

§ 1710.500 General.

(a) This subpart establishes procedures and criteria for certifying State land sale or lease disclosure programs and State land development standards programs. The purpose of State Certification is to lessen the administrative burden on the individual developer, arising where there are duplicative state and federal registration and disclosure requirements, without affecting the level of protection given to the individual purchaser or lessee. If the Secretary determines that a state has adopted and is effectively administering a program that gives purchasers and lessees the same level of protection given to them by the Federal Interstate Land Sales Registration Program, then the Secretary shall certify that state. Developers who accomplish an effective registration with a state in which the land is located after the Secretary has certified the state may satisfy the registration requirements of the Secretary by filing with the Secretary materials designated by agreement with certified states in lieu of the federal Statement of Record and Property Report.

(b) A state that is certified by the Secretary shall be known as the situs certified state for all land located within its borders.

(c) After a developer is effectively registered with the Secretary through a certified state, the Secretary has the same authority over that developer as the Secretary has over developers who file directly with the Secretary. This includes the authority to subpoena information and to examine, evaluate

and suspend a developer's registration under sections 1407(d) and (e) of the Act and § 1710.45(b)(1) and (b)(2) of these regulations.

(d) The prohibitions against the use of the Property Report contained in § 1710.29 apply to state disclosure materials and substantive development standards. In addition, for purposes of this paragraph, references made to the Secretary, OILSR and the Department of Housing and Urban Development in § 1710.29 will include a reference to the equivalent state officer or agency.

(e) The Purchaser's Revocation Rights, Sales Practices and Standards rules contained in part 1715 of these regulations apply to developers who register with the Secretary through certified States. All of the rules in part 1715 apply, excepting the disclaimer statement in § 1715.50(a) which is modified to read as follows:

Obtain the Property Report or its equivalent, required by Federal and State law and read it before signing anything. No Federal or State agency has judged the merits or value, if any, of this property.

(f) Developers are obliged to pay filing fees as set forth in § 1710.35 of these regulations.

§ 1710.503 Notice of certification.

(a) If the Secretary determines that a state qualifies for certification under § 1710.501(a) or § 1710.501(b), the Secretary shall so notify the state in writing. The state will be effectively certified under the section and as of the date specified in the notice.

(b) If the Secretary determines that a state does not meet the standards for certification, the Secretary shall so notify the state in writing. The notice will specify particular changes in state law, regulations or administration that are needed to obtain certification. The Secretary shall not be bound in advance to certify a state that makes the suggested changes if other deficiencies become apparent at a later time.

(c) The Secretary's final determination to accept or reject a State's Application for Certification of Land Sales Program shall be published in the FEDERAL REGISTER.

(d) A state's certification will remain in effect until it is voluntarily suspended by the state or withdrawn by

§ 1710.504

the Secretary. A state can voluntarily suspend its certification by notifying the Secretary in writing. The suspension will take effect as of the date and time specified in the notice to the Secretary, or upon receipt by the Secretary if no date is specified. The Secretary may withdraw certification as provided in § 1710.505.

§ 1710.504 Cooperation among certified states and between certified states and the Secretary.

(a) By filing an Application for Certification of State Land Sales Program pursuant to § 1710.502, a state agrees that, if it is certified by the Secretary, it will:

(1) Accept for filing and allow to be distributed as the sole disclosure document, a disclosure document currently in effect in the situs certified state. Only those documents filed with the situs state after certification by the Secretary must automatically be accepted by other certified states;

(2) Certify copies of all disclosure documents, amendments and consolidations filed with it by developers of land located within its borders for and as needed by developers required to submit certified copies to the Secretary and all other certified states. The certification shall indicate whether the documents are currently in effect. The certification should state as follows:

The (indicate the State Department of Real Estate or other appropriate entity) has reviewed the attached materials and finds they are true copies of (1) the (indicate Property Report or other similar state accepted document or amendment to such document) for (indicate the name of the subdivision), made effective by the State of _____ on _____ (give date) and still in effect; and (2) the supporting documentation upon which such (indicate the document or amendment) is based.

Signature _____

(3) Assist and cooperate with the Secretary and other certified states by requiring that developers of land within its borders amend disclosure documents if any change occurs in any representation of material fact required to be stated in the disclosure documents, including a change resulting from the developer's compliance with the re-

quirements of the law in another certified state. The state shall require developers to send certified copies of the amended documents to the Secretary and requesting certified states. All amendments to such materials, which reflect changes in material facts regarding the subdivision, shall be submitted to the situs certified state authorities within 15 days of the date on which the developer knows, or should have known, of such change. Certified copies of the disclosure documents shall be submitted by the developer to the Secretary and the other certified states within 15 days after it becomes effective under the situs certified state laws.

(4) Continue to effectively operate its Land Sales Program as that Program is described in the Application for Certification and as it was certified by the Secretary.

(5) Assist and cooperate with the Secretary by monitoring the sales practices of developers registered with it directly or through another certified state, and by reporting to the Secretary any violations of the Act, including but not limited to the required contract provisions, revocation rights and anti-fraud provisions of 15 U.S.C. 1703, or the regulations.

(b) A state required to accept the disclosure documents of another situs certified state pursuant to paragraph (a)(1) of this section, may, in its discretion, require the developer to furnish it with copies certified pursuant to paragraph (a)(2) of this section.

(c) No state shall be prevented from establishing substantive or disclosure requirements which exceed the federal standard provided that such requirements are not in conflict with the Act or these regulations. For example, a certified state may impose additional disclosure requirements on developers of land located within its borders but may not impose additional disclosure requirements on developers whose disclosure documents it is required to accept pursuant to paragraph (a)(1) of this section. However, a certified state may impose additional nondisclosure requirements on out of state developers even though the developer is registered in the certified state in which the land is located.

(d) After a developer is effectively registered with a certified state through a situs certified state, either or both certified states may exercise full enforcement authorities and powers over that developer according to applicable law and regulations.

(e) The Secretary shall cooperate with the certified states by offering a forum for nonbinding arbitration of disputes between two or more certified States arising out of the State Certification Program.

§ 1710.505 Withdrawal of State certification.

(a) The Secretary shall periodically review the laws, regulations and administration thereof, of a certified state. If the Secretary finds that, taken as a whole, the laws, regulations or administration thereof, no longer meet the requirements of subpart C, then the Secretary may issue a notice to withdraw the certification of that state.

(b) The notice of proceedings to withdraw a state's certification will be issued to the state by the Secretary pursuant to §1720.236. The Secretary may, after notice and after an opportunity for a hearing, pursuant to §1720.237, issue an order withdrawing certification.

In the event that a withdrawal order is issued, the order shall remain in effect until the state has amended its laws, regulations or the administration thereof or has otherwise complied with the requirements of the order. When the state has complied with the requirements of the order, the Secretary shall so declare and the withdrawal order shall cease to be effective.

(c) Withdrawal orders issued pursuant to this subsection will be effective as of the date the order is received by the state. The withdrawal order shall be published in the FEDERAL REGISTER.

(d) The rules of chapter IX of 24 CFR part 1720, subpart D will generally apply to hearings on withdrawal of a state's certification.

§ 1710.506 State/Federal filing requirements.

(a)(1) If the Secretary has certified a state under §1710.501, the Secretary shall accept for filing disclosure mate-

rials or other acceptable documents which have been approved by the certified state within which the subdivision is located. Only those filings made by the developer with the state after the state was certified by the Secretary shall be automatically accepted by the Secretary.

(2) Retroactive application of the effectiveness of state's certification to a specified date may be granted on a state-by-state basis, where the Secretary determines that retroactive application will not result in automatic federal registration of any state filing that has not met the requirements of the certified state laws.

(b) For a developer to be registered with the Secretary, the developer shall file with the Secretary a state certified copy of the Property Report or its equivalent, and any other documentation as stipulated in the Secretary's Notice of Certification to the state.

(c) The documents and materials filed under paragraph (b) of this section will be automatically effective as the Federal Statement of Record and Property Report after these materials and the proper filing fee have been received by the Secretary.

(d) The Secretary has authority pursuant to §1710.45(b)(1) and (b)(2) to suspend individual filings which fail to meet the requirements of the certified state's law or regulations or the standards in the certification agreement whether or not the state agency has initiated a similar action.

(e)(1) State accepted materials filed with the Secretary pursuant to this section must be amended to reflect any amendment to such materials made effective by the state. All amendments to such materials must be submitted to the Secretary within 15 days after becoming effective under the applicable state laws. Amendments are automatically effective upon their receipt by the Secretary and the provisions of §1710.45(b)(1) and (2) apply to amendments filed under this section.

(2) Amendments shall include or be accompanied by:

(i) A letter from the developer giving a narrative statement fully explaining the purpose and significance of the

§ 1710.507

amendment and referring to that section and page of the material which is being amended, and;

(ii) A signed state acceptance certification substantially the same as that required by § 1710.504(a)(2).

(f) If a certified state suspends the registration of a particular subdivision for any reason, the subdivision's federal registration with the Secretary shall be automatically suspended as a result of the state action. No action need be taken by the Secretary to effect the suspension.

(g) A state is certified only with regard to land located within the state borders. The Secretary is not required to accept filings which have been accepted by a certified state if the land which is the subject of the filing is not located within that certified state. For example, if State A is certified by the Secretary and State B is not, the Secretary is not required to accept filings from State B simply because State A accepts filings from State B.

§ 1710.507 Effect of suspension or withdrawal of certification granted under § 1710.501(a): Full disclosure requirement.

(a) If a state certified under § 1710.501(a) suspends its own certification or has its certification withdrawn under § 1710.505, the Federal disclosure materials accepted and made effective by the Secretary, pursuant to § 1710.506, prior to the suspension or withdrawal shall remain in effect unless otherwise suspended by the Secretary.

(b) In the event that there is a change in a material fact with regard to a subdivision that remains registered under the provisions of paragraph (a), the developer shall file a new registration with the Secretary meeting the requirements of the then applicable Federal registration regulations. Modifications of the Federal format may be used as specified by the Secretary.

§ 1710.508 Effect of suspension of certification granted under § 1710.501(b): Sufficient protection requirement.

(a) If a state certified under § 1710.501(b) suspends its own certification or has its certification with-

24 CFR Ch. X (4-1-11 Edition)

drawn under § 1710.505, the effectiveness of the Federal disclosure materials accepted and made effective by the Secretary, pursuant to § 1710.506, prior to the suspension or withdrawal shall terminate ninety (90) days after the notice of withdrawal order is published in the FEDERAL REGISTER as provided in § 1710.505(c).

(b) At the end of the ninety day period, or during the ninety day period in the event that there is a change in material fact with regard to a subdivision that remains registered under the provisions of paragraph (a), the developer shall file a new registration with the Secretary meeting the requirements of the then applicable Federal registration regulations. Modifications of the Federal format may be used as specified by the Secretary.

§ 1710.552 Previously accepted state filings.

(a) Materials filed with a state and accepted by the Secretary as a Statement of Record prior to January 1, 1981, pursuant to 24 CFR 1710.52-59 (as published in the FEDERAL REGISTER on April 10, 1979) may continue in effect. However, developers must comply with the applicable amendments to the Federal Act and the regulations thereunder. In particular, see §§ 1710.558 and 1710.559, which require that the Property Report and contracts or agreements contain notice of purchaser's revocation rights. In addition see § 1715.15(f), which provides that it is unlawful to make any representations with regard to the developer's obligation to provide or complete roads, water, sewers, gas, electrical facilities or recreational amenities, unless the developer is obligated to do so in the contract.

(b) If any such filing becomes inactive or suspended under the laws of the state, the registration with the Secretary shall be ineffective from that time.

(c) Such Statement of Record may be suspended pursuant to § 1710.45.

(d) The Secretary may refuse to accept any particular filing under this section when it is determined that acceptance is not in the public interest.

(e) The Secretary may require such changes, additional information, documents or certification as the Secretary determines to be reasonably necessary or appropriate in the public interest.

§ 1710.556 Previously accepted state filings—amendments and consolidations.

(a) *Amendments*—(1) *General requirements.* State accepted materials, filed with the Secretary pursuant to § 1710.552 shall be amended to reflect any amendment to such materials made effective by the state or any change of a material fact regarding the subdivision. All amendments to such materials, which reflect changes in material facts regarding the subdivision, shall be submitted to the state authorities within 15 days of the date on which the developer knows, or should have known, of such change and to the Secretary within 15 days after it becomes effective under the applicable State laws. However, such amendment shall not be effective as a Federal registration until the Secretary has determined that the amendment meets all applicable requirements of these regulations.

(2) Amendments shall include or be accompanied by:

(i) A letter from the developer giving a narrative statement fully explaining the purpose and significance of the amendment and referring to that section and page of the Statement of Record which is being amended, and;

(ii) All amended pages of the state accepted materials filed with the Secretary. These pages shall be retyped with their amendments. Each such page shall have its date of preparation in the lower right hand corner, and;

(iii) A signed state acceptance certification, and;

(iv) The appropriate fees as indicated in § 1710.35.

(b) *Consolidations*—(1) *When consolidations allowed.* If lots are to be registered pursuant to § 1710.552 which are in the same common promotional plan with other lots already registered with the Secretary, then new consolidated state accepted materials including such lots may be filed with the Secretary as a Statement of Record following the format of the previously accepted filing.

(2) Consolidated Statements of Record shall include or be accompanied by:

(i) State accepted consolidation materials which are also acceptable to the Secretary as a Statement of Record (state property report inclusive). These state accepted consolidation materials shall cover all lots previously registered in the common promotional plan except those deleted pursuant to other provisions in these regulations. These materials shall also include information and items required for state accepted materials filed as an initial registration Statement of Record, except that, supporting documentation in materials previously made effective by the Secretary for other lots in the subject common promotional plan may be incorporated by reference into the new consolidation materials submitted as a Statement of Record. However, such documentation may be incorporated by reference only if it is applicable to the new consolidated lots as well as to the previously registered lots.

(ii) A signed state acceptance certification.

(iii) The appropriate fees as indicated in § 1710.35.

(c) *Effective date—State filing.* The effective dates of state materials filed as amendments and consolidated Statements of Record shall be determined in accordance with the provisions of § 1710.21.

[45 FR 40491, June 13, 1980, as amended at 49 FR 31372, Aug. 6, 1984]

§ 1710.558 Previously accepted state filings—notice of revocation rights on property report cover page.

(a)(1) The cover page on Property Reports for filings made with the Secretary pursuant to § 1710.552 shall be prepared in accordance with § 1710.105 and shall include the following paragraphs:

“If you received this Report prior to signing a contract or agreement, you may cancel your contract or agreement by giving notice to the seller anytime before midnight of the seventh day following the signing of the contract or agreement.

“If you did not receive this Report before you signed a contract or agreement, you may cancel the contract or agreement anytime within two years from the date of signing.”

§ 1710.559

(2) If the purchaser is entitled to a longer revocation period by operation of State law, that period becomes the Federal revocation period and the Cover Page must reflect the longer period, rather than the seven days.

(b)(1) If a deed is not delivered within 180 days of the signing of the contract or agreement of sale or unless certain provisions are included in the contract or agreement, the purchaser is entitled to cancel the contract within two years from the date of signing the contract or agreement.

(2) The deed must be a warranty deed, or where such a deed is not commonly used, a similar deed legally acceptable in the jurisdiction where the lot is located. The deed must be free and clear of liens and encumbrances.

(3) The contract provisions are:

(i) A legally sufficient and recordable lot description, and;

(ii) A provision that the seller will give the purchaser written notification of purchaser's default or breach of contract and the opportunity to remedy the default or breach within 20 days of the notice; and

(iii) A provision that, if the purchaser loses rights and interest in the lot because of the purchaser's default or breach of contract after 15 percent of the purchase price, exclusive of interest, has been paid, the seller shall refund to the purchaser any amount which remains from the payments made after subtracting 15 percent of the purchase price, exclusive of interest, or the amount of the seller's actual damages, whichever is the greater.

(4) If a deed is not delivered within 180 days of the signing of the contract or if the necessary provisions are not included in the contract, the following statement shall be used in place of any other rescission language:

"Under Federal law you may cancel your contract or agreement of sale any time within two years from the date of signing."

§ 1710.559 Previously accepted state filings—notice of revocation rights in contracts and agreements.

(a)(1) All contracts or agreements, including promissory notes used in sale of lots for filings made with the Secretary pursuant to § 1710.552, must contain the following language in boldface

24 CFR Ch. X (4-1-11 Edition)

type (which must be distinguished from the type used for the rest of the contract) on the face or signature page above all signatures:

You have the option to cancel your contract or agreement of sale by notice to the seller until midnight of the seventh day following the signing of the contract or agreement.

If you did not receive a Property Report prepared pursuant to the rules and regulations of the Office of Interstate Land Sales Registration, U.S. Department of Housing and Urban Development, in advance of your signing the contract or agreement, this contract or agreement may be revoked at your option for two years from the date of signing.

(2) If the purchaser is entitled to a longer revocation period by operation of State law or the Act, that period becomes the Federal revocation period and the contract or agreement must reflect the longer period, rather than the seven days. The language shall be consistent with that shown on the Cover Page (see § 1710.558).

(b) The above revocation provisions may not be limited or qualified in the contract or other document by requiring a specific type of notice or by requiring that notice be given at a specified place.

PART 1715—PURCHASERS' REVOCATION RIGHTS, SALES PRACTICES AND STANDARDS

Subpart A—Purchasers' Revocation Rights

Sec.

1715.1 General.

1715.2 Revocation regardless of registration.

1715.4 Contract requirements and revocation.

1715.5 Reimbursement.

Subpart B—Sales Practices and Standards

1715.10 General.

1715.15 Unlawful sales practices—statutory provisions.

1715.20 Unlawful sales practices—regulatory provisions.

1715.25 Misleading sales practices.

1715.27 Fair housing.

1715.30 Persons to whom subpart B is inapplicable.

Subpart C—Advertising Disclaimers

1715.50 Advertising disclaimers; subdivisions registered and effective with HUD.

Office of Asst. Sec. for Housing, HUD

§ 1715.15

AUTHORITY: 15 U.S.C. 1718; 42 U.S.C. 3535(d).
SOURCE: 45 FR 40496, June 13, 1980, unless otherwise noted.

**Subpart A—Purchasers’
Revocation Rights**

§ 1715.1 General.

The purpose of this subpart A is to elaborate on the revocation rights in 15 U.S.C. 1703, by enumerating certain conditions under which purchasers may exercise revocation rights. Generally, whenever revocation rights are available, they apply to promissory notes, as well as traditional agreements.

[61 FR 13597, Mar. 27, 1996]

§ 1715.2 Revocation regardless of registration.

All purchasers have the option to revoke a contract or lease with regard to a lot not exempt under §§ 1710.5 through 1710.11 and 1710.14 until midnight of the seventh day after the day that the purchaser signs a contract or lease. If a purchaser is entitled to a longer revocation period under State law, that period is deemed the Federal revocation period rather than the 7 days, and all contracts and agreements (including promissory notes) shall so state.

[61 FR 13597, Mar. 27, 1996]

§ 1715.4 Contract requirements and revocation.

(a) In accordance with 15 U.S.C. 1703(d)(3), the refund to the purchaser is calculated by subtracting from the amount described in 15 U.S.C. 1703(d)(3)(B), the greater of:

(1) Fifteen percent of the purchase or lease price of the lot (excluding interest owed) at the time of the default or breach of contract or agreement; or

(2) The amount of damages incurred by the seller or lessor due to the default or breach of contract.

(b) For the purposes of this section:

Damages incurred by the seller or lessor means actual damages resulting from the default or breach, as determined by the law of the jurisdiction governing the contract. However, no damages may be specified in the contract or agreement, except a liquidated damages clause not exceeding 15 percent of

the purchase price of the lot, excluding any interest owed.

Purchase price means the cash sales price of the lot shown on the contract.

(c) The contractual requirements of 15 U.S.C. 1703(d) do not apply to the sale of a lot for which, within 180 days after the signing of the sales contract, the purchaser receives a warranty deed or, where warranty deeds are not commonly used, its equivalent under State law.

[61 FR 13598, Mar. 27, 1996]

§ 1715.5 Reimbursement.

If a purchaser exercises rights under 15 U.S.C. 1703(b), (c) or (d), but cannot reconvey the lot in substantially similar condition, the developer may subtract from the amount paid by the purchaser, and otherwise due to the purchaser under 15 U.S.C. 1703, any diminished value in the lot caused by the acts of the purchaser.

[61 FR 13598, Mar. 27, 1996]

Subpart B—Sales Practices and Standards

§ 1715.10 General.

Sales practices means any conduct or advertising by a developer or its agents to induce a person to buy or lease a lot. This subpart describes certain unlawful sales practices and provides standards to illustrate what other sales practices are considered misleading in light of certain circumstances in which they are made and within the context of the overall offer and sale or lease.

§ 1715.15 Unlawful sales practices—statutory provisions.

The statutory prohibitions against fraudulent or misleading sales practices are set forth at 15 U.S.C. 1703(a). With respect to the prohibitions against representing that certain facilities will be provided or completed unless there is a contractual obligation to do so by the developer:

(a) The contractual covenant to provide or complete the services or amenities may be conditioned only upon grounds that are legally sufficient to establish impossibility of performance in the jurisdiction where the services

§ 1715.20

or amenities are being provided or completed;

(b) Contingencies such as acts of God, strikes, or material shortages are recognized as permissible to defer completion of services or amenities; and

(c) In creating these contractual obligations developers have the option of incorporating by reference the Property Report in effect at the time of the sale or lease. If a developer chooses to incorporate the Property Report by reference, the effective date of the Property Report being incorporated by reference must be specified in the contract of sale or lease.

[61 FR 13598, Mar. 27, 1996]

§ 1715.20 Unlawful sales practices—regulatory provisions.

In selling, leasing or offering to sell or lease any lot in a subdivision it is an unlawful sales practice for any developer or agent, directly or indirectly, to:

(a) Give the Property Report to a purchaser along with other materials when done in such a manner so as to conceal the Property Report from the purchaser.

(b) Give a contract to a purchaser or encourage him to sign anything before delivery of the Property Report.

(c) Refer to the Property Report or Offering Statement as anything other than a Property Report or Offering Statement.

(d) Use any misleading practice, device or representation which would deny a purchaser any cancellation or refund rights or privileges granted the purchaser by the terms of a contract or any other document used by the developer as a sales inducement.

(e) Refuse to deliver a Property Report to any person who exhibits an interest in buying or leasing a lot in the subdivision and requests a copy of the Property Report.

(f) Use a Property Report, note, contract, deed or other document prepared in a language other than that in which the sales campaign is conducted, unless an accurate translation is attached to the document.

(g) Deliberately fail to maintain a sufficient supply of restrictive covenants and financial statements or to deliver a copy to a purchaser upon re-

24 CFR Ch. X (4–1–11 Edition)

quest as required by §§ 1710.109(f), 1710.112(d), 1710.209(g) and 1710.212(i).

(h) Use, as a sales inducement, any representation that any lot has good investment potential or will increase in value unless it can be established, in writing, that:

(1) Comparable lots or parcels in the subdivision have, in fact, been resold by their owners on the open market at a profit, or;

(2) There is a factual basis for the represented future increase in value and the factual basis is certain, and;

(3) The sales price of the offered lot does not already reflect the anticipated increase in value due to any promised facilities or amenities. The burden of establishing the relevancy of any comparable sales and the certainty of the factual basis of the increase in value shall rest upon the developer.

(i) Represent a lot as a homesite or building lot unless:

(1) Potable water is available at a reasonable cost;

(2) The lot is suitable for a septic tank operation or there is reasonable assurance that the lot can be served by a central sewage system;

(3) The lot is legally accessible; and

(4) The lot is free from periodic flooding.

§ 1715.25 Misleading sales practices.

Generally, promotional statements or material will be judged on the basis of the affirmative representations contained therein and the reasonable inferences to be drawn therefrom, unless the contrary is affirmatively stated or appears in promotional material, or unless adequate safeguards have been provided by the seller to reasonably guarantee the occurrence of the thing inferred. For example, when a lot is represented as being sold by a warranty deed, the inference is that the seller can and will convey fee simple title free and clear of all liens, encumbrances, and defects except those which are disclosed in writing to the prospective purchaser prior to conveyance. The following advertising and promotional practices, while not all inclusive, are considered misleading, and are used to evaluate a developer's or agent's representations in determining

possible violations of the Act or regulations. (In this section “represent” carries its common meaning.)

(a) *Proposed improvements.* References to proposed improvements of any land unless it is clearly indicated that (1) the improvements are only proposed or (2) what the completion date is for the proposed improvement.

(b) *Off-premises representations.* Representing scenes or proposed improvements other than those in the subdivision unless

(1) It is clearly stated that the scenes or improvements are not related to the subdivision offered; or

(2) In the case of drawings that the scenes or improvements are artists’ renderings;

(3) If the areas or improvements shown are available to purchasers, what the distance in road miles is to the scenes or improvements represented.

(c) *Land use representations.* Representing uses to which the offered land can be put unless the land can be put to such use without unreasonable cost to the purchaser and unless no fact or circumstance exists which would prohibit the immediate use of the land for its represented use.

(d) *Use of “road” and “street”.* Using the words “road” or “street” unless the type of road surface is disclosed. (All roads and streets shown on subdivision maps are presumed to be of an all-weather graded gravel quality or higher and are presumed to be traversable by conventional automobile under all normal weather conditions unless otherwise shown on the map.)

(e) *Road access and use.* Representing the existence of a road easement or right-of-way unless the easement or right-of-way is dedicated to the public, to property owners or to the appropriate property owners association.

(f) *Waterfront property.* References to waterfront property, unless the property being offered actually fronts on a body of water. Representations which refer to “canal” or “canals” must state the specific use to which such canal or canals can be put.

(g) *Maps and distances.* (1) The use of maps to show proximity to other communities, unless the maps are drawn to scale and scale included, or the specific

road mileage appears in easily readable print.

(2) The use of the terms such as “minutes away”, “short distance”, “only miles”, or “near” or similar terms to indicate distance unless the actual distance in road miles is used in conjunction with such terms. Road miles will be measured from the approximate geographical center of the subdivided lands to the approximate downtown or geographical center of the community.

(h) *Lot size.* Representation of the size of a lot offered unless the lot size represented is exclusive of all easements to which the lot may be subject, except for those for providing utilities to the lot.

(i) *“Free” lots.* Representing lots as “free” if the prospective purchaser is required to give any consideration whatsoever, offering lots for “closing costs only” when the closing costs are substantially more than customary, or when an additional lot must be purchased at a higher price.

(j) *Pre-development prices.* References to pre-development sales at a lower price because the land has not yet been developed unless there are plans for development, and reasonable assurance is available that the plans will be completed.

(k) *False reports of lot sales.* Repeatedly announcing that lots are being sold or to make repetitive announcements of the same lot being sold when in fact this is not the case.

(l) *Guaranteed refund.* Use of the word “guarantee” or phrase “guaranteed refund” or similar language implying a money-back guarantee unless the refund is unconditional.

(m) *Discount certificates.* The use of discount certificates when in fact there is no actual price reduction or when a discount certificate is regularly used.

(n) *Lot exchanges.* Representations regarding property exchange privileges unless any applicable conditions are clearly stated.

(o) *Resale program.* Making any representation that implies that the developer or agent will resell or repurchase the property being offered at some future time unless the developer or agent has an ongoing program for doing so.

§ 1715.27

(p) *Symbols for conditions.* The use of asterisks or any other reference symbol or oral parenthetical expression as a means of contradicting or substantially changing any previously made statement or as a means of obscuring material facts.

(q) *Proposed public facilities.* References to a proposed public facility unless money has been budgeted for construction of the facility and is available to the public authority having the responsibility of construction, or unless disclosure of the existing facts concerning the public facility is made.

(r) *Non-profit or institutional name use.* The use of names or trade styles which imply that the developer is a nonprofit research organization, public bureau, group, etc., when such is not the case.

§ 1715.27 Fair housing.

Title VIII of the Civil Rights Act of 1968, 42 U.S.C. 3601, *et seq.*, and its implementing regulations and guidelines apply to land sales transactions to the extent warranted by the facts of the transaction.

[61 FR 13598, Mar. 27, 1996]

§ 1715.30 Persons to whom subpart B is inapplicable.

Newspaper or periodical publishers, job printers, broadcasters, or telecasters, or any of the employees thereof, are not subject to this subpart unless the publishers, printers, broadcasters, or telecasters—

- (a) Have actual knowledge of the falsity of the advertisement or
- (b) Have any interest in the subdivision advertised or
- (c) Also serve directly or indirectly as the advertising agent or agency for the developer.

Subpart C—Advertising Disclaimers

§ 1715.50 Advertising disclaimers; subdivisions registered and effective with HUD.

(a) The following disclaimer statement shall be displayed below the text of all printed material and literature used in connection with the sale or lease of lots in a subdivision for which

24 CFR Ch. X (4–1–11 Edition)

an effective Statement or Record is on file with the Secretary. If the material or literature consists of more than one page, it shall appear at the bottom of the front page. The disclaimer statement shall be set in type of at least ten point font.

Obtain the Property Report required by Federal law and read it before signing anything. No Federal agency has judged the merits or value, if any, of this property.

(b) If the advertising is of a classified type; is not more than five inches long and not more than one column in print wide, the disclaimer statement may be set in type of at least six point font.

(c) This disclaimer statement need not appear on billboards, on normal size matchbook folders or business cards which are used in advertising nor in advertising of a classified type which is less than one column in print wide and is less than five inches long.

(d) A developer who is required by any state, or states, to display an advertising disclaimer in the same location, or one of equal prominence, as that of the federal disclaimer, may combine the wording of the disclaimers. All of the wording of the federal disclaimer must be included in the resulting combined disclaimer.

PART 1720—FORMAL PROCEDURES AND RULES OF PRACTICE

Subpart A—Rules and Rulemaking

- Sec.
- 1720.1 Scope of rules in this subpart.
- 1720.5 Initiation of rulemaking.
- 1720.10 Investigations and conferences.
- 1720.15 Notice.
- 1720.20 Promulgation of rules and regulations.
- 1720.25 Effective date of rules and regulations.

Subpart B—Filing Assistance

- 1720.30 Scope of this subpart.
- 1720.35 Prefiling assistance.
- 1720.40 Processing of filings.

Subpart C [Reserved]

Subpart D—Adjudicatory Proceedings

GENERAL PROVISIONS

- 1720.105 Scope of rules in this subpart.

Office of Asst. Sec. for Housing, HUD

§ 1720.5

- 1720.110 Applicability of sections of this subpart.
- 1720.115 Department representative.
- 1720.120 Qualification for appearances.
- 1720.125 Public nature and timing of hearings.
- 1720.130 Restrictions on appearances as to former officers and employees.
- 1720.135 Standards of practice.
- 1720.140 Administrative law judge, powers and duties.
- 1720.145 Disqualification of administrative law judge.
- 1720.150 Failure to comply with administrative law judge's directions.
- 1720.155 Ex parte communications.
- 1720.160 Form and filing requirements.
- 1720.165 Time computation.
- 1720.170 Service.
- 1720.175 Intervention by interested persons.
- 1720.180 Settlements.

PLEADINGS

- 1720.205 Suspension notice under §1710.45(a) of this chapter.
- 1720.210 Hearings—suspension notice pursuant to §1710.45(a) of this chapter.
- 1720.215 Notice of proceedings pursuant to §1710.45(b)(1) of this chapter.
- 1720.220 Hearings—notice of proceedings pursuant to §1710.45(b)(1) of this chapter.
- 1720.225 Suspension order under §1710.45(b)(2) of this chapter.
- 1720.230 Suspension order under §1710.45(b)(3) of this chapter.
- 1720.235 Hearings—suspension orders issued pursuant to §§1710.45(b)(2) and 1710.45(b)(3) of this chapter.
- 1720.236 Notice of proceedings to withdraw a State's certification pursuant to §1710.505 of this chapter.
- 1720.237 Hearings—notice of proceedings pursuant to §1710.505 of this chapter.
- 1720.238 Notices of proceedings to terminate exemptions pursuant to §§1710.14, 1710.15 and 1710.16 of this chapter.
- 1720.239 Hearings—notice of proceedings pursuant to §§1710.14, 1710.15 and 1710.16 of this chapter.
- 1720.240 Time for filing answer.
- 1720.245 Content of answer.
- 1720.250 Presumption of hearing request.
- 1720.255 Amendments and supplemental pleadings.
- 1720.260 Prehearing conferences.
- 1720.265 Reporting—prehearing conferences.

MOTIONS

- 1720.305 Motions—filing requirements.
- 1720.310 Answers to motions.
- 1720.315 Motions for more definite statement.
- 1720.320 Motions for extension of time.
- 1720.325 Motions for dismissal.
- 1720.330 Motions to limit or quash.
- 1720.335 Consolidation.

DISCOVERY AND EVIDENCE

- 1720.405 Depositions and discovery.
- 1720.410 Subpoenas ad testificandum.
- 1720.415 Subpoenas duces tecum.
- 1720.420 Rulings on applications for compulsory process; appeals.
- 1720.425 Presentation and admission of evidence.
- 1720.430 Production of witnesses' statements.
- 1720.435 Official notice.

HEARINGS

- 1720.505 Interlocutory review of administrative law judge's decision.
- 1720.510 Reporting and transcription.
- 1720.515 Corrections.
- 1720.520 Proposed findings, conclusions, and order.
- 1720.525 Decision of administrative law judge.
- 1720.530 Decision of administrative law judge—content.
- 1720.535 Reopening of proceeding; termination of jurisdiction.

APPEALS

- 1720.605 Appeal from decision of administrative law judge.
- 1720.610 Answering brief.
- 1720.615 Reply brief.
- 1720.620 Length and form of briefs.
- 1720.625 Oral argument.
- 1720.630 Decision on appeal or review.
- 1720.635 Appeals officer.

AUTHORITY: 15 U.S.C. 1718; 42 U.S.C. 3535(d).

SOURCE: 43 FR 29496, July 7, 1978, unless otherwise noted.

Subpart A—Rules and Rulemaking

§ 1720.1 Scope of rules in this subpart.

The rules in this subpart apply to and govern procedures for the promulgation of rules and regulations under the Act. The rules in this subpart do not apply to interpretative rules, general statements of policy, rules of organization procedure or practice or in any situation in which the Secretary for good cause finds (and incorporates the findings and brief statement of the reasons therefor in the rules issued) that notice and public procedure thereon are impracticable, unnecessary or contrary to the public interest.

§ 1720.5 Initiation of rulemaking.

(a) The issuance, amendment or repeal of any rule or regulation may be

§ 1720.10

proposed upon the initiative of the Secretary or upon the petition of any interested person showing reasonable grounds therefor.

(b) Petitions for rulemaking by interested persons filed under this section:

(1) Shall be identified as a petition for rulemaking under this subpart;

(2) Shall explain the interest of the petitioner in the action requested;

(3) Shall set forth the text or substance of the rule or amendment proposed or specify the rule that the petitioner seeks to have repealed, as the case may be;

(4) Shall contain any information and arguments available to the petitioner to support the action sought; and

(5) Shall be filed with the Rules Docket Clerk, Office of General Counsel, Department of Housing and Urban Development, Room 5218, 451 Seventh Street SW., Washington, DC 20410.

(c) The Secretary shall respond to a petition submitted under this section within 180 days of receipt thereof, except that this time limit may be exceeded for good cause found and communicated to the petitioner. The Secretary's normal response shall be to grant or deny the petition but alternatively, the Secretary may schedule a public hearing or other appropriate proceeding prior to the granting or denial of a petition. If the Secretary grants the petition, the Secretary shall publish a proposed rule in accordance with the petition and a copy of the proposed rule shall be furnished to the petitioner. If the Secretary denies the petition, the Secretary shall notify the petitioner within 7 days after such denial.

§ 1720.10 Investigations and conferences.

(a) In connection with a rulemaking proceeding, the Secretary may conduct such investigations, make such studies, and hold such conferences as are necessary. Investigations in connection with a rulemaking may be conducted in accordance with the general investigatory procedures under part 3800 of this chapter.

(b) At any such conferences, interested persons may appear to express

24 CFR Ch. X (4-1-11 Edition)

views and suggest amendments relative to proposed rules.

[61 FR 10442, Mar. 13, 1996]

§ 1720.15 Notice.

General notice of proposed rulemaking shall be published in the FEDERAL REGISTER and, to the extent practicable, otherwise made available to interested persons. Such notice shall state the time, place, and nature of public hearings, if any; the authority under which the rule or regulation is proposed; either the terms or substance of the proposed rule or regulation or a description of the subjects and issues involved; and the manner in which interested persons shall be afforded the opportunity to participate in the rulemaking. If the rulemaking was instituted pursuant to petition, a copy of the notice shall be served on the petitioner.

§ 1720.20 Promulgation of rules and regulations.

The Secretary, after consideration of all relevant matters of fact, law, policy, and discretion, including all relevant matters presented by interested persons in the rulemaking proceedings, shall adopt and publish in the FEDERAL REGISTER an appropriate rule or regulation together with a concise general statement of its basis and purpose and any necessary findings; or the Secretary shall give other appropriate public notice of disposition of the rulemaking proceeding.

§ 1720.25 Effective date of rules and regulations.

The effective date of any rule or regulation or of an amendment, suspension, or repeal of any rule or regulation shall be specified in a notice published in the FEDERAL REGISTER. Such date shall not be less than 30 days after the date of such publication unless the Secretary specifies an earlier effective date for good cause found and published with the rule or regulation.

Subpart B—Filing Assistance

Subpart C [Reserved]

§ 1720.30 Scope of this subpart.

The rules in this subpart apply to and govern procedures under which developers may obtain prefiling assistance and be notified of and permitted to correct deficiencies in the Statement of Record.

§ 1720.35 Prefiling assistance.

Persons intending to file with the Office of Interstate Land Sales Registration may receive advice of a general nature as to the preparation of the filing including information as to proper format to be used and the scope of the items to be included in the format. Inquiries and requests for informal discussions with staff members should be directed to the Administrator, Office of Interstate Land Sales Registration, Department of Housing and Urban Development, 451 Seventh Street SW., Washington, DC 20410.

§ 1720.40 Processing of filings.

(a) Statements of Record and accompanying filing fees will be received on behalf of the Secretary by the Administrator, Office of Interstate Land Sales Registration, for determination of:

- (1) Completeness of the statement,
- (2) Adequacy of the filing fee and
- (3) Adequacy of disclosure.

Where it appears that all three criteria are satisfied and it is otherwise practicable, acceleration of the effectiveness of the Statement of Record will normally be granted.

(b) Filings intended as Statements of Record but which do not comply in form with §§1710.105 and 1710.120 of this chapter, whichever is applicable, and Statements of Record accompanied by inadequate filing fees will not be effective to accomplish any purpose under the Act. At the discretion of the Administrator, such filings and any moneys accompanying them may be immediately returned to the sender or after notification may be held pending the sender's appropriate response.

(c) Persons filing incomplete or inaccurate Statements of Record will be notified of the deficiencies therein by the Suspension Notice procedure described in §1710.45(a) of this chapter.

Subpart D—Adjudicatory Proceedings

GENERAL PROVISIONS

§ 1720.105 Scope of rules in this subpart.

The rules in this subpart are applicable to adjudicative proceedings which involve a hearing or opportunity for a hearing under the Interstate Land Sales Full Disclosure Act.

§ 1720.110 Applicability of sections of this subpart.

Succeeding sections of this subpart shall apply to all adjudicatory hearings conducted by OILSR unless specifically limited in applicability by a particular section.

§ 1720.115 Department representative.

In each case heard before an administrative law judge pursuant to this part, the Department shall be represented by a Department hearing attorney. The General Counsel shall designate one or more attorneys to act as Department hearing attorneys.

§ 1720.120 Qualification for appearances.

(a) Members of the bar of a Federal Court or of the highest court of any state or of the United States are eligible to practice before the Secretary. No register of attorneys will be maintained.

(b) Any individual or member of a partnership involved in any proceeding or investigation may appear on personal behalf or that of the partnership upon adequate identification. A corporation or association may be represented by a bona fide officer thereof upon a showing of adequate authorization.

(c) A person shall not be represented except as stated in paragraphs (a) and (b) of this section unless otherwise permitted.

§ 1720.125 Public nature and timing of hearings.

(a) All hearings in adjudicative proceedings shall be public.

§ 1720.130

24 CFR Ch. X (4-1-11 Edition)

(b) Hearings shall proceed with all reasonable speed and insofar as practicable, shall be held at one place and shall continue without recess or suspension until concluded. The administrative law judge shall have the authority to order brief intervals of the sort normally involved in judicial proceedings and, in unusual and exceptional circumstances for good cause stated on the record, shall have the authority to order hearings at more than one place and to order recesses to permit further gathering of evidence or settlement discussions.

§ 1720.130 Restrictions on appearances as to former officers and employees.

(a) Except as specifically authorized by the Secretary, no former officer or employee of the Department of Housing and Urban Development shall appear as attorney or counsel or otherwise participate through any form of professional consultation or assistance in any proceeding or investigation, formal or informal, which was pending in any manner in the Office of Interstate Land Sales Registration while such former officer or employee served with the Department of Housing and Urban Development.

(b) In cases to which paragraph (a) of this section is applicable, a former officer or employee of the Department of Housing and Urban Development may request authorization to appear or participate in a proceeding or investigation by filing with the Secretary a written application disclosing the following relevant information:

(1) The nature and extent of the former officer's or employee's participation in, knowledge of, and connection with the proceeding or investigation during service with the Department of Housing and Urban Development;

(2) Whether the files of the proceeding or investigation came to the former officer or employee's attention;

(3) Whether the former officer or employee was employed in the same office, division, or administrative unit in which the proceeding or investigation is or has been pending;

(4) Whether the former officer or employee worked directly or in close association with the Office of Interstate

Land Sales Registration personnel assigned to the proceeding or investigation;

(5) Whether during service with the Department of Housing and Urban Development the former officer or employee was engaged in any matter concerning the individual, company or industry in the proceeding or investigation.

(c) The requested authorization will not be given in any case:

(1) Where it appears that the former officer or employee during service with the Department of Housing and Urban Development participated personally and substantially in the proceeding or investigation, or

(2) Where the application is filed within one (1) year after termination of the former officer's or employee's service with the Department of Housing and Urban Development and it appears that within a period of one (1) year prior to the termination of service the proceeding or investigation was within the official responsibility of the former officer or employee.

In other cases, authorization will be given where the Secretary is satisfied that the appearance or participation will not involve any actual conflict of interest or impropriety thereof.

(d) In any case in which a former officer or employee of the Department of Housing and Urban Development is prohibited under this section from appearing or participating in a proceeding or investigation, any partner or legal or business associate of such former officer or employee shall likewise be so prohibited unless:

(1) Such partner or legal or business associate files with the Secretary an affidavit that in connection with the matter the services of the disqualified former officer or employee will not be utilized in any respect and the matter will not be discussed with the former officer or employee in any manner, and that the disqualified former officer or employee shall not share, directly or indirectly, in any fees or retainers received for services rendered in connection with such proceeding or investigation;

(2) The disqualified former officer or employee files an affidavit agreeing not to participate in the matter in any

manner, and not to discuss it with any person involved in the matter; and

(3) Upon the basis of such affidavits, the Secretary determines that the appearance or participation by the partner or associate would not involve any actual conflict of interest or impropriety thereof.

§ 1720.135 Standards of practice.

(a) Attorneys shall conform to the standards of professional and ethical conduct required by practitioners in the courts of the United States and by the bars of which the attorneys are members.

(b) The privilege of appearing or practicing may be denied, temporarily or permanently, to any person who is found after notice and opportunity for hearing which at the person's request or in the discretion of the Secretary may be private, and for presentation of oral argument in the matter:

(1) Not to possess the requisite qualifications to represent others, or

(2) To be lacking in character or integrity, or

(3) To have engaged in unethical or improper professional conduct.

(c) Contemptuous conduct at any hearing shall be grounds for summary exclusion from said hearing for the duration of the hearing.

§ 1720.140 Administrative law judge, powers and duties.

(a) Hearings in adjudicative proceedings shall be presided over by a duly qualified administrative law judge who shall be designated by the Secretary in a notice to the parties in the proceeding.

(b) Administrative law judges shall have the duty to conduct fair and impartial hearings, to take all necessary action to avoid delay in the disposition of proceedings and to maintain order. They shall have all powers necessary to those ends including all powers granted under 5 U.S.C. 556(c), and also power including but not limited to the following:

(1) To administer oaths and affirmations.

(2) To issue subpoenas and orders requiring access.

(3) To take or to cause depositions to be taken.

(4) To rule upon offers of proof and receive evidence.

(5) To regulate the course of the hearings and the conduct of the parties and their counsel.

(6) To hold conferences for simplification and clarification of the issues or any other purpose.

(7) To consider and rule upon as justice may require, all procedural and other motions appropriate in an adjudicative proceeding, including motions to open defaults.

(8) To make and file decisions.

(9) To certify question to a Departmental appeals officer.

(10) To take any action authorized by the rules in this part or other appropriate action.

§ 1720.145 Disqualification of administrative law judge.

(a) When an administrative law judge feels disqualified from presiding in a particular proceeding, the administrative law judge shall withdraw therefrom by notice on the record and shall notify the Secretary of such withdrawal.

(b) Whenever any party believes that the administrative law judge should be disqualified from presiding, or continuing to preside in a particular proceeding, such party may file with the administrative law judge a motion that the administrative law judge be disqualified and removed. Such motion shall be supported by affidavits setting forth the alleged grounds for disqualification. If the administrative law judge does not agree to disqualification, the hearing shall proceed, and the question of fair hearing and due process may be raised on appeal.

§ 1720.150 Failure to comply with administrative law judge's directions.

Any party who refuses or fails to comply with a lawfully issued order or direction of an administrative law judge may be considered to be in contempt of the Secretary. The circumstances of any such neglect, refusal or failure, together with a recommendation for appropriate action, shall be promptly certified by the administrative law judge to the Secretary who may make such orders in

§ 1720.155

regard thereto as the circumstances may warrant.

§ 1720.155 Ex parte communications.

(a) No person shall communicate with an administrative law judge or an appeals officer either directly or indirectly concerning any pending proceeding unless prior to or simultaneously with such communication its contents are disclosed in detail to all persons interested in the proceeding; nor shall an administrative law judge or appeals officer request or consider any such unauthorized ex parte communication. This prohibition shall not apply to a simple request for information respecting the status of the proceeding, nor to any ex parte communication expressly authorized by these rules.

(b) Any administrative law judge or appeals officer, who receives an ex parte communication which the judge knows or has reason to believe is unauthorized, shall promptly place the communication, or its substance, in the public file and shall inform all persons interested in the proceeding of its existence and general contents. Facts or arguments so communicated shall not be taken into account in deciding any matter in issue unless such facts or arguments shall be brought properly before the administrative law judge.

(c) Opportunity to answer allegations or contentions contained in an unauthorized ex parte communication may be afforded any interested person upon motion for leave to do so, wherever such leave will operate to assure a fair hearing or decision.

§ 1720.160 Form and filing requirements.

(a) *Filing.* Except as otherwise permitted, an original and three copies of all documents shall be filed with the Docket Clerk for Administrative Proceedings, Room 10278, Department of Housing and Urban Development, Washington, DC 20410, on official work days between the hours of 8:45 a.m. and 5:15 p.m.

(b) *Title.* Documents shall show clearly the title of the action, the docket number, and OILSR file number in connection with which they are filed.

24 CFR Ch. X (4-1-11 Edition)

(c) *Form.* Except as otherwise permitted, all documents shall be printed, typewritten, or otherwise processed in clear legible form and on good unglazed paper.

§ 1720.165 Time computation.

Computation of any period of time prescribed or allowed by the rules and regulations in this part, or by order of the Secretary or of an administrative law judge, shall begin with the first business day following that on which the act, event, development or default initiating such period of time shall have occurred. When the last day of the period so computed is a Saturday, Sunday, or national holiday, or other day on which the Department of Housing and Urban Development is closed, the period shall run until the end of the next following business day. Except when any prescribed or allowed period of time is 7 days or less, each of the Saturdays, Sundays, and national holidays shall be included in the computation of the prescribed or allowed period.

§ 1720.170 Service.

Notices, orders, processes, determinations and other documents required or permitted under these rules may be served as follows:

(a) *Upon the Secretary.* By personal delivery at the office, or by registered or certified mail addressed to the office of any of the following officials in the Office of Interstate Land Sales Registration: Administrator; Associate Administrator; Director, Office of Interstate Land Sales Registration: *Provided, however,* That during the pendency of a proceeding before the Secretary all pleadings, motions, notices or other documents shall be served in accordance with the terms of § 1720.160.

(b) *Upon any other person.* By delivery of a copy of the documents to the person to be served wherever the person may be found, or by leaving such copy at the person's office or place of business with a person apparently in charge thereof, or, if there is no one in charge or if the office is closed or if the person has no office, by leaving a copy at the person's residence with some person of suitable age and discretion then residing therein, or sending a

copy by registered or certified mail, return receipt requested, addressed to the person at the person's last known residence, or at the person's last known principal office or place of business. If the address of the residence, principal office, or place of business is unknown and cannot with due diligence be ascertained, service may be made by mail to any office at which the person to be served is known to be employed or by publication in the FEDERAL REGISTER.

(c) *Service on corporations, partnerships, associations, other entities.* Service may be made upon any corporation, partnership, business association or other entity by serving any officer, director, partner, trustee, agent for service or managing agent thereof. A managing agent, within the meaning of this subsection, is an agent having the principal managerial responsibility in connection with the regular operation of a distinct office or activity of the enterprise.

(d) *Service through attorney.* When a person other than the Secretary and the Secretary's staff shall have appeared of record in a proceeding, generally or specially, by attorney, all subsequent services of notices, orders, processes, and other documents in connection with such proceeding may be made upon such person by serving the attorney, except that subpoenas and other orders by which such person may be brought in contempt shall be served upon the person by one of the methods described in paragraphs (b) and (c) of this section. In any case, a copy of any document served on a client shall be sent to any attorney who has entered an appearance for that client. In such situations, it shall be sufficient proof of service to show that either the client or the attorney has received a copy of the document.

(e) *Proof of service.* Proof of service shall not be required unless the fact of service is reasonably put in issue by appropriate motion or objection on the part of the person allegedly served or other party. In such cases, service may be established by written admission signed by or on behalf of the person to be served, or may be established prima facie by affidavit or certificate of service or mailing, as appropriate. When

service is by registered or certified mail, it is complete upon delivery of the document by the post office.

§ 1720.175 Intervention by interested persons.

(a) The administrative law judge, upon timely petition in writing and for good cause shown, and if deemed to be in the public interest, may permit any person to participate by intervention in the proceeding. The petition shall state:

(1) The petitioner's relationship to and interest in the matters contained in the proceeding;

(2) The petitioner's position with respect to each specific issue upon which the petitioner proposes to intervene, and the facts which the petitioner proposes to adduce in support of each such position; and

(3) An assent to exercise of jurisdiction by the Department with respect to the petitioner.

(b) The administrative law judge shall determine the propriety of such intervention and the extent to which such intervener may participate, basing such determination upon applicable law, the directness and substantiality of the petitioner's interest in the proceeding and the effect upon the proceeding of allowing such participation.

§ 1720.180 Settlements.

Parties may propose in writing, at any time during the course of a proceeding, offers of settlement which shall be submitted to the Secretary. If determined to be appropriate, the party making the offer may be given an opportunity to make an oral presentation in support of such offer. If an offer of settlement is rejected, the party making the offer shall be so notified and the offer shall be deemed withdrawn and shall not constitute a part of the record in the proceeding. Final acceptance by the Secretary of any offer of settlement will terminate any proceeding related thereto upon notification to the administrative law judge or the appeals officer.

PLEADINGS

§ 1720.205 Suspension notice under § 1710.45(a) of this chapter.

A suspension pursuant to § 1710.45(a) of this chapter shall be effected by service of a suspension notice which shall contain:

(a) An identification of the filing to which the notice applies.

(b) A specification of the deficiencies of form, disclosure, accuracy, documentation or fee tender which constitute the grounds under § 1710.45(a) of this chapter, of the suspension, and of the additional or corrective procedure, information, documentation, or tender which will satisfy the Secretary's requirements.

(c) A notice of the hearing rights of the developer under § 1720.210 and of the procedures for invoking those rights.

(d) A notice that, unless otherwise ordered, the suspension shall remain in effect until 30 days after the developer cures the specified deficiencies as required by the notice.

§ 1720.210 Hearings—suspension notice pursuant to § 1710.45(a) of this chapter.

(a) A developer, upon receipt of a suspension notice issued pursuant to § 1710.45(a) of this chapter, may obtain a hearing by filing a written request in accordance with the instructions regarding such request contained in the suspension notice. Such a request must be filed within 15 days of receipt of the suspension notice and must be accompanied by an answer and 3 copies thereof signed by the respondent or the respondent's attorney conforming to the requirements of § 1720.245. Filing of a motion for a more definite statement pursuant to § 1720.315 shall alter the period of time to request a hearing in accordance with § 1720.240.

(b) When a hearing is requested pursuant to paragraph (a) of this section, such hearing shall be held within 20 days of receipt of the request. The time and place for hearing shall be fixed with due regard for the public interest and the convenience and necessity of the parties or their representatives.

(c) A request for hearing filed pursuant to paragraph (a) of this section shall not interrupt or annul the effec-

tiveness of the suspension notice, and suspension of the effective date of the Statement or amendment shall continue until vacated by order of the Secretary or administrative law judge. Except in cases in which the developer shall waive or withdraw the request for such hearing, or shall fail to pursue the same by appropriate appearance at a hearing duly scheduled, noticed and convened, the suspended filing shall be reinstated in the event of failure of the Secretary to schedule, give notice of or hold a duly-requested hearing within the time specified in paragraph (b) of this section, or in the event of a finding that the Secretary has failed to support at such hearing the propriety of the suspension with respect to the material issues of law and fact raised by the answer. Such reinstatement shall be effective on the date on which the filing would have become effective had no notice of suspension been issued with respect to it.

(d) If there is an outstanding suspension notice under § 1710.45(a) with respect to the same matter for which a suspension order under § 1710.45(b)(3) is issued, the notice and order shall be consolidated for the purposes of hearing. In the event that allegations upon which the suspension notice and suspension order are based are identical, only one answer need be filed.

§ 1720.215 Notice of proceedings pursuant to § 1710.45(b)(1) of this chapter.

A proceeding pursuant to § 1710.45(b)(1) of this chapter is commenced by issuance and service of a notice which shall contain:

(a) A clear and accurate identification of the filing or filings to which the notice relates.

(b) A clear and concise statement of material facts, sufficient to inform the respondent with reasonable definiteness of the statements, omissions, conduct, circumstances or practices alleged to constitute the grounds for the proposed suspension order under § 1710.45(b)(1) of this chapter.

(c) A notice of hearing rights of the developer under § 1720.220 and of the procedures for invoking those rights.

(d) Designation of the administrative law judge appointed to preside over

pre-hearing procedures and over the hearings.

(e) A notice that failure to file an answer or motion as provided under §1720.240 will result in an order suspending the Statement of Record.

§ 1720.220 Hearings—notice of proceedings pursuant to § 1710.45(b)(1) of this chapter.

(a) A developer, upon receipt of a notice of proceedings issued pursuant to §1710.45(b)(1) of this chapter, may obtain a hearing by filing a written request in accordance with the instructions regarding such request contained in the notice of proceedings. Such a request must be filed within 15 days of receipt of the notice of proceedings and must be accompanied by an answer conforming to the requirements of §1720.245. Filing of a motion for a more definite statement pursuant to §1720.315 shall alter the period of time to request a hearing in accordance with §1720.240.

(b) When a hearing is requested pursuant to paragraph (a) of this section, such hearing shall be held within 45 days of receipt of the request by the Secretary unless it is determined that it is not in the public interest. The time and place for hearing shall be fixed with due regard for the public interest and the convenience and necessity of the parties or their representatives.

(c) Failure to answer within the time allowed by §1720.140 or failure of a developer to appear at a hearing duly scheduled shall result in an appropriate order under §1710.45(b)(1) of this chapter suspending the statement of record. Such order shall be effective as of the date of service or receipt.

§ 1720.225 Suspension order under § 1710.45(b)(2) of this chapter.

A suspension pursuant to §1710.45(b)(2) of this chapter shall be effected by service of a suspension order which shall contain:

(a) An identification of the filing to which the order applies.

(b) Bases for issuance of order.

(c) A notice of the hearing rights of the developer under §1720.235 the procedures for invoking those rights.

(d) A statement that the order shall remain in effect until the developer has complied with the Secretary's requirements.

§ 1720.230 Suspension order under § 1710.45(b)(3) of this chapter.

A suspension pursuant to paragraph (b)(3) of §1710.45 of this chapter shall be effected by service of a suspension order which shall contain:

(a) An identification of the filing to which the order applies.

(b) An identification of the amendment to the filing which generated the order.

(c) A statement that the issuance of the order is necessary or appropriate in the public interest or for the protection of purchasers.

(d) A statement that the order shall remain in effect until the amendment becomes effective.

(e) A notice of the hearing rights of the developer under §1720.235 and of the procedure for invoking those rights.

§ 1720.235 Hearings—suspension orders issued pursuant to § 1710.45(b)(2) and § 1710.45(b)(3) of this chapter.

(a) A developer, upon receipt of a suspension order issued pursuant to §1710.45(b)(2) or §1710.45(b)(3) of this chapter, may obtain a hearing by filing a written request in accordance with the instructions regarding such request contained in the suspension order. Such request must be filed within 15 days of receipt of the suspension order and must be accompanied by an answer and 3 copies thereof signed by the respondent or respondent's attorney conforming to the requirements of §1720.245. Filing of a motion for a more definite statement pursuant to §1720.315 shall alter the period of time to request a hearing in accordance with §1720.240.

(b) When a hearing is requested pursuant to paragraph (a) of this section, such hearing shall be held within 20 days of receipt of the request. The time and place for hearing shall be fixed with due regard for the public interest and the convenience and necessity of the parties or their representatives.

(c) A request for hearing filed pursuant to paragraph (a) of this section

§ 1720.236

24 CFR Ch. X (4-1-11 Edition)

shall not interrupt or annul the effectiveness of the suspension order.

§ 1720.236 Notice of proceedings to withdraw a State's certification pursuant to § 1710.505 of this chapter.

A proceeding pursuant to § 1710.505 of this chapter is commenced by issuance and service of a notice which shall contain:

(a) An identification of the State certification to which the notice applies.

(b) A clear and concise statement of material facts, sufficient to inform the respondent with reasonable definiteness of the basis for the Secretary's determination, pursuant to § 1710.505, that the State's laws, regulations and the administration thereof, taken as a whole, no longer meet the requirements of § 1710. 501.

(c) A notice of hearing rights of the State under § 1720.237 and of the procedures for invoking those rights.

(d) A notice that failure to file an answer or motion as provided under § 1720.240 will result in an order suspending the State's certification.

[45 FR 40499, June 13, 1980]

§ 1720.237 Hearings—notice of proceedings pursuant to § 1710.505 of this chapter.

(a) A State, upon receipt of a notice of proceedings issued pursuant to § 1710.505 of this chapter, may obtain a hearing by filing a written request in accordance with the instructions regarding such request contained in the notice of proceedings. Such request must be filed within 15 days of receipt of the notice of proceedings and must be accompanied by an answer conforming to the requirements of § 1720.245. Filing of a motion for a more definite statement pursuant to § 1720.315 shall alter the period of time to request a hearing in accordance with § 1720.240.

(b) When a hearing is requested pursuant to paragraph (a) of this section, such hearing shall be held within 45 days of receipt of this request. The time and place for the hearing shall be fixed with due regard for the public interest and the convenience and necessity of the parties or their representatives.

(c) Failure to answer within the time allowed by § 1720.240 or failure to appear at a hearing duly scheduled shall result in an appropriate order under § 1710.505 of this chapter withdrawing the State's certification. Such order shall be effective as of the date of service or receipt.

[45 FR 40499, June 13, 1980]

§ 1720.238 Notices of proceedings to terminate exemptions pursuant to §§ 1710.14, 1710.15 and 1710.16 of this chapter.

A proceeding to terminate a self-determining exemption under § 1710.14 or an exemption order under § 1710.15 or § 1710.16 is commenced by issuance and service of a notice which shall contain:

(a) In the case of an exemption under § 1710.14, an identification of the developer and subdivision to which this notice applies. In the case of an exemption under either § 1710.15 or § 1710.16, an identification of the exemption order to which the notice applies.

(b) A clear and concise statement of material facts, sufficient to inform the respondent with reasonable definiteness of the basis for the Secretary's determination that further exemption from the registration and disclosure requirements is not in the public interest or that the sales or leases do not meet the requirements for exemption, or both.

(c) A notice of hearing rights of the respondent under § 1720.239 and of the procedures for invoking those rights.

(d) A notice that failure to file an answer or motion as provided under § 1720.240 will result, in the case of a notice issued under § 1710.14, an order terminating eligibility for the exemption, or, in the case of a notice issued under either § 1710.15 or § 1710.16, an order terminating the exemption order.

[45 FR 40499, June 13, 1980, as amended at 54 FR 40868, Oct. 4, 1989]

§ 1720.239 Hearings—notice of proceedings pursuant to §§ 1710.14, 1710.15 and 1710.16 of this chapter.

(a) A developer, upon receipt of a notice of proceedings issued under §§ 1710.14, 1710.15 and 1710.16 of this chapter, may obtain a hearing by filing a written request contained in the notice of proceedings. The request must

be filed within 15 days of receipt of the notice of proceedings and must be accompanied by an answer conforming to the requirements of § 1720.245. Filing of a motion for a more definite statement under § 1720.315 shall alter the period of time to request a hearing in accordance with § 1720.240.

(b) When a hearing is requested pursuant to paragraph (a) of this section, such hearing shall be held within 45 days of receipt of this request. The time and place for the hearing shall be fixed with due regard for the public interest and the convenience and necessity of the parties of their representatives.

(c) Failure to answer within the time allowed by § 1720.240, or failure to appear at a duly scheduled hearing shall result in an appropriate order under § 1710.14 § 1710.15 or § 1710.16 of this chapter terminating the developer's exemption. The order shall be effective as of the date of service or receipt.

[45 FR 40500, June 13, 1980, as amended at 54 FR 40868, Oct. 4, 1989]

§ 1720.240 Time for filing answer.

(a) Within 15 days after service of the notice or order, the respondent shall mail or submit to the Docket Clerk for Administrative Proceedings, Room 10278, Department of Housing and Urban Development, Washington, DC 20410, an answer and three copies thereof signed by the respondent or attorney. Unless a different time is fixed by the Secretary, the filing of a motion for a more definite statement of the allegations shall alter the period of time in which to file an answer as follows:

(1) If the motion is denied, the answer shall be filed within 15 days after service of the denial.

(2) If the motion is granted in whole or in part, the more definite statement of allegations shall be filed after service of the order granting the motion and the answer shall be filed within 15 days after service of the more definite statement of allegations.

(b) If a notice or order is amended pursuant to § 1720.255(a), the respondent shall have 15 days after service of the amended notice or order within which to file an answer.

§ 1720.245 Content of answer.

(a) An answer to a notice or order shall contain:

(1) Specific admission, denial or explanation of each fact alleged in the notice or, if the respondent is without knowledge thereof, a statement to that effect; and

(2) A brief statement of the facts constituting each defense.

(b) Allegations not answered in this manner shall be deemed admitted.

§ 1720.250 Presumption of hearing request.

When an answer to a suspension notice, a notice of proceedings, or a suspension order is timely filed but a respondent has failed specifically to request a hearing, the answer shall be deemed to constitute such a request.

§ 1720.255 Amendments and supplemental pleadings.

(a) *Amendments.* Prior to the receipt by the Docket Clerk for Administrative Proceedings of an answer to a notice or order, that notice or order may be amended as a matter of course. After the receipt of an answer, the administrative law judge may allow appropriate amendments to pleadings by motion whenever determination of a controversy on the merits will be facilitated thereby.

(b) *Variances of proof.* When issues not raised by the pleadings but reasonably within the scope of the suspension notice or notice of proceedings are tried by express or implied consent of the parties, they shall be treated in all respects as if they had been raised in the pleadings; and such amendments of the pleadings as may be necessary to make them conform to the evidence and to raise such issues shall be allowed at any time.

(c) *Supplemental pleadings.* The administrative law judge may, upon reasonable notice and such terms as are just, permit service of a supplemental pleading setting forth transactions or events which have occurred since the date of the pleading sought to be supplemented and which are relevant to any of the issues involved.

§ 1720.260

24 CFR Ch. X (4-1-11 Edition)

§ 1720.260 Prehearing conferences.

(a) Where it will expedite the proceeding, the administrative law judge may direct or allow the parties or their representatives to appear for a conference to consider:

- (1) Simplification and clarification of the issues;
- (2) Necessity or desirability of amendments to the pleadings;
- (3) Stipulations and admissions of fact and the contents and authenticity of documents;
- (4) Expedition in the discovery and presentation of evidence;
- (5) Matters of which official or judicial notice will be taken; and
- (6) Such other matters as may aid in the orderly and expeditious disposition of the proceeding, including disclosure of the names of witnesses and of documents or other exhibits which will be introduced in evidence in the course of the proceeding.

Prior to the conference, the administrative law judge may direct or allow the parties or their representatives to file memoranda specifying the issues of law and fact to be considered.

(b) If the circumstances are such that a conference is impracticable, the administrative law judge may require the parties to correspond for the purpose of accomplishing any of the objectives set forth in this section.

§ 1720.265 Reporting—prehearing conferences.

Prehearing conferences shall be stenographically or mechanically reported; and the administrative law judge shall prepare and file for the record a written summary of the action taken at the conference, which shall incorporate any written agreements or stipulations made by the parties at the conference or as a result of the conference.

MOTIONS

§ 1720.305 Motions—filing requirements.

During the time a proceeding is before an administrative law judge, all motions therein shall be in writing; and, except as otherwise provided in this part, a copy of each motion shall be served on the other party or parties.

Such motions shall be signed, addressed to, filed with and ruled upon by the administrative law judge. The provisions of this section need not apply to motions made during the course of a hearing.

§ 1720.310 Answers to motions.

Within 7 days after service of any written motion, an opposing party shall answer or shall be deemed to consent to the granting of the relief asked for in the motion. The moving party shall have no right to reply except as permitted by the administrative law judge or the appeals officer.

§ 1720.315 Motion for more definite statement.

When a respondent is unable to respond to the allegations in a suspension notice, a notice of proceedings, or a suspension order, because such allegations are vague, unclear or otherwise indefinite, motion may be made requesting a more definite statement of the allegations before filing an answer. Such motion shall indicate specifically in what manner the notice or order is indefinite or defective and shall be mailed or submitted to the Docket Clerk for Administrative Proceedings, Room 10278, Department of Housing and Urban Development, Washington, DC 20410, within five days after service of the notice or order.

§ 1720.320 Motions for extension of time.

As a matter of discretion, the administrative law judge or the appeals officer may waive the requirements of §1720.310 as to motions for extension of time, and may rule upon such motions ex parte. Extensions of time or continuances in any proceeding may be ordered on a motion by the administrative law judge or on the motion of either party for sufficient cause after the policy of the Secretary under §1720.125 has been considered.

§ 1720.325 Motions for dismissal.

(a) A motion to dismiss may be made at any time until and including the fifth day after the close of the case for the reception of evidence.

(b) When a motion to dismiss, based upon alleged failure to establish a

prima facie case, is made at the close of the evidence offered in support of the notice or order, the administrative law judge may defer ruling thereon until the close of the case for the reception of evidence.

(c) When a motion to dismiss is granted so as to terminate entirely the proceeding before the administrative law judge, the administrative law judge shall file a decision in accordance with the provisions of §1720.525. If such a motion is granted only as to some allegations or as to some respondents, the administrative law judge shall enter this partial determination on the record and take it into account in the decision.

§ 1720.330 Motions to limit or quash.

Any person to whom a subpoena is directed may, prior to the time specified therein for compliance, but in no event more than 5 days after the date of service of such subpoena, apply to the administrative law judge to quash or modify such subpoena, accompanying such application with a brief statement of the reasons therefor. The administrative law judge shall have the discretion of granting, denying or modifying said motion.

§ 1720.335 Consolidation.

When more than one proceeding involves a common question of law or fact, the administrative law judge may order a joint hearing of any or all of the matters in issue in the proceedings and may make such other orders concerning the proceedings as to avoid unnecessary costs or delay.

DISCOVERY AND EVIDENCE

§ 1720.405 Depositions and discovery.

(a) At any time during the course of a proceeding, the administrative law judge may discretionally order the taking of a deposition and the production of documents by the deponent. Such order may be entered upon a showing that the deposition is necessary for the purpose of discovery or to preserve relevant evidence. Insofar as consistent with considerations of fairness and the requirements of due process and the rules of this subpart, a deposition shall not be ordered when it appears that it

will result in undue burden to any other party or in undue delay of the proceeding. Depositions may be taken orally or upon written interrogatories and cross-interrogatories.

(b) Any party desiring to take a deposition shall make application in writing to the administrative law judge setting forth the justification therefor and the time and place proposed for the taking of the deposition. The application shall include also the name and address of each proposed deponent and the subject matter concerning which each is expected to depose and shall be accompanied by an application for any subpoenas desired.

(c) An order that the administrative law judge may issue for taking a deposition shall state the circumstances warranting its being taken, and shall designate the time and place and shall show the name and address of each person who is expected to appear and the subject matter with regard to which each is expected to depose. The time designated shall allow not less than 5 days from date of service of the order when the deposition is to be taken within the United States, and not less than 15 days when the deposition is to be taken elsewhere.

(d) After an order is served for taking a deposition upon motion timely made by any party or by the person to be deposed and for good cause shown, the administrative law judge may determine the propriety of and issue any of the following orders:

(1) That the deposition shall not be taken.

(2) That it may be taken only at some designated place other than that stated in the order.

(3) That it may be taken only on written interrogatories.

(4) That certain matters shall not be inquired into.

(5) That the examination shall be held with no one present except the parties to the action, their counsel and a person qualified in the designated place to administer oaths and affirmations.

(e) The administrative law judge may make any other order which justice requires to protect the party or deponent from annoyance, embarrassment or oppression, or to prevent the unnecessary

§ 1720.410

disclosure or publication of information contrary to the public interest and beyond the requirements of justice in the particular proceeding.

(f) Each deponent shall be duly sworn, and any adverse party shall have the right to cross-examine. Objections to questions or documents shall be in short form, stating the grounds of objections relied upon. The questions and the answers, together with all objections made, but excluding argument or debate, shall be reduced to writing and certified by the person before whom the deposition was taken. Thereafter such person shall forward the deposition and one copy thereof to the party at whose instance the deposition was taken, and shall forward one copy thereof to the representative of each party who was present or represented at the taking of the deposition.

(g) A deposition taken to preserve relevant evidence which any party intends to offer in evidence may be corrected in the manner provided by §1720.515. Any such deposition shall, in addition to the other required procedures, be read to or by the deponent and be subscribed by the deponent if the party intending to offer it in evidence so notifies the person before whom the deposition was taken. Subject to appropriate rulings on such objections to the questions and answers as were noted at the time the deposition was taken or as may be valid when it is offered, a deposition taken to preserve relevant evidence, or any part thereof, may be used or offered in evidence as against any party who was present or represented at the taking of the deposition or who had due notice thereof if the administrative law judge finds any of the following:

- (1) That the deponent is dead.
- (2) That the deponent is out of the United States or is located at such a distance that attendance would be impractical, unless it appears that the absence of the deponent was procured by the party offering the deposition.
- (3) That the deponent is unable to attend or testify because of age, sickness, infirmity or imprisonment.
- (4) That the party offering the deposition has been unable to procure the attendance of the deponent by subpoena.

24 CFR Ch. X (4-1-11 Edition)

(5) That such exceptional circumstances exist as to make it desirable, in the interest of justice and with due regard to the importance of presenting the testimony of witnesses orally in open hearing, to allow the deposition to be used.

§ 1720.410 Subpoenas ad testificandum.

Application for issuance of a subpoena requiring a person to appear and depose or testify at the taking of a deposition or at an adjudicative hearing shall be made to the administrative law judge who may issue such subpoena.

§ 1720.415 Subpoenas duces tecum.

(a) Application for issuance of a subpoena requiring a person to appear and depose or testify and to produce specific documents, papers, books, or other physical exhibits at the taking of a deposition, or at a prehearing conference, or at an adjudicative hearing shall be made in writing to the administrative law judge who may issue such subpoena and shall specify as exactly as possible the general relevancy of the material and the reasonableness of the scope of the subpoena.

(b) Subpoenas duces tecum may be used by any party for purposes of discovery or for obtaining documents, papers, books, or other physical exhibits for use in evidence, or for both purposes. When used for discovery purposes a subpoena may require a person to produce and permit the inspection and copying of nonprivileged documents, papers, books, or other physical exhibits which constitute or contain evidence relevant to the subject matter involved and which are in the possession, custody or control of such person.

§ 1720.420 Rulings on applications for compulsory process; appeals.

(a) Applications for orders requiring the production of witnesses' statements pursuant to the provisions of §1720.430, applications for orders requiring the taking of depositions pursuant to §1720.405 and applications for the issuance of subpoenas pursuant to §§1720.410 and 1720.415 may be made ex

parte, and, if so made, such applications and the rulings thereon shall remain ex parte unless otherwise ordered by the administrative law judge. Such applications shall be ruled upon by the administrative law judge assigned to hear the case or, in the event that judge is not available, by another administrative law judge designated by the Secretary.

(b) Appeals to an appeals officer from rulings denying applications within the scope of paragraph (a) of this section, or from rulings on motions to limit or quash process issued pursuant to such applications will be entertained by the appeals officer only upon a showing that the ruling complained of involves substantial rights and will materially affect the final decision, and that a determination of its correctness before conclusion of the hearing is essential to serve the interests of justice. Such appeals shall be made on the record, shall briefly state the grounds relied on and shall be filed within 5 days after notice of the ruling complained of. Appeals from denials of ex parte applications shall have annexed thereto copies of the applications and rulings involved. Any answer to such appeal shall not operate to suspend the hearing unless otherwise ordered by the administrative law judge or the appeals officer.

§ 1720.425 Presentation and admission of evidence.

(a) All witnesses at a hearing for the purpose of taking evidence shall testify under oath or affirmation which shall be administered by the administrative law judge. Every party shall have the right to present such oral or documentary evidence and to conduct such cross-examinations as may be required for a full and true disclosure of the facts. The administrative law judge shall receive relevant and material evidence, rule upon offers of proof and exclude all irrelevant, immaterial or unduly repetitious evidence.

(b) Evidence shall not be excluded merely by application of technical rules governing its admissibility, competency, weight or foundation in the record; but evidence lacking any significant probative value, or substantially tending merely to confuse or ex-

tend the record, shall be excluded. The administrative law judge may allow arguments on the admissibility of evidence by analogy to the Federal Rules of Evidence currently applicable in the United States District Courts of the United States.

(c) When offered evidence is excluded, the party offering the same shall be permitted to state on the record an offer of proof with respect thereto and rejected exhibits, adequately marked, shall on request of the party offering the same be retained in the record for purposes of review. Evidence may be received subject to deferred ruling on objections to its admissibility.

(d) Objections to evidence shall be timely made and shall specify the particular ground of objection without argument except as argument may be expressly required by the administrative law judge. Formal exception to an adverse ruling is unnecessary.

§ 1720.430 Production of witnesses' statements.

After a witness called by the attorney for the Office of Interstate Land Sales Registration has given direct testimony in a hearing, any other party may request and obtain the production of any statement, or part thereof, of such witness pertaining to the witness' direct testimony in the possession of the Office of Interstate Land Sales Registration, subject, however, to the limitations applicable to the production of witnesses' statements under the Jencks Act, 18 U.S.C. 3500.

§ 1720.435 Official notice.

Official notice may be taken of any material fact which might be judicially noticed by a District Court of the United States, any matter in the public official records of the Office of Interstate Land Sales Registration or any matter which is peculiarly within the knowledge of the administrative law judge. When any decision of an administrative law judge rests, in whole or in part, upon the taking of official notice of a material fact not appearing in evidence of record, opportunity to disprove such noticed fact shall be granted any party making timely request therefor.

§ 1720.505

24 CFR Ch. X (4-1-11 Edition)

HEARINGS

§ 1720.505 Interlocutory review of administrative law judge's decision.

(a) The appeals officer will not review a ruling of an administrative law judge prior to the appeals officer's consideration of the entire proceeding in the absence of extraordinary circumstances. Except as provided in § 1720.140 an administrative law judge shall not certify a ruling for interlocutory review to an appeals officer unless a party so requests and the administrative law judge is of the opinion and finds either on the record or in writing that:

(1) A subsequent reversal of the ruling would cause unusual delay or expense, taking into consideration the probability of such reversal, or

(2) Substantial rights are at stake and the final decision might be materially affected.

(b) The certification by the administrative law judge shall be in writing and shall specify the material relevant to the ruling involved. The appeals officer may decline to consider the ruling certified if the officer determines that interlocutory review is not warranted or appropriate under the circumstances. If the administrative law judge does not certify a matter, a party who had requested certification may apply to the appeals officer for review. An application for review shall be in writing and shall briefly state the grounds relied on and shall be filed within 2 days after notice of the ruling complained of. Review will not be granted unless the appeals officer concludes that the administrative law judge erred in failing to certify the matter. Unless otherwise ordered by the administrative law judge, the hearing shall continue whether or not such certification or application is made. Failure to request certification or to make such application will not waive the right to seek review of the ruling of the administrative law judge after the close of the hearing.

[43 FR 29496, July 7, 1978, as amended at 50 FR 10942, Mar. 19, 1985]

§ 1720.510 Reporting and transcription.

Hearings shall be stenographically or mechanically reported and transcribed under the supervision of the administrative law judge. The original transcript shall be a part of the record and the sole official transcript. Copies of transcripts shall be available from the reporter at rates not to exceed the maximum rates fixed by contract between the Secretary and the reporter.

§ 1720.515 Corrections.

Corrections of the official transcript ordered by the administrative law judge shall be included in the record. Corrections shall not be ordered by the administrative law judge except upon notice and opportunity for the hearing of objections. Such corrections shall be made by the reporter by furnishing substitute pages, under the usual certificate of the reporter, for insertion in the official record.

§ 1720.520 Proposed findings, conclusions, and order.

The administrative law judge may fix a reasonable time, not to exceed 30 days after the close of the evidence, during which any party may file with the administrative law judge proposed findings of fact, conclusions of law and rules or orders together with briefs in support thereof. Such proposals shall be in writing, shall be served upon all parties and shall contain adequate references to the record and to authorities relied on. The record shall show the administrative law judge's ruling on each proposed finding and conclusion, except when the rule or order disposing of the proceeding otherwise informs the parties of the action taken thereon.

§ 1720.525 Decision of administrative law judge.

(a) The administrative law judge shall make and file a decision within 30 days after the close of the taking of evidence in cases in which a hearing is held.

(b) The decision shall be effective 10 days after service upon the parties unless a petition for appeal is filed pursuant to § 1720.605 which shall serve to

stay the effectiveness of the decision while the appeal procedure is ongoing.

§ 1720.530 Decision of administrative law judge—content.

The administrative law judge's decision shall include a statement of:

(a) Findings, with specific references to principal supporting items of evidence in the record and conclusions, as well as the reasons or bases therefor, upon all of the material issues of fact, law or discretion presented on the record, and

(b) An appropriate order.

The administrative law judge's decision shall be based upon a consideration of the whole record and supported by reliable, probative and substantial evidence.

§ 1720.535 Reopening of proceeding; termination of jurisdiction.

(a) At any time prior to the filing of the decision, the administrative law judge may reopen the proceeding for the reception of further evidence.

(b) The jurisdiction of the administrative law judge is terminated when the decision becomes effective unless and until the proceeding is remanded to the judge by the appeals officer or a court of appropriate jurisdiction. The administrative law judge may *sua sponte* or on motion of a party file corrections of clerical errors.

APPEALS

§ 1720.605 Appeal from decision of administrative law judge.

(a) *Petition for appeal.* The administrative law judge's decision may be appealed by filing a written petition for appeal with the Docket Clerk for Administrative Proceedings within 10 days after service of the decision appealed from. Copies of the petition for appeal shall be served on all interested parties. The petition shall be limited to specifying the findings and conclusions to which exceptions are taken, together with a summary of the reasons in support of such exceptions.

(b) *Denial of petition.* A petition for appeal of the decision of the administrative law judge may be denied by the appeals officer. The petition shall be ruled on by the appeals officer within

10 days after filing. A denial of the petition shall be final agency action and shall render the administrative law judge's decision immediately effective.

(c) *Appeal brief.* If the appeals officer grants the petition, the appeal shall be perfected by filing within 30 days after service of the decision granting the petition a brief conforming to § 1720.620. In addition, the appellant shall submit a proposed order for the consideration of the appeals officer.

§ 1720.610 Answering brief.

Within 20 days after service of an appeal brief upon a party, such party may file an answering brief conforming to the requirements of § 1720.620.

§ 1720.615 Reply brief.

A brief in reply to an answering brief, limited to rebuttal of matters in the answering brief, may be filed and served by a party within 7 days after receipt of the answering brief or the day preceding oral argument whichever is earlier. No answer to a reply brief will be permitted.

§ 1720.620 Length and form of briefs.

No brief shall exceed 60 pages in length except with the permission of the administrative law judge or the appeals officer on the Interstate Land Sales Board and shall contain, in the order indicated, the following:

(a) The title of the proceeding, file number, the name of the party on whose behalf it is submitted and the name and address of the attorney in the matter on the front cover or title page.

(b) Subject index with page references.

(c) Table of cases alphabetically arranged, statutes, texts, and other authorities and materials cited, with page references.

(d) A concise statement of the facts of the case, without argument.

(e) A concise statement of the questions sought to be raised.

(f) The argument, presenting clearly the points of fact and law relied upon in support of the position taken on each question with specific page references to the record so far as available, and to legal authority or other

§ 1720.625

24 CFR Ch. X (4-1-11 Edition)

material relied upon in support of statements contained in the argument.

§ 1720.625 Oral argument.

Oral arguments will not be heard in cases on appeal to the appeals officer unless the officer otherwise orders, and stenographic or mechanical record of such oral argument may be made, in the officer's discretion. The purpose of oral argument is to emphasize and clarify the written argument appearing in the briefs and to answer questions.

§ 1720.630 Decision on appeal or review.

(a) Upon appeal from or review of an administrative law judge's decision, the appeals officer will consider such parts of the record as are cited or as may be necessary to resolve the issues and, in addition, to the extent necessary or desirable, will exercise all the powers which could have been exercised had the appeals officer made the initial decision. Unless exceptional circumstances are present, however, all appeals and reviews will be determined upon the record made before the administrative law judge.

(b) The appeals officer may affirm, reverse, modify, set aside or remand for further proceedings, in whole or in

part, the administrative law judge's decision. The appellate order shall set forth the reasons upon which the decision is based.

(c) In those cases where the appeals officer believes that further information or additional arguments of the parties are needed as to the form and content of the rule or order to be issued, the appeals officer may withhold final decision pending the receipt of such additional information or argument under procedures specified.

(d) The decision of the appeals officer shall be final 10 days after service upon the parties.

(e) The appeals officer shall render a decision within 30 days after the date of receipt of the reply brief or the taking of additional information and evidence, whichever is later.

§ 1720.635 Appeals officer.

The Secretary shall hear, consider and determine fully and finally all appeals from decisions made pursuant to the rules in this part by the administrative law judge; provided, however, that the Secretary may, upon lawful delegation, designate a staff member or other person to serve as the appeals officer.

CHAPTER XII—OFFICE OF INSPECTOR
GENERAL, DEPARTMENT OF HOUSING AND
URBAN DEVELOPMENT

<i>Part</i>		<i>Page</i>
2000–2001	[Reserved]	
2002	Availability of information to the public	89
2003	Implementation of the Privacy Act of 1974	95
2004	Subpoenas and production in response to sub- poenas or demands of courts or other authorities	98

PARTS 2000–2001 [RESERVED]

PART 2002—AVAILABILITY OF INFORMATION TO THE PUBLIC

- Sec.
- 2002.1 Scope of the part and applicability of other HUD regulations.
- 2002.3 OIG's overall policy concerning discloseable records and requests for OIG records.
- 2002.5 Records produced upon request when reasonably described.
- 2002.7 OIG processing of requests.
- 2002.9 Where to review records.
- 2002.11 Review of records, aggregating requests and waiving or reducing fees.
- 2002.13 Charges for interest and for unsuccessful searches; utilization of Debt Collection Act.
- 2002.15 Advance payments.
- 2002.17 Time limitations.
- 2002.19 Authority to release records or copies.
- 2002.21 Authority to deny requests for records and form of denial.
- 2002.23 Effect of denial of request.
- 2002.25 Administrative review.

AUTHORITY: 5 U.S.C. 552; Electronic Freedom of Information Act (Pub. L. 104–231); Freedom of Information Reform Act of 1986 (Pub. L. 99–579); 5 U.S.C. App. 3 (Inspector General Act of 1978); 42 U.S.C. 3535(d); Delegation of Authority, Jan. 9, 1981 (46 FR 2389).

SOURCE: 49 FR 11165, Mar. 26, 1984, unless otherwise noted.

§ 2002.1 Scope of the part and applicability of other HUD regulations.

(a) *General.* This part contains the regulations of the Office of Inspector General which implement the Freedom of Information Act (5 U.S.C. 552). It informs the public how to request records and information from the Office of Inspector General and explains the procedure to use if a request is denied. Requests for documents made by subpoena or other order are governed by procedures contained in part 2004 of this chapter. In addition to the regulations in this part, the following provisions of part 15 of this title covering the production or disclosure of material or information apply (except as limited in paragraph (b) of this section) to the production or disclosure of material in the possession of the Office of Inspector General:

§ 15.2—What definitions apply to this part?

§ 15.3—What exemptions are authorized by 5 U.S.C. 552?;

§ 15.108—What are HUD's policies concerning designating confidential commercial or financial information under Exemption 4 of the FOIA and responding to requests for business information?

§ 15.110—What fees will HUD charge?

(b) Limited applicability of section 15.110. For purposes of this part, paragraphs (d) through (k) of § 15.110 are not applicable.

(c) Use of the term “HUD”. For purposes of this part, and when the words “HUD” or “Department” are used in this part or §§ 15.2(b), 15.3, 15.108 and 15.110 of this title, the term means the Office of the Inspector General.

(d) Request for declassification and release of classified material. Section 15.107 of this title contains provisions for requesting declassification and release of declassified material.

[67 FR 47216, July 17, 2002]

§ 2002.3 OIG's overall policy concerning discloseable records and requests for OIG records.

(a) The Office of Inspector General will fully and responsibly disclose its identifiable records and information consistent with competing public interests, such as national security, personal privacy, grand jury and investigative secrecy, complainant confidentiality, agency deliberative process, as are recognized by FOIA and other federal statutes.

(b) A request for Office of Inspector General records may be made in person during normal business hours at any office where Office of Inspector General employees are permanently stationed. Although oral requests may be honored, a requester may be asked to submit the request in writing. A written request shall be addressed to: The Office of Inspector General, Department of Housing and Urban Development, 451 Seventh Street, SW, Room 8260, Washington, DC 20410.

(c) Each request must reasonably describe the desired record including the name, subject matter, and number or date, where possible, so that the record

§ 2002.5

may be identified and located. The request should also include the name, address and telephone number of the requester, and the format in which the requester would like the desired record to be reproduced. In order to enable the Office of Inspector General to comply with the time limitations set forth in § 2002.17, both the envelope containing a written request and the letter itself should clearly indicate that the subject is a Freedom of Information Act request.

(d) The request must be accompanied by the fee or an offer to pay the fee as determined in § 15.110.

(e) Copies of available records will be made as promptly as possible. Copying service will be limited to not more than 10 copies of any single page. Records that are published or available for sale need not be reproduced.

(f) To the extent that records are readily reproducible, the Office of Inspector General will send records in the form requested, including electronic format.

[67 FR 47217, July 17, 2002]

§ 2002.5 Records produced upon request when reasonably described.

(a) When a request is made which reasonably describes a record of the Office of Inspector General (see § 2002.3) which has been stored in the National Archives or other record center of the General Services Administration, the record will be requested by the Office of Inspector General if it otherwise would be available under this part.

(b) Every effort will be made to make a record in use by the staff of the Office of Inspector General available when requested, and such availability will be deferred only to the extent necessary to avoid serious interference with the business of the Office of Inspector General.

§ 2002.7 OIG processing of requests.

(a) *Multitracking.* (1) The Office of Inspector General places each request in one of two tracks. The Office of Inspector General places requests in its simple or complex track based on the amount of work and time involved in processing the request. Factors the Office of Inspector General will consider in assigning a request in the simple or

24 CFR Ch. XII (4–1–11 Edition)

complex track will include whether the request involves the processing of voluminous documents and/or whether the request involves responsive documents from more than one organizational unit. Within each track, the Office of Inspector General processes requests in the order in which they are received.

(2) For requests that have been sent to the wrong office, the Office of Inspector General will assign the request within each track using the earlier of either:

(i) The date on which the request was referred to the appropriate office; or,

(ii) The end of the ten (10) working day period in which the request should have been referred to the appropriate office.

(b) *Expedited processing.* The Office of Inspector General may take your request or appeal out of normal order if the Office of Inspector General determines that you have a compelling need for the records or in other cases as determined by the Office of Inspector General. If the Office of Inspector General grants your request for expedited processing, the Office of Inspector General will give your request priority and will process it as soon as practicable. The Office of Inspector General will consider a compelling need to exist if:

(1) Your failure to obtain the requested records on an expedited basis could reasonably be expected to pose an imminent threat to the life or physical safety of an individual or a threatened loss of substantial due process rights; or,

(2) You are primarily engaged in disseminating information and there is an urgency to inform the public concerning actual or alleged Federal Government activity.

[67 FR 47217, July 17, 2002]

§ 2002.9 Where to review records.

(a) You may inspect and copy hardcopy records that section 552(a)(2) of FOIA requires the Office of Inspector General make available to the public in reading rooms. At the Headquarters and DC Offices, this would be at HUD's Library, Room 8141, 451 Seventh St., SW, Washington, DC 20410, and should be coordinated through Counsel's Office to the Inspector General, Room

8260. Local offices may coordinate for local requests.

(b) For records created on or after November 1, 1996, this information is available to you through the Office of Inspector General's Internet website at <http://www.hud.gov/oig/oigindex.html>.

[67 FR 47217, July 17, 2002]

§ 2002.11 Review of records, aggregating requests and waiving or reducing fees.

(a) *Review of records.* Only requesters who are seeking documents for commercial use may be charged for the time HUD spends reviewing records to determine whether they are exempt from mandatory disclosure. Charges may be assessed only for the initial review (i.e., the review undertaken the first time HUD analyzes the applicability of a specific exemption to a particular record or portion of a record). HUD will not charge for review at the administrative appeal level of an exemption already applied. However, records or portions of records withheld in full under an exemption which is subsequently determined not to apply may be reviewed again to determine the applicability of other exemptions not previously considered. The costs for such a subsequent review would be properly assessable. Review time will be assessed at the same rates established for search time in § 15.110 of this title.

(b) *Aggregating requests.* A requester may not file multiple requests at the same time, each seeking portions of a document or documents, solely in order to avoid payment of fees. When HUD reasonably believes that a requester or a group of requesters acting in concert, is attempting to break a request down into a series of requests for the purpose of evading the assessment of fees, HUD may aggregate any such requests and charge accordingly.

(c) *Waiving or reducing fees.* HUD will furnish documents without charge or at reduced charge if disclosure of the information is in the public interest because it is likely to contribute significantly to public understanding of the operations or activities of the government and is not primarily in the commercial interest of the requester. The official authorized to grant access

to records may waive or reduce the applicable fee where requested. The determination not to waive or reduce the fee will be subject to administrative review as provided in § 2002.25 after the decision on the request for access has been made. Six factors shall be used in determining whether the requirements for a fee waiver or reduction are met. These factors are as follows:

(1) *The subject of the request:* Whether the subject of the requested records concerns "the operations or activities of the government";

(2) *The informative value of the information to be disclosed:* Whether the disclosure is "likely to contribute" to an understanding of government operations or activities;

(3) *The contribution to an understanding of the subject by the general public likely to result from disclosure:* Whether disclosure of the requested information will contribute to "public understanding";

(4) *The significance of the contribution to public understanding:* Whether the disclosure is likely to contribute "significantly" to public understanding of government operations or activities;

(5) *The existence and magnitude of a commercial interest:* Whether the requester has a commercial interest that would be furthered by the requested disclosure; and, if so

(6) *The primary interest in disclosure:* Whether the magnitude of the identified commercial interest of the requester is sufficiently large, in comparison with the public interest in disclosure, that disclosure is "primarily in the commercial interest of the requester."

[53 FR 37551, Sept. 27, 1988, as amended at 67 FR 47217, July 17, 2002]

§ 2002.13 Charges for interest and for unsuccessful searches; utilization of Debt Collection Act.

(a) *Charging interest.* HUD will begin assessing interest charges on an unpaid bill starting on the 31st day following the day on which the billing was sent. A fee received by HUD, even if not processed, will suffice to stay the accrual of interest. Interest will be at the rate prescribed in section 3717 of title 31 U.S.C. and will accrue from the date of the billing.

§ 2002.15

(b) *Charge for unsuccessful search.* Ordinarily no charge for search time will be assessed when the records requested are not found or when the records located are withheld as exempt. However, if the requester has been notified of the estimated cost of the search time and has been advised specifically that the requested records may not exist or may be withheld as exempt, fees shall be charged.

(c) *Use of Debt Collection Act of 1982.* When a requester has failed to pay a fee charged in a timely fashion (*i.e.*, within 30 days of the date of the billing), HUD may, under the authority of the Debt Collection Act and part 17, subpart C of this title, use consumer reporting agencies and collection agencies, where appropriate, to recover the indebtedness owed the Department.

[53 FR 37552, Sept. 27, 1988]

§ 2002.15 Advance payments.

(a) HUD may not require a requester to make an advance payment, *i.e.*, payment before work is commenced or continued on a request, unless:

(1) HUD estimates or determines that allowable charges that a requester may be required to pay are likely to exceed \$250. Then, HUD will notify the requester of the likely cost and obtain satisfactory assurance of full payment where the requester has a history of prompt payment of FOIA fees, or require an advance payment of an amount up to the full estimated charges in the case of requesters with no history of payment; or

(2) Where a requester has previously failed to pay a fee charged in a timely fashion (*i.e.*, within 30 days of the date of the billing), HUD may require the requester to pay the full amount owed plus any applicable interest as provided by § 2002.13(a) or demonstrate that he has, in fact, paid the fees, and to make an advance payment of the full amount of the estimated fee before HUD begins to process a new request or a pending request from that requester.

(b) When HUD acts under paragraph (a)(1) or (a)(2) of this section, the administrative time limits prescribed in subsection (a)(6) of the FOIA (*i.e.*, 20 working days from receipt of initial requests and 20 working days from receipt of appeals from initial denial,

24 CFR Ch. XII (4-1-11 Edition)

plus permissible extensions of these time limits) will begin only after HUD has received fee payments described in paragraph (a) of this section.

(c) Where it is anticipated that either the duplication fee individually, the search fee individually, or a combination of the two exceeds \$25.00 over and above the free search time and duplication costs, where applicable, and the requesting party has not indicated in advance a willingness to pay so high a fee, the requesting party shall be promptly informed of the amount of the anticipated fee or such portion thereof as can readily be estimated. The notification shall offer the requesting party the opportunity to confer with agency representatives for the purpose of reformulating the request so as to meet that party's needs at a reduced cost.

[53 FR 37552, Sept. 27, 1988, as amended at 67 FR 47217, July 17, 2002]

§ 2002.17 Time limitations.

(a) Upon receipt of a request for records, the appropriate Assistant Inspector General or an appointed designee will determine within twenty (20) working days whether to grant the request. The Assistant Inspector General or designee will notify the requestor immediately in writing of the determination and the right of the person to request a review by the Inspector General of an adverse determination.

(b) The time of receipt for processing a request for records purposes is the time it is received by the appropriate office for review. If a request is misdirected by the requester, the Office of Inspector General or Department official who receives the request will promptly refer it to the appropriate office and will advise the requester about the delayed time of receipt.

(c) A determination with respect to a request for review by the Inspector General of HUD under § 2002.25 will be made within 20 working days after receipt and will be communicated immediately to the person requesting review.

(d) If the Office of Inspector General grants the request for records, the records will be made available promptly to the requester.

(e) In unusual circumstances as specified in this paragraph, and subject to the concurrence of any Assistant Inspector General or appointed designee, the time limits prescribed in either paragraph (a) or (c) of this section may be extended. Any extension will be in writing to the requester and will include reasons for the extension and the date on which the disposition of the request will be sent. No extension will be for more than ten working days. As used in this paragraph, *unusual circumstances* means (but only to the extent necessary to the proper processing of the particular request) that there is a need:

(1) To search for and collect the requested records from field facilities or other establishments that are separate from the office processing the request; or

(2) To search for, collect, and appropriately examine a voluminous amount of separate and distinct records which are demanded in a single request; or

(3) For consultation, which shall be conducted with all practicable speed, with another agency having a substantial interest in the determination of the request or among two or more offices of the Office of Inspector General having a substantial interest in the subject matter of the request.

[49 FR 11165, Mar. 26, 1984. Redesignated and amended at 53 FR 37550, 37552, Sept. 27, 1988; 57 FR 2227; Jan. 21, 1992; 59 FR 14097, Mar. 25, 1994; 67 FR 47217, July 17, 2002]

§ 2002.19 Authority to release records or copies.

Any Assistant Inspector General or an appointed designee is authorized to release any record (or copy) pertaining to activities for which he or she has primary responsibility, unless disclosure is clearly inappropriate under this part. No authorized person may release records for which another officer has primary responsibility without the consent of the officer or his or her designee.

[49 FR 11165, Mar. 26, 1984. Redesignated at 53 FR 37550, Sept. 27, 1988, as amended at 59 FR 14098, Mar. 25, 1994]

§ 2002.21 Authority to deny requests for records and form of denial.

(a) An Assistant Inspector General may deny a request for a record. Any denial will:

(1) Be in writing;

(2) State simply the reasons for the denial;

(3) State that review of the denial by the Inspector General of HUD may be requested;

(4) Set forth the steps for obtaining review consistent with § 2002.25; and

(5) Be signed by the Assistant Inspector General responsible for the denial.

(b) The classes of records authorized to be exempted from disclosure by the Freedom of Information Act (5 U.S.C. 552) are those which concern matters that are:

(1)(i) Specifically authorized under criteria established by an executive order to be kept secret in the interest of national defense or foreign policy; and

(ii) Are in fact properly classified under the cited executive order;

(2) Related solely to the internal personnel rules and practices of HUD;

(3) Specifically exempted from disclosure by statute (other than section 552b of title 5), provided that the statute either:

(i) Requires that the matters be withheld from the public in a manner that leaves no discretion on the issue; or

(ii) Establishes particular criteria for withholding or refers to particular types of matters to be withheld;

(4) Trade secrets and commercial or financial information that are obtained from a person and are privileged or confidential;

(5) Inter-agency or intra-agency memoranda or letters that would not be available by law to a party other than an agency in litigation with HUD;

(6) Personnel and medical files and similar files the disclosure of which would constitute a clearly unwarranted invasion of personal privacy;

(7) Records or information compiled for law enforcement purposes, but only to the extent that the production of such law enforcement records or information:

(i) Could reasonably be expected to interfere with enforcement proceedings;

§ 2002.23

(ii) Would deprive a person of a right to a fair trial or an impartial adjudication;

(iii) Could reasonably be expected to constitute an unwarranted invasion of personal privacy;

(iv) Could reasonably be expected to disclose the identity of a confidential source, including a state, local, or foreign agency or authority, or any private institution which furnished information on a confidential basis, and, in the case of a record or information compiled by a criminal law enforcement authority in the course of a criminal investigation or by an agency conducting a lawful national security intelligence investigation, information furnished by a confidential source;

(v) Would disclose techniques and procedures for law enforcement investigations or prosecutions, or would disclose guidelines for law enforcement investigations or prosecutions if the disclosure could reasonably be expected to risk circumvention of the law; or

(vi) Could reasonably be expected to endanger the life or physical safety of any individual;

(8) Contained in or related to examination, operating, or condition reports prepared by, on behalf of, or for the use of an agency responsible for the regulation or supervision of financial institutions; or

(9) Geological and geophysical information and data, including maps, concerning wells.

(c) With regard to a request for commercial or financial information, predisclosure notification to business submitters is required by Executive Order 12600 (3 CFR, 1987 Comp., p. 235) to afford the business submitter an opportunity to object to disclosure of the requested information.

(d) Any reasonably segregable portion of a record shall be provided to any person requesting the record, after deletion of the portions that are exempt under this section.

[57 FR 2228, Jan. 21, 1992, as amended at 59 FR 14098, Mar. 25, 1994]

§ 2002.23 Effect of denial of request.

Denial of a request shall terminate the authority of the Assistant Inspector General or his or her designee to re-

24 CFR Ch. XII (4-1-11 Edition)

lease or disclose the requested record, which thereafter may not be made available except with express authorization of the Inspector General of HUD.

[49 FR 11165, Mar. 26, 1984. Redesignated at 53 FR 37550, Sept. 27, 1988]

§ 2002.25 Administrative review.

(a) Review is available only from a written denial of a request for a record issued under § 2002.21 and only if a written request for review is filed within 30 days after issuance of the written denial.

(b) A review may be initiated by mailing a request for review to the Inspector General of HUD, Department of Housing and Urban Development, 451 Seventh Street, SW., Room 8256, Washington, DC 20410. Each request for review must contain the following:

(1) A copy of the request, if in writing;

(2) A copy of the written denial issued under § 2002.21; and

(3) A statement of the circumstances, reasons, or arguments advanced in support of disclosure of the original request for the record.

In order to enable the Inspector General of HUD to comply with the time limitations set forth in § 2002.17, both the envelope containing the request for review and the letter itself should clearly indicate that the subject is a Freedom of Information Act request for review.

(c) Review will be made promptly by the Inspector General of HUD on the basis of the written record described in paragraph (b) of this section. Before a denial, the Inspector General will obtain the concurrence of legal counsel for the Office of Inspector General.

(d) The time of receipt for processing of a request for review purposes is the time it is received by the Inspector General of HUD. If a request is misdirected by the requester and is received by one other than the Inspector General, the Office of Inspector General or Department official who receives the request will forward it promptly to the Inspector General and will advise the requester about the delayed time of receipt.

(e) The decision after review will be in writing, will constitute final agency

action on the request, and, if the denial of the request for records is in full or in part upheld, the Inspector General will notify the person making the request of his or her right to seek judicial review under 5 U.S.C. 552(a)(4).

[49 FR 11165, Mar. 26, 1984. Redesignated and amended at 53 FR 37550, 37552, Sept. 27, 1988]

PART 2003—IMPLEMENTATION OF THE PRIVACY ACT OF 1974

Sec.

2003.1 Scope of the part and applicability of other HUD regulations.

2003.2 Definitions.

2003.3 Requests for records.

2003.4 Officials to receive requests and inquiries.

2003.5 Initial denial of access to records.

2003.6 Disclosure of a record to a person other than the individual to whom it pertains.

2003.7 Authority to make law enforcement-related requests for records maintained by other agencies.

2003.8 General exemptions.

2003.9 Specific exemptions.

AUTHORITY: 5 U.S.C. 552a; 5 U.S.C. App. 3 (Inspector General Act of 1978); 42 U.S.C. 3535(d).

SOURCE: 57 FR 62142, Dec. 29, 1992, unless otherwise noted.

§ 2003.1 Scope of the part and applicability of other HUD regulations.

(a) *General.* This part contains the regulations of the Office of Inspector General ("OIG") implementing the Privacy Act of 1974 (5 U.S.C. 552a). The regulations inform the public that the Inspector General has the responsibility for carrying out the requirements of the Privacy Act and for issuing internal OIG orders and directives in connection with the Privacy Act. These regulations apply to all records that are contained in systems of records maintained by the OIG and that are retrieved by an individual's name or personal identifier.

(b) *Applicability of part 16.* In addition to these regulations, the provisions of 24 CFR part 16 apply to the OIG, except that appendix A to part 16 is not applicable. The provisions of this part shall govern in the event of any conflict with the provisions of part 16.

§ 2003.2 Definitions.

For purposes of this part:

Department means the OIG, except that in the context of §§ 16.1(d); 16.11(b) (1), (3), and (4); and 16.12(e), when those sections are incorporated by reference, the term means the Department of Housing and Urban Development.

Privacy Act Officer means an Assistant Inspector General.

Privacy Appeals Officer means the Inspector General.

[59 FR 14098, Mar. 25, 1994]

§ 2003.3 Requests for records.

(a) A request from an individual for an OIG record about that individual which is not contained in an OIG system of records will be considered to be a Freedom of Information Act (FOIA) request and will be processed under 24 CFR part 2002.

(b) A request from an individual for an OIG record about that individual which is contained in an OIG system of records will be processed under both the Privacy Act and the FOIA in order to ensure maximum access under both statutes. This practice will be undertaken regardless of how an individual characterizes the request.

(1) The procedures for inquiries and requirements for access to records under the Privacy Act are more specifically set forth in 24 CFR part 16, except that appendix A to part 16 does not apply to the OIG.

(2) An individual will not be required to state a reason or otherwise justify his or her request for access to a record.

§ 2003.4 Officials to receive requests and inquiries.

Officials to receive requests and inquiries for access to, or correction of, records in OIG systems of records are the Privacy Act Officers described in § 2003.2 of this part. Written requests may be addressed to the appropriate Privacy Act Officer at: Office of Inspector General, Department of Housing and Urban Development, Washington, DC 20410.

[57 FR 62142, Dec. 29, 1992, as amended at 59 FR 14098, Mar. 25, 1994]

§ 2003.5

§ 2003.5 Initial denial of access to records.

(a) Access by an individual to a record about that individual which is contained in an OIG system of records will be denied only upon a determination by the Privacy Act Officer that:

(1) The record was compiled in reasonable anticipation of a civil action or proceeding; or the record is subject to a Privacy Act exemption under § 2003.8 or § 2003.9 of this part; and

(2) The record is also subject to a FOIA exemption under § 2002.21(b) of this chapter.

(b) If a request is partially denied, any portions of the responsive record that can be reasonably segregated will be provided to the individual after deletion of those portions determined to be exempt.

(c) The provisions of 24 CFR 16.6(b) and 16.7, concerning notification of an initial denial of access and administrative review of the initial denial, apply to the OIG, except that:

(1) The final determination of the Inspector General, as Privacy Appeals Officer for the OIG, will be in writing and will constitute final action of the Department on a request for access to a record in an OIG system of records; and

(2) If the denial of the request is in whole or in part upheld, the final determination of the Inspector General will include notice of the right to judicial review.

§ 2003.6 Disclosure of a record to a person other than the individual to whom it pertains.

(a) The OIG may disclose an individual's record to a person other than the individual to whom the record pertains in the following instances:

(1) Upon written request by the individual, including authorization under 24 CFR 16.5(e);

(2) With the prior written consent of the individual;

(3) To a parent or legal guardian of the individual under 5 U.S.C. 552a(h); or

(4) When permitted by the provisions of 5 U.S.C. 552a(b) (1) through (12).

(b) [Reserved]

24 CFR Ch. XII (4-1-11 Edition)

§ 2003.7 Authority to make law enforcement-related requests for records maintained by other agencies.

(a) The Inspector General is authorized by written delegation from the Secretary of HUD and under the Inspector General Act to make written requests under 5 U.S.C. 552a(b)(7) for transfer of records maintained by other agencies which are necessary to carry out an authorized law enforcement activity under the Inspector General Act.

(b) The Inspector General delegates the authority under paragraph (a) of this section to the following OIG officials:

(1) Deputy Inspector General;

(2) Assistant Inspector General for Audit;

(3) Assistant Inspector General for Investigation; and

(4) Assistant Inspector General for Management and Policy.

(c) The officials listed in paragraph (b) of this section may not redelegate the authority described in paragraph (a) of this section.

§ 2003.8 General exemptions.

(a) The systems of records entitled "Investigative Files of the Office of Inspector General," "Hotline Complaint Files of the Office of Inspector General," "Name Indices System of the Office of Inspector General," and "AutoInvestigation of the Office of Inspector General" consist, in part, of information compiled by the OIG for the purpose of criminal law enforcement investigations. Therefore, to the extent that information in these systems falls within the scope of exemption (j)(2) of the Privacy Act, 5 U.S.C. 552a(j)(2), these systems of records are exempt from the requirements of the following subsections of the Privacy Act, for the reasons stated in paragraphs (a)(1) through (6) of this section.

(1) From subsection (c)(3), because release of an accounting of disclosures to an individual who is the subject of an investigation could reveal the nature and scope of the investigation and could result in the altering or destruction of evidence, improper influencing of witnesses, and other evasive actions that could impede or compromise the investigation.

(2) From subsection (d)(1), because release of investigative records to an individual who is the subject of an investigation could interfere with pending or prospective law enforcement proceedings, constitute an unwarranted invasion of the personal privacy of third parties, reveal the identity of confidential sources, or reveal sensitive investigative techniques and procedures.

(3) From subsection (d)(2), because amendment or correction of investigative records could interfere with pending or prospective law enforcement proceedings, or could impose an impossible administrative and investigative burden by requiring the OIG to continuously retrograde its investigations attempting to resolve questions of accuracy, relevance, timeliness and completeness.

(4) From subsection (e)(1), because it is often impossible to determine relevance or necessity of information in the early stages of an investigation. The value of such information is a question of judgment and timing; what appears relevant and necessary when collected may ultimately be evaluated and viewed as irrelevant and unnecessary to an investigation. In addition, the OIG may obtain information concerning the violation of laws other than those within the scope of its jurisdiction. In the interest of effective law enforcement, the OIG should retain this information because it may aid in establishing patterns of unlawful activity and provide leads for other law enforcement agencies. Further, in obtaining evidence during an investigation, information may be provided to the OIG which relates to matters incidental to the main purpose of the investigation but which may be pertinent to the investigative jurisdiction of another agency. Such information cannot readily be identified.

(5) From subsection (e)(2), because in a law enforcement investigation it is usually counterproductive to collect information to the greatest extent practicable directly from the subject thereof. It is not always feasible to rely upon the subject of an investigation as a source for information which may implicate him or her in illegal activities. In addition, collecting informa-

tion directly from the subject could seriously compromise an investigation by prematurely revealing its nature and scope, or could provide the subject with an opportunity to conceal criminal activities, or intimidate potential sources, in order to avoid apprehension.

(6) From subsection (e)(3), because providing such notice to the subject of an investigation, or to other individual sources, could seriously compromise the investigation by prematurely revealing its nature and scope, or could inhibit cooperation, permit the subject to evade apprehension, or cause interference with undercover activities.

(b) [Reserved]

[57 FR 62142, Dec. 29, 1992, as amended at 65 FR 50904, Aug. 21, 2000]

§ 2003.9 Specific exemptions.

(a) The systems of records entitled "Investigative Files of the Office of Inspector General," "Hotline Complaint Files of the Office of Inspector General," "Name Indices System of the Office of Inspector General," and "AutoInvestigation of the Office of Inspector General" consist, in part, of investigatory material compiled by the OIG for law enforcement purposes. Therefore, to the extent that information in these systems falls within the coverage of exemption (k)(2) of the Privacy Act, 5 U.S.C. 552a(k)(2), these systems of records are exempt from the requirements of the following subsections of the Privacy Act, for the reasons stated in paragraphs (a) (1) through (4) of this section.

(1) From subsection (c)(3), because release of an accounting of disclosures to an individual who is the subject of an investigation could reveal the nature and scope of the investigation and could result in the altering or destruction of evidence, improper influencing of witnesses, and other evasive actions that could impede or compromise the investigation.

(2) From subsection (d)(1), because release of investigative records to an individual who is the subject of an investigation could interfere with pending or prospective law enforcement proceedings, constitute an unwarranted invasion of the personal privacy of third parties, reveal the identity of

Pt. 2004

confidential sources, or reveal sensitive investigative techniques and procedures.

(3) From subsection (d)(2), because amendment or correction of investigative records could interfere with pending or prospective law enforcement proceedings, or could impose an impossible administrative and investigative burden by requiring the OIG to continuously retrograde its investigations attempting to resolve questions of accuracy, relevance, timeliness and completeness.

(4) From subsection (e)(1), because it is often impossible to determine relevance or necessity of information in the early stages of an investigation. The value of such information is a question of judgment and timing; what appears relevant and necessary when collected may ultimately be evaluated and viewed as irrelevant and unnecessary to an investigation. In addition, the OIG may obtain information concerning the violation of laws other than those within the scope of its jurisdiction. In the interest of effective law enforcement, the OIG should retain this information because it may aid in establishing patterns of unlawful activity and provide leads for other law enforcement agencies. Further, in obtaining evidence during an investigation, information may be provided to the OIG which relates to matters incidental to the main purpose of the investigation but which may be pertinent to the investigative jurisdiction of another agency. Such information cannot readily be identified.

(b) The systems of records entitled "Investigative Files of the Office of Inspector General," "Hotline Complaint Files of the Office of Inspector General," "Name Indices System of the Office of Inspector General," and "Autoinvestigation of the Office of Inspector General" consist in part of investigatory material compiled by the OIG for the purpose of determining suitability, eligibility, or qualifications for Federal civilian employment or Federal contracts, the release of which would reveal the identity of a source who furnished information to the Government under an express promise that the identity of the source would be held in confidence. Therefore,

24 CFR Ch. XII (4-1-11 Edition)

to the extent that information in these systems fall within the coverage of exemption (k)(5) of the Privacy Act, 5 U.S.C. 552a(k)(5), these systems of records are exempt from the requirements of subsection (d)(1), because release would reveal the identity of a source who furnished information to the Government under an express promise of confidentiality. Revealing the identity of a confidential source could impede future cooperation by sources, and could result in harassment or harm to such sources.

[57 FR 62142, Dec. 29, 1992, as amended at 65 FR 50904, Aug. 21, 2000]

PART 2004—SUBPOENAS AND PRODUCTION IN RESPONSE TO SUBPOENAS OR DEMANDS OF COURTS OR OTHER AUTHORITIES

Subpart A—General Requirements

Sec.

- 2004.1 Scope and purpose.
- 2004.2 Applicability.
- 2004.3 Definitions.

Subpart B—Office of Inspector General Subpoenas

- 2004.10 Service of an Office of Inspector General subpoena.

Subpart C—Requests for Testimony and Production of Documents

- 2004.20 General prohibition.
- 2004.21 Factors OIG will consider.
- 2004.22 Filing requirements for demands or requests for documents or testimony.
- 2004.23 Service of subpoenas or requests.
- 2004.24 Processing demands or requests.
- 2004.25 Final determination.
- 2004.26 Restrictions that apply to testimony.
- 2004.27 Restrictions that apply to released records.
- 2004.28 Procedure in the event of an adverse ruling.
- 2004.29 Fees.

AUTHORITY: Inspector General Act of 1978, as amended (5 U.S.C. app.) and 42 U.S.C. 3535(d).

SOURCE: 68 FR 3366, Jan. 23, 2003, unless otherwise noted.

Subpart A—General Requirements

§ 2004.1 Scope and purpose.

(a) This part sets forth the policy for service of a subpoena issued by the Office of Inspector General (OIG), and policies and procedures that you must follow when you submit a demand or request to an employee of the OIG to produce official records and information, or provide testimony relating to official information, in connection with a legal proceeding. You must comply with these requirements when you request the release or disclosure of official records and information.

(b) The OIG intends these provisions to:

(1) Promote economy and efficiency in its programs and operations;

(2) Minimize the possibility of involving OIG in controversial issues not related to OIG's functions;

(3) Maintain OIG's impartiality among private litigants where OIG is not a named party; and

(4) Protect sensitive, confidential information and the deliberative processes of OIG.

(c) In providing for these requirements, OIG does not waive the sovereign immunity of the United States.

(d) This part provides guidance for the internal operations of OIG. This part does not create any right or benefit, substantive or procedural, that a party may rely upon in any legal proceeding against the United States.

§ 2004.2 Applicability.

This subpart applies to demands and requests to employees for factual or expert testimony relating to official information, or for production of official records or information, in legal proceedings in which HUD or OIG is not a named party. However, this subpart does not apply to:

(a) Demands upon or requests for an OIG employee to testify as to facts or events that are unrelated to his or her official duties or that are unrelated to the functions of OIG;

(b) Requests for the release of records under the Freedom of Information Act, 5 U.S.C. 552, or the Privacy Act, 5 U.S.C. 552a; and

(c) Congressional demands and Congressional requests for testimony or records.

§ 2004.3 Definitions.

Counsel means the Counsel to the Inspector General.

Demand means a subpoena, or an order or other command of a court or other competent authority, for the production, disclosure, or release of records or for the appearance and testimony of an OIG employee that is issued in a legal proceeding.

Legal proceeding means any matter before a court of law, administrative board or tribunal, commission, administrative law judge, hearing officer, or other body that conducts a legal or administrative proceeding. Legal proceeding includes all phases of litigation.

OIG means the Office of Inspector General, U.S. Department of Housing and Urban Development.

OIG employee or employee means:

(1) Any current or former officer or employee of OIG;

(2) Any other individual hired through contractual agreement by or on behalf of OIG or who has performed or is performing services under such an agreement for OIG; and

(3) Any individual who served or is serving in any consulting or advisory capacity to OIG, whether formal or informal.

Records or official records or information means:

(1) All documents and materials that are OIG agency records under the Freedom of Information Act, 5 U.S.C. 552;

(2) All other documents and materials contained in OIG files; and

(3) All other information or materials acquired by an OIG employee in the performance of his or her official duties or because of his or her official status.

Request means any informal request, by whatever method, for the production of records and information or for testimony that has not been ordered by a court or other competent authority.

Testimony means any written or oral statements, including depositions, answers to interrogatories, affidavits, declarations, recorded interviews, and

§ 2004.10

statements made by an individual in connection with a legal proceeding.

Subpart B—Office of Inspector General Subpoenas

§ 2004.10 Service of an Office of Inspector General subpoena.

Service of a subpoena issued by OIG may be accomplished as follows:

(a) *Personal service.* Service may be made by delivering the subpoena to the person to whom it is addressed. If the subpoena is addressed to a corporation or other business entity, it may be served upon an employee of the corporation or entity. Service made to an employee, agent, or legal representative of the addressee shall constitute service upon the addressee.

(b) *Service by mail.* Service may also be made by mailing the subpoena, certified mail—return receipt requested, to the addressee at his or her last known business or personal address.

Subpart C—Requests for Testimony and Production of Documents

§ 2004.20 General prohibition.

No employee may produce official records and information or provide any testimony relating to official information in response to a demand or request without the prior, written approval of the Inspector General or the Counsel.

§ 2004.21 Factors OIG will consider.

The Counsel or Inspector General, in their discretion, may grant an employee permission to testify on matters relating to official information, or produce official records and information, in response to a demand or request. Among the relevant factors that the Inspector General or the Counsel may consider in making this decision are whether:

- (a) The purposes of this part are met;
- (b) OIG has an interest in the decision that may be rendered in the legal proceeding;
- (c) Allowing such testimony or production of records would assist or hinder OIG in performing its statutory duties or use OIG resources where responding to the request will interfere

24 CFR Ch. XII (4–1–11 Edition)

with the ability of OIG employees to do their work;

(d) The records or testimony can be obtained from other sources;

(e) The demand or request is unduly burdensome or otherwise inappropriate under the applicable rules of discovery or the rules of procedure governing the case or matter in which the demand or request arose;

(f) Disclosure would violate or be inconsistent with a statute, Executive Order, or regulation;

(g) Disclosure would reveal confidential or privileged information, trade secrets, or similar, confidential commercial, or financial information;

(h) Disclosure would impede or interfere with an ongoing law enforcement investigation or proceedings, or compromise constitutional rights;

(i) Disclosure would result in OIG appearing to favor one litigant over another;

(j) Disclosure relates to documents that were produced by another agency;

(k) The demand or request is in conformance with all other applicable rules;

(l) The demand or request is sufficiently specific to be answered; and

(m) For any other good cause.

§ 2004.22 Filing requirements for demands or requests for documents or testimony.

You must comply with the following requirements whenever you issue demands or requests to an OIG employee for official records and information or testimony.

(a) Your request must be in writing and must be submitted to the Counsel. If you serve a subpoena on OIG or on an OIG employee before submitting a written request and receiving a final determination from the Counsel, OIG will oppose the subpoena on grounds that your request was not submitted in accordance with this subpart.

(b) Your written request must contain the following information:

- (1) The caption of the legal proceeding, docket number, and name and address of the court or other authority involved;

(2) A copy of the complaint or equivalent document setting forth the assertions in the case and any other pleading or document sufficient to show relevance;

(3) A list of categories of records sought, a detailed description of how the information sought is relevant to the issues in the legal proceeding, and a specific description of the substance of the testimony or records sought;

(4) A statement as to how the need for the information outweighs the need to maintain any confidentiality of the information and outweighs the burden on OIG to produce the records or provide testimony;

(5) A statement indicating that the information sought is not available from another source, from other persons or entities, or from the testimony of someone other than an OIG employee, such as a retained expert;

(6) If testimony is requested, the intended use of the testimony, a general summary of the desired testimony, and a showing that no document could be provided and used in lieu of testimony;

(7) A description of all prior decisions, orders, or pending motions in the case that bear upon the relevance of the requested records or testimony;

(8) The name, address, and telephone number of counsel to each party in the case; and

(9) An estimate of the amount of time that the requester and other parties will require with each OIG employee for time spent by the employee to prepare for testimony, in travel, and for attendance in the legal proceeding.

(c) The OIG reserves the right to require additional information to complete your request where appropriate.

(d) Your request should be submitted at least 30 days before the date that records or testimony are required. Requests submitted less than 30 days before records or testimony are required must be accompanied by a written explanation stating the reasons for the late request and the reasons for expedited processing.

(e) Failure to cooperate in good faith to enable the Counsel to make an informed decision may serve as the basis for a determination not to comply with your request.

§ 2004.23 Service of subpoenas or requests.

Subpoenas or requests for official records or information or testimony must be served on the Counsel to the Inspector General, Office of Inspector General, U.S. Department of Housing and Urban Development, 451 Seventh Street, SW, Room 8260, Washington, DC 20410-4500.

§ 2004.24 Processing demands or requests.

(a) After service of a demand or request to testify, the Counsel will review the demand or request and, in accordance with the provisions of this subpart, determine whether, or under what conditions, to authorize the employee to testify on matters relating to official information and/or to produce official records and information.

(b) The OIG will process requests in the order in which they are received. Absent exigent or unusual circumstances, OIG will respond within 30 days from the date that we receive all information necessary to the evaluation of the demand or request. The time for response will depend upon the scope of the request.

(c) The Counsel may grant a waiver of any procedure described in this subpart where a waiver is considered necessary to promote a significant interest of OIG, HUD, and the United States, or for other good cause.

§ 2004.25 Final determination.

The Counsel makes the final determination on demands and requests to employees for production of official records and information or testimony. All final determinations are within the sole discretion of the Counsel. The Counsel will notify the requester of the final determination, the reasons for the grant or denial of the demand or request, and any conditions that the Counsel may impose on the release of records or information, or on the testimony of an OIG employee.

§ 2004.26 Restrictions that apply to testimony.

(a) The Counsel may impose conditions or restrictions on the testimony of OIG employees including, for example, limiting the areas of testimony or

§ 2004.27

requiring the requester and other parties to the legal proceeding to agree that the transcript of the testimony will be kept under seal or will only be used or made available in the particular legal proceeding for which testimony was requested. The Counsel may also require a copy of the transcript of testimony at the requester's expense.

(b) The OIG may offer the employee's written declaration in lieu of testimony.

(c) If authorized to testify pursuant to this part, an employee may testify as to facts within his or her personal knowledge, but, unless specifically authorized to do so by the Counsel, the employee shall not:

(1) Disclose confidential or privileged information;

(2) Testify as to facts when the Counsel determines such testimony would not be in the best interest of OIG, HUD and the United States; or

(3) Testify as an expert or opinion witness with regard to any matter arising out of the employee's official duties or the functions of OIG. This provision does not apply to requests from the United States for expert or opinion testimony.

§ 2004.27 Restrictions that apply to released records.

(a) The Counsel may impose conditions or restrictions on the release of official records and information, including the requirement that parties to the proceeding obtain a protective order or execute a confidentiality agreement to limit access and any further disclosure. The terms of the protective order or of a confidentiality agreement must be acceptable to the Counsel. In cases where protective orders or confidentiality agreements have already been executed, OIG may condition the release of official records and information on an amendment to the existing protective order or confidentiality agreement.

(b) If the Counsel so determines, original OIG records may be presented for examination in response to a demand or request, but they are not to be presented as evidence or otherwise used in a manner by which they could lose their identity as official OIG records,

24 CFR Ch. XII (4-1-11 Edition)

nor are they to be marked or altered. In lieu of the original records, certified copies will be presented for evidentiary purposes.

§ 2004.28 Procedure in the event of an adverse ruling.

(a) *Opportunity to review adverse ruling.* Any person aggrieved by a decision made by the Counsel under this part denying a request for documents or testimony, or restricting the release of documents or testimony, may seek review of that decision pursuant to paragraph (c) of this section.

(b) *Procedure in the event of conflicting court order.* If the Inspector General or Counsel declines to approve a demand for records or testimony and a court or other authority rules that the demand must be complied with irrespective of the instructions from the OIG not to produce the material or disclose the information sought, the employee or former employee upon whom the demand has been made shall respectfully decline to comply with the demand, citing *United States ex rel. Touhy v. Ragen*, 340 U.S. 462 (1951).

(c) *Procedure—(1) Notice of intention to petition for review.* A party or any person aggrieved by the decision made pursuant to this part denying or restricting the release of documents or testimony may seek review of the decision by filing a written Notice of Intention to Petition for Review (Notice) within five business days of the date of this decision. The Notice shall identify the petitioner, the adverse decision, and any dates (such as deposition, hearing, or court dates) that are significant to the party. The Notice shall be served in accordance with § 2004.23.

(2) *Petition for review.* Within five business days of the filing of a Notice, the person or party seeking review shall file a Petition for Review (Petition) containing a clear and concise statement of the issues to be reviewed and the reasons why the review is appropriate. The petition shall include exceptions to any findings of fact or conclusions of law made, together with supporting reasons and arguments for such exceptions based on appropriate citations to such record or law as may exist. These reasons may be stated in

Office of Inspector General, HUD

§ 2004.29

summary form. Decisions on the Petition may be made by either the Inspector General or the Counsel and shall become the final decisions of the OIG. The Petition will be served in accordance with §2004.23.

(d) *Prerequisite to judicial review.* Pursuant to Section 704 of the Administrative Procedure Act, 5 U.S.C. 704, a petition to the agency for review of a decision made under the authority of this part is a prerequisite to the seeking of judicial review of the final decision.

[70 FR 36791, June 24, 2005]

§ 2004.29 Fees.

(a) *Generally.* The Counsel may condition the production of records or appearance for testimony upon advance payment of a reasonable estimate of the costs to OIG.

(b) *Fees for records.* Fees for producing records will include fees for searching, reviewing, and duplicating records, costs of attorney time spent in reviewing the demand or request, and expenses generated by materials and equipment used to search for, produce, and copy the responsive information. Costs for employee time will be calculated on the basis of the hourly pay of the employee (including all pay, allowance, and benefits). Fees for duplication will be the same as those

charged by OIG in its Freedom of Information Act Regulations at 24 CFR part 2002.

(c) *Witness fees.* Fees for attendance by a witness will include fees, expenses, and allowances prescribed by the court's rules. If no such fees are prescribed, witness fees will be determined based upon the rule of the federal district court closest to the location where the witness will appear. Such fees will include cost of time spent by the witness to prepare for testimony, in travel, and for attendance in the legal proceeding.

(d) *Payment of fees.* You must pay any applicable witness fees for current OIG employees and any records certification fees by submitting to the Counsel a check or money order for the appropriate amount made payable to the Treasury of the United States. In the case of testimony by former OIG employees, you must pay applicable fees directly to the former employee in accordance with applicable statutes.

(e) *Waiver or reduction of fees.* The Counsel, in his or her sole discretion, may, upon a showing of reasonable cause, waive or reduce any fees in connection with the testimony or production of records. Additionally, fees will not be assessed if the total charge would be \$10.00 or less.

CHAPTER XV—EMERGENCY MORTGAGE
INSURANCE AND LOAN PROGRAMS,
DEPARTMENT OF HOUSING AND URBAN
DEVELOPMENT

<i>Part</i>		<i>Page</i>
2700	Emergency Homeowners' Loan Program	107

PART 2700—EMERGENCY HOMEOWNERS' LOAN PROGRAM

Subpart A—General

- Sec.
2700.1 Purpose.
2700.5 Definitions.
2700.10 Determination of emergency.

Subpart B—Eligibility

- 2700.101 Eligible properties.
2700.105 Eligible institutions.
2700.110 Eligible homeowners.

Subpart C—Emergency Assistance

- 2700.201 Types and terms of emergency assistance.
2700.205 Emergency assistance amount.
2700.210 Finance charges.

Subpart D—Mortgage Insurance

- 2700.301 Loan applications.
2700.305 Conditions of insurance.
2700.310 Fees.
2700.315 Insurance premium.
2700.320 Servicing.
2700.325 Termination of mortgage insurance.
2700.330 Default.
2700.335 Claims.
2700.340 Payment of insurance benefits.
2700.345 Administrative reports and examinations.
2700.350 Sale, assignment, and pledge of insured loan.

Subpart E—Direct Loans

- 2700.401 Participation by lending institutions.
2700.405 Application for loans.
2700.410 Transmittal of Funds.
2700.415 Fees.
2700.420 Servicing.
2700.425 Default.
2700.430 Collection.
2700.435 Payment to HUD.
2700.440 Administrative report and examinations.

AUTHORITY: 12 U.S.C. 2707; 42 U.S.C. 3535(d)

SOURCE: 76 FR 11950, Mar. 4, 2011, unless otherwise noted.

EFFECTIVE DATE NOTE: At 76 FR 11950, Mar. 4, 2011, Chapter XV, consisting of part 2700 was added to title 24, effective Apr. 4, 2011.

Subpart A—General

§ 2700.1 Purpose.

This part establishes the Emergency Homeowners' Loan Program, a standby

program authorized by the Emergency Homeowners Relief Act of 1975, as amended, to prevent widespread mortgage foreclosures and distress sales of homes resulting from a homeowner's substantial reduction in income due to temporary involuntary loss of employment or underemployment resulting from adverse economic conditions or medical condition. Under this program, HUD is authorized to provide relief in the forms of emergency mortgage relief loans, advances of credit, or emergency mortgage relief payments to struggling unemployed or underemployed homeowners to help them avoid foreclosure, provided the homeowner meets certain specific conditions. HUD may provide such relief through approved institutions, including lending institutions, or intermediaries designated by HUD. HUD is also authorized to allow assistance under this program to be administered by a State that has an existing program that is determined by HUD to provide substantially similar assistance to homeowners.

§ 2700.5 Definitions.

For purposes of this part, the following terms are defined as follows:

Act means the Emergency Homeowners' Relief Act, title I of the Emergency Housing Act of 1975 (12 U.S.C. 2701), as amended by the Dodd-Frank Wall Street Reform and Consumer Protection Act (Pub. L. 111–203, approved July 21, 2010).

Area Median Income (AMI) means the median family income for the metropolitan statistical area (MSA) or statewide nonmetropolitan area, as most recently determined and published by HUD, where the property meeting the eligibility requirements in § 2700.1 is located.

Delinquent mortgage means a first-lien mortgage secured by property meeting the eligibility requirements in § 2700.101, where the homeowner and holder of the delinquent mortgage have certified that circumstances, including delinquent payments of at least 3 months, make it probable there will be a foreclosure and that the homeowner is in need of emergency mortgage relief.

Emergency assistance includes, but is not limited to, an emergency mortgage

§ 2700.10

24 CFR Ch. XV (4-1-11 Edition)

relief loan, advance of credit, or emergency mortgage relief payment provided to an eligible homeowner, as authorized by the Act, and in accordance with the requirements of this part.

Event refers to the involuntary unemployment or underemployment status of the homeowner due to adverse economic conditions or medical condition. See definition of *involuntary unemployment or underemployment due to adverse economic conditions or adverse medical condition*.

Finance charge means the cost of credit as determined in 12 CFR 226.4, a section in Regulation Z of the Federal Reserve System's regulations on Truth in Lending.

Homeowner means an individual with a mortgage on the individual's principal residence, in which the individual resides, and who meets the requirements of § 2700.10 and who is in need of emergency assistance pursuant to this part.

HUD means the Department of Housing and Urban Development.

Income means the cumulative annual adjusted gross income of the homeowner, co-makers, and co-signers on the note secured by the delinquent mortgage and the other mortgagors on the delinquent mortgage.

Involuntary unemployment or underemployment due to adverse economic conditions or adverse medical condition means the status of a homeowner who was working, either as a wage or salaried worker or through self-employment, is currently involuntarily unemployed or underemployed due to adverse economic conditions or medical condition, and is unable to meet the homeowner's monthly mortgage payments.

Lender means a lending institution that provides an emergency mortgage relief loan or advance of credit insured under this part.

Monthly income means one-twelfth of the *income*, as *income* is defined in this section.

Monthly mortgage payment means the monthly amount of principal, interest, taxes, ground rents, hazard insurance, and mortgage insurance premiums due to be paid under a homeowner's delinquent mortgage.

Mortgage means any mortgage, deed of trust, executor land sales contract, conditional sales contract, or other form of security and the obligation secured by a one- to four-family dwelling that is either real estate or a manufactured home. *Mortgage* includes a mortgage on a condominium unit and a security interest in stock in a housing cooperative.

Mortgagee means a lending institution that is the holder of the delinquent mortgage. The *mortgagee* may be the same entity as the *Lender*.

Secretary means the Secretary of Housing and Urban Development.

Servicer means any entity which services an emergency loan made by HUD under this part.

Servicing institution means any entity that services the delinquent mortgage. The servicing institution may also be the same entity as the *Lender* or *Servicer*.

Term of monthly payments means a period of monthly payments provided under this part not to exceed 24 months. Eligible homeowners may receive assistance for up to 12 months, and in accordance with criteria established by HUD, and such assistance may be extended once for up to 12 additional months, but in no case may monthly payments under this part exceed 24 months. The eligible homeowner may also receive assistance in an amount up to the statutory ceiling of \$50,000, whichever occurs first.

§ 2700.10 Determination of emergency.

(a) The Secretary is authorized to provide emergency assistance under the Emergency Homeowners' Loan Program when:

(1) Funds have been explicitly appropriated or made available for this program and the statute making funding available directs the Secretary to commence making emergency assistance available to homeowners; or

(2) The Secretary has announced that this program has been activated and provides the reasons for activation of this program in a document published in the FEDERAL REGISTER.

(b) If the Emergency Homeowners' Loan Program is activated pursuant to paragraph (a) of this section, HUD

shall publish a document in the FEDERAL REGISTER announcing the activation of the program and inviting one or more categories of eligible institutions, as defined in § 2700.105, to participate in the Emergency Homeowners' Loan Program, to provide such emergency assistance as HUD may designate from among the eligible types of emergency relief provided in § 2700.201, and provide such other information regarding participation in the program, as necessary and appropriate.

Subpart B—Eligibility

§ 2700.101 Eligible properties.

(a) In order to qualify for an emergency assistance under this part, the property of the homeowner seeking assistance must:

(1) Be a single-family residence in a one-to-four unit building, or a condominium or a housing cooperative or a manufactured home;

(2) Be the principal residence of the homeowner, which means it is the residence where the homeowner resides;

(3) Be subject to a delinquent mortgage, as defined in § 2700.5, but not, unless otherwise specified by HUD, subject to liens having a total outstanding principal balance, as specified by HUD;

(4) Have flood insurance, pursuant to the National Flood Insurance Program, in an amount equal to at least the initial principal amount of the emergency loan, if the property is located in an area that has been identified by HUD at least one year before the origination of the emergency loan as an area having special flood hazards; and

(5) Meet such other requirements as may be prescribed by HUD for reasons including, but not limited to, the particular economic circumstances in which emergency assistance is being made available, or the type of emergency assistance being made available.

(b) A property that meets the requirements of paragraph (a) of this section is referred to as the mortgaged property.

§ 2700.105 Eligible institutions.

(a) *Eligible lending institutions.* (1) In order to participate in the Emergency Homeowners' Loan Program as a lender or servicer, a lending institution

must be approved as a mortgagee by the Federal Housing Administration in accordance with the applicable requirements in 24 CFR part 203, and meet such other requirements as may be prescribed by HUD as necessary or appropriate for participation in the Emergency Homeowners' Loan Program.

(2) Approval of a lending institution pursuant to paragraph (a)(1) of this section may be withdrawn at any time by notice from HUD for the following reasons:

(i) The transfer of an insured emergency mortgage relief loan or advance of credit to a nonapproved entity;

(ii) The failure of a lending institution to submit the required annual audit report of its financial condition within 75 days of the close of its fiscal year, or within such other period as may be specified by HUD; or

(iii) The failure of a lending institution to comply with the regulations of this part, or such additional program policies or requirements as specified by HUD. Withdrawal of a lending institution's approval shall not affect the insurance on the emergency mortgage relief loans or advances of credit accepted for insurance.

(3) All approved lending institutions are responsible for servicing of emergency mortgage relief loans and advances of credit in accordance with acceptable mortgage practices of prudent lending institutions and pursuant to 24 CFR part 203.

(b) *Eligible participating organizations.* HUD may delegate authority with respect to the processing of emergency mortgage relief payments as may be appropriate to facilitate the prompt and efficient implementation of assistance under the Emergency Homeowners' Loan Program.

(c) *States with comparable programs.* HUD is authorized to allow funding for the Emergency Homeowners' Loan Program to be administered by a State that has an existing program that is determined by HUD to provide substantially similar assistance to homeowners. After such determination is made, any State that HUD authorizes to administer funding under this program shall not be required to modify its own program to comply with the provisions of this part.

§ 2700.110

§ 2700.110 Eligible homeowners.

In order to qualify for an emergency assistance under this part, the homeowner must:

(a) Have a total pre-Event income that is equal to, or less than, 120 percent of the area median income (AMI).

(b) Have incurred a substantial reduction of income as evidenced by current monthly income that is at least 15 percent lower than the pre-Event income, as a result of involuntary unemployment or underemployment due to adverse economic or medical conditions, or such other reduction in income as may be specified by HUD.

(c) Have a delinquent mortgage, as defined in § 2700.5;

(d) Be financially unable at the time of application for emergency relief under this part to make full monthly mortgage payments;

(e) Have a reasonable likelihood to resume full monthly mortgage payments, and repay the emergency assistance pursuant to the terms and conditions under which the emergency assistance was made available to the homeowner. The standard for meeting this requirement is debt-to-income (DTI) ratio. The homeowner must have a back-end ratio of below 55 percent (principal, interest, taxes, insurance, revolving and fixed installment debt divided by total monthly income), or such other DTI as may be specified by HUD. For this DTI calculation, income will be measured at the pre-Event level.

(f) Have not received other emergency assistance pursuant to this part;

(g) Have been notified that the mortgagee intends to foreclose;

(h) Produce a certification from the mortgagee in which the homeowner also certifies that circumstances make it probable that the mortgagee will foreclose on the homeowner's delinquent mortgage; and

(i) Meet such other requirements as may be prescribed by HUD for reasons including, but not limited to, the particular economic circumstances in which emergency assistance is being made available, or the type of emergency assistance being made available.

24 CFR Ch. XV (4-1-11 Edition)

Subpart C—Emergency Assistance

§ 2700.201 Types and terms of emergency assistance.

(a) *Types of emergency assistance.* Emergency assistance may be provided to an eligible homeowner in the form of emergency mortgage relief loans and advances of credit, or in the form of emergency mortgage relief payments. In accordance with § 2700.205, the aggregate amount of assistance provided for any eligible homeowner shall not exceed \$50,000 or extend beyond the term of monthly payments, as defined in § 2700.5.

(1) *Emergency mortgage loans and advances.* HUD is authorized, upon such terms and conditions as specified by HUD, to insure financial institutions, which HUD finds to be qualified by experience and facilities and approves as eligible for insurance, against losses that they may sustain as a result of providing emergency mortgage relief loans or advances of credit made under this part.

(2) *Emergency mortgage relief payments.* (i) HUD is authorized to make emergency relief payments under such terms and conditions as HUD may prescribe. Emergency mortgage relief payments may be provided:

(A) As payment of 100 percent of an eligible homeowner's delinquent mortgage arrearages, which may include mortgage principal, interest, insurance, taxes, hazard insurance, ground rent, homeowners' assessment fees or condominium fees, and foreclosure-related legal fees and late payments, in accordance with such terms and conditions as prescribed by HUD; and

(B) As monthly payments due on such delinquent mortgage, for up to a period not to exceed the term of monthly payments, as provided in § 2700.5.

(ii) Such emergency mortgage relief payments may be repayable in the form of a declining balance, non-recourse, zero-interest, subordinate loan secured by the same property securing the delinquent mortgage, for a term of up to 7 years.

(3) *Direct payments to mortgagees.* HUD is authorized to make direct emergency mortgage relief payments to a

Emergency Mortgage Ins. and Loan Programs, HUD

§ 2700.201

mortgagee that elects not to participate in the Emergency Homeowners' Loan program as an approved mortgagee on behalf of homeowners:

(i) Whose mortgages are held by such mortgagee; and

(ii) Who meet the requirements of § 2700.110.

(b) *Terms and conditions of assistance.* Emergency mortgage relief loans and advances of credit made and insured under this part, and emergency mortgage relief payments made under this part, shall be repayable by the homeowner upon such terms and conditions prescribed by HUD, except that:

(1) The rate of interest on any emergency mortgage relief loan or advance of credit insured shall be fixed for the life of the emergency mortgage relief loan or advance of credit and shall not exceed the rate of interest that is generally charged for mortgages on single-family housing insured by the Federal Housing Administration under title II of the National Housing Act at the time such emergency mortgage relief loan or advance of credit is made;

(2) No interest shall be charged on interest that is deferred on an emergency mortgage relief loan or advance of credit made under this part. In establishing rates, terms, and conditions for emergency mortgage relief loans or advances of credit, HUD shall take into account a homeowner's ability to repay such emergency mortgage relief loan or advance of credit;

(3) Any mortgage insurance premium charge or charges for any emergency mortgage relief loan or advance of credit made under this part shall not exceed an amount equivalent to one-half of one percent per annum of the principal obligation of such emergency mortgage relief loan or advance of credit outstanding at any one time;

(4) Unless otherwise specified by HUD for a given fiscal year, the homeowner's contribution to the monthly mortgage payment will be set at 31 percent of monthly income at the time of the application for assistance, but in no instance will such contribution to the monthly mortgage payment be less than \$25 per month;

(5) The homeowner may repay the emergency mortgage relief loan or advance of credit in full, without penalty,

by lump sum or by installment payments at any time before the emergency mortgage relief loan or advance of credit becomes due and payable; and

(6) With respect to the emergency mortgage relief payments repayable in the form of a declining balance, non-recourse, zero-interest, subordinate loan as described § 2700.201(a)(2), no payment shall be due by the homeowner during the term of the loan so long as the homeowner remains current in his or her monthly homeowner contribution payments on the delinquent mortgage. If the homeowner meets this requirement, the balance due shall decline by such percentage as may be designated by HUD, until the loan is fully satisfied.

(c) *Termination of emergency assistance.* Emergency assistance provided to a homeowner shall be terminated and the homeowner shall resume full responsibility for meeting the first mortgage payments if any of the following occur:

(1) The maximum loan amount (\$50,000) has been provided to the homeowner;

(2) The homeowner fails to report changes in employment status or income within 15 days of the change;

(3) The homeowner's income increases to 85 percent or more of its pre-Event income level, or such other percentage as may be prescribed by HUD;

(4) The homeowner sells the mortgaged property or refinances the mortgaged property for cash-out;

(5) The homeowner defaults on the monthly homeowner's contribution payment on the delinquent mortgage;

(6) The homeowner has exhausted the full term of monthly payments, as defined in § 2700.5; or

(7) Such other event as may be specified by HUD.

(d) *Deferral of commencement of repayment.* HUD may authorize the deferral of the commencement of the repayment of an emergency mortgage relief loan or advance of credit or emergency mortgage relief payments made under this part until one year following the date of the last disbursement of the proceeds of the emergency mortgage relief loan or advance of credit or emergency mortgage relief payments,

§ 2700.205

or for such longer period as HUD determines would further the purpose of the Emergency Homeowners' Loan Program.

§ 2700.205 Emergency assistance amount.

(a) Emergency assistance to an eligible homeowner may be made available in an amount up to the amount of the principal, interest, taxes, ground rents, hazard insurance, and mortgage insurance premiums due under the homeowner's mortgage and such other costs as may be specified by HUD. The amount of emergency assistance provided to the homeowner shall be an amount that is determined by HUD to be reasonably necessary to supplement such amount as the homeowner is capable of contributing toward the homeowner's delinquent first mortgage payments, except that the aggregate amount of emergency relief provided to any homeowner shall not exceed \$50,000, including any fees allowed under §§ 2700.310(a) and 2700.415(a).

(b) Arrearage payments and monthly assistance payments may be made either with the proceeds of an insured emergency mortgage relief loan or advance of credit or with emergency mortgage relief payments for up to full term of the monthly payments, as defined in § 2700.5.

(c) Unless otherwise authorized by HUD, the lender or servicer shall not approve an emergency mortgage loan or advance of credit when the outstanding balance, including delinquent interest, of the delinquent mortgage when added to the other liens against the mortgaged property, plus the maximum emergency mortgage relief loan that may be advanced to the homeowner under this part, exceeds the value of the mortgaged property. (In determining the value of the property, the lender or servicer may rely upon previously obtained appraisals or other determinations of value of the property and need not obtain a current appraisal.)

§ 2700.210 Finance charges.

The maximum permissible finance charge, exclusive of fees and charges as provided in §§ 2700.310, and 2700.415, which may directly or indirectly be

24 CFR Ch. XV (4-1-11 Edition)

paid to or collected by the lender or the servicer in connection with an emergency mortgage relief loan or advance-of-credit transaction, shall not exceed simple interest on the outstanding principal balance at the annual interest rate for FHA-insured home mortgages at such time the emergency mortgage relief loan or advance of credit is originated. Additionally, no points or discounts of any kind may be assessed or collected in connection with an emergency mortgage relief loan or advance-of-credit transaction.

Subpart D—Mortgage Insurance

§ 2700.301 Loan applications.

(a) Lending institutions approved by HUD for participation in the Emergency Homeowners' Loan Program are authorized to accept, process, and approve applications for emergency mortgage relief loans or advances of credit under this part under such terms and conditions as HUD may prescribe.

(b) An approved lender may make an emergency mortgage relief loan or advances of credit on the terms specified in this part if the lender is satisfied that the application meets all of the relevant requirements of this part. The lender shall prepare a note, loan agreement, if any, and mortgage as required by HUD, which the lender shall record against the property securing the delinquent mortgage upon the execution of those documents.

(c) Except as may be otherwise specified by HUD, on the last working day of the month during which an emergency mortgage relief loan or advance of credit is closed, the lender shall submit to HUD an application for an insured emergency mortgage relief loan or advance of credit on such form as prescribed by HUD, signed by the mortgagor and holder of the mortgage and that certifies that:

(1) The lender, homeowner, and property meet the eligibility requirements of this part;

(2) Circumstances (such as the volume of delinquent loans in the investor's portfolio likely to remain uncured) make it probable that there

Emergency Mortgage Ins. and Loan Programs, HUD

§ 2700.315

would be a foreclosure of the delinquent mortgage if the emergency mortgage relief were not provided to the homeowner;

(3) The homeowner is in need of such emergency assistance and the mortgagee has indicated to the homeowner its intention to foreclose on the delinquent mortgage; and

(4) The first disbursement of the principal amount of the emergency mortgage relief loan or advance of credit has been paid or credited to the homeowner's account with the servicing institution.

§ 2700.305 Conditions of insurance.

(a) When the requirements of this part have been met, the lender's mortgage insurance coverage under its mortgage insurance contract will apply to a particular loan as of the date of closing, if the lender has not exceeded the mortgage insurance authority allocation which HUD has given the lender.

(b) From the effective date of the emergency mortgage relief loan or advance of credit until the termination of the insurance with respect to that loan, the lender shall be bound by the provisions of this part as such provisions relate to the emergency mortgage relief loan or advance of credit.

§ 2700.310 Fees.

(a) The lender may collect from the homeowner during the year following the origination of the emergency mortgage relief loan or advance of credit the following fees or charges in conjunction with providing the emergency mortgage relief loan or advance of credit:

(1) A charge to compensate the lender for expenses incurred in originating and closing the emergency relief loan, including preparation of a note, loan agreement, if any, and a mortgage in a form satisfactory for recordation, the total charge not to exceed such amount as specified by HUD;

(2) Actual amounts charged by State or local governments or government officials for recording fees and recording taxes or other charges incident to making the emergency relief loan or advance of credit;

(3) An amount equal to the annual premium for flood insurance required

by § 2700.101(a)(4) (the lender shall pay the homeowner's flood insurance premium for that year to the extent it collects such an amount); and

(4) An amount equal to the annual mortgage insurance premium required under § 2700.315.

(b) Subsequent to the year following the origination of the emergency mortgage relief loan or advance of credit and up to the termination of mortgage insurance under § 2700.325, the lender may collect from the homeowner the following fees and charges in connection with the emergency relief loan: An amount equal to the mortgage insurance premium required under § 2700.315.

§ 2700.315 Insurance premium.

(a) At such times as may be prescribed by HUD, the participating lender shall pay to HUD a mortgage insurance premium equal to one-half of one percent of the average outstanding balance of the emergency mortgage relief loan or advance of credit, during the previous calendar year, of all emergency mortgage relief loans or advances of credit that the lender held or serviced during that period pursuant to this part.

(b) With respect to the payment provided for in paragraph (a) of this section, the lender shall submit a breakdown of the mortgage insurance premium in the form prescribed by HUD.

(c) If a mortgage securing an emergency mortgage relief loan or advance of credit is sold, assigned, or pledged pursuant to § 2700.350, any adjustments of the mortgage insurance premium already paid in connection with a mortgage securing an emergency mortgage relief loan or advance of credit shall be made by and between the lenders, except that any unpaid installments of the mortgage insurance premium shall be paid to HUD by the purchasing lender.

(d) There shall be no refund or abatement of any portion of the insurance premium except when the mortgage insurance premium relates to an emergency mortgage relief loan or advance of credit found to be ineligible. However, no refund shall be made unless a claim is denied by HUD or the ineligibility is reported by the lender promptly upon discovery and an application

§ 2700.320

for refund is made. In no event shall charges be refunded when the application for refund is not made until after the emergency mortgage relief loan or advance of credit is paid in full.

§ 2700.320 Servicing.

Servicing functions for the emergency mortgage relief loan or advance of credit during the period that the emergency loan or advance is insured shall be performed by the lender or the servicing institution acting for the lender. The lender is responsible for proper servicing, even though the actual servicing is not performed by the lender.

§ 2700.325 Termination of mortgage insurance.

The mortgage insurance coverage and the insured lender's obligation to remit mortgage insurance premiums to HUD with respect to an emergency mortgage relief loan or advance of credit shall be terminated upon whichever of the following first occurs:

- (a) The emergency mortgage relief loan or advance of credit is paid in full;
- (b) The lender acquires the mortgaged property securing the emergency mortgage relief loan or advance of credit and notifies HUD that no claim for insurance benefits has been or will be made;
- (c) The homeowner and the lender jointly request termination; or
- (d) The lender files an insurance claim pursuant to § 2700.335.

§ 2700.330 Default.

- (a) If the homeowner fails to make a scheduled payment or perform any other obligation required for the type of emergency assistance provided under this part, the homeowner shall be deemed to be in default.
- (b) For purposes of this subpart, the date of default shall be the earliest of:
 - (1) 30 days after the first day the homeowner is delinquent on the mortgage securing the emergency mortgage relief loan or advance of credit, if the delinquency remains uncorrected;
 - (2) The date the property securing the emergency mortgage relief loan or advance of credit is sold before full repayment of the emergency loan or advance of credit; and

24 CFR Ch. XV (4-1-11 Edition)

(3) The date a lien superior to that securing the emergency mortgage relief loan or advance of credit is foreclosed.

(c) If, after default and prior to the foreclosure of the mortgage securing the emergency mortgage relief loan or advance of credit, the homeowner cures the default, the emergency loan or advance of credit shall be treated as if a default had not occurred, provided the homeowner pays the lender for any expenses the lender incurred in connection with the lender's attempt to collect on the emergency mortgage relief loan or advance of credit.

§ 2700.335 Claims.

(a) Claims for mortgage insurance for reimbursement for loss on an emergency mortgage relief loan or advance of credit shall be made in such form and provide such information as specified by HUD.

(b) Claims may be filed upon the homeowner's default on the emergency mortgage relief loan or advance of credit.

(c) When the homeowner defaults on the emergency mortgage relief loan or advance of credit, the lender may elect to:

(1) Proceed against the mortgage securing the emergency mortgage relief loan or advance of credit or attempt to collect on the note and then make a claim under its insurance contract if there is any net loss, or

(2) Make a claim under its mortgage insurance contract without proceeding against the security or the note.

(d) Except as may be otherwise specified by HUD, mortgage insurance claims shall be filed on the last working day of the month, no later than 90 days after the date of default, unless the lender proceeds against the mortgage securing the emergency relief loan or advance of credit, in which case the filing shall be no later than one year after the date of default, or such other time period as approved by HUD. If at the time of default or at any time subsequent to the default, a person primarily or secondarily liable for the repayment of a loan is a person in "military service", as such term is defined in the Servicemembers Civil Relief Act

Emergency Mortgage Ins. and Loan Programs, HUD

§ 2700.350

of 2003 (Pub. L. 108-189, approved December 19, 2003) (formerly known as Soldier's and Sailor's Civil Relief Act of 1940) (50 U.S.C. app. 501-594), the lender shall refrain from instituting foreclosure proceedings during the period in which the servicemember is in military service and 3 months thereafter and that period shall be excluded in computing the time within which a claim for insurance benefits under this subpart may be made.

(e) An insured lender will be reimbursed for its losses on emergency mortgage relief loans and advances of credit made in accordance with this part, in an amount equal to 90 percent of the sum of the following:

(1) The unpaid principal amount of the emergency mortgage relief loan or advance of credit less the amount recovered;

(2) The uncollected interest earned up to the date of claim;

(3) Uncollected court costs, including fees paid for issuing, serving, and filing summonses;

(4) Attorney's fees actually paid, not exceeding the lesser of:

(i) 25 percent of the amount collected by the attorney on the defaulted note, or

(ii) 15 percent of the balance due on the note; and

(5) Expenses actually incurred in recording assignments of mortgages to the United States of America, up to such amount as specified by HUD.

(f) The note and any mortgage held or judgment taken by the claimant must be assigned in its entirety and if any claim has been filed in bankruptcy, insolvency, or probate proceedings, such claim shall be likewise assigned to the United States of America. The assignment shall be in the form approved by HUD.

§ 2700.340 Payment of insurance benefits.

Upon receipt of a claim for insurance benefits that meets the requirements of § 2700.335 and the other provisions of this part, HUD shall make a payment of insurance benefits in cash to the claimant in an amount equal to the amount specified in § 2700.335(e).

§ 2700.345 Administrative reports and examinations.

At any time, HUD may call upon an insured lender for such reports as are deemed to be necessary in connection with the regulations of this part and may inspect the books or accounts of the lender as they pertain to the emergency mortgage relief loans or advances of credit that are insured pursuant to this subpart.

§ 2700.350 Sale, assignment, and pledge of insured loan.

(a) No lender may sell or otherwise dispose of any insured emergency mortgage relief loan or advance of credit except pursuant to this section.

(b) An insured emergency mortgage relief loan or advance of credit may be sold to a lending institution eligible under § 2700.105. Upon such sale, both the seller and the buyer shall notify HUD within 30 days of the date of sale.

(c) When an insured emergency mortgage relief loan or advance of credit is sold to another lending institution eligible under § 2700.105, the buyer shall thereupon succeed to all the rights and become bound by all the obligations of the seller under the contract of insurance under this part, and the seller shall be released from its obligations under the contract of insurance.

(d) An assignment, pledge, or transfer of an insured emergency mortgage relief loan or advance of credit not constituting an actual transfer of legal title may be made by the lender to another eligible lending institution, subject to the following conditions:

(1) The assignor, pledgor, or transferor shall remain the lender for purposes of the contract of insurance under this part.

(2) HUD shall have no obligation to recognize or deal with any party other than that lender with respect to the rights, benefits, and obligations of the lender under the contract of insurance. Notice to or approval of HUD is not required in connection with assignments, pledges, or transfers pursuant to this subpart.

Subpart E—Direct Loans

§ 2700.401 Participation by lending institutions.

A lending institution eligible under § 2700.105 is authorized, except as may be otherwise prescribed by HUD, to accept, process, and approve applications for direct loans under this subpart in the form specified. That authority includes making determinations relating to the eligibility of the direct loan, homeowner, and property, pursuant to the provisions of this part. Direct loans, however, may be made pursuant to this part only when the investor cannot make an emergency loan under subpart D of this part for good cause, as determined by HUD.

§ 2700.405 Application for loans.

(a) The agreement to process an application for a direct loan shall constitute an acceptance of the lending institution of the responsibility to act as the servicer of HUD with respect to that particular application. The servicer shall make a loan on behalf of HUD on the terms specified in subpart C of this part if the lending institution is satisfied that the application meets all of the requirements of this part.

(b) The servicer shall prepare a note, loan agreement, if any, and mortgage in the form specified in § 2700.201. The servicer shall record the mortgage upon the closing of the loan. The servicer shall make the first advance of the loan, as provided for in § 2700.201(d), using its own funds.

(c) On the last working day of the month during which the loan is closed, the servicer shall submit to HUD a copy of the application signed by the agent and the homeowner certifying that: The agent, homeowner, and property qualify under subpart B of this part; circumstances (such as the volume of delinquent loans in the investor's portfolio likely to remain uncured) make it probable that there would be a foreclosure if emergency mortgage relief were not given; the homeowner is in need of such relief; the investor has indicated to the homeowner its intention to foreclose; and the first advance of the emergency loan has been paid or credited to the home-

owner's account with the servicing institution.

§ 2700.410 Transmittal of funds.

(a) When the requirements of this part have been met, HUD will transmit to the servicer, pursuant to the monthly accounting prescribed in § 2700.420, the emergency loan proceeds, as long as the agent has not exceeded the lending authority allocation that HUD has given the servicer pursuant to § 2700.10(c).

(b) When the investor is the servicer, the transmittal of funds under this section shall be conditioned upon the investor's agreement, for a period up to one month after the last advance under the emergency mortgage relief loan, to refrain from instituting foreclosure proceedings against the homeowner, as long as the amount delinquent at the time of the origination of the emergency mortgage relief loan, excluding interest thereon, does not increase, unless HUD's prior approval is obtained.

(c) From the processing of the application until the satisfaction of the debt or the final accounting pursuant to § 2700.435, the servicer shall be bound by the provisions of this part with respect to a particular direct loan.

§ 2700.415 Fees.

(a) The servicer may collect from the homeowner during the year following the origination of the emergency loan the following fees or charges in conjunction with providing the emergency loan:

(1) A charge to compensate the servicer for expenses incurred in originating and closing the emergency mortgage relief loan, including preparation of a note, loan agreement, if any, and a mortgage in a form satisfactory for recordation, the total charge not to exceed such amount as may be specified by HUD;

(2) Actual amounts charged by State or local governments or government officials for recording fees and recording taxes or other charges incident to making the emergency loan;

(3) An amount equal to the annual premium for flood insurance required by § 2700.101(c) (the servicer shall pay

Emergency Mortgage Ins. and Loan Programs, HUD

§ 2700.430

the homeowner's flood insurance premium for that year to the extent it collects such an amount); and

(4) An amount equal to the annual premium required under § 2700.420(d).

(b) Subsequent to the year following the origination of the emergency mortgage relief loan and up to the final accounting on the emergency mortgage relief loan under § 2700.435, the servicer may collect from the homeowner the fees and charges as provided in this section.

§ 2700.420 Servicing.

(a) Servicing functions during the period that the emergency mortgage relief loan is outstanding shall be performed by the servicer.

(b) On the same day each month while the servicer is servicing emergency mortgage relief loans for HUD, the servicer shall submit a monthly accounting, in the form prescribed by HUD, for all of the emergency mortgage relief loans that it services. The accounting shall list the amount of funds that it advanced under emergency mortgage relief loans during the previous calendar month. In addition, the accounting shall list the amount paid to the servicer under the emergency mortgage relief loans serviced by the servicer during the previous calendar month.

(c) If, pursuant to the monthly accounting, the amount HUD owes the servicer exceeds the amount the servicer owes HUD, HUD shall remit the difference to the servicers, as long as HUD finds the accounting in order. If, pursuant to the monthly accounting, the amount the servicer owes HUD exceeds the amount HUD owes the servicer, the servicer shall remit the difference when the servicer submits the monthly accounting to HUD.

(d) At such times as may be prescribed by HUD, the servicer, in addition to making its monthly accounting, shall pay to HUD a premium equal to one-half of one percent of the average outstanding balance during the previous calendar year of all the emergency mortgage relief loans it serviced during that period. That payment shall be accompanied by a breakdown of the premium in the form prescribed by HUD.

§ 2700.425 Default.

(a) If the homeowner fails to make any payment or to perform any other obligation under the mortgage securing the emergency mortgage relief loan, the homeowner shall be deemed to be delinquent on such loan.

(b) For purposes of this subpart, the date of default shall be the earliest of:

(1) 30 days after the first day the homeowner is delinquent on the emergency mortgage relief loan, if the delinquency remains uncorrected:

(2) The date the mortgaged property is sold before full repayment of the emergency mortgage relief loan; and

(3) The date a lien superior to that securing the emergency mortgage relief loan is foreclosed.

(c) If, after default and prior to the foreclosure of the mortgage securing the emergency mortgage relief loan, the homeowner cures the default, the emergency mortgage relief loan shall be treated as if the default had not occurred, provided the homeowner pays the servicer for any expenses the servicer incurred in connection with the servicer's attempt to collect on the loan.

§ 2700.430 Collection.

(a) If a homeowner defaults on an emergency mortgage loan, the servicer shall elect:

(1) To wait while the Department of Justice proceeds against the mortgage securing the emergency mortgage relief loan or attempts to collect on the note, and then to make an accounting and payment to HUD, as provided in § 2700.435, or

(2) To make an accounting and payment, as provided in § 2700.435, without waiting while the Department of Justice proceeds against the mortgage or note.

(b) If pursuant to paragraph (a) of this section, the servicer elects to make an accounting without waiting while the Department of Justice proceeds against the mortgage or note, the servicer at the time of that accounting will have the option of purchasing the emergency loan and underlying mortgage for a price equal to 0.5 times the unpaid principal balance.

§ 2700.435

24 CFR Ch. XV (4-1-11 Edition)

§ 2700.435 Payment to HUD.

(a) Before the expiration of the period of 90 days after the date of default, or such other time period as HUD approves, the servicer shall transmit to HUD on the last working day of the month the complete credit and collection file pertaining to the emergency mortgage relief loan.

(b) At the same time the servicer makes the transmittal as provided in paragraph (a) of this section, it shall share the loss on the emergency mortgage relief loan by making a payment to HUD in an amount equal to 10 percent of the sum of:

(1) The unpaid principal amount of the emergency mortgage relief loan, less the amount recovered; and

(2) The uncollected interest earned up to the date of the final accounting. Accompanying that payment shall be a final accounting of the emergency mortgage relief loan, in the form specified by HUD, and the note and mortgage executed in connection with the emergency mortgage relief loan.

(c) Notwithstanding the provisions of paragraph (b) of this section, in the event that the aggregate loss borne by HUD reaches such percent, as specified in the FEDERAL REGISTER document activating the Emergency Homeowners' Loan Program, of the aggregate amount advanced by the servicer on behalf of HUD under this subpart, the

servicer shall bear the burden of any loss in excess of that such percent by making an appropriate payment to HUD within the time period specified in paragraph (a) of this section.

(d) If at the time of default or at any time subsequent to default, a person primarily or secondarily liable for the repayment of an emergency loan is a person in "military service", as such term is defined in the Servicemembers Civil Relief Act of 2003 (Pub. L. 108-189, approved December 19, 2003) (formerly known as Soldier's and Sailor's Civil Relief Act of 1940) (50 U.S.C. app. 501-594), the period the servicemember is in military service and 3 months thereafter and that period shall be excluded in computing the time within which an accounting and payment are to be made pursuant to paragraph (a) of this section.

§ 2700.440 Administrative report and examinations.

HUD may at any time call for a report from any servicer on the delinquency status of the emergency mortgage relief loans serviced by the servicer on behalf of HUD or call for such reports as may be deemed to be necessary in connection with the provisions of this part, or HUD may inspect the books or accounts of the servicer as they pertain to those emergency mortgage relief loans.

CHAPTER XX—OFFICE OF ASSISTANT
SECRETARY FOR HOUSING—FEDERAL
HOUSING COMMISSIONER, DEPARTMENT OF
HOUSING AND URBAN DEVELOPMENT

<i>Part</i>		<i>Page</i>
3280	Manufactured home construction and safety standards	121
3282	Manufactured home procedural and enforcement regulations	216
3284	Manufactured housing program fee	269
3285	Model manufactured home installation standards ..	269
3286	Manufactured home installation program	312
3288	Manufactured home dispute resolution program	335
3500	Real Estate Settlement Procedures Act	344
3800	Investigations in consumer regulatory programs ...	407

PART 3280—MANUFACTURED HOME CONSTRUCTION AND SAFETY STANDARDS

Subpart A—General

- Sec.
3280.1 Scope.
3280.2 Definitions.
3280.3 Manufactured home procedural and enforcement regulations and consumer manual requirements.
3280.4 Incorporation by reference.
3280.5 Data plate.
3280.6 Serial number.
3280.7 Excluded structures.
3280.8 Waivers.
3280.9 Interpretative bulletins.
3280.10 Use of alternative construction.
3280.11 Certification label.

Subpart B—Planning Considerations

- 3280.101 Scope.
3280.102 Definitions.
3280.103 Light and ventilation.
3280.104 Ceiling heights.
3280.105 Exit facilities; exterior doors.
3280.106 Exit facilities; egress windows and devices.
3280.107 Interior privacy.
3280.108 Interior passage.
3280.109 Room requirements.
3280.110 Minimum room dimensions.
3280.111 Toilet compartments.
3280.112 Hallways.
3280.113 Glass and glazed openings.

Subpart C—Fire Safety

- 3280.201 Scope.
3280.202 Definitions.
3280.203 Flame spread limitations and fire protection requirements.
3280.204 Kitchen cabinet protection.
3280.205 Carpeting.
3280.206 Firestopping.
3280.207 Requirements for foam plastic thermal insulating materials.
3280.208 Smoke alarm requirements.
3280.209 Fire testing.

Subpart D—Body and Frame Construction Requirements

- 3280.301 Scope.
3280.302 Definitions.
3280.303 General requirements.
3280.304 Materials.
3280.305 Structural design requirements.
3280.306 Windstorm protection.
3280.307 Resistance to elements and use.
3280.308 Formaldehyde emission controls for certain wood products.
3280.309 Health Notice on formaldehyde emissions.

Subpart E—Testing

- 3280.401 Structural load tests.
3280.402 Test procedure for roof trusses.
3280.403 Standard for windows and sliding glass doors used in manufactured homes.
3280.404 Standard for egress windows and devices for use in manufactured homes.
3280.405 Standard for swinging exterior passage doors for use in manufactured homes.
3280.406 Air chamber test method for certification and qualification of formaldehyde emission levels.

Subpart F—Thermal Protection

- 3280.501 Scope.
3280.502 Definitions.
3280.503 Materials.
3280.504 Condensation control and installation of vapor retarders.
3280.505 Air infiltration.
3280.506 Heat loss/heat gain.
3280.507 Comfort heat gain.
3280.508 Heat loss, heat gain and cooling load calculations.
3280.509 Criteria in absence of specific data.
3280.510 Heat loss certificate.
3280.511 Comfort cooling certificate and information.

Subpart G—Plumbing Systems

- 3280.601 Scope.
3280.602 Definitions.
3280.603 General requirements.
3280.604 Materials.
3280.605 Joints and connections.
3280.606 Traps and cleanouts.
3280.607 Plumbing fixtures.
3280.608 Hangers and supports.
3280.609 Water distribution systems.
3280.610 Drainage systems.
3280.611 Vents and venting.
3280.612 Tests and inspection.

Subpart H—Heating, Cooling and Fuel Burning Systems

- 3280.701 Scope.
3280.702 Definitions.
3280.703 Minimum standards.
3280.704 Fuel supply systems.
3280.705 Gas piping systems.
3280.706 Oil piping systems.
3280.707 Heat producing appliances.
3280.708 Exhaust duct system and provisions for the future installation of a clothes dryer.
3280.709 Installation of appliances.
3280.710 Venting, ventilation and combustion air.
3280.711 Instructions.
3280.712 Marking.
3280.713 Accessibility.
3280.714 Appliances, cooling.
3280.715 Circulating air systems.

Subpart I—Electrical Systems

- 3280.801 Scope.
- 3280.802 Definitions.
- 3280.803 Power supply.
- 3280.804 Disconnecting means and branch-circuit protective equipment.
- 3280.805 Branch circuits required.
- 3280.806 Receptacle outlets.
- 3280.807 Fixtures and appliances.
- 3280.808 Wiring methods and materials.
- 3280.809 Grounding.
- 3280.810 Electrical testing.
- 3280.811 Calculations.
- 3280.812 Wiring of expandable units and dual units.
- 3280.813 Outdoor outlets, fixtures, air conditioning equipment, etc.
- 3280.814 Painting of wiring.
- 3280.815 Polarization.
- 3280.816 Examination of equipment for safety.

Subpart J—Transportation

- 3280.901 Scope.
- 3280.902 Definitions.
- 3280.903 General requirements for designing the structure to withstand transportation shock and vibration.
- 3280.904 Specific requirements for designing the transportation system.

AUTHORITY: 42 U.S.C. 3535(d), 5403, and 5424.

SOURCE: 40 FR 58752, Dec. 18, 1975, unless otherwise noted. Redesignated at 44 FR 20679, Apr. 6, 1979.

Subpart A—General**§ 3280.1 Scope.**

This standard covers all equipment and installations in the design, construction, transportation, fire safety, plumbing, heat-producing and electrical systems of manufactured homes which are designed to be used as dwelling units. This standard seeks to the maximum extent possible to establish performance requirements. In certain instances, however, the use of specific requirements is necessary.

[58 FR 55002, Oct. 25, 1993]

§ 3280.2 Definitions.

Definitions in this subpart are those common to all subparts of the standard and are in addition to the definitions provided in individual parts. The definitions are as follows:

Approved, when used in connection with any material, appliance or construction, means complying with the

requirements of the Department of Housing and Urban Development.

Bay window—a window assembly whose maximum horizontal projection is not more than two feet from the plane of an exterior wall and is elevated above the floor level of the home.

Certification label means the approved form of certification by the manufacturer that, under § 3280.8, is permanently affixed to each transportable section of each manufactured home manufactured for sale in the United States.

Dwelling unit means one or more habitable rooms which are designed to be occupied by one family with facilities for living, sleeping, cooking and eating.

Equipment includes materials, appliances, devices, fixtures, fittings or accessories both in the construction of, and in the fire safety, plumbing, heat-producing and electrical systems of manufactured homes.

Federal manufactured home construction and safety standard means a reasonable standard for the construction, design, and performance of a manufactured home which meets the needs of the public including the need for quality, durability, and safety.

Installations means all arrangements and methods of construction, as well as fire safety, plumbing, heat-producing and electrical systems used in manufactured homes.

Labeled means a label, symbol or other identifying mark of a nationally recognized testing laboratory, inspection agency, or other organization concerned with product evaluation that maintains periodic inspection of production of labeled equipment or materials, and by whose labeling is indicated compliance with nationally recognized standards or tests to determine suitable usage in a specified manner.

Length of a manufactured home means its largest overall length in the traveling mode, including cabinets and other projections which contain interior space. Length does not include bay windows, roof projections, overhangs, or eaves under which there is no interior space, nor does it include drawbars, couplings or hitches.

Listed or certified means included in a list published by a nationally recognized testing laboratory, inspection agency, or other organization concerned with product evaluation that maintains periodic inspection of production of listed equipment or materials, and whose listing states either that the equipment or material meets nationally recognized standards or has been tested and found suitable for use in a specified manner.

Manufacturer means any person engaged in manufacturing or assembling manufactured homes, including any person engaged in importing manufactured homes for resale.

Manufactured home means a structure, transportable in one or more sections, which in the traveling mode is 8 body feet or more in width or 40 body feet or more in length or which when erected on-site is 320 or more square feet, and which is built on a permanent chassis and designed to be used as a dwelling with or without a permanent foundation when connected to the required utilities, and includes the plumbing, heating, air-conditioning, and electrical systems contained in the structure. This term includes all structures that meet the above requirements except the size requirements and with respect to which the manufacturer voluntarily files a certification pursuant to § 3282.13 of this chapter and complies with the construction and safety standards set forth in this part 3280. The term does not include any self-propelled recreational vehicle. Calculations used to determine the number of square feet in a structure will include the total of square feet for each transportable section comprising the completed structure and will be based on the structure's exterior dimensions measured at the largest horizontal projections when erected on site. These dimensions will include all expandable rooms, cabinets, and other projections containing interior space, but do not include bay windows. Nothing in this definition should be interpreted to mean that a manufactured home necessarily meets the requirements of HUD's Minimum Property Standards (HUD Handbook 4900.1) or that it is automatically eligible for financing under 12 U.S.C. 1709(b).

Manufactured home construction means all activities relating to the assembly and manufacture of a manufactured home including, but not limited to, those relating to durability, quality and safety.

Manufactured home safety means the performance of a manufactured home in such a manner that the public is protected against any unreasonable risk of the occurrence of accidents due to the design or construction of such manufactured home, or any unreasonable risk of death or injury to the user or to the public if such accidents do occur.

Registered Engineer or Architect means a person licensed to practice engineering or architecture in a state and subject to all laws and limitations imposed by the state's Board of Engineering and Architecture Examiners and who is engaged in the professional practice of rendering service or creative work requiring education, training and experience in engineering sciences and the application of special knowledge of the mathematical, physical and engineering sciences in such professional or creative work as consultation, investigation, evaluation, planning or design and supervision of construction for the purpose of securing compliance with specifications and design for any such work.

Secretary means the Secretary of Housing and Urban Development, or an official of the Department delegated the authority of the Secretary with respect to title VI of Pub. L. 93-383.

State includes each of the several States, the District of Columbia, the Commonwealth of Puerto Rico, Guam, the Virgin Islands, the Canal Zone, and American Samoa.

Width of a manufactured home means its largest overall width in the traveling mode, including cabinets and other projections which contain interior space. Width does not include bay windows, roof projections, overhangs, or eaves under which there is no interior space.

[40 FR 58752, Dec. 18, 1975, as amended at 42 FR 960, Jan. 4, 1977. Redesignated at 44 FR 20679, Apr. 6, 1979, as amended at 47 FR 28092, June 29, 1982; 58 FR 55002, Oct. 25, 1993; 61 FR 5216, Feb. 9, 1996; 72 FR 27228, May 14, 2007]

§ 3280.3

§ 3280.3 Manufactured home procedural and enforcement regulations and consumer manual requirements.

A manufacturer must comply with the requirements of this part 3280, part 3282 of this chapter, and 42 U.S.C. 5416.

[61 FR 18250, Apr. 25, 1996]

§ 3280.4 Incorporation by reference.

(a) The specifications, standards and codes of the following organizations are incorporated by reference in 24 CFR part 3280 (this Standard) pursuant to 5 U.S.C. 552(a) and 1 CFR part 51 as though set forth in full. The incorporation by reference of these standards has been approved by the Director of the Federal Register. Reference standards have the same force and effect as this Standard (24 CFR part 3280) except that whenever reference standards and this Standard are inconsistent, the requirements of this Standard prevail to the extent of the inconsistency.

(b) The abbreviations and addresses of organizations issuing the referenced standards appear below. Reference standards which are not available from their producer organizations may be obtained from the Office of Manufactured Housing and Regulatory Functions, Manufactured Housing and Construction Standards Division, U.S. Department of Housing and Urban Development, 451 Seventh Street, SW., room B-133, Washington, DC 20410.

AA—Aluminum Association, 900 19th Street NW., suite 300, Washington, DC 20006.
AAMA—American Architectural Manufacturers Association, 1540 East Dundee Road, Palatine, Illinois 60067
AFPA [previously (N)FPA]—American Forest and Paper Association, 1250 Connecticut Avenue, NW., Washington, DC 20036 [previously named (N)FPA-National Forest Products Association]
AGA—American Gas Association, 8501 East Pleasant Valley Road, Cleveland, Ohio 44131
AISC—American Institute of Steel Construction, One East Wacker Drive, Chicago, IL 60601
AISI—American Iron and Steel Institute, 1101 17th Street, NW., Washington, DC 20036
AITC—American Institute of Timber Construction, 11818 SE Mill Plain Blvd., suite 415, Vancouver, Washington 98684
ANSI—American National Standards Institute, 1430 Broadway, New York, New York 10018

24 CFR Ch. XX (4-1-11 Edition)

APA—American Plywood Association, P.O. Box 11700, Tacoma, Washington 98411
ARI—Air Conditioning and Refrigeration Institute, 1501 Wilson Blvd., 6th Floor, Arlington, VA 22209-2403
ASCE—American Society of Civil Engineers, 345 East 47th Street, New York, New York 10017-2398
ASHRAE—American Society of Heating, Refrigeration and Air Conditioning Engineers, 1791 Tulle Circle, NE., Atlanta, Georgia 30329
ASME—American Society of Mechanical Engineers, 345 East 47th Street, New York, New York 10017
ASSE—American Society of Sanitary Engineering, P.O. Box 40362, Bay Village, Ohio 44140
ASTM—American Society for Testing and Materials, 1916 Race Street, Philadelphia, Pennsylvania 19103
CISPI—Cast Iron Soil Pipe Institute, 5959 Shallowford Road, suite 419, Chattanooga, TN 37421
DOC—U.S. Department of Commerce, National Institute of Standards and Technology, Office of Engineering Standards, room A-166, Technical Building, Washington, DC 20234
FS—Federal Specifications, General Services Administration, Specifications Branch, room 6039, GSA Building, 7th and D Streets, SW., Washington, DC 20407
HPVA (previously HPMA)—Hardwood Plywood and Veneer Association, P.O. Box 2789, Reston, VA 22090 (previously named HPMA Hardwood Plywood Manufacturers Association)
HUD-FHA—Department of Housing and Urban Development, 451 Seventh Street, SW., Washington, DC 20410
HUD User, 11491 Sunset Hills Road, Reston, VA 20190-5254
IAPMO—International Association of Plumbing and Mechanical Officials, 20001 Walnut Drive South, Walnut, CA 91784-2825
IITRI—IIT Research Institute, 10 West 35th Street, Chicago, IL 60616
MIL—Military Specifications and Standards, Naval Publications and Forms Center, 5801 Tabor Avenue, Philadelphia, Pennsylvania 19120
NEMA—National Electrical Manufacturers Association, 1300 North 17th Street, Suite 1847, Rosslyn, VA 22209
NER—International Code Council Evaluation Service [Previously known as National Evaluation Service], 5360 Workman Mill Road, Whittier, CA 90601-0543
NFPA—National Fire Protection Association, Batterymarch Park, Quincy, MA 02269
NPA—National Particleboard Association, 18928 Premiere Court, Gaithersburg, MD 20879
NFRFC—National Fenestration Rating Council, 8984 Georgia Avenue, Suite 320, Silver Spring, MD 20910

Office of Asst. Sec. for Housing, HUD

§ 3280.6

NSF—National Sanitation Foundation, P.O. Box 1468, Ann Arbor, MI 48105

NWWDA—National Wood Window and Door Association, 1400 E. Touhy Avenue, suite G-54, Des Plaines, IL 60018

SAE—Society of Automotive Engineers, 400 Commonwealth Drive, Warrendale, Pennsylvania 15096

SJI—Steel Joist Institute, 1205 48th Avenue North, suite A, Myrtle Beach, SC 29577

TPI—Truss Plate Institute, 583 D'Onofrio Drive, suite 200, Madison, Wisconsin 53719

UL—Underwriters' Laboratories, Inc., 333 Pfingsten Road, Northbrook, Illinois 60062

WDMA—Window and Door Manufacturers Association [Previously known as the National Wood Window and Door Association, NWWDA], 1400 East Touhy Avenue, Des Plaines, IL 60018

(c) The Department will enforce the listed editions of material incorporated by reference into this standard. If a later edition is to be enforced, the Department will publish a notice of change in the FEDERAL REGISTER.

[47 FR 49385, Nov. 1, 1982, as amended at 52 FR 47553, Dec. 15, 1987; 58 FR 55002, Oct. 25, 1993; 59 FR 15113, Mar. 31, 1994; 70 FR 72042, Nov. 30, 2005]

§ 3280.5 Data plate.

Each manufactured home shall bear a data plate affixed in a permanent manner near the main electrical panel or other readily accessible and visible location. Each data plate shall be made of material that will receive typed information as well as preprinted information, and which can be cleaned of ordinary smudges or household dirt without removing information contained on the data plate; or the data plate shall be covered in a permanent manner with materials that will make it possible to clean the data plate of ordinary dirt and smudges without obscuring the information. Each data plate shall contain not less than the following information:

(a) The name and address of the manufacturing plant in which the manufactured home was manufactured.

(b) The serial number and model designation of the unit, and the date the unit was manufactured.

(c) The statement:

This manufactured home is designed to comply with the Federal Manufactured Home Construction and Safety Standards in force at the time of manufacture.

(d) A list of the certification label(s) number(s) that are affixed to each transportable manufactured section under § 3280.8.

(e) A list of major factory-installed equipment, including the manufacturer's name and the model designation of each appliance.

(f) Reference to the roof load zone and wind load zone for which the home is designed and duplicates of the maps as set forth in § 3280.305(c). This information may be combined with the heating/cooling certificate and insulation zone map required by §§ 3280.510 and 3280.511. The Wind Zone Map on the Data Plate shall also contain the statement:

This home has not been designed for the higher wind pressures and anchoring provisions required for ocean/coastal areas and should not be located within 1500' of the coastline in Wind Zones II and III, unless the home and its anchoring and foundation system have been designed for the increased requirements specified for Exposure D in ANSI/ASCE 7-88.

(g) The statement:

This home has—has not—(appropriate blank to be checked by manufacturer) been equipped with storm shutters or other protective coverings for windows and exterior door openings. For homes designed to be located in Wind Zones II and III, which have not been provided with shutters or equivalent covering devices, it is strongly recommended that the home be made ready to be equipped with these devices in accordance with the method recommended in the manufacturers printed instructions.

(h) The statement: "Design Approval by", followed by the name of the agency that approved the design.

[59 FR 2469, Jan. 14, 1994]

§ 3280.6 Serial number.

(a) A manufactured home serial number which will identify the manufacturer and the state in which the manufactured home is manufactured, must be stamped into the foremost cross member. Letters and numbers must be 3/8 inch minimum in height. Numbers must not be stamped into hitch assembly or drawbar.

§ 3280.7

§ 3280.7 Excluded structures.

Certain structures may be excluded from these Standards as modular homes set out in 24 CFR 3282.12.

[52 FR 4581, Feb. 12, 1987]

§ 3280.8 Waivers.

(a) Where any material piece of equipment, or system which does not meet precise requirements or specifications set out in the standard is shown, to the satisfaction of the Secretary, to meet an equivalent level of performance, the Secretary may waive the specifications set out in the Standard for that material, piece of equipment, or system.

(b) Where the Secretary is considering issuing a waiver to a Standard, the proposed waiver shall be published in the FEDERAL REGISTER for public comment, unless the Secretary, for good cause, finds that notice is impractical, unnecessary or contrary to the public interest, and incorporates into the waiver that finding and a brief statement of the reasons therefor.

(c) Each proposed and final waiver shall include:

(1) A statement of the nature of the waiver; and

(2) Identification of the particular standard affected.

(d) All waivers shall be published in the FEDERAL REGISTER and shall state their effective date. Where a waiver has been issued, the requirements of the Federal Standard to which the waiver relates may be met either by meeting the specifications set out in the Standard or by meeting the requirements of the waiver published in the FEDERAL REGISTER.

[58 FR 55003, Oct. 25, 1993]

§ 3280.9 Interpretative bulletins.

Interpretative bulletins may be issued for the following purposes:

(a) To clarify the meaning of the Standard; and

(b) To assist in the enforcement of the Standard.

[58 FR 55003, Oct. 25, 1993]

24 CFR Ch. XX (4-1-11 Edition)

§ 3280.10 Use of alternative construction.

Requests for alternative construction can be made pursuant to 24 CFR 3282.14 of this chapter.

[58 FR 55003, Oct. 25, 1993]

§ 3280.11 Certification label.

(a) A permanent label shall be affixed to each transportable section of each manufactured home for sale or lease in the United States. This label shall be separate and distinct from the data plate which the manufacturer is required to provide under § 3280.5 of the standards.

(b) The label shall be approximately 2 in. by 4 in. in size and shall be permanently attached to the manufactured home by means of 4 blind rivets, drive screws, or other means that render it difficult to remove without defacing it. It shall be etched on 0.32 in. thick aluminum plate. The label number shall be etched or stamped with a 3 letter designation which identifies the production inspection primary inspection agency and which the Secretary shall assign. Each label shall be marked with a 6 digit number which the label supplier shall furnish. The labels shall be stamped with numbers sequentially.

(c) The label shall read as follows:

As evidenced by this label No. ABC 000001, the manufacturer certifies to the best of the manufacturer's knowledge and belief that this manufactured home has been inspected in accordance with the requirements of the Department of Housing and Urban Development and is constructed in conformance with the Federal manufactured home construction and safety standards in effect on the date of manufacture. See date plate.

(d) The label shall be located at the tail-light end of each transportable section of the manufactured home approximately one foot up from the floor and one foot in from the road side, or as near that location on a permanent part of the exterior of the manufactured home unit as practicable. The road side is the right side of the manufactured home when one views the

manufactured home from the tow bar end of the manufactured home.

[42 FR 960, Jan. 4, 1977. Redesignated at 44 FR 20679, Apr. 6, 1979, as amended at 52 FR 47553, Dec. 15, 1987. Redesignated and amended at 58 FR 55003, Oct. 25, 1993]

Subpart B—Planning Considerations

§ 3280.101 Scope.

Subpart B states the planning requirements in manufactured homes. The intent of this subpart is to assure the adequacy of architectural planning considerations which assist in determining a safe and healthful environment.

§ 3280.102 Definitions.

(a) *Gross floor area* means all space, wall to wall, including recessed entries not to exceed 5 sq. ft. and areas under built-in vanities and similar furniture. Where the ceiling height is less than that specified in § 3280.104, the floor area under such ceilings shall not be included. Floor area of closets shall not be included in the gross floor area.

(b) *Habitable room* means a room or enclosed floor space arranged for living, eating, food preparation, or sleeping purposes not including bathrooms, foyers, hallways, and other accessory floor space.

(c) *Laundry area* means an area containing or designed to contain a laundry tray, clothes washer and/or clothes dryer.

§ 3280.103 Light and ventilation.

(a) *Lighting*. Each habitable room shall be provided with exterior windows and/or doors having a total glazed area of not less than 8 percent of the gross floor area.

(1) Kitchens, bathrooms, toilet compartments, laundry areas, and utility rooms may be provided with artificial light in place of windows.

(2) Rooms and areas may be combined for the purpose of providing the required natural lighting provided that at least one half of the common wall area is open and unobstructed, and the open area is at least equal to 10 percent of the combined floor area or 25 square feet whichever is greater.

(b) *Whole-house ventilation*. Each manufactured home must be provided with whole-house ventilation having a minimum capacity of 0.035 ft³/min/ft² of interior floor space or its hourly average equivalent. This ventilation capacity must be in addition to any openable window area. In no case shall the installed ventilation capacity of the system be less than 50 cfm nor more than 90 cfm. The following criteria must be adhered to:

(1) The ventilation capacity must be provided by a mechanical system or a combination passive and mechanical system. The ventilation system or provisions for ventilation must not create a positive pressure in Uo Value Zone 2 and Zone 3 or a negative pressure condition in Uo Value Zone 1. Mechanical systems must be balanced. Combination passive and mechanical systems must have adequately sized inlets or exhaust to release any unbalanced pressure. Temporary pressure imbalances due to gusting or high winds are permitted.

(2) The ventilation system or provisions for ventilation must exchange air directly with the exterior of the home, except the ventilation system, or provisions for ventilation must not draw or expel air with the space underneath the home. The ventilation system or provisions for ventilation must not draw or expel air into the floor, wall, or ceiling/roof systems, even if those systems are vented. The ventilation system must be designed to ensure that outside air is distributed to all bedrooms and main living areas. The combined use of undercut doors or transom grills connecting those areas to the room where the mechanical system is located is deemed to meet this requirement.

(3) The ventilation system or a portion of the system is permitted to be integral with the home's heating or cooling system. The system must be capable of operating independently of the heating or cooling modes. A ventilation system that is integral with the heating or cooling system is to be listed as part of the heating and cooling system or listed as suitable for use with that system.

(4) A mechanical ventilation system, or mechanical portion thereof, must be

§ 3280.104

provided with a manual control, and must be permitted to be provided with automatic timers or humidistats.

(5) A whole-house ventilation label must be attached to the whole-house ventilation control, must be permanent, and must state: "WHOLE-HOUSE VENTILATION".

(6) Instructions for correctly operating and maintaining whole-house ventilation systems must be included with the homeowner's manual. The instructions must encourage occupants to operate these systems whenever the home is occupied, and must refer to the labeled whole-house ventilation control.

(c) *Additional ventilation.* (1) At least half of the minimum required glazed area in paragraph (a) of this section shall be openable directly to the outside of the manufactured home for unobstructed ventilation. These same ventilation requirements apply to rooms combined in accordance with § 3280.103(a)(2).

(2) Kitchens shall be provided with a mechanical ventilation system that is capable of exhausting 100 cfm to the outside of the home. The exhaust fan shall be located as close as possible to the range or cook top, but in no case farther than 10 feet horizontally from the range or cook top.

(3) Each bathroom and separate toilet compartment shall be provided with a mechanical ventilation system capable of exhausting 50 cfm to the outside of the home. A separate toilet compartment may be provided with 1.5 square feet of openable glazed area in place of mechanical ventilation, except in Uo value Zone 3.

[58 FR 55003, Oct. 25, 1993, as amended at 70 FR 72042, Nov. 30, 2005]

§ 3280.104 Ceiling heights.

(a) Every habitable room and bathroom shall have a minimum ceiling height of not less than 7 feet, 0 inches for a minimum of 50 percent of the room's floor area. The remaining area may have a ceiling with a minimum height of 5 feet, 0 inches. Minimum height under dropped ducts, beams, etc. shall be 6 feet, 4 inches.

(b) Hallways and foyers shall have a minimum ceiling height of 6 feet, 6 inches.

24 CFR Ch. XX (4-1-11 Edition)

§ 3280.105 Exit facilities; exterior doors.

(a) *Number and location of exterior doors.* Manufactured homes shall have a minimum of two exterior doors located remote from each other.

(1) Required egress doors shall not be located in rooms where a lockable interior door must be used in order to exit.

(2) In order for exit doors to be considered *remote* from each other, they must comply with all of the following:

(i) Both of the required doors must not be in the same room or in a group of rooms which are not defined by fixed walls.

(ii) *Single wide units.* Doors may not be less than 12 ft. c-c from each other as measured in any straight line direction regardless of the length of path of travel between doors.

(iii) *Double wide units.* Doors may not be less than 20 ft. c-c from each other as measured in any straight line direction regardless of the length of path of travel between doors.

(iv) One of the required exit doors must be accessible from the doorway of each bedroom without traveling more than 35 ft.

(b) *Door design and construction.* (1) Exterior swinging doors shall be constructed in accordance with § 3280.405 the "Standard for Swinging Exterior Passage Doors for Use in Manufactured Homes". Exterior sliding glass doors shall be constructed in accordance with § 3280.403 the "Standard for Windows and Sliding Glass Doors Used in Manufactured Homes".

(2) All exterior swinging doors shall provide a minimum 28 inch wide by 74 inch high clear opening. All exterior sliding glass doors shall provide a minimum 28 inch wide by 72 inch high clear opening.

(3) Each swinging exterior door other than screen or storm doors shall have a key-operated lock that has a deadlocking latch or a key-operated dead bolt with a passage latch. Locks shall not require the use of a key for operation from the inside.

(4) All exterior doors, including storm and screen doors, opening outward shall be provided with a safety door check.

[40 FR 58752, Dec. 18, 1975. Redesignated at 44 FR 20679, Apr. 6, 1979, as amended at 50 FR 9269, Mar. 7, 1985]

§ 3280.106 Exit facilities; egress windows and devices.

(a) Every room designed expressly for sleeping purposes, unless it has an exit door (*see* § 3280.105), shall have at least one outside window or approved exit device which meets the requirements of § 3280.404, the "Standard for Egress Windows and Devices for Use in Manufactured Homes."

(b) The bottom of the window opening shall not be more than 36 inches above the floor.

(c) Locks, latches, operating handles, tabs, and any other window screen or storm window devices which need to be operated in order to permit exiting, shall not be located in excess of 54 inches from the finished floor.

(d) Integral rolled-in screens shall not be permitted in an egress window unless the window is of the hinged-type.

[49 FR 58752, Dec. 18, 1975. Redesignated at 44 FR 20679, Apr. 6, 1979, as amended at 49 FR 36086, Sept. 14, 1984; 52 FR 4581, Feb. 12, 1987]

§ 3280.107 Interior privacy.

Bathroom and toilet compartment doors shall be equipped with a privacy lock.

§ 3280.108 Interior passage.

(a) Interior doors having passage hardware without a privacy lock, or with a privacy lock not engaged, shall open from either side by a single movement of the hardware mechanism in any direction.

(b) Each manufactured home interior door, when provided with a privacy lock, shall have a privacy lock that has an emergency release on the outside to permit entry when the lock has been locked by a locking knob, lever, button, or other locking device on the inside.

§ 3280.109 Room requirements.

(a) Every manufactured home shall have at least one living area with not less than 150 sq. ft. of gross floor area.

(b) Rooms designed for sleeping purposes shall have a minimum gross square foot floor area as follows:

(1) All bedrooms shall have at least 50 sq. ft. of floor area.

(2) Bedrooms designed for two or more people shall have 70 sq. ft. of floor area plus 50 sq. ft. for each person in excess of two.

(c) Every room designed for sleeping purposes shall have accessible clothes hanging space with a minimum inside depth of 22 inches and shall be equipped with a rod and shelf.

[40 FR 58752, Dec. 18, 1975. Redesignated at 44 FR 20679, Apr. 6, 1979, and further redesignated at 58 FR 55004, Oct. 25, 1993]

§ 3280.110 Minimum room dimensions.

The gross floor area required by § 3280.110 (a) and (b) shall have no clear horizontal dimension less than 5 feet except as permitted by § 3280.102(a).

[40 FR 58752, Dec. 18, 1975. Redesignated at 44 FR 20679, Apr. 6, 1979, and further redesignated at 58 FR 55004, Oct. 25, 1993]

§ 3280.111 Toilet compartments.

Each toilet compartment shall be a minimum of 30 inches in width, except, when the toilet is located adjacent to the short dimension of the tub, the distance from the tub to the center line of the toilet shall not be less than 12 inches. At least 21 inches of clear space shall be provided in front of each toilet.

[40 FR 58752, Dec. 18, 1975. Redesignated at 44 FR 20679, Apr. 6, 1979, and further redesignated at 58 FR 55004, Oct. 25, 1993]

§ 3280.112 Hallways.

Hallways shall have a minimum horizontal dimension of 28 inches measured from the interior finished surface to the interior finished surface of the opposite wall. When appliances are installed in a laundry area, the measurement shall be from the front of the appliance to the opposite finished interior surface. When appliances are not installed and a laundry area is provided, the area shall have a minimum clear depth of 27 inches in addition to

§ 3280.113

the 28 inches required for passage. In addition, a notice of the available clearance for washer/dryer units shall be posted in the laundry area. Minor protrusions into the minimum hallway width by doorknobs, trim, smoke alarms or light fixtures are permitted.

[40 FR 58752, Dec. 18, 1975. Redesignated at 44 FR 20679, Apr. 6, 1979, and further redesignated at 58 FR 55004, Oct. 25, 1993; 67 FR 12817, Mar. 19, 2002]

§ 3280.113 Glass and glazed openings.

(a) *Windows and sliding glass doors.* All windows and sliding glass doors shall meet the requirements of § 3280.403 the "Standard for Windows and Sliding Glass Doors Used in Manufactured Homes".

(b) *Safety glazing.* Glazing in all entrance or exit doors, sliding glass doors, units (fixed or moving sections), unframed glass doors, unbacked mirrored wardrobe doors (*i.e.*, mirrors not secured to a backing capable of being the door itself), shower and bathtub enclosures and surrounds to a height of 6 feet above the bathroom floor level, storm doors or combination doors, and in panels located within 12 inches on either side of exit or entrance doors shall be of a safety glazing material. Safety glazing material is considered to be any glazing material capable of passing the requirements of Safety Performance Specifications and Methods of Test for Safety Glazing Materials Used in Buildings, ANSI Z97.1-1984.

[40 FR 58752, Dec. 18, 1975. Redesignated at 44 FR 20679, Apr. 6, 1979, as amended at 52 FR 4581, Feb. 12, 1987. Redesignated at 58 FR 55004, Oct. 25, 1993]

Subpart C—Fire Safety

SOURCE: 49 FR 32008, Aug. 9, 1984, unless otherwise noted.

§ 3280.201 Scope.

The purpose of this subpart is to set forth requirements that will assure reasonable fire safety to the occupants by reducing fire hazards and by providing measures for early detection.

24 CFR Ch. XX (4-1-11 Edition)

§ 3280.202 Definitions.

The following definitions are applicable to subparts C, H, and I of the Standards:

Combustible material: Any material not meeting the definition of limited-combustible or non-combustible material.

Flame-spread rating: The measurement of the propagation of flame on the surface of materials or their assemblies as determined by recognized standard tests conducted as required by this subpart.

Interior finish: The surface material of walls, fixed or movable partitions, ceilings, columns, and other exposed interior surfaces affixed to the home's structure including any materials such as paint or wallpaper and the substrate to which they are applied. Interior finish does not include:

(1) Trim and sealant 2 inches or less in width adjacent to the cooking range and in furnace and water heater spaces provided it is installed in accordance with the requirements of § 3280.203(b)(3) or (4), and trim 6 inches or less in width in all other areas;

(2) Windows and frames;

(3) Single doors and frames and a series of doors and frames not exceeding 5 feet in width;

(4) Skylights and frames;

(5) Casings around doors, windows, and skylights not exceeding 4 inches in width;

(6) Furnishings which are not permanently affixed to the home's structure;

(7) Baseboards not exceeding 6 inches in height;

(8) Light fixtures, cover plates of electrical receptacle outlets, switches, and other devices;

(9) Decorative items attached to walls and partitions (*i.e.*, pictures, decorative objects, etc.) constituting no more than 10% of the aggregate wall surface area in any room or space not more than 32 square feet in surface area, whichever is less;

(10) Plastic light diffusers when suspended from a material which meets the interior finish provisions of § 3280.203(b);

(11) Coverings and surfaces of exposed wood beams; and

(12) Decorative items including the following:

(i) Non-structural beams not exceeding 6 inches in depth and 6 inches in width and spaced not closer than 4 feet on center;

(ii) Non-structural lattice work;

(iii) Mating and closure molding; and

(iv) Other items not affixed to the home's structure.

Limited combustible: A material meeting:

(1) The definition contained in Chapter 2 of NFPA 220-1995, Standard on Types of Building Construction; or

(2) 5/16-inch or thicker gypsum board.

Noncombustible material: A material meeting the definition contained in Chapter 2 of NFPA 220-1995, Standard on Types of Building Construction.

Smoke alarm: An alarm device that is responsive to smoke.

Tactile notification appliance: A notification appliance that alerts by the sense of touch or vibration.

[58 FR 55004, Oct. 25, 1993, as amended at 67 FR 12817, Mar. 19, 2002; 70 FR 72042, Nov. 30, 2005]

§ 3280.203 Flame spread limitations and fire protection requirements.

(a) *Establishment of flame spread rating.* The surface flame spread rating of interior-finish material must not exceed the value shown in § 3280.203(b) when tested by Standard Test Method for Surface Burning Characteristics of Building Materials, ASTM E84-01, 2001, or Standard Method of Test of Surface Burning Characteristics of Building Materials NFPA 255, 1996, except that the surface flame spread rating of interior-finish materials required by § 3280.203(b)(5) and (6) may be determined by using the Standard Test Method for Surface Flammability of Materials Using a Radiant Heat Energy Source, ASTM E 162-94. However, the following materials need not be tested to establish their flame spread rating unless a lower rating is required by the standards in this part:

(1) Flame-spread rating—76 to 200.

(i) .035-inch or thicker high pressure laminated plastic panel countertop;

(ii) 1/4-inch or thicker unfinished plywood with phenolic or urea glue;

(iii) Unfinished dimension lumber (1-inch or thicker nominal boards);

(iv) 3/8-inch or thicker unfinished particleboard with phenolic or urea binder;

(v) Natural gum-varnished or latex- or alkyd-painted:

(A) 1/4-inch or thicker plywood, or

(B) 3/8-inch or thicker particleboard, or

(C) 1-inch or thicker nominal board;

(vi) 5/16-inch gypsum board with decorative wallpaper; and

(vii) 1/4-inch or thicker unfinished hardboard,

(2) Flame-spread rating-25 to 200,

(i) Painted metal;

(ii) Mineral-base acoustic tile;

(iii) 5/16-inch or thicker unfinished gypsum wallboard (both latex- or alkyd-painted); and

(iv) Ceramic tile.

(The above-listed material applications do not waive the requirements of § 3280.203(c) or § 3280.204 of this subpart.)

(b) Flame-spread rating requirements.

(1) The interior finish of all walls, columns, and partitions shall not have a flame spread rating exceeding 200 except as otherwise specified herein.

(2) Ceiling interior finish shall not have a flame spread rating exceeding 75.

(3) Walls adjacent to or enclosing a furnace or water heater and ceilings above them shall have an interior finish with a flame spread rating not exceeding 25. Sealants and other trim materials 2 inches or less in width used to finish adjacent surfaces within these spaces are exempt from this provision provided that all joints are completely supported by framing members or by materials having a flame spread rating not exceeding 25.

(4) Exposed interior finishes adjacent to the cooking range shall have a flame spread rating not exceeding 50, except that backsplashes not exceeding 6 inches in height are exempted. Adjacent surfaces are the exposed vertical surfaces between the range top height and the overhead cabinets and/or ceiling and within 6 horizontal inches of the cooking range. (Refer also to § 3280.204(a), Kitchen Cabinet Protection.) Sealants and other trim materials 2 inches or less in width used to finish adjacent surfaces are exempt from this provision provided that all

§ 3280.204

24 CFR Ch. XX (4-1-11 Edition)

joints are completely supported by a framing member.

(5) Kitchen cabinet doors, countertops, backsplashes, exposed bottoms, and end panels shall have a flame spread rating not to exceed 200. Cabinet rails, stiles, mullions, and top strips are exempted.

(6) Finish surfaces of plastic bathtubs, shower units, and tub or shower doors shall not exceed a flame spread rating of 200.

(c) Fire protective requirements.

(1) Materials used to surface the following areas shall be of limited combustible material (e.g., $\frac{5}{16}$ -inch gypsum board, etc.):

(i) The exposed wall adjacent to the cooking range (see § 3280.203(b)(4));

(ii) Exposed bottoms and sides of kitchen cabinets as required by § 3280.204;

(iii) Interior walls and ceilings enclosing furnace and/or water heater spaces; and

(iv) Combustible doors which provide interior or exterior access to furnace and/or water heater spaces. The surface may be interrupted for louvers ventilating the enclosure. However, the louvers shall not be constructed of a material of greater combustibility than the door itself (e.g., plastic louvers on a wooden door).

(2) No burner of a surface cooking unit shall be closer than 12 horizontal inches to a window or an exterior door with glazing.

[49 FR 32008, Aug. 9, 1984, as amended at 58 FR 55005, Oct. 25, 1993; 70 FR 72042, Nov. 30, 2005]

§ 3280.204 Kitchen cabinet protection.

(a) The bottom and sides of combustible kitchen cabinets over cooking ranges to a horizontal distance of 6 inches from the outside edge of the cooking range shall be protected with at least $\frac{5}{16}$ -inch thick gypsum board or equivalent limited combustible material. One-inch nominal framing members and trim are exempted from this requirement. The cabinet area over the cooking range or cooktops shall be protected by a metal hood (26-gauge sheet metal, or .017 stainless steel, or .024 aluminum, or .020 copper) with not less than a 3-inch eyebrow projecting horizontally from the front cabinet face.

The $\frac{5}{16}$ -inch thick gypsum board or equivalent material which is above the top of the hood may be supported by the hood. A $\frac{3}{8}$ -inch enclosed air space shall be provided between the bottom surface of the cabinet and the gypsum board or equivalent material. The hood shall be at least as wide as the cooking range.

(b) The 3-inch metal eyebrow required by paragraph (a) of this section will project from the front and rear cabinet faces when there is no adjacent surface behind the range, or the $\frac{5}{16}$ -inch thick gypsum board or equivalent material shall be extended to cover all exposed rear surfaces of the cabinet.

(c) The metal hood required by paragraphs (a) and (b) of this section can be omitted when an oven of equivalent metal protection is installed between the cabinet and the range and all exposed cabinet surfaces are protected as described in paragraph (a) of this section.

(d) When a manufactured home is designed for the future installation of a cooking range, the metal hood and cabinet protection required by paragraph (a) of this section and the wall-surfacing protection behind the range required by § 3280.203 shall be installed in the factory.

(e) Vertical clearance above cooking top. Ranges shall have a vertical clearance above the cooking top of not less than 24 inches to the bottom of combustible cabinets.

§ 3280.205 Carpeting.

Carpeting shall not be used in a space or compartment designed to contain only a furnace and/or water heater. Carpeting may be used in other areas where a furnace or water heater is installed, provided that it is not located under the furnace or water heater.

§ 3280.206 Fireblocking.

(a) *General.* Fireblocking must comply with the requirements of this section. The integrity of all fireblocking materials must be maintained.

(b) *Fireblocking materials.* Fireblocking must consist of the following materials:

(1) Minimum one inch nominal lumber, $\frac{5}{16}$ inch thick gypsum board, or equivalent fire resistive materials; or

(2) Other Listed or Approved Materials;

(c) *Fireblocking locations.* (1) Fireblocking must be installed in concealed spaces of stud walls, partitions, and furred spaces at the floor and ceiling levels. Concealed spaces must not communicate between floor levels. Concealed spaces must not communicate between a ceiling level and a concealed roof area, or an attic space.

(2) Fireblocking must be installed at the interconnection of a concealed vertical space and a concealed horizontal space that occurs:

(i) Between a concealed wall cavity and the ceiling joists above; and

(ii) At soffits, drop ceilings, cover ceilings, and similar locations.

(3) Fireblocking must be installed around the openings for pipes, vents, and other penetrations in walls, floors, and ceilings of furnace and water heater spaces. Pipes, vents, and other penetrations that cannot be moved freely within their opening are considered to be fireblocked. Materials used to fireblock heat producing vent penetrations must be noncombustible or limited combustible types.

[71 FR 72042, Nov. 30, 2005]

§ 3280.207 Requirements for foam plastic thermal insulating materials.

(a) *General.* Foam plastic thermal insulating materials shall not be used within the cavity of walls (not including doors) or ceilings or be exposed to the interior of the home unless:

(1) The foam plastic insulating material is protected by an interior finish of $\frac{5}{16}$ -inch thick gypsum board or equivalent material for all cavities where the material is to be installed; or

(2) The foam plastic is used as a sheathing or siding backerboard, and it:

(i) Has a flame spread rating of 75 or less and a smoke-developed rating of 450 or less (not including outer covering of sheathing);

(ii) Does not exceed $\frac{3}{8}$ -inch in thickness; and

(iii) Is separated from the interior of the manufactured home by a minimum of 2 inches of mineral fiber insulation or an equivalent thermal barrier; or

(3) The foam plastic insulating material has been previously accepted by

the Department for use in wall and/or ceiling cavities of manufactured homes, and it is installed in accordance with any restrictions imposed at the time of that acceptance; or

(4) The foam plastic insulating material has been tested as required for its location in wall and/or ceiling cavities in accordance with testing procedures described in the Illinois Institute of Technology Research Institute (IIT) Report, "Development of Mobile Home Fire Test Methods to Judge the Fire-Safe Performance of Foam Plastic Sheathing and Cavity Insulation, IITRI Fire and Safety Research Project J-6461, 1979" or other full-scale fire tests accepted by HUD, and it is installed in a manner consistent with the way the material was installed in the foam plastic test module. The materials must be capable of meeting the following acceptance criteria required for their location:

(i) *Wall assemblies.* The foam plastic system shall demonstrate equivalent or superior performance to the control module as determined by:

(A) Time to reach flashover (600 °C in the upper part of the room);

(B) Time to reach an oxygen (O₂) level of 14% (rate of O₂ depletion), a carbon monoxide (CO) level of 1%, a carbon dioxide (CO₂) level of 6%, and a smoke level of 0.26 optical density/meter measured at 5 feet high in the doorway; and

(C) Rate of change concentration for O₂, CO, CO₂ and smoke measured 3 inches below the top of the doorway.

(ii) *Ceiling assemblies.* A minimum of three valid tests of the foam plastic system and one valid test of the control module shall be evaluated to determine if the foam plastic system demonstrates equivalent or superior performance to the control module. Individual factors to be evaluated include intensity of cavity fire (temperature-time) and post-test damage.

(iii) *Post-test damage assessment for wall and ceiling assemblies.* The overall performance of each total system shall also be evaluated in determining the acceptability of a particular foam plastic insulating material.

(b) All foam plastic thermal insulating materials used in manufactured

§ 3280.208

24 CFR Ch. XX (4-1-11 Edition)

housing shall have a flame spread rating of 75 or less (not including outer covering or sheathing) and a maximum smoke-developed rating of 450.

[49 FR 32008, Aug. 9, 1984, as amended at 70 FR 72043, Nov. 30, 2005]

§ 3280.208 Smoke alarm requirements.

(a) *Labeling.* Each smoke alarm required under paragraph (b) of this section must conform with the requirements of UL 217, Single and Multiple Station Smoke Alarms, dated January 4, 1999 (incorporated by reference, see § 3280.4), or UL 268, Smoke Detectors for Fire Protective Signaling Systems, dated January 4, 1999 (incorporated by reference, see § 3280.4), and must bear a label to evidence conformance.

(b) *Required smoke alarm locations.* (1) At least one smoke alarm must be installed in each of the following locations:

(i) To protect both the living area and kitchen space. Manufacturers are encouraged to locate the alarm in the living area remote from the kitchen and cooking appliances. A smoke alarm located within 20 feet horizontally of a cooking appliance must incorporate a temporary silencing feature or be of a photoelectric type.

(ii) In each room designed for sleeping.

(iii) On the ceiling of the upper level near the top or above each stairway, other than a basement stairway, in any multistory home completed in accordance with this part or part 3282 of this chapter. The alarm must be located so that smoke rising in the stairway cannot be prevented from reaching the alarm by an intervening door or obstruction.

(2) For each home designed to be placed over a basement, the manufacturer must provide a smoke alarm for the basement and must install at the factory an electrical junction box for the installation of this smoke alarm and for its interconnection to other smoke alarms required by this section. The instructions for installers and information for homeowners required in paragraph (f) of this section must clearly indicate that a smoke alarm should be installed and is to be located on the basement ceiling near the stairway.

(3) A smoke alarm required under this section must not be placed in a location that impairs its effectiveness or in any of the following locations:

(i) Within 3 feet horizontally from any discharge grille when a home is equipped or designed for future installation of a roof-mounted evaporative cooler or other equipment discharging conditioned air through a ceiling grille into the living space; and

(ii) In any location or environment that is prohibited by the terms of its listing, except as permitted by this section.

(c) *Mounting requirements.* (1) Except in rooms with peaked sloping or shed sloping ceilings with a slope of more than 1.5/12 or as permitted pursuant to paragraph (e) of this section, smoke alarms must be mounted either:

(i) On the ceiling at least 4 inches from each wall; or

(ii) On a wall with the top of the alarm not less than 4 inches below the ceiling, and not farther from the ceiling than 12 inches or the distance from the ceiling specified in the smoke alarm manufacturer's listing and instructions, whichever is less.

(2) Except as permitted pursuant to paragraph (e) of this section, in rooms with peaked sloping ceilings with a slope of more than 1.5/12, smoke alarms must be mounted on the ceiling within 3 feet, measured horizontally, from the peak of the ceiling; at least 4 inches, measured vertically, below the peak of the ceiling; and at least 4 inches from any projecting structural element.

(3) Except as permitted pursuant to paragraph (e) of this section, in rooms with shed sloping ceilings with a slope of more than 1.5/12, smoke alarms must be mounted on the ceiling within 3 feet, measured horizontally, of the high side of the ceiling, and not closer than 4 inches from any adjoining wall surface and from any projecting structural element.

(d) *Connection to power source.* (1) Each smoke alarm must be powered from:

(i) The electrical system of the home as the primary power source and a battery as a secondary power source; or

(ii) A battery rated for a 10-year life, provided the smoke alarm is listed for use with a 10-year battery.

(2) Each smoke alarm whose primary power source is the home electrical system must be mounted on an electrical outlet box and connected by a permanent wiring method to a general electrical circuit. More than one smoke alarm is permitted to be placed on the same electrical circuit. The wiring circuit for the alarm must not include any switches between the over-current protective device and the alarm, and must not be protected by a ground fault circuit interrupter.

(3) Smoke alarms required under this section must be interconnected such that the activation of any one smoke alarm causes the alarm to be triggered in all required smoke alarms in the home.

(e) *Visible and tactile notification appliances.* (1) In addition to the smoke alarms required pursuant to this section, the manufacturer must provide visible and listed tactile notification appliances if these appliances are ordered by the purchaser or retailer before the home enters the first stage of production. These appliances are required to operate from the primary power source, but are not required to operate from a secondary power source.

(2) A visible notification appliance in a room designed for sleeping must have a minimum rating of 177 candela, except that when the visible notification appliance is wall-mounted or suspended more than 24 inches below the ceiling, a minimum rating of 110 candela is permitted.

(3) A visible notification appliance in an area other than a room designed for sleeping must have a minimum rating of 15 candela.

(f) *Testing and maintenance.* (1) Each required smoke alarm installed at the factory must be operationally tested, after conducting the dielectric test specified in § 3280.810(a), in accordance with the alarm manufacturer's instructions. A smoke alarm that does not function as designed during the test and is not fixed so that it functions properly in the next retest must be replaced. Any replacement smoke alarm must be successfully tested in accordance with this paragraph.

(2) Home manufacturers must provide specific written instructions for installers on how to inspect and test the

operation of smoke alarms during installation of the home. These instructions must indicate that any smoke alarm that does not meet the inspection or testing requirements needs to be replaced and retested.

(3) Home manufacturers must provide the homeowner with the alarm manufacturer's information describing the operation, method and frequency of testing, and proper maintenance of the smoke alarm. This information must be provided in same manner and location as the consumer manual required by § 3282.207 of this chapter, but does not have to be incorporated into the consumer manual. No dealer, distributor, construction contractor, or other person shall interfere with the distribution of this information

[67 FR 12817, Mar. 19, 2002, as amended at 67 FR 49795, July 31, 2002]

§ 3280.209 Fire testing.

All fire testing conducted in accordance with this subpart shall be performed by nationally recognized testing laboratories which have expertise in fire technology. In case of dispute, the Secretary shall determine if a particular agency is qualified to perform such fire tests.

[49 FR 32011, Aug. 9, 1984]

Subpart D—Body and Frame Construction Requirements

§ 3280.301 Scope.

This subpart covers the minimum requirements for materials, products, equipment and workmanship needed to assure that the manufactured home will provide:

- (a) Structural strength and rigidity,
- (b) Protection against corrosion, decay, insects and other similar destructive forces,
- (c) Protection against hazards of windstorm,
- (d) Resistance to the elements, and
- (e) Durability and economy of maintenance.

§ 3280.302 Definitions.

The following definitions are applicable to subpart D only:

§ 3280.303

24 CFR Ch. XX (4–1–11 Edition)

Anchor assembly means any device or other means designed to transfer home anchoring loads to the ground.

Anchoring equipment means ties, straps, cables, turnbuckles, chains, and other approved components, including tensioning devices that are used to secure a manufactured home to anchor assemblies.

Anchoring system means a combination of anchoring equipment and anchor assemblies that will, when properly designed and installed, resist the uplift, overturning, and lateral forces on the manufactured home and on its support and foundation system.

Diagonal tie means a tie intended to resist horizontal or shear forces, but which may resist vertical, uplift, and overturning forces.

Footing: means that portion of the support system that transmits loads directly to the soil.

Foundation system means a system of support that is capable of transferring all design loads to the ground, including elements of the support system as defined in this section, or a site-built permanent foundation that meets the requirements of 24 CFR 3282.12.

Ground anchor means a specific anchoring assembly device designed to transfer home anchoring loads to the ground.

Loads: (1) *Dead load*: means the weight of all permanent construction including walls, floors, roof, partition, and fixed service equipment.

(2) *Live load*: means the weight superimposed by the use and occupancy of the manufactured home, including wind load and snow load, but not including dead load.

(3) *Wind load*: means the lateral or vertical pressure or uplift on the manufactured home due to wind blowing in any direction.

Main frame: means the structural component on which is mounted the body of the manufactured home.

Pier: means that portion of the support system between the footing and manufactured home exclusive of caps and shims.

Sheathing: means material which is applied on the exterior side of a building frame under the exterior weather resistant covering.

Stabilizing devices means all components of the anchoring and support systems, such as piers, footings, ties, anchoring equipment, anchoring assemblies, or any other equipment, materials, and methods of construction that support and secure the manufactured home to the ground.

Support system: means a combination of footings, piers, caps, and shims that will, when properly installed, support the manufactured home.

Support system means any pilings, columns, footings, piers, foundation walls, shims, and any combination thereof that, when properly installed, support the manufactured home.

Tie: means straps, cable, or securing devices used to connect the manufactured home to ground anchors.

Vertical tie: means a tie intended to resist the uplifting or overturning forces.

[58 FR 55005, Oct. 25, 1993; 59 FR 15113, Mar. 31, 1994, as amended at 72 FR 59361, Oct. 19, 2007]

§ 3280.303 General requirements.

(a) *Minimum requirements*. The design and construction of a manufactured home shall conform with the provisions of this standard. Requirements for any size, weight, or quality of material modified by the terms of *minimum*, *not less than*, *at least*, and similar expressions are minimum standards. The manufacturer or installer may exceed these standards provided such deviation does not result in any inferior installation or defeat the purpose and intent of this standard.

(b) *Construction*. All construction methods shall be in conformance with accepted engineering practices to insure durable, livable, and safe housing and shall demonstrate acceptable workmanship reflecting journeyman quality of work of the various trades.

(c) *Structural analysis*. The strength and rigidity of the component parts and/or the integrated structure shall be determined by engineering analysis or by suitable load tests to simulate the actual loads and conditions of application that occur. (See subparts E and J.)

(d) [Reserved]

(e) *New materials and methods*. (1) Any new material or method of construction not provided for in this standard

and any material or method of questioned suitability proposed for use in the manufacture of the structure shall nevertheless conform in performance to the requirements of this standard.

(2) Unless based on accepted engineering design for the use indicated, all new manufactured home materials, equipment, systems or methods of construction not provided for in this standard shall be subjected to the tests specified in paragraph (g) of this section.

(f) *Allowable design stress.* The design stresses of all materials shall conform to accepted engineering practice. The use of materials not certified as to strength or stress grade shall be limited to the minimum allowable stresses under accepted engineering practice.

(g) *Alternative test procedures.* In the absence of recognized testing procedures either in the Standards in this part or in the applicable provisions of those standards incorporated in this part by reference, the manufacturer electing this option must develop or cause to be developed testing procedures to demonstrate the structural properties and significant characteristics of the material, assembly, sub-assembly component, or member, except for testing methods involving one-piece metal roofing as would be required in § 3280.305(c)(1)(iii). Such testing procedures become part of the manufacturer's approved design. Such tests must be witnessed by an independent licensed professional engineer or architect or by a recognized testing organization. Copies of the test results must be kept on file by the manufactured home manufacturer.

[40 FR 58752, Dec. 18, 1975. Redesignated at 44 FR 20679, Apr. 6, 1979, as amended at 58 FR 55005, Oct. 25, 1993; 59 FR 2469, Jan. 14, 1994; 70 FR 72043, Nov. 30, 2005]

§ 3280.304 Materials.

(a) Dimension and board lumber shall not exceed 19 percent moisture content at time of installation.

(b)(1) Standards for some of the generally used materials and methods of construction are listed in the following table:

Aluminum

Aluminum Design Manual, Specifications and Guidelines for Aluminum Structures, Part 1-A, Sixth Edition, October 1994, and Part 1-B, First Edition, October 1994.

Steel

Specification for Structural Steel Buildings—Allowable Stress Design and Plastic Design—AISC-S335, 1989. The following parts of this reference standard are not applicable: 1.3.3, 1.3.4, 1.3.5, 1.3.6, 1.4.6, 1.5.1.5, 1.5.5, 1.6, 1.7, 1.8, 1.9, 1.10.4 through 1.10.7, 1.10.9, 1.11, 1.13, 1.14.5, 1.17.7 through 1.17.9, 1.19.1, 1.19.3, 1.20, 1.21, 1.23.7, 1.24, 1.25.1 through 1.25.5, 1.26.4, 2.3, 2.4, 2.8 through 2.10.

Specification for the Design of Cold-Formed Steel Structural Members—AISI-1996.

Specification for the Design of Cold-Formed Stainless Steel Structural Members—SEI/ASCE 8-02, 2002.

Standard Specifications Load Tables and Weight Tables for Steel Joists and Joist Girders, SJI, Fortieth Edition, 1994.

Structural Applications of Steel Cables for Buildings—ASCE19, 1996.

Standard Specification for Strapping, Flat Steel and Seals—ASTM D3953, 1991.

Wood and Wood Products

Basic Hardboard—ANSI/AHA A135.4-1995.

Prefinished Hardboard Paneling—ANSI/AHA A135.5-1995.

Hardboard Siding—ANSI/AHA A135.6-1998.

American National Standard for Hardwood and Decorative Plywood—ANSI/HPVA HP-1-1994 (Approved 1995).

Structural Design Guide for Hardwood Plywood Wall Panels—HPVA Design Guide HP-SG-96, 1996.

For wood products—Structural Glued Laminated Timber—ANSI/AITC A190.1-1992.

Construction and Industrial Plywood (With Typical APA Trademarks)—PS 1-95.

APA Design/Construction Guide, Residential and Commercial—APA E30-P-1996.

Design Specifications for Metal Plate and Wood Connected Trusses—TPI-85.

Design and Fabrication of All-Plywood Beams—APA H-815E (PDS Supplement #5), 1995.

Panel Design Specification—APA D410A, 2004.

Design and Fabrication of Glued Plywood-Lumber Beams—APA-S 812Q, Suppl. 2-1992.

Design and Fabrication of Plywood Curved Panels—APA-S 811M, Suppl. 1, 1990.

Design and Fabrication of Plywood Sandwich Panels—APA-U 814H, Suppl. 4, 1990.

Voluntary Product Standard, Performance Standard for Wood-based Structural Use Panels—PS 2-92, 1992 (also known as NIST Standard PS 2-96).

§ 3280.305

Design and Fabrication of Plywood Stressed-Skin Panels—APA-U 813L, Suppl. 3, 1990.

National Design Specifications for Wood Construction, 2001 Edition, with Supplement, Design Values for Wood Construction, NDS-2001, ANSI/AFPA.

Wood Structural Design Data, 1989, Revised 1992, AFPA.

Span Tables for Joists and Rafters—PS-20-70, 1993, AFPA.

Design Values for Joists and Rafters 1992, AFPA.

Particleboard—ANSI A208.1-1999.

Voluntary Specifications for Aluminum, Vinyl (PVC) and Wood Windows and Glass Doors—ANSI/AAMA/NWDA 101/I.S.2-97.

Standard Test Methods for Puncture and Stiffness of Paperboard, and Corrugated and Solid Fiberboard—ASTM D781, 1973.

Standard Test Methods for Direct Moisture Content Measurement of Wood and Wood-Base Materials—ASTM D 4442-92 (Re-approved 1997), 1997.

Standard Test Methods for Use and Calibration of Hand-Held Moisture Meters—ASTM D4444, 1992.

Other

Standard Specification for Gypsum Wallboard—ASTM C 36/C 36M-99, 1999.

Fasteners

National Evaluation Report, Power Driven Staples, Nails, and Allied Fasteners for Use in All Types of Building Construction—NER-272, 1997.

Unclassified

Minimum Design Loads for Buildings and Other Structures—ASCE 7-1988.

Safety Performance Specifications and Methods of Test for Safety Glazing Materials Used in Building—ANSI Z97.1-1984.

(2) Materials and methods of construction utilized in the design and construction of manufactured homes which are covered by the standards in the following table, or any applicable portion thereof shall comply with these requirements.

(3) Engineering analysis and testing methods contained in these references shall be utilized to judge conformance with accepted engineering practices required in § 3280.303(c).

(4) Materials and methods of installation conforming to these standards shall be considered acceptable when installed in conformance with the requirements of this part.

(5) Materials meeting the standards (or the applicable portion thereof) are

24 CFR Ch. XX (4-1-11 Edition)

considered acceptable unless otherwise specified herein or unless substantial doubt exists as to conformance.

(c) Wood products shall be identified as complying with the appropriate standards.

[40 FR 58752, Dec. 18, 1975, as amended at 42 FR 961, Jan. 4, 1977. Redesignated at 44 FR 20679, Apr. 6, 1979, as amended at 58 FR 55006, Oct. 25, 1993; 59 FR 15113, Mar. 31, 1994; 70 FR 72043, Nov. 30, 2005]

§ 3280.305 Structural design requirements.

(a) *General.* Each manufactured home shall be designed and constructed as a completely integrated structure capable of sustaining the design load requirements of this standard, and shall be capable of transmitting these loads to stabilizing devices without exceeding the allowable stresses or deflections. Roof framing shall be securely fastened to wall framing, walls to floor structure, and floor structure to chassis to secure and maintain continuity between the floor and chassis, so as to resist wind overturning, uplift, and sliding as imposed by design loads in this part. Uncompressed finished flooring greater than 1/8 inch in thickness shall not extend beneath load-bearing walls that are fastened to the floor structure.

(b) *Design loads*—(1) *Design dead loads.* Design dead loads shall be the actual dead load supported by the structural assembly under consideration.

(2) *Design live loads.* The design live loads and wind and snow loads shall be as specified in this section and shall be considered to be uniformly distributed. The roof live load or snow load shall not be considered as acting simultaneously with the wind load and the roof live or snow load and floor live loads shall not be considered as resisting the overturning moment due to wind.

(3) When engineering calculations are performed, allowable unit stresses may be increased as provided in the documents referenced in § 3280.304 except as otherwise indicated in §§ 3280.304(b)(1) and 3280.306(a).

(4) Whenever the roof slope does not exceed 20 degrees, the design horizontal wind loads required by § 3280.305(c)(1) may be determined without including

the vertical roof projection of the manufactured home. However, regardless of the roof slope of the manufactured home, the vertical roof projection shall be included when determining the wind loading for split level or clerestory-type roof systems.

(c) *Wind, snow, and roof loads*—(1) *Wind loads—design requirements.* (i) *Standard wind loads (Zone I).* When a manufactured home is not designed to resist the wind loads for high wind areas (Zone II or Zone III) specified in paragraph (c)(1)(ii) of this section, the manufactured home and each of its wind resisting parts and portions shall be designed for horizontal wind loads of not less than 15 psf and net uplift load of not less than 9 psf.

(ii) *Wind loads for high wind areas (Zone II and Zone III).* When designed for high wind areas (Zone II and Zone III), the manufactured home, each of

its wind resisting parts (including, but not limited to, shear walls, diaphragms, ridge beams, and their fastening and anchoring systems), and its components and cladding materials (including, but not limited to, roof trusses, wall studs, exterior sheathing, roofing and siding materials, exterior glazing, and their connections and fasteners) shall be designed by a Professional Engineer or Architect to resist:

(A) The design wind loads for Exposure C specified in ANSI/ASCE 7-88, “Minimum Design Loads for Buildings and Other Structures,” for a fifty-year recurrence interval, and a design wind speed of 100 mph, as specified for Wind Zone II, or 110 mph, as specified for Wind Zone III (Basic Wind Zone Map); or

(B) The wind pressures specified in the following table:

TABLE OF DESIGN WIND PRESSURES

Element	Wind zone II design wind speed 100 MPH	Wind zone III design wind speed 110 MPH
Anchorage for lateral and vertical stability (See §3280.306(a)):		
Net Horizontal Drag ^{1,2} :	³ ±39 PSF	³ ±47 PSF
Uplift ⁴ :	⁵ - 27 PSF	- 32 PSF
Main wind force resisting system:		
Shearwalls, Diaphragms and their Fastening and Anchorage Systems ^{1,2}	±39 PSF	±47 PSF
Ridge beams and other Main Roof Support Beams (Beams supporting expanding room sections, etc.)	- 30 PSF	- 36 PSF
Components and cladding:		
Roof trusses ⁴ in all areas; trusses shall be doubled within 3'-0' from each end of the roof	⁵ - 39 PSF	⁵ - 47 PSF
Exterior roof coverings, sheathing and fastenings ^{4,6,7} in all areas except the following	⁵ - 39 PSF	⁵ - 47 PSF
Within 3'-0' from each gable end (overhang at end wall) of the roof or endwall if no overhang is provided ^{4,6,7}	⁵ - 73 PSF	⁵ - 89 PSF
Within 3'-0' from the ridge and eave (overhang at sidewall) or sidewall if no eave is provided ^{4,6,7}	⁵ - 51 PSF	⁵ - 62 PSF
Eaves (Overhangs at Sidewalls) ^{4,6,7}	⁵ - 51 PSF	⁵ - 62 PSF
Gables (Overhangs at Endwalls) ^{4,6,7}	⁵ - 73 PSF	⁵ - 89 PSF
Wall studs in sidewalls and endwalls, exterior windows and sliding glass doors (glazing and framing), exterior coverings, sheathing and fastenings ⁸ :		
Within 3'-0' from each corner of the sidewall and endwall	±48 PSF	±58 PSF
All other areas	±38 PSF	±46 PSF

NOTES:

¹ The net horizontal drag of ±39 PSF to be used in calculating Anchorage for Lateral and Vertical Stability and for the design of Main Wind Force Resisting Systems is based on a distribution of wind pressures of +0.8 or +24 PSF to the windward wall and -0.5 or -15 PSF to the leeward wall.

² Horizontal drag pressures need not be applied to roof projections when the roof slope does not exceed 20 degrees.

³ + sign would mean pressures are acting towards or on the structure; - sign means pressures are acting away from the structure; ±sign means forces can act in either direction, towards or away from the structure.

⁴ Design values in this "Table" are only applicable to roof slopes between 10 degrees (nominal 2/12 slope) and 30 degrees.

⁵ The design uplift pressures are the same whether they are applied normal to the surface of the roof or to the horizontal projection of the roof.

⁶ Shingle roof coverings that are secured with 6 fasteners per shingle through an underlayment which is cemented to a 3/8" structural rated roof sheathing need not be evaluated for these design wind pressures.

⁷ Structural rated roof sheathing that is at least 3/8" in thickness, installed with the long dimension perpendicular to roof framing supports, and secured with fasteners at 4" on center within 3'-0' of each gable end or endwall if no overhang is provided and 6" on center in all other areas, need not be evaluated for these design wind pressures.

⁸ Exterior coverings that are secured at 6" o.c. to a 3/8" structural rated sheathing that is fastened to wall framing members at 6" on center need not be evaluated for these design wind pressures.

(iii) One-piece metal roofing capable of resisting the design wind pressures for “Components and Cladding: (Exterior roof coverings)” in the Table for Design Wind Pressures in this section is allowed to be used without structural sheathing, provided the metal roofing is tested using procedures that have been approved by HUD and that meet all requirements of §§3280.303(c) and (g) and 3280.401.

(2) *Wind loads—zone designations.* The Wind Zone and specific wind design load requirements are determined by the fastest basic wind speed (mph) within each Zone and the intended location, based on the Basic Wind Zone Map, as follows:

(i) *Wind Zone I.* Wind Zone I consists of those areas on the Basic Wind Zone Map that are not identified in paragraphs (c)(2)(ii) or (iii) of this section as being within Wind Zone II or III, respectively.

(ii) *Wind Zone II.*....100 mph. The following areas are deemed to be within Wind Zone II of the Basic Wind Zone Map:

Local governments: The following local governments listed by State (counties, unless specified otherwise):

Alabama: Baldwin and Mobile.

Florida: All counties except those identified in paragraph (c)(1)(i)(C) of this section as within Wind Zone III.

Georgia: Bryan, Camden, Chatham, Glynn, Liberty, McIntosh.

Louisiana: Parishes of Acadia, Allen, Ascension, Assumption, Calcasieu, Cameron, East Baton Rouge, East Feliciana, Evangeline, Iberia, Iberville, Jefferson Davis, Lafayette, Livingston, Pointe Coupee, St. Helena, St. James, St. John the Baptist, St. Landry, St. Martin, St. Tammany, Tangipahoa, Vermillion, Washington, West Baton Rouge, and West Feliciana.

Maine: Hancock and Washington.

Massachusetts: Barnstable, Bristol, Dukes, Nantucket, and Plymouth.

Mississippi: George, Hancock, Harrison, Jackson, Pearl River, and Stone.

North Carolina: Beaufort, Brunswick, Camden, Chowan, Columbus, Craven, Currituck, Jones, New Hanover, Onslow, Pamlico, Pasquotank, Pender, Perquimans, Tyrrell, and Washington.

South Carolina: Beaufort, Berkeley, Charleston, Colleton, Dorchester, Georgetown, Horry, Jasper, and Williamsburg.

Texas: Aransas, Brazoria, Calhoun, Cameron, Chambers, Galveston, Jefferson, Kenedy, Kleberg, Matagorda, Nueces, Orange, Refugio, San Patricio, and Willacy.

Virginia: Cities of Chesapeake, Norfolk, Portsmouth, Princess Anne, and Virginia Beach.

(iii) *Wind Zone III.*....110 mph. The following areas are considered to be within Wind Zone III of the Basic Wind Zone Map:

(A) *States and Territories:* The entire State of Hawaii, the coastal regions of Alaska (as determined by the 90 mph isotach on the ANSI/ASCE 7-88 map), and all of the U.S. Territories of American Samoa, Guam, Northern Mariana Islands, Puerto Rico, Trust Territory of the Pacific Islands, and the United States Virgin Islands.

(B) *Local governments:* The following local governments listed by State (counties, unless specified otherwise):

Florida: Broward, Charlotte, Collier, Dade, Franklin, Gulf, Hendry, Lee, Martin, Manatee, Monroe, Palm Beach, Pinellas, and Sarasota.

Louisiana: Parishes of Jefferson, La Fourche, Orleans, Plaquemines, St. Bernard, St. Charles, St. Mary, and Terrabonne.

North Carolina: Carteret, Dare, and Hyde.

(iv) *Consideration of local requirements.* For areas where local building code requirements exceed the design wind speed requirements of these standards, the Department will consider the adoption through rulemaking of the more stringent requirements of the State or local building authority.

(3) *Snow and roof loads.* (i) Flat, curved and pitched roofs shall be designed to resist the following live loads, applied downward on the horizontal projection as appropriate for the design zone marked on the manufactured home:

Zone (see Map in § 3280.305(c)(4))	Pounds per square foot
North Zone	40
Middle Zone	30
South Zone	20

(A) *North Roof Load Zone.* The following counties in each of the following states are deemed to be within the North Roof Load Zone:

Maine—Aroostook, Piscataquis, Somerset, Penobscot, Waldo, Knox, Hancock, and Washington.

Alaska—All Counties

Office of Asst. Sec. for Housing, HUD

§ 3280.305

(B) *Middle Roof Load Zone.* The following states are deemed to be within the Middle Roof Load Zone:

States	Counties			
South Dakota	Grant Codington Deuel Hamlin Kingsbury	Brookings Miner Lake Moody McCook	Hanson Minnehaha Hutchinson Turner	Lincoln Yankton Union Clay
Minnesota	Koochiching Itasca Hubbard Cass Crow Wing Aitkin St. Louis Lake Cook Carlton Pine Wadena Todd Morrison Douglas Grant Stevens Pope	Stearns Swift Kandiyohi Meekeer Wright Lac qui Parle Chippewa Yellow Medicine Mille Lacs Kanabec Benton Isanti Sherburne Anoka Chisapo Washington Hennepin Ramsey	Renville McLeod Carver Dakota Goodhue Wabasha Winona Fillmore Mower Olmsted Dodge Rice Steele Freeborn Faribault Waseca Le Sueur Scott	Sibley Nicollet Blue Earth Martin Watonwan Brown Redwood Lyon Lincoln Pipestone Murray Cottonwood Jackson Nobles Rock
Iowa	Hancock Lyon Osceola Dickinson Emmet Kossuth Winnebago Worth	Mitchell Howard Chickasaw Butler Floyd Cerro Gordo Franklin Hardin	Hamilton Webster Calhoun Sac Ida Humboldt Pocahontas Palo Alto	Buena Vista Cherokee Plymouth Sioux O'Brien Clay Wright
Wisconsin	Douglas Bayfield Ashland Iron Vilas Forest Florence Marinette St. Croix	Oconto Menominee Langlade Marathon Clark Jackson Trempealeau Buffalo	Pepin Pierce Dunn Eau Claire Chippewa Rusk Barron Taylor	Lincoln Oneida Polk Burnett Washburn Sawyer Price Door
Michigan	Houghton Baraga Marquette Alger Luce Chippewa Keweenaw Ontonagon Gogebic	Iron Dickinson Menominee Delta Schoolcraft Mackinac Cheyboygan Emmet Crawford	Presque Isle Charlevoix Montmorency Alpena Alcona Ogemaw Roscommon Missaukee	Wexford Benzie Grand Traverse Kalkaska Oscoda Otsego Leelanau Antrim
New York	St. Lawrence Franklin Clinton Essex Hamilton Warren Saratoga Washington	Herkimer Lewis Oswego Jefferson Oneida Fulton Montgomery Schenectady	Onondaga Madison Cayuga Seneca Wayne Ontario Yates Livingston	Genesee Orleans Niagara Erie Wyoming Monroe
Massachusetts	Essex			
Maine	Franklin Oxford	Kennebec Androscoggin	Lincoln Sagadahoc	Cumberland York
Montana	All Counties			
Idaho	All Counties			

§ 3280.305

24 CFR Ch. XX (4–1–11 Edition)

States	Counties			
Colorado	All Counties			
Wyoming	All Counties			
Utah	All Counties			
Vermont	Franklin Grand Isle Lamoille	Orleans Essex Chittenden	Caledonia Washington Orange	Addison Rutland Windsor
New Hampshire	All Counties			

(C) *South Roof Load Zone.* The states and counties that are not listed for the North Roof Load Zone in paragraph (c)(3)(i)(A) of this section, or the Middle Roof Load Zone in paragraph (c)(3)(i)(B) of this section, are deemed to be within the South Roof Load Zone.

(ii) For exposures in areas (mountainous or other) where snow or wind records or experience indicate significant differences from the loads stated above, the Department may establish more stringent requirements for homes known to be destined for such areas. For snow loads, such requirements are to be based on a roof snow load of 0.6 of the ground snow load for areas exposed to wind and a roof snow load of 0.8 of the ground snow load for sheltered areas.

(iii) Eaves and cornices shall be designed for a net uplift pressure of 2.5 times the design uplift wind pressure cited in §3280.305(c)(1)(i) for Wind Zone

I, and for the design pressures cited in §3280.305(c)(1)(ii) for Wind Zones II and III.

(iv) Skylights must be capable of withstanding roof loads as specified in paragraphs (c)(3)(i) or (c)(3)(ii) of this section. Skylights must be listed and tested in accordance with AAMA 1600/ I.S.7-00, 2003, Voluntary Specification for Skylights.

(4) *Data plate requirements.* The Data Plate posted in the manufactured home (see §3280.5) shall designate the wind and roof load zones or, if designed for higher loads, the actual design external snow and wind loads for which the home has been designed. The Data Plate shall include reproductions of the Load Zone Maps shown in this paragraph (c)(4), with any related information. The Load Zone Maps shall be not less than either 3½ in. by 2¼ in., or one-half the size illustrated in the Code of Federal Regulations.

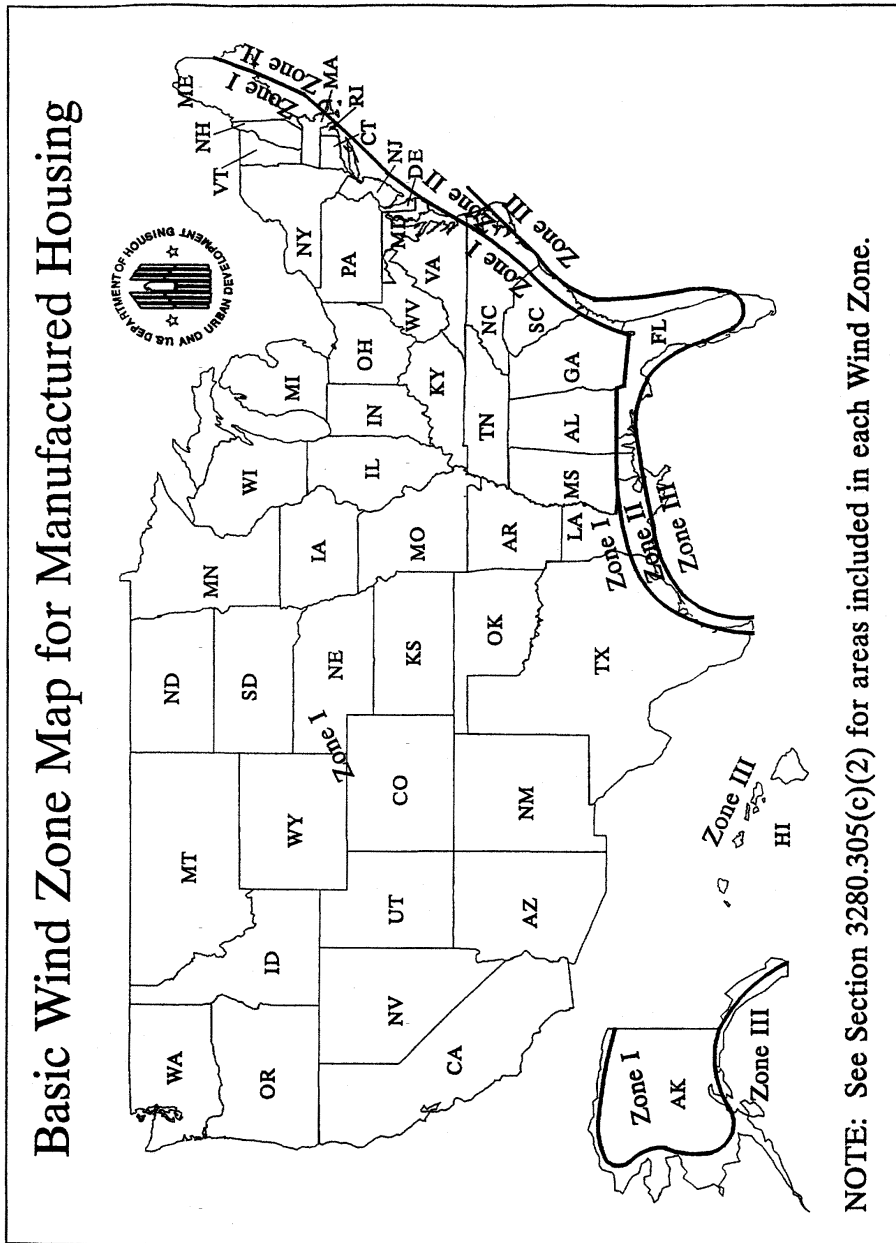

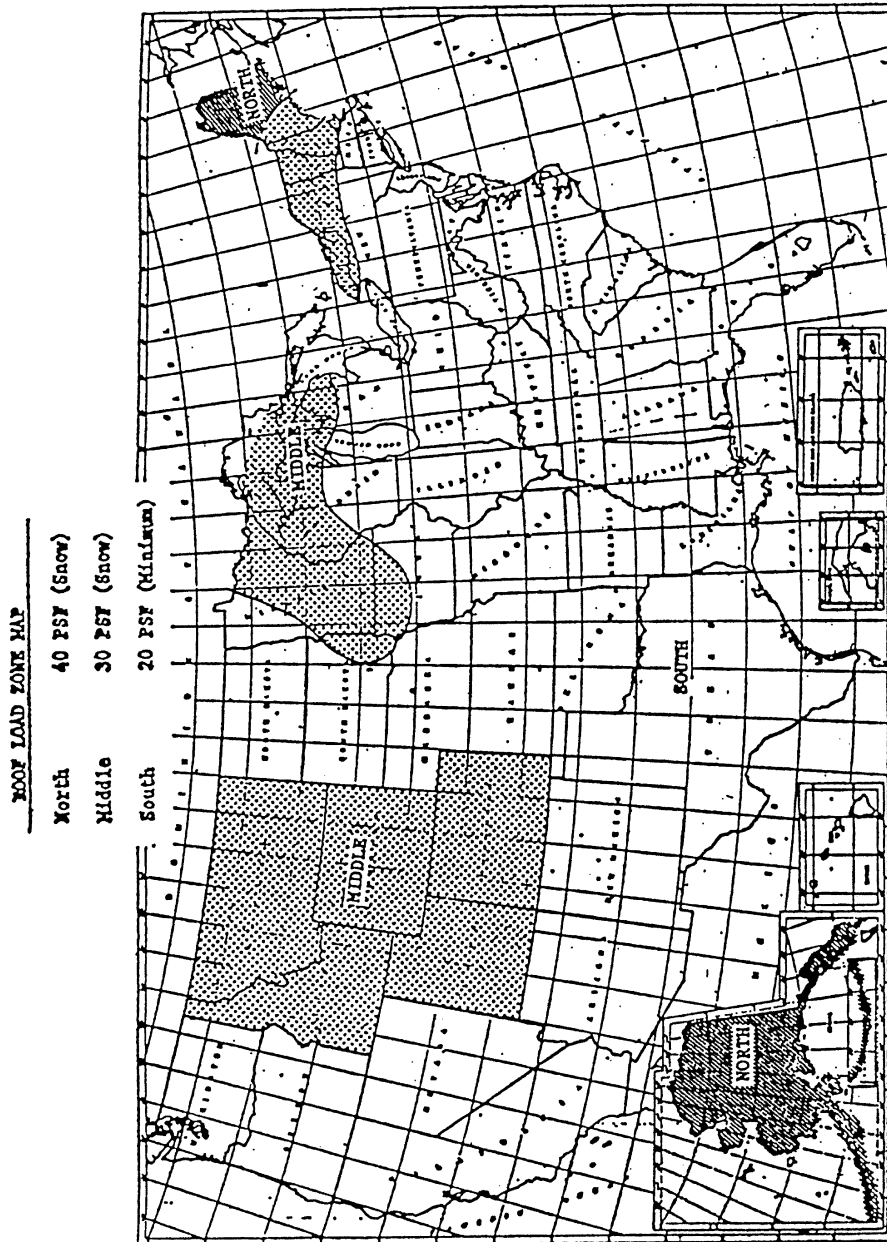

(d) *Design load deflection.* (1) When a structural assembly is subjected to total design live loads, the deflection for structural framing members shall not exceed the following (where L equals the clear span between supports or two times the length of a cantilever):

Floor—L/240
 Roof and ceiling—L/180
 Headers, beams, and girders (vertical load)—
 L/180
 Walls and partitions—L/180

(2) The allowable eave or cornice deflection for uplift is to be measured at the design uplift load of 9 psf for Wind Zone I, and at the design uplift pressure cited in paragraph (c)(1)(ii) of this section for Wind Zones II and III. The allowable deflection shall be $(2 \times L_c)/180$, where L_c is the measured horizontal eave projection from the wall.

(e) *Fastening of structural systems.* (1) Roof framing must be securely fastened to wall framing, walls to floor structure, and floor structure to chassis, to secure and maintain continuity between the floor and chassis in order to resist wind overturning, uplift, and sliding, and to provide continuous load paths for these forces to the foundation or anchorage system. The number and type of fasteners used must be capable of transferring all forces between elements being joined.

(2) For Wind Zone II and Wind Zone III, roof framing members must be securely fastened at the vertical bearing points to resist design overturning, uplift, and sliding forces. When engineered connectors are not installed, roof framing members must be secured at the vertical bearing points to wall framing members (studs), and wall framing members (studs) must be secured to floor framing members, with 0.016 inch base metal, minimum steel strapping or engineered connectors, or by a combination of 0.016 inch base metal, minimum steel strapping or engineered connectors, and structural-rated wall sheathing that overlaps the roof and floor system if substantiated by structural analysis or by suitable load tests. Steel strapping or engineered connectors are to be installed at a maximum spacing of 24 inches on center in Wind Zone II, and 16 inches on center in Wind Zone III. *Exception:* Where substantiated by structural analysis or suitable load tests, the 0.016 inch base metal minimum steel strapping or engineered connectors may be omitted at the roof to wall and/or wall to floor connections, when structural rated sheathing that overlaps the roof and wall and/or wall and floor is capa-

ble of resisting the applicable design wind loads.

(f) *Walls.* The walls shall be of sufficient strength to withstand the load requirements as defined in §3280.305(c) of this part, without exceeding the deflections as specified in §3280.305(d). The connections between the bearing walls, floor, and roof framework members shall be fabricated in such a manner as to provide support for the material used to enclose the manufactured home and to provide for transfer of all lateral and vertical loads to the floor and chassis.

(1) Except where substantiated by engineering analysis or tests, studs shall not be notched or drilled in the middle one-third of their length.

(2) Interior walls and partitions shall be constructed with structural capacity adequate for the intended purpose and shall be capable of resisting a horizontal load of not less than five pounds per square foot. An allowable stress increase of 1.33 times the permitted published design values may be used in the design of wood framed interior partitions. Finish of walls and partitions shall be securely fastened to wall framing.

(g) *Floors.* (1) Floor assemblies shall be designed in accordance with accepted engineering practice standards to support a minimum uniform live load of 40 lb/ft² plus the dead load of the materials. In addition (but not simultaneously), floors shall be able to support a 200-pound concentrated load on a one-inch diameter disc at the most critical location with a maximum deflection not to exceed one-eighth inch relative to floor framing. Perimeter wood joists of more than six inches depth shall be stabilized against overturning from superimposed loads as follows: at ends by solid blocking not less than two-inch thickness by full depth of joist, or by connecting to a continuous header not less than two-inch thickness and not less than the depth of the joist with connecting devices; at eight-foot maximum intermediate spacing by solid blocking or by wood cross-bridging of not less than one inch by three inches, metal cross-bridging of equal strength, or by other approved methods.

§ 3280.305

24 CFR Ch. XX (4-1-11 Edition)

(2) Wood, wood fiber or plywood floors or subfloors in kitchens, bathrooms (including toilet compartments), laundry areas, water heater compartments, and any other areas subject to excessive moisture shall be moisture resistant or shall be made moisture resistant by sealing or by an overlay of nonabsorbent material applied with water-resistant adhesive. Use of one of the following methods would meet this requirement:

(i) Sealing the floor with a water-resistant sealer; or

(ii) Installing an overlay of a non-absorbent floor covering material applied with water-resistant adhesive; or

(iii) Direct application of a water-resistant sealer to the exposed wood floor area when covered with a non-absorbent overlay; or

(iv) The use of a non-absorbent floor covering which may be installed without a continuous application of a water-resistant adhesive or sealant when the floor covering meets the following criteria:

(A) The covering is a continuous membrane with any seams or patches seam bonded or welded to preserve the continuity of the floor covering; and

(B) The floor is protected at all penetrations in these areas by sealing with a compatible water-resistant adhesive or sealant to prevent moisture from migrating under the nonabsorbent floor covering; and

(C) The covering is fastened around the perimeter of the subfloor in accordance with the floor covering manufacturer's instructions; and,

(D) The covering is designed to be installed to prevent moisture penetration without the use of a water-resistant adhesive or sealer except as required in this paragraph (g). The vertical edges of penetrations for plumbing shall be covered with a moisture-resistant adhesive or sealant. The vertical penetrations located under the bottom plates of perimeter walls of rooms, areas, or compartments are not required to be sealed; this does not include walls or partitions within the rooms or areas.

(3) Wood panel products used as floor or subfloor materials on the exterior of the home, such as in recessed entryways, must be rated for exterior exposure and protected from moisture

by sealing or applying nonabsorbent overlay with water resistant adhesive.

(4) Carpet or carpet pads shall not be installed under concealed spaces subject to excessive moisture, such as plumbing fixture spaces, floor areas under installed laundry equipment. Carpet may be installed in laundry space provided:

(i) The appliances are not provided;

(ii) The conditions of paragraph (g)(2) of this section are followed; and

(iii) Instructions are provided to remove carpet when appliances are installed.

(5) Except where substantiated by engineering analysis or tests:

(i) Notches on the ends of joists shall not exceed one-fourth the joist depth.

(ii) Holes bored in joists shall not be within 2 inches of the top or bottom of the joist, and the diameter of any such hole shall not exceed one-third the depth of the joist.

(iii) Notches in the top or bottom of the joists shall not exceed one-sixth the depth and shall not be located in the middle third of the span.

(6) Bottom board material (with or without patches) shall meet or exceed the level of 48 inch-pounds of puncture resistance as tested by the Beach Puncture Test in accordance with Standard Test Methods for Puncture and Stiffness of Paperboard, and Corrugated and Solid Fiberboard, ASTM D-781-1968 (73). The material shall be suitable for patches and the patch life shall be equivalent to the material life. Patch installation instruction shall be included in the manufactured home manufacturer's instructions.

(h) *Roofs.* (1) Roofs shall be of sufficient strength to withstand the load requirements as defined in §3280.305 (b) and (c) without exceeding the deflections specified in §3280.305(d). The connections between roof framework members and bearing walls shall be fabricated in such a manner to provide for the transfer of design vertical and horizontal loads to the bearing walls and to resist uplift forces.

(2) Roofing membranes shall be of sufficient rigidity to prevent deflection which would permit ponding of water or separation of seams due to wind, snow, ice, erection or transportation forces.

(3) Cutting of roof framework members for passage of electrical, plumbing or mechanical systems shall not be allowed except where substantiated by engineering analysis.

(4) All roof penetrations for electrical, plumbing or mechanical systems shall be properly flashed and sealed. In addition, where a metal roof membrane is penetrated, a wood backer shall be installed. The backer plate shall be not less than $\frac{3}{16}$ inch plywood, with exterior glues, secured to the roof framing system beneath the metal roof, and shall be of a size to assure that all screws securing the flashing are held by the backer plate.

(i) *Frame construction.* The frame shall be capable of transmitting all design loads to stabilizing devices without exceeding the allowable load and deflections of this section. The frame shall also be capable of withstanding the effects of transportation shock and vibration without degradation as required by subpart J.

(1) [Reserved]

(2) *Protection of metal frames against corrosion.* Metal frames shall be made corrosion resistant or protected against corrosion. Metal frames may be protected against corrosion by painting.

(j) *Welded connections.* (1) All welds must be made in accordance with the applicable provisions of the Specification for Structural Steel Buildings, Allowable Stress Design and Plastic Design, AISC-S335, 1989; the Specification for the Design of Cold-Formed Steel Structural Members, AISI, 1996; and the Specification for the Design of Cold-Formed Stainless Steel Structural Members, SEI/ASCE 8-02, 2002.

(2) Regardless of the provisions of any reference standard contained in this subpart, deposits of weld slag or flux shall be required to be removed only from welded joints at the following locations:

- (i) Drawbar and coupling mechanisms;
- (ii) Main member splices, and

(iii) Spring hanger to main member connections.

[40 FR 58752, Dec. 18, 1975. Redesignated at 44 FR 20679, Apr. 6, 1979, as amended at 44 FR 66195, Nov. 19, 1979; 52 FR 4582, Feb. 12, 1987; 58 FR 55006, Oct. 25, 1993; 59 FR 2469, Jan. 14, 1994; 59 FR 15113, 15114, Mar. 31, 1994; 62 FR 54547, Oct. 20, 1997; 70 FR 72043, Nov. 30, 2005; 71 FR 19638, Apr. 17, 2006]

§ 3280.306 Windstorm protection.

(a) *Provisions for support and anchoring systems.* Each manufactured home shall have provisions for support/anchoring or foundation systems that, when properly designed and installed, will resist overturning and lateral movement (sliding) of the manufactured home as imposed by the respective design loads. For Wind Zone I, the design wind loads to be used for calculating resistance to overturning and lateral movement shall be the simultaneous application of the wind loads indicated in § 3280.305(c)(1)(i), increased by a factor of 1.5. The 1.5 factor of safety for Wind Zone I is also to be applied simultaneously to both the vertical building projection, as horizontal wind load, and across the surface of the full roof structure, as uplift loading. For Wind Zones II and III, the resistance shall be determined by the simultaneous application of the horizontal drag and uplift wind loads, in accordance with § 3280.305(c)(1)(ii). The basic allowable stresses of materials required to resist overturning and lateral movement shall not be increased in the design and proportioning of these members. No additional shape or location factors need to be applied in the design of the tiedown system. The dead load of the structure may be used to resist these wind loading effects in all Wind Zones.

(1) The provisions of this section shall be followed and the support and anchoring systems shall be designed by a Registered Professional Engineer or Architect.

(2) The manufacturer of each manufactured home is required to make provision for the support and anchoring systems but is not required to provide the anchoring equipment or stabilizing devices. When the manufacturer's installation instructions provide for the main frame structure to be used as the

points for connection of diagonal ties, no specific connecting devices need be provided on the main frame structure.

(b) *Contents of instructions.* (1) The manufacturer must provide printed instructions with each manufactured home that specify the location and required capacity of stabilizing devices on which the home's design is based. The manufacturer must identify by paint, label, decal stencil, or other means: the location of each column support pier location required along the marriage line(s) of multi-section manufactured homes; each pier location required along the perimeter of the home; each required shear wall pier support; and any other special pier support locations specified in the manufacturer's printed instructions. Such identifications must be visible after the home is installed. The manufacturer must provide drawings and specifications, certified by a registered professional engineer or architect, that indicate at least one acceptable system of anchoring, including the details or required straps or cables, their end connections, and all other devices needed to transfer the wind loads from the manufactured home to an anchoring or foundation system.

(2) For anchoring systems, the instructions shall indicate:

(i) The minimum anchor capacity required;

(ii) That anchors should be certified by a professional engineer, architect, or a nationally recognized testing laboratory as to their resistance, based on the maximum angle of diagonal tie and/or vertical tie loading (see paragraph (c)(3) of this section) and angle of anchor installation, and type of soil in which the anchor is to be installed;

(iii) That ground anchors are to be embedded below the frost line, unless the foundation system is frost-protected in accordance with §§ 3285.312(b) and 3285.404 of the Model Manufactured Home Installation Standards in this chapter.

(iv) That ground anchors must be installed to their full depth, and stabilizer plates must be installed in accordance with the ground anchor listing or certification to provide required resistance to overturning and sliding.

(v) That anchoring equipment should be certified by a registered professional engineer or architect to resist these specified forces in accordance with testing procedures in ASTM Standard Specification D3953-91, Standard Specification for Strapping, Flat Steel and Seals.

(c) *Design criteria.* The provisions made for anchoring systems shall be based on the following design criteria for manufactured homes.

(1) The minimum number of ties provided per side of each home shall resist design wind loads required in § 3280.305(c)(1).

(2) Ties shall be as evenly spaced as practicable along the length of the manufactured home, with not more than two (2) feet open-end spacing on each end.

(3) Vertical ties or straps shall be positioned at studs. Where a vertical tie and a diagonal tie are located at the same place, both ties may be connected to a single anchor, provided that the anchor used is capable of carrying both loadings, simultaneously.

(4) Add-on sections of expandable manufactured homes shall have provisions for vertical ties at the exposed ends.

(d) *Requirements for ties.* Manufactured homes in Wind Zone I require only diagonal ties. These ties shall be placed along the main frame and below the outer side walls. All manufactured homes designed to be located in Wind Zones II and III shall have a vertical tie installed at each diagonal tie location.

(e) *Protection requirements.* Protection shall be provided at sharp corners where the anchoring system requires the use of external straps or cables. Protection shall also be provided to minimize damage to siding by the cable or strap.

(f) *Anchoring equipment—load resistance.* Anchoring equipment shall be capable of resisting an allowable working load equal to or exceeding 3,150 pounds and shall be capable of withstanding a 50 percent overload (4,725 pounds total) without failure of either the anchoring equipment or the attachment point on the manufactured home.

(g) *Anchoring equipment—weatherization.* Anchoring equipment exposed to

weathering shall have a resistance to weather deterioration at least equivalent to that provided by a coating of zinc on steel of not less than 0.30 ounces per square foot of surface coated, and in accordance with the following:

(1) Slit or cut edges of zinc-coated steel strapping do not need to be zinc coated.

(2) Type 1, Finish B, Grade 1 steel strapping, 1-1/4 inches wide and 0.035 inches in thickness, certified by a registered professional engineer or architect as conforming with ASTM Standard Specification D3953-91, Standard Specification for Strapping, Flat Steel, and Seals.

[40 FR 58752, Dec. 18, 1975. Redesignated at 44 FR 20679, Apr. 6, 1979, as amended at 52 FR 4583, Feb. 12, 1987; 59 FR 2473, Jan. 14, 1994; 70 FR 72045, Nov. 30, 2005; 72 FR 59362, Oct. 19, 2007]

§ 3280.307 Resistance to elements and use.

(a) Exterior coverings shall be of moisture and weather resistive materials attached with corrosion resistant fasteners to resist wind, snow and rain. Metal coverings and exposed metal structural members shall be of corrosion resistant materials or shall be protected to resist corrosion. All joints between portions of the exterior covering shall be designed, and assembled to protect against the infiltration of air and water, except for any designed ventilation of wall or roof cavity.

(b) Joints between dissimilar materials and joints between exterior coverings and frames of openings shall be protected with a compatible sealant suitable to resist infiltration of air or water.

(c) Where adjoining materials or assemblies of materials are of such nature that separation can occur due to expansion, contraction, wind loads or other loads induced by erection or transportation, sealants shall be of a type that maintains protection against infiltration or penetration by air, moisture or vermin.

(d) Exterior surfaces shall be sealed to resist the entrance of rodents.

§ 3280.308 Formaldehyde emission controls for certain wood products.

(a) *Formaldehyde emission levels.* All plywood and particleboard materials bonded with a resin system or coated with a surface finish containing formaldehyde shall not exceed the following formaldehyde emission levels when installed in manufactured homes:

(1) Plywood materials shall not emit formaldehyde in excess of 0.2 parts per million (ppm) as measured by the air chamber test method specified in § 3280.406.

(2) Particleboard materials shall not emit formaldehyde in excess of 0.3 ppm as measured by the air chamber test specified in § 3280.406.

(b) *Product certification and continuing qualification.* All plywood and particleboard materials to be installed in manufactured homes which are bonded with a resin system or coated with a surface finish containing formaldehyde, other than an exclusively phenol-formaldehyde resin system or finish, shall be certified by a nationally recognized testing laboratory as complying with paragraph (a) of this section.

(1) Separate certification shall be done for each plant where the particleboard is produced or where the plywood or particleboard is surface-finished.

(2) To certify plywood or particleboard, the testing laboratory shall witness or conduct the air chamber test specified in § 3280.406 on randomly selected panels initially and at least quarterly thereafter.

(3) The testing laboratory must approve a written quality control plan for each plant where the particleboard is produced or finished or where the plywood is finished. The quality control plan must be designed to assure that all panels comply with paragraph (a) of this section. The plan must establish ongoing procedures to identify increases in the formaldehyde emission characteristics of the finished product resulting from the following changes in production.

(i) In the case of plywood:

(A) The facility where the unfinished panels are produced is changed;

§ 3280.309

24 CFR Ch. XX (4-1-11 Edition)

(B) The thickness of the panels is changed so that the panels are thinner; or

(C) The grooving pattern on the panels is changed so that the grooves are deeper or closer together.

(ii) In the case of particleboard:

(A) The resin formulation is changed so that the formaldehyde-to-urea ratio is increased;

(B) The amount of formaldehyde resin used is increased; or

(C) The press time is decreased.

(iii) In the case of plywood or particleboard:

(A) The finishing or top coat is changed and the new finishing or top coat has a greater formaldehyde content; or

(B) The amount of finishing or top coat used on the panels is increased, provided that such finishing or top coat contains formaldehyde.

(4) The testing laboratory shall periodically visit the plant to monitor quality control procedures to assure that all certified panels meet the standard.

(5) To maintain its certification, plywood or particleboard must be tested by the air chamber test specified in § 3280.406 whenever one of the following events occurs:

(i) In the case of particleboard, the resin formulation is changed so that the formaldehyde-to-urea ratio is increased; or

(ii) In the case of particleboard or plywood, the finishing or top coat is changed and the new finishing or top coat contains formaldehyde; or

(iii) In the case of particleboard or plywood, the testing laboratory determines that an air chamber test is necessary to assure that panels comply with paragraph (a) of this section.

(6) In the event that an air chamber test measures levels of formaldehyde from plywood or particleboard in excess of those permitted under paragraph (a) of this section, then the tested product's certification immediately lapses as of the date of production of the tested panels. No panel produced on the same date as the tested panels or on any day thereafter may be used or certified for use in manufactured homes.

(i) Provided, however, that a new product certification may be obtained by testing randomly selected panels which were produced on any day following the date of production of the tested panels. If such panels pass the air chamber test specified in § 3280.406, then the plywood or particleboard produced on that day and subsequent days may be used and certified for use in manufactured homes.

(ii) Provided further, that plywood or particleboard produced on the same day as the tested panels, and panels produced on subsequent days, if not certified pursuant to paragraph (b)(4)(i) of this section, may be used in manufactured homes only under the following circumstances:

(A) Each panel is treated with a scavenger, sealant, or other means of reducing formaldehyde emissions which does not adversely affect the structural quality of the product; and

(B) Panels randomly selected from the treated panels are tested by and pass the air chamber test specified in § 3280.406.

(c) *Panel identification.* Each plywood and particleboard panel to be installed in manufactured homes which is bonded or coated with a resin system containing formaldehyde, other than an exclusively phenol-formaldehyde resin system, shall be stamped or labeled so as to identify the product manufacturer, date of production and/or lot number, and the testing laboratory certifying compliance with this section.

(d) *Treatment after certification.* If certified plywood or particleboard subsequently is treated with paint, varnish, or any other substance containing formaldehyde, then the certification is no longer valid. In such a case, each stamp or label placed on the panels pursuant to paragraph (c) of this section must be obliterated. In addition, the treated panels may be recertified and reidentified in accordance with paragraphs (b) and (c) of this section.

[49 FR 32011, Aug. 9, 1984]

§ 3280.309 Health Notice on formaldehyde emissions.

(a) Each manufactured home shall have a Health Notice on formaldehyde emissions prominently displayed in a

temporary manner in the kitchen (i.e., countertop or exposed cabinet face). The Notice shall read as follows:

IMPORTANT HEALTH NOTICE

Some of the building materials used in this home emit formaldehyde. Eye, nose, and throat irritation, headache, nausea, and a variety of asthma-like symptoms, including shortness of breath, have been reported as a result of formaldehyde exposure. Elderly persons and young children, as well as anyone with a history of asthma, allergies, or lung problems, may be at greater risk. Research is continuing on the possible long-term effects of exposure to formaldehyde.

Reduced ventilation resulting from energy efficiency standards may allow formaldehyde and other contaminants to accumulate in the indoor air. Additional ventilation to dilute the indoor air may be obtained from a passive or mechanical ventilation system offered by the manufacturer. Consult your dealer for information about the ventilation options offered with this home.

High indoor temperatures and humidity raise formaldehyde levels. When a home is to be located in areas subject to extreme summer temperatures, an air-conditioning system can be used to control indoor temperature levels. Check the comfort cooling certificate to determine if this home has been equipped or designed for the installation of an air-conditioning system.

If you have any questions regarding the health effects of formaldehyde, consult your doctor or local health department.

(b) The Notice shall be legible and typed using letters at least ¼ inch in size. The title shall be typed using letters at least ¾ inch in size.

(c) The Notice shall not be removed by any party until the entire sales transaction has been completed (refer to part 3282—Manufactured Home Procedural and Enforcement Regulations for provisions regarding a sales transaction).

(d) A copy of the Notice shall be included in the Consumer Manual (refer to part 3283—Manufactured Home Consumer Manual Requirements).

[49 FR 32012, Aug. 9, 1984, as amended at 54 FR 46049, Nov. 1, 1989; 58 FR 55007, Oct. 25, 1993]

Subpart E—Testing

§ 3280.401 Structural load tests.

Every structural assembly tested shall be capable of meeting the Proof

Load Test or the Ultimate Load Test as follows:

(a) *Proof load tests.* Every structural assembly tested must be capable of sustaining its dead load plus superimposed live loads equal to 1.75 times the required live loads for a period of 12 hours without failure. Tests must be conducted with loads applied and deflections recorded in ¼ design live load increments at 10-minute intervals until 1.25 times design live load plus dead load has been reached. Additional load shall then be applied continuously until 1.75 times design live load plus dead load has been reached. Assembly failure shall be considered as design live load deflection (or residual deflection measured 12 hours after live load removal) that is greater than the limits set in § 3280.305(d), rupture, fracture, or excessive yielding. Design live load deflection criteria do not apply when the structural assembly being evaluated does not include structural framing members. An assembly to be tested shall be of the minimum quality of materials and workmanship of the production. Each test assembly, component, or subassembly shall be identified as to type and quality or grade of material. All assemblies, components, or subassemblies qualifying under this test shall be subject to a continuing qualification testing program acceptable to HUD.

(b) *Ultimate load tests.* Ultimate load tests must be performed on a minimum of three assemblies or components to generally evaluate the structural design. Every structural assembly or component tested must be capable of sustaining its total dead load plus the design live load increased by a factor of safety of at least 2.5. A factor of safety greater than 2.5 shall be used when required by an applicable reference standard in § 3280.304(b)(1). Tests shall be conducted with loads applied and deflections recorded in ¼ design live load increments at 10-minute intervals until 1.25 times design live load plus dead load has been reached. Additional loading shall then be applied continuously until failure occurs, or the total of the factor of safety times the design live load plus the dead load is reached. Assembly failure shall be considered as design live load deflection greater than

§ 3280.402

24 CFR Ch. XX (4–1–11 Edition)

the limits set in § 3280.305(d), rupture, fracture, or excessive yielding. Design live load deflection criteria do not apply when the structural assembly being evaluated does not include structural framing members. Assemblies to be tested shall be representative of average quality or materials and workmanship of the production. Each test assembly, component, or subassembly shall be identified as to type and quality or grade of material. All assemblies, components, or subassemblies qualifying under this test shall be subject to a periodic qualification testing program acceptable to HUD.

[40 FR 58752, Dec. 18, 1975. Redesignated at 44 FR 20679, Apr. 6, 1979, as amended at 58 FR 55007, Oct. 25, 1993; 70 FR 72045, Nov. 30, 2005]

§ 3280.402 Test procedure for roof trusses.

(a) *Roof load tests.* The following is an acceptable test procedure, consistent with the provisions of § 3280.401, for roof trusses that are supported at the ends and support design loads. Where roof trusses act as support for other members, act as cantilevers, or support concentrated loads, they shall be tested accordingly.

(b) *General.* Trusses may be tested in pairs or singly in a suitable test facility. When tested singly, simulated lateral support of the test assembly may be provided, but in no case shall this lateral support exceed that which is specified for the completed manufactured home. When tested in pairs, the trusses shall be spaced at the design spacing and shall be mounted on solid support accurately positioned to give the required clear span distance (L) as specified in the design. The top and bottom chords shall be braced and covered with the material, with connec-

tions or method of attachment, as specified by the completed manufactured home.

(1) As an alternate test procedure, the top chord may be sheathed with $\frac{1}{4}$ inch by 12 inch plywood strips. The plywood strips shall be at least long enough to cover the top chords of the trusses at the designated design truss spacing. Adjacent plywood strips must be separated by at least $\frac{1}{8}$ inch. The plywood strip shall be nailed with 4d nails or equivalent staples not closer than 8 inches on center along the top chord. The bottom chords of the adjacent trusses may be either:

- (i) Unbraced,
- (ii) Laterally braced together (not cross braced) with 1"×2" stripping not closer than 24 inches on center nailed with only one 6d nail at each truss, or
- (iii) Covered with the material, with connections or methods of attachment, as specified for the completed manufactured home.

(2) Truss deflections will be measured relative to a taut wire running over the support and weighted at the end to insure constant tension or other approved methods. Deflections will be measured at the two quarter points and at midspan. Loading shall be applied to the top chord through a suitable hydraulic, pneumatic, or mechanical system, masonry units, or weights to simulate design loads. Load units for uniformly distributed loads shall be separated so that arch action does not occur, and shall be spaced not greater than 12 inches on center so as to simulate uniform loading.

(c) *Nondestructive test procedure—(1) Dead load plus live load.* (i) Noting figure A-1, measure and record initial elevation of the truss in test position at no load.

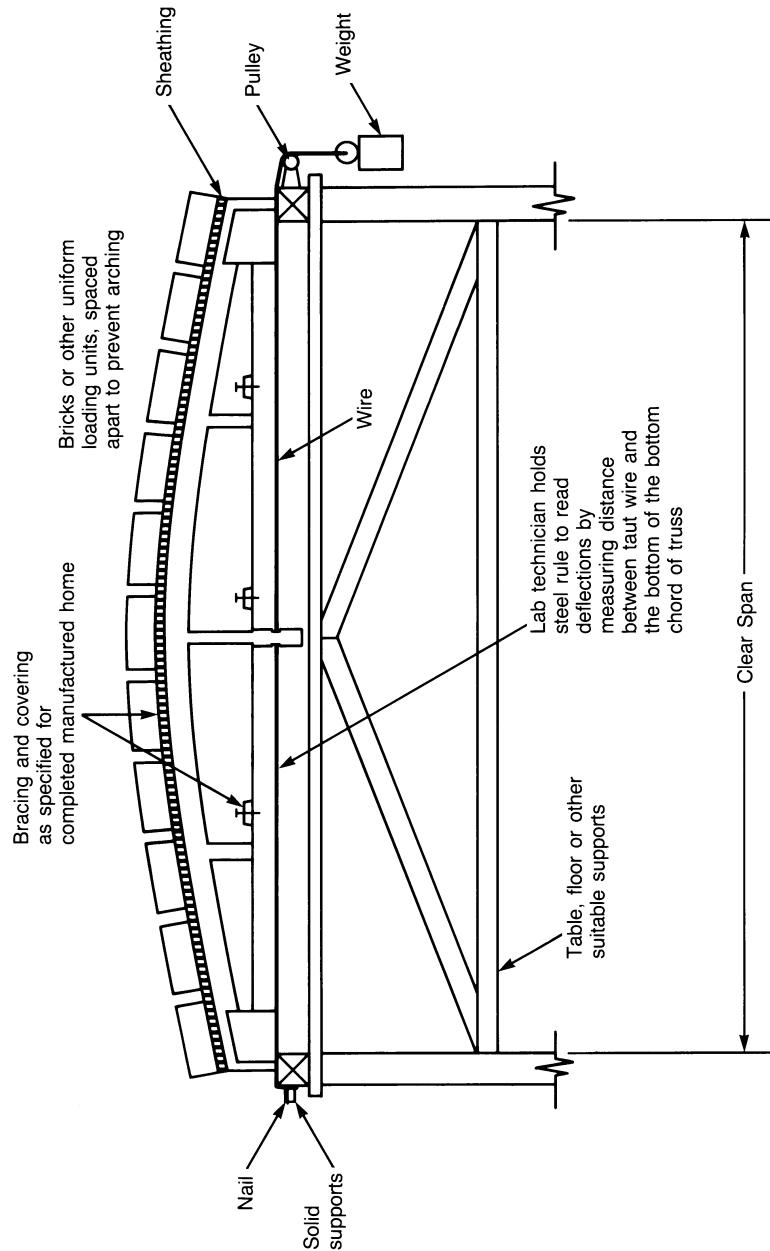

Figure A-1. Test Procedures for Roof Trusses

(ii) Apply load units to the top chord of the truss equal to the full dead load of roof and ceiling. Measure and record deflections.

(iii) Maintaining the dead load, add live load in approximate 1/4 design live load increments. Measure the deflections after each loading increment.

§ 3280.403

24 CFR Ch. XX (4-1-11 Edition)

Apply incremental loads at a uniform rate such that approximately one-half hour is required to establish the total design load condition. Measure and record the deflections five minutes after loads have been applied. The maximum deflection due to design live load (deflection measured in step (iii) minus step (ii)) shall not exceed $L/180$, where L is a clear span measured in the same units.

(iv) Continue to load truss to dead load plus 1.75 times the design live load. Maintain this loading for 12 hours and inspect the truss for failure.

(v) Remove the total superimposed live load. Trusses not recovering to at least the $L/180$ position within 12 hours shall be considered as failing.

(2) *Uplift loads.* This test shall only be required for truss designs which may be critical under uplift load conditions.

(i) Measure and record initial elevation of the truss in an inverted test position at no load. Bottom chord of the truss shall be mounted in the horizontal position.

(ii) Apply the uplift load as stated in § 3280.305(c) to the bottom chord of the truss. Measure and record the deflections 5 minutes after the load has been applied.

(iii) Continue to load the truss to 1.75 times the design uplift load. Maintain this load for 3 hours and inspect the truss for failure.

(iv) Remove applied loads and within three hours the truss must recover to at least $L/180$ position, where L is a clear span measured in the same units.

(d) *Destructive test procedure.* (1) Destructive tests shall be performed on three trusses to generally evaluate the truss design.

(2) Noting figure A-1, apply the load units to the top chord of the truss assembly equal to full dead load of roof and ceiling. Measure and record deflections. Then apply load and record deflections in $\frac{1}{4}$ design live load increments at 10-minute intervals until 1.25 times design live load plus dead load has been reached.

(3) Additional loading shall then be applied continuously until failure occurs or the factor of safety times the design live load plus the dead load is reached.

(4) Assembly failure shall be considered as design live load deflection greater than the limits set in § 3280.305(d), rupture, fracture, or excessive yielding.

(5) The assembly shall be capable of sustaining the dead load plus the applicable factor of safety times the design live load (the applicable factor of safety for wood trusses shall be taken as 2.50).

(e) Trusses qualifying under the non-destructive test procedure. Tests § 3208.402(c) (1) and (2) (when required), shall be subject to a continuing qualification testing program acceptable to the Department. Trusses qualifying under the destructive test procedures, Tests § 3280.402 (c)(2) (when required), and (d), shall be subject to periodic tests only.

[40 FR 58752, Dec. 18, 1975, as amended at 42 FR 961, Jan. 4, 1977. Redesignated at 44 FR 20679, Apr. 6, 1979, as amended at 58 FR 55008, Oct. 25, 1993]

§ 3280.403 Standard for windows and sliding glass doors used in manufactured homes.

(a) *Scope.* This section sets the requirements for prime windows and sliding glass doors except for windows used in entry doors. Windows so mounted are components of the door and thus are excluded from this standard.

(b) *Standard.* All primary windows and sliding glass doors shall comply with AAMA 1701.2-95, Voluntary Standard Primary Window and Sliding Glass Door for Utilization in Manufactured Housing, except the exterior and interior pressure tests must be conducted at the design wind loads required for components and cladding specified in § 3280.305(c)(1).

(c) *Installation.* All primary windows and sliding glass doors shall be installed in a manner which allows proper operation and provides protection against the elements (*see* § 3280.307).

(d) *Glass.* (1) Safety glazing materials, where used, shall meet ANSI Z97.1-1984, "Safety Performance Specifications and Methods of Test for Safety Glazing Materials Used in Buildings."

(2) Sealed insulating glass, where used, must meet all performance requirements for Class C in accordance

with ASTM E 774-97, Standard Specification for the Classification of the Durability of Sealed Insulating Glass Units. The sealing system must be qualified in accordance with ASTM E 773-97, Standard Test Methods for Accelerated Weathering of Sealed Insulating Glass Units. Each glass unit must be permanently identified with the name of the insulating glass manufacturer.

(e) *Certification.* All primary windows and sliding glass doors to be installed in manufactured homes must be certified as complying with AAMA 1701.2-95. This certification must be based on tests conducted at the design wind loads specified in § 3280.305(c)(1).

(1) All such windows and doors must show evidence of certification by affixing a quality certification label to the product in accordance with ANSI Z34.1-1993, Third-Party Certification Programs for Products, Processes, and Services.

(2) In determining certifiability of the products, an independent quality assurance agency shall conduct pre-production specimen tests in accordance with AAMA 1701.2-95. Further, such agency must inspect the product manufacturer's facility at least twice per year.

(f) *Protection of primary window and sliding glass door openings in high wind areas.* For homes designed to be located in Wind Zones II and III, manufacturers shall design exterior walls surrounding the primary window and sliding glass door openings to allow for the installation of shutters or other protective covers, such as plywood, to cover these openings. Although not required, the Department encourages manufacturers to provide the shutters or protective covers and to install receiving devices, sleeves, or anchors for fasteners to be used to secure the shutters or protective covers to the exterior walls. If the manufacturer does not provide shutters or other protective covers to cover these openings, the manufacturer must provide to the homeowner instructions for at least one method of protecting primary window and sliding glass door openings. This method must be capable of resisting the design wind pressures specified in § 3280.305 without taking the home

out of conformance with the standards in this part. These instructions must be included in the printed instructions that accompany each manufactured home. The instructions shall also indicate whether receiving devices, sleeves, or anchors, for fasteners to be used to secure the shutters or protective covers to the exterior walls, have been installed or provided by the manufacturer.

[52 FR 4583, Feb. 12, 1987, as amended at 52 FR 35543, Sept. 22, 1987; 58 FR 55009, Oct. 25, 1993; 59 FR 2474, Jan. 14, 1994; 70 FR 72046, Nov. 30, 2005]

§ 3280.404 Standard for egress windows and devices for use in manufactured homes.

(a) *Scope and purpose.* The purpose of this section is to establish the requirements for the design, construction, and installation of windows and approved devices intended to be used as an emergency exit during conditions encountered in a fire or similar disaster.

(b) *Performance.* Egress windows including auxiliary frame and seals, if any, shall meet all requirements of AAMA 1701.2-95, Voluntary Standard Primary Window and Sliding Glass Door for Utilization in Manufactured Housing and AAMA Standard 1704-1985, Voluntary Standard Egress Window Systems for Utilization in Manufactured Housing, except the exterior and interior pressure tests for components and cladding must be conducted at the design wind loads required by § 3280.305(c)(1).

(c) *Installation.* (1) The installation of egress windows or devices shall be installed in a manner which allows for proper operation and provides protection against the elements. (See § 3280.307.)

(2) An operational check of each installed egress window or device shall be made at the manufactured home factory. All egress windows and devices shall be openable to the minimum required dimension without binding or requiring the use of tools. Any window or device failing this check shall be repaired or replaced. A repaired window shall conform to its certification. Any repaired or replaced window or device shall pass the operational check.

(d) *Operating instructions.* Operating instructions shall be affixed to each egress window and device and carry the legend “Do Not Remove.”

(e) *Certification of egress windows and devices.* Egress windows and devices shall be listed in accordance with the procedures and requirements of AAMA Standard 1704–1985. As of January 17, 1995, this certification must be based on tests conducted at the design wind loads specified in § 3280.305(c)(1).

(f) *Protection of egress window openings in high wind areas.* For homes designed to be located in Wind Zones II and III, manufacturers shall design exterior walls surrounding the egress window openings to allow for the installation of shutters or other protective covers, such as plywood, to cover these openings. Although not required, the Department encourages manufacturers to provide the shutters or protective covers and to install receiving devices, sleeves, or anchors for fasteners to be used to secure the shutters or protective covers to the exterior walls. If the manufacturer does not provide shutters or other protective covers to cover these openings, the manufacturer must provide to the homeowner instructions for at least one method of protecting egress window openings. This method must be capable of resisting the design wind pressures specified in § 3280.305 without taking the home out of conformance with the standards in this part. These instructions must be included in the printed instructions that accompany each manufactured home. The instructions shall also indicate whether receiving devices, sleeves, or anchors, for fasteners to be used to secure the shutters or protective covers to the exterior walls, have been installed or provided by the manufacturer.

[52 FR 4583, Feb. 12, 1987, as amended at 59 FR 2474, Jan. 14, 1994; 70 FR 72046, Nov. 30, 2005]

§ 3280.405 Standard for swinging exterior passage doors for use in manufactured homes.

(a) *Introduction.* This standard applies to all exterior passage door units, excluding sliding doors and doors used for access to utilities and compartments. This standard applies only to the door

frame consisting of jambs, head and sill and the attached door or doors.

(b) *Performance requirements.* The design and construction of exterior door units must meet all requirements of AAMA 1702.2–95, Voluntary Standard Swinging Exterior Passage Door for Utilization in Manufactured Housing.

(c) *Materials and methods.* Any material or method of construction shall conform to the performance requirements as outlined in paragraph (b) of this section. Plywood shall be exterior type and preservative treated in accordance with NWWDA I.S.4–81, Water Repellent Preservative Non-Pressure Treatment for Millwork.

(d) *Exterior doors.* All swinging exterior doors shall be installed in a manner which allows proper operation and provides protection against the elements (see § 3280.307).

(e) *Certification.* All swinging exterior doors to be installed in manufactured homes must be certified as complying with AAMA 1702.2–95, Voluntary Standard Swinging Exterior Passage Door for Utilization in Manufactured Housing.

(1) All such doors must show evidence of certification by affixing a quality certification label to the product in accordance with ANSI Z34.1–1993, Third Party Certification Programs for Products, Processes, and Services.

(2) In determining certifiability of the products, an independent quality assurance agency must conduct a pre-production specimen test in accordance with AAMA 1702.2–95, Voluntary Standard Swinging Exterior Passage Door for Utilization in Manufactured Housing.

(f) *Protection of exterior doors in high wind areas.* For homes designed to be located in Wind Zones II and III, manufacturers shall design exterior walls surrounding the exterior door openings to allow for the installation of shutters or other protective covers, such as plywood, to cover these openings. Although not required, the Department encourages manufacturers to provide the shutters or protective covers and to install receiving devices, sleeves, or anchors for fasteners to be used to secure the shutters or protective covers to the exterior walls. If the manufacturer does not provide shutters or

other protective covers to cover these openings, the manufacturer must provide to the homeowner instructions for at least one method of protecting exterior door openings. This method must be capable of resisting the design wind pressures specified in § 3280.305 without taking the home out of conformance with the standards in this part. These instructions must be included in the printed instructions that accompany each manufactured home. The instructions shall also indicate whether receiving devices, sleeves, or anchors, for fasteners to be used to secure the shutters or protective covers to the exterior walls, have been installed or provided by the manufacturer.

[40 FR 58752, Dec. 18, 1975. Redesignated at 44 FR 20679, Apr. 6, 1979, as amended at 52 FR 4583, Feb. 12, 1987; 52 FR 35543, Sept. 22, 1987; 58 FR 55009, Oct. 25, 1993; 59 FR 2474, Jan. 14, 1994; 70 FR 72046, Nov. 30, 2005]

§ 3280.406 Air chamber test method for certification and qualification of formaldehyde emission levels.

(a) *Preconditioning.* Preconditioning of plywood or particleboard panels for air chamber tests shall be initiated as soon as practicable but not in excess of 30 days after the plywood or particleboard is produced or surface-finished, whichever is later, using randomly selected panels.

(1) If preconditioning is to be initiated more than two days after the plywood or particleboard is produced or surface-finished, whichever is later, the panels must be dead-stacked or airtight wrapped until preconditioning is initiated.

(2) Panels selected for testing in the air chamber shall not be taken from the top or bottom of the stack.

(b) *Testing.* Testing must be conducted in accordance with the Standard Test Method for Determining Formaldehyde Levels from Wood Products Under Defined Test Conditions Using a Large Chamber, ASTM E 1333-96, with the following exceptions:

(1) The chamber shall be operated indoors.

(2) Plywood and particleboard panels shall be individually tested in accordance with the following loading ratios:

- (i) Plywood—0.29 Ft²/Ft³, and
- (ii) Particleboard—0.13 Ft²/Ft³.

(3) Temperature to be maintained inside the chamber shall be 77° plus or minus 2 °F.

(4) The test concentration (C) shall be standardized to a level (C₀) at a temperature (t₀) of 77 °F and 50% relative humidity (H₀) by the following formula:

$$C = C_0 \times [1 + Ax (H - H_0)] \times e^{-R(t/t_0 - 1/t_0)}$$

where:

C = Test formaldehyde concentration

C₀ = Standardized formaldehyde concentration

e = Natural log base

R = Coefficient of temperature (9799)

t = Actual test condition temperature (° K)

t₀ = Standardized temperature (° K)

A = Coefficient of humidity (0.0175)

H = Actual relative humidity (%)

H₀ = Standardized relative humidity (%)

The standardized level (C₀) is the concentration used to determine compliance with § 3280.308(a).

(5) The air chamber shall be inspected and recalibrated at least annually to insure its proper operation under test conditions.

[49 FR 32012, Aug. 9, 1984, as amended at 58 FR 55009, Oct. 25, 1993; 70 FR 72046, Nov. 30, 2005]

Subpart F—Thermal Protection

§ 3280.501 Scope.

This subpart sets forth the requirements for condensation control, air infiltration, thermal insulation and certification for heating and comfort cooling.

§ 3280.502 Definitions.

(a) The following definitions are applicable to subpart F only:

(1) *Pressure envelope* means that primary air barrier surrounding the living space which serves to limit air leakage. In construction using ventilated cavities, the pressure envelope is the interior skin.

(2) *Thermal envelope area* means the sum of the surface areas of outside walls, ceiling and floor, including all openings. The wall area is measured by multiplying outside wall lengths by the inside wall height from floor to ceiling.

§ 3280.503

24 CFR Ch. XX (4-1-11 Edition)

The floor and ceiling areas are considered as horizontal surfaces using exterior width and length.

§ 3280.503 Materials.

Materials used for insulation shall be of proven effectiveness and adequate durability to assure that required design conditions concerning thermal transmission are attained.

§ 3280.504 Condensation control and installation of vapor retarders.

(a) *Ceiling vapor retarders.* (1) In Uo Value Zones 2 and 3, ceilings must have a vapor retarder with a permeance of not greater than 1 perm (as measured by ASTM E 96-95 Standard Test Methods for Water Vapor Transmission of Materials) installed on the living space side of the roof cavity.

(2) For manufactured homes designed for Uo Value Zone 1, the vapor retarder may be omitted.

(b) *Exterior walls.* (1) Exterior walls must have a vapor retarder with a permeance no greater than 1 perm (dry cup method) installed on the living space side of the wall; or

(2) Unventilated wall cavities must have an external covering and/or sheathing that forms the pressure envelope. The covering and/or sheathing must have a combined permeance of not less than 5.0 perms. In the absence of test data, combined permeance is permitted to be computed using the following formula: $P_{total} = (1/[(1/P_1) + (1/P_2)])$, where P_1 and P_2 are the

permeance values of the exterior covering and sheathing in perms. Formed exterior siding applied in sections with joints not caulked or sealed, are not considered to restrict water vapor transmission; or

(3) Wall cavities must be constructed so that ventilation is provided to dissipate any condensation occurring in these cavities; or

(4) Homes manufactured to be sited in "humid climates" or "fringe climates" as shown on the Humid and Fringe Climate Map in this paragraph are permitted to have a vapor retarder specified in paragraph (b)(1) of this section installed on the exterior side of the wall insulation or be constructed with an external covering and sheathing with a combined permeance of not greater than 1.0 perms, provided the interior finish and interior wall panel materials have a combined permeance of not less than 5.0 perms. The following need not meet the minimum combined permeance rating of not less than 5.0 perms for interior finish or wall panel materials:

(i) Kitchen back splash materials, less than 50 square feet in area installed around countertops, sinks, and ranges;

(ii) Bathroom tub areas, shower compartments;

(iii) Cabinetry and built-in furniture;

(iv) Trim materials;

(v) Hardboard wall paneling of less than 50 square feet in area under chair rails.

Humid and Fringe Climate Map

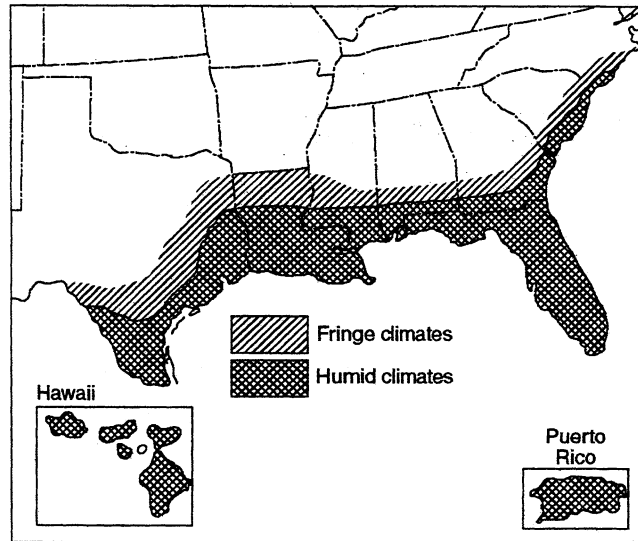

(5) The following areas of local governments (counties or similar areas, unless otherwise specified), listed by state are deemed to be within the humid and fringe climate areas shown on the Humid and Fringe Climate Map in paragraph (b)(4) of this section, and the vapor retarder or construction methods specified in paragraph (b)(4) of this section may be applied to homes built to be sited within these jurisdictions:

ALABAMA

Baldwin, Barbour, Bullock, Butler, Choctaw, Clarke, Coffee, Conecuh, Covington, Crenshaw, Dale, Escambia, Geneva, Henry, Houston, Lowndes, Marengo, Mobile, Monroe, Montgomery, Pike, Washington, Wilcox.

FLORIDA

All counties and locations within the State of Florida.

GEORGIA

Appling, Atkinson, Bacon, Baker, Ben Hill, Berrien, Brantley, Brooks, Bryan, Calhoun, Camden, Charlton, Chatham, Clay, Clinch, Coffee, Colquitt, Cook, Crisp, Decatur, Dougherty, Early, Echols, Effingham, Evans, Glynn, Wayne, Grady, Irwin, Jeff Davis, Lanier, Lee, Liberty, Long, Lowndes, McIntosh, Miller, Mitchell, Pierce, Quitman, Randolph,

Seminole, Tattnall, Terrell, Thomas, Tift, Turner, Ware, Worth.

HAWAII

All counties and locations within the State of Hawaii.

LOUISIANA

All counties and locations within the State of Louisiana.

MISSISSIPPI

Adams, Amite, Claiborne, Clarke, Copiah, Covington, Forrest, Franklin, George, Greene, Hancock, Harrison, Hinds, Issaquena, Jackson, Jasper, Jefferson, Jefferson Davis, Jones, Lamar, Lawrence, Lincoln, Marion, Pearl River, Perry, Pike, Rankin, Simpson, Smith, Stone, Walthall, Warren, Wayne, Wilkinson.

NORTH CAROLINA

Brunswick, Carteret, Columbus, New Hanover, Onslow, Pender.

SOUTH CAROLINA

Jasper, Beaufort, Colleton, Dorchester, Charleston, Berkeley, Georgetown, Horry.

TEXAS

Anderson, Angelina, Aransas, Atascosa, Austin, Bastrop, Bee, Bexar, Brazoria, Brazos, Brooks, Burleson, Caldwell, Calhoun,

§ 3280.505

Cameron, Camp, Cass, Chambers, Cherokee, Colorado, Comal, De Witt, Dimmit, Duval, Falls, Fayette, Fort Bend, Franklin, Freestone, Frio, Galveston, Goliad, Gonzales, Gregg, Grimes, Guadalupe, Hardin, Harris, Harrison, Hays, Henderson, Hidalgo, Hopkins, Houston, Jackson, Jasper, Jefferson, Jim Hogg, Jim Wells, Karnes, Kaufman, Kennedy, Kinney, Kleberg, La Salle, Lavaca, Lee, Leon, Liberty, Limestone, Live Oak, Madison, Marion, Matagorda, Maverick, McMullen, Medina, Milam, Montgomery, Morris, Nacogdoches, Navarro, Newton, Nueces, Orange, Panola, Polk, Rains, Refugio, Robertson, Rusk, Sabine, San Augustine, San Jacinto, San Patricio, Shelby, Smith, Starr, Titus, Travis, Trinity, Tyler, Upshur, Uvalde, Val Verde, Van Zandt, Victoria, Walker, Waller, Washington, Webb, Wharton, Willacy, Williamson, Wilson, Wood, Zapata, Zavala.

(c) *Attic or roof ventilation.* (1) Attic and roof cavities shall be vented in accordance with one of the following:

(i) A minimum free ventilation area of not less than 1/300 of the attic or roof cavity floor area. At least 50 percent of the required free ventilation area shall be provided by ventilators located in the upper portion of the space to be ventilated. At least 40 percent shall be provided by eave, soffit or low gable vents. The location and spacing of the vent openings and ventilators shall provide cross-ventilation to the entire attic or roof cavity space. A clear air passage space having a minimum height of 1 inch shall be provided between the top of the insulation and the roof sheathing or roof covering. Baffles or other means shall be provided where needed to insure the 1 inch height of the clear air passage space is maintained.

(ii) A mechanical attic or roof ventilation system may be installed instead of providing the free ventilation area when the mechanical system provides a minimum air change rate of 0.02 cubic feet per minute (cfm) per sq. ft. of attic floor area. Intake and exhaust vents shall be located so as to provide air movement throughout space.

(2) Single section manufactured homes constructed with metal roofs and having no sheathing or underlayment installed, are not required to be provided with attic or roof cavity ventilation provided that the air leakage paths from the living space to the roof cavity created by electrical

24 CFR Ch. XX (4-1-11 Edition)

outlets, electrical junctions, electrical cable penetrations, plumbing penetrations, flue pipe penetrations and exhaust vent penetrations are sealed.

(3) Parallel membrane roof section of a closed cell type construction are not required to be ventilated.

(4) The vents provided for ventilating attics and roof cavities shall be designed to resist entry of rain and insects.

[40 FR 58752, Dec. 18, 1975. Redesignated at 44 FR 20679, Apr. 6, 1979, as amended at 58 FR 55009, Oct. 25, 1993; 70 FR 72046, Nov. 30, 2005; 71 FR 19639, Apr. 17, 2006]

§ 3280.505 Air infiltration.

(a) *Envelope air infiltration.* The opaque envelope shall be designed and constructed to limit air infiltration to the living area of the home. Any design, material, method or combination thereof which accomplishes this goal may be used. The goal of the infiltration control criteria is to reduce heat loss/heat gain due to infiltration as much as possible without impinging on health and comfort and within the limits of reasonable economics.

(1) *Envelope penetrations.* Plumbing, mechanical and electrical penetrations of the pressure envelope not exempted by this part, and installations of window and door frames shall be constructed or treated to limit air infiltration. Penetrations of the pressure envelope made by electrical equipment, other than distribution panel boards and cable and conduit penetrations, are exempt from this requirement. Cable penetrations through outlet boxes are considered exempt.

(2) *Joints between major envelope elements.* Joints not designed to limit air infiltration between wall-to-wall, wall-to-ceiling and wall-to-floor connections shall be caulked or otherwise sealed. When walls are constructed to form a pressure envelope on the outside of the wall cavity, they are deemed to meet this requirement.

§ 3280.506 Heat loss/heat gain.

The manufactured home heat loss/heat gain shall be determined by methods outlined in §§ 3280.508 and 3280.509. The U_o (Coefficient of heat transmission) value zone for which the manufactured home is acceptable and the

lowest outdoor temperature to which the installed heating equipment will maintain a temperature of 70 F shall be

certified as specified in § 3280.510 of this subpart. The Uo value zone shall be determined from the map in figure 506.

U/O Value Zone Map for Manufactured Housing

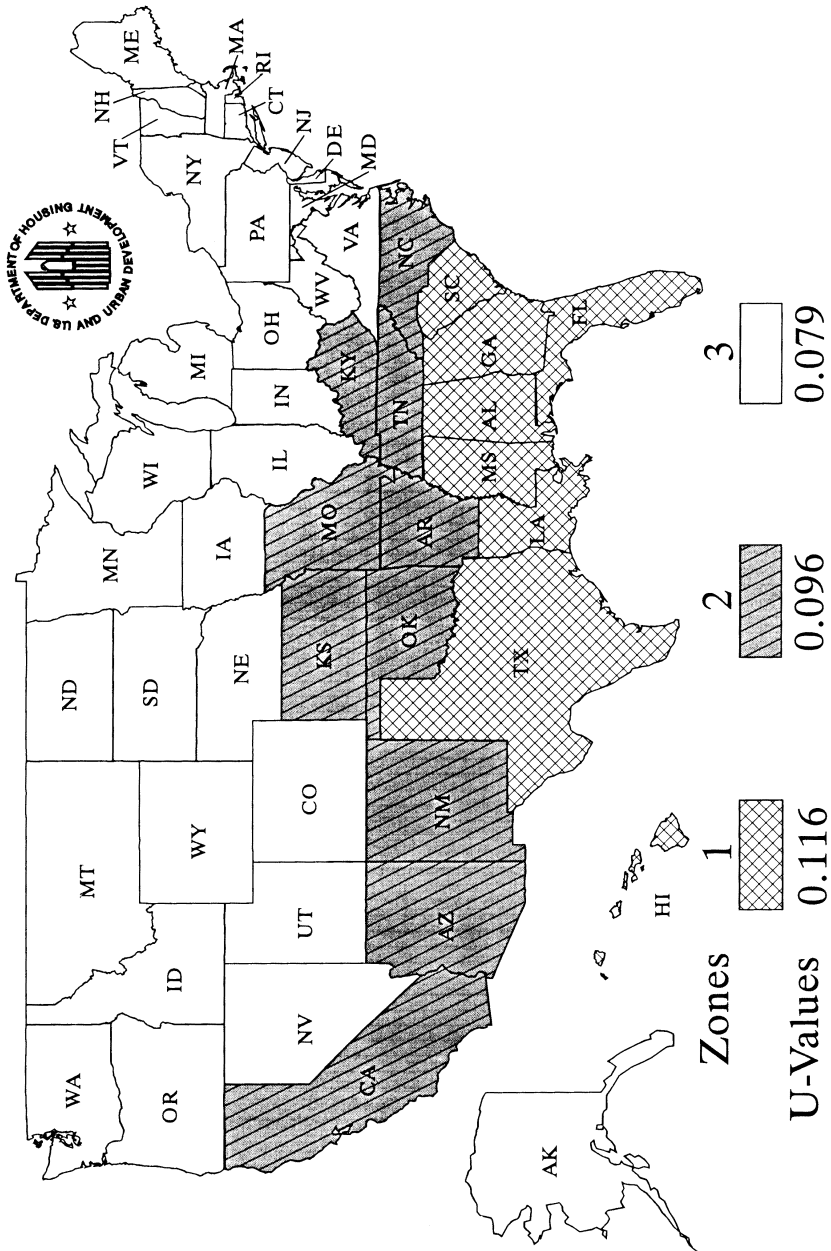

§ 3280.507

24 CFR Ch. XX (4-1-11 Edition)

(a) *Coefficient of heat transmission.* The overall coefficient of heat transmission (U_o) of the manufactured home for the respective zones and an indoor design temperature of 70 F, including internal and external ducts, and excluding infiltration, ventilation and condensation control, shall not exceed the Btu/(hr.) (sq. ft.) (F) of the manufactured home envelope are as tabulated below:

U _o value zone	Maximum coefficient of heat transmission
1	0.116 Btu/(hr.) (sq. ft.) (F).
2	0.096 Btu/(hr.) (sq. ft.) (F).
3	0.079 Btu/(hr.) (sq. ft.) (F).

(b) To assure uniform heat transmission in manufactured homes, cavities in exterior walls, floors, and ceilings shall be provided with thermal insulation.

(c) Manufactured homes designed for U_o Value Zone 3 shall be factory equipped with storm windows or insulating glass.

[58 FR 55009, Oct. 25, 1993; 59 FR 15113, Mar. 31, 1994]

§ 3280.507 Comfort heat gain.

Information necessary to calculate the home cooling load shall be provided as specified in this part.

(a) *Transmission heat gains.* Homes complying with this section shall meet the minimum heat loss transmission coefficients specified in §3280.506(a).

§ 3280.508 Heat loss, heat gain and cooling load calculations.

(a) Information, values and data necessary for heat loss and heat gain determinations must be taken from the 1997 ASHRAE Handbook of Fundamentals, Inch-Pound Edition, chapters 22 through 27. The following portions of those chapters are not applicable:

- 23.1 Steel Frame Construction
- 23.2 Masonry Construction
- 23.3 Foundations and Floor Systems
- 23.15 Pipes
- 23.17 Tanks, Vessels, and Equipment
- 23.18 Refrigerated Rooms and Buildings
- 24.18 Mechanical and Industrial Systems
- 25.19 Commercial Building Envelope Leakage
- 27.9 Calculation of Heat Loss from Crawl Spaces

(b) The calculation of the manufactured home's transmission heat loss coefficient (U_o) must be in accordance with the fundamental principles of the 1997 ASHRAE Handbook of Fundamentals, Inch-Pound Edition, and, at a minimum, must address all the heat loss or heat gain considerations in a manner consistent with the calculation procedures provided in the document, Overall U-values and Heating/Cooling Loads—Manufactured Homes—February 1992—PNL 8006, HUD User No. 0005945.

(c) Areas where the insulation does not fully cover a surface or is compressed shall be accounted for in the U-calculation (see §3280.506). The effect of framing on the U-value must be included in the U_o calculation. Other low-R-value heat-flow paths (“thermal shorts”) shall be explicitly accounted for in the calculation of the transmission heat loss coefficient if in the aggregate all types of low-R-value paths amount to more than 1% of the total exterior surface area. Areas are considered low-R-value heat-flow paths if:

- (1) They separate conditioned and unconditioned space; and
- (2) They are not insulated to a level that is at least one-half the nominal insulation level of the surrounding building component.

(d) *High efficiency heating and cooling equipment credit.* The calculated transmission heat loss coefficient (U_o) used for meeting the requirement in §3280.506(a) may be adjusted for heating and cooling equipment above that required by the National Appliance Energy Conservation Act of 1987 (NAECA) by applying the following formula:

$$U_o \text{ adjusted} = U_o \text{ standard} \times [1 + (0.6) (\text{heating efficiency increase factor}) + (\text{cooling multiplier}) (\text{cooling efficiency increase factor})]$$

where:

U_o standard = Maximum U_o for U_o Zone required by §3280.506(a)

U_o adjusted = Maximum U_o standard adjusted for high efficiency HVAC equipment
 Heating efficiency increase factor = The increase factor in heating equipment efficiency measured by the Annual Fuel Utilization Efficiency (AFUE), or the Heating Seasonal Performance Factor (HSPF) for heat pumps, above that required by

NAECA (indicated as "NAECA" in formula). The formula is heating efficiency increase factor = AFUE (HSPF) home - AFUE (or HSPF) NAECA divided by AFUE (HSPF) NAECA.

Cooling efficiency increase factor = the increase factor in the cooling equipment efficiency measured by the Seasonal Energy Efficiency Ratio (SEER) above that required by NAECA.

The formula being cooling equipment=SEER home-SEER NAECA divided by SEER NAECA.

The cooling multiplier for the Uo Zone is from the following table:

Uo zone	Cooling multiplier (Cm)
1	0.60 (Florida only).
1	0.20 (All other locations).
2	0.07.
3	0.03.

(e) U values for any glazing (e.g., windows, skylights, and the glazed portions of any door) must be based on tests using AAMA 1503.1-1988, Voluntary Test Method for Thermal Transmittance and Condensation Resistance of Windows, Doors, and Glazed Wall Sections, or the National Fenestration Rating Council 100, 1997 Edition, Procedure for Determining Fenestration Product U-factors. In the absence of tests, manufacturers are to use the residential window U values contained in Chapter 29, Table 5 of the 1997 ASHRAE Handbook of Fundamentals, Inch-Pound Edition. In the event that the classification of the window type is indeterminate, the manufacturer must use the classification that gives the higher U value. Where a composite of materials from two different product types is used, the product is to be assigned the higher U value. For the purpose of calculating U_o values, storm windows are treated as an additional pane.

(f) *Annual energy used based compliance.* As an alternative, homes may demonstrate compliance with the annual energy used implicit in the coeffi-

cient of heat transmission (U_o) requirement. The annual energy use determination must be based on generally accepted engineering practices. The general requirement is to demonstrate that the home seeking compliance approval has a projected annual energy use, including both heating and cooling, less than or equal to a similar "base case" home that meets the standard. The energy use for both homes must be calculated based on the same assumptions; including assuming the same dimensions for all boundaries between conditioned and unconditioned spaces, site characteristics, usage patterns and climate.

[58 FR 55011, Oct. 25, 1993, as amended at 70 FR 72047, Nov. 30, 2005]

§ 3280.509 Criteria in absence of specific data.

In the absence of specific data, for purposes of heat-loss/gain calculation, the following criteria shall be used:

(a) *Infiltration heat loss.* In the absence of measured infiltration heat loss data, the following formula shall be used to calculate heat loss due to infiltration and intermittently operated fans exhausting to the outdoors. The perimeter calculation shall be based on the dimensions of the pressure envelope.

Infiltration Heat-Loss=0.7 (T) (ft. of perimeter), BTU/hr.

where: T=70 minus the heating system capacity certification temperature stipulated in the Heating Certificate, in F.

(b) *Framing areas.*

- Wall 15 percent of wall area less windows and doors.
- Floor and Ceiling 10 percent of the area.

(c) *Insulation compression.* Insulation compressed to less than nominal thickness shall have its nominal R-values reduced for that area which is compressed in accordance with the following graph:

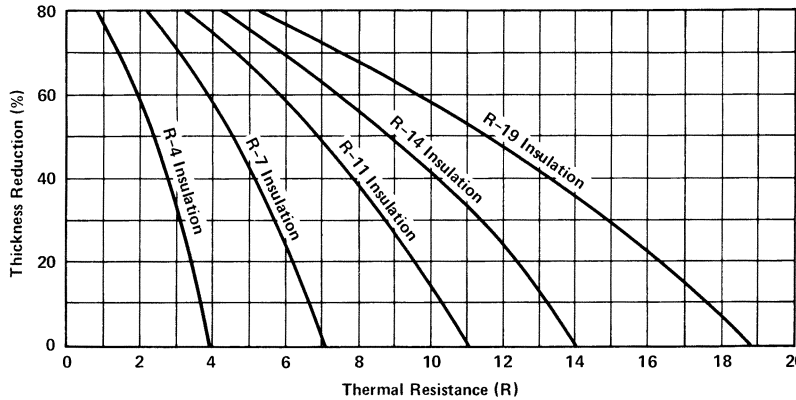

When insulation is installed over the framing members the thermal performance of the insulation is reduced due to compression at the framing members. The Resistance value of the insulation between the framing members is reduced by 12.5 percent for framing members 16" O.C., 8.5 percent for framing members 24" O.C., and 4 percent for framing members 48" O.C.

(d) *Air supply ducts within floor cavity.* Air supply ducts located within a floor cavity shall be assumed to be heating or cooling the floor cavity to living space temperatures unless the duct is structurally isolated by the framing system or thermally insulated from the rest of the floor cavity with a thermal insulation at least equal to R-4.

(e) *Air supply ducts within ceiling cavity.* Where supply ducts are located in ceiling cavities, the influence of the duct on cavity temperatures shall be considered in calculating envelope heat loss or heat gain.

(f) The supply duct loss (and/or heat gain where applicable—See § 3280.511) shall be calculated using the actual duct surface area and the actual thickness of insulation between the duct and outside of the manufactured home. If there is an air space of at least 1/2 inch between the duct and the insulation, heat loss/gain need not be calculated if the cavity in which the duct is located is assumed to be at living space temperature. The average temperature inside the supply duct, including ducts installed outside the manufactured home, shall be assumed to be 130 F for

purposes of calculation of heat loss and 60 F for heat gain.

(g) *Return air cavities.* Cavities used as return air plenums shall be considered to be at living space temperature.

§ 3280.510 Heat loss certificate.

The manufactured home manufacturer shall permanently affix the following "Certificate" to an interior surface of the home that is readily visible to the homeowner. The "Certificate" shall specify the following:

(a) *Heating zone certification.* The design zone at which the manufactured home heat loss complies with § 3280.506(a).

(b) *Outdoor certification temperature.* The lowest outdoor temperature at which the installed heating equipment will maintain a 70°F temperature inside the home without storm sash or insulating glass for Zones 1 and 2, and with storm sash or insulating glass for Zone 3 and complying with § 3280.508 and § 3280.509.

(c) *Operating economy certification temperature.* The temperature to be specified for operating economy and energy conservation shall be 20°F or 30% of the design temperature difference, whichever is greater, added to the temperature specified as the heating system capacity certification temperature without storm windows or insulating glass in Zones 1 and 2 and with storm windows or insulating glass in Zone 3. Design temperature difference is 70°

minus the heating system capacity certification temperature in degrees Fahrenheit.

HEATING CERTIFICATE

Home Manufacturer _____
Plant Location _____
Home Model _____

(Include Uo Value Zone Map)

This manufactured home has been thermally insulated to conform with the requirements of the Federal Manufactured Home Construction and Safety Standards for all locations within Uo Value Zone ____.

Heating Equipment Manufacturer _____
Heating Equipment Model _____

The above heating equipment has the capacity to maintain an average 70°F temperature in this home at outdoor temperatures of [see paragraph (b) of this section] F. To maximize furnace operating economy and to conserve energy, it is recommended that this home be installed where the outdoor winter design temperature (97 1/2%) is not higher than [see paragraph (c) of this section] F degrees Fahrenheit.

The above information has been calculated assuming a maximum wind velocity of 15 MPH at standard atmospheric pressure.

(d) The following additional statement must be provided on the heating certificate and data plate required by § 3280.5 when the home is built with a vapor retarder of not greater than one perm (dry cup method) on the exterior side of the insulation: "This home is designed and constructed to be sited only in humid or fringe climate regions as shown on the Humid and Fringe Climate Map." A reproduction of the Humid and Fringe Climate Map in § 3280.504 is to be provided on the heating certificate and data plate. The map must be not less than 3½ inch × 2¼ inch in size and may be combined with the U_o Value Zone Map for Manufactured Housing in § 3280.506.

[40 FR 58752, Dec. 18, 1975. Redesignated at 44 FR 20679, Apr. 6, 1979, as amended at 58 FR 55011, Oct. 25, 1993; 70 FR 72048, Nov. 30, 2005]

§ 3280.511 Comfort cooling certificate and information.

(a) The manufactured home manufacturer shall permanently affix a "Comfort Cooling Certificate" to an interior surface of the home that is readily visible to the home owner. This certificate may be combined with the heating certificate required in § 3280.510. The man-

ufacturer shall comply with one of the following three alternatives in providing the certificate and additional information concerning the cooling of the manufactured home:

(1) *Alternative 1.* If a central air conditioning system is provided by the home manufacturer, the heat gain calculation necessary to properly size the air conditioning equipment shall be in accordance with procedures outlined in chapter 22 of the 1989 ASHRAE Handbook of Fundamentals, with an assumed location and orientation. The following shall be supplied in the Comfort Cooling Certificate:

Air Conditioner Manufacturer _____
Air Conditioner Model _____

Certified Capacity ____ BTU/Hr. in accordance with the appropriate Air Conditioning and Refrigeration Institute Standards

The central air conditioning system provided with this home has been sized, assuming an orientation of the front (hitch) end of the home facing ____ and is designed on the basis of a 75 °F indoor temperature and an outdoor temperature of ____ °F dry bulb and ____ °F wet bulb.

EXAMPLE ALTERNATE I

COMFORT COOLING CERTIFICATE

Manufactured Home Mfg _____
Plant Location _____
Manufactured Home Model _____
Air Conditioner Manufacturer _____

Certified Capacity ____ BTU/Hr. in accordance with the appropriate Air Conditioning and Refrigeration Institute Standards.

The central air conditioning system provided with this home has been sized assuming an orientation of the front (hitch end) of the home facing _____. On this basis, the system is designed to maintain an indoor temperature of 75 °F when outdoor temperatures are ____ °F dry bulb and ____ °F wet bulb.

The temperature to which this home can be cooled will change depending upon the amount of exposure of the windows to the sun's radiant heat. Therefore, the home's heat gains will vary dependent upon its orientation to the sun and any permanent shading provided. Information concerning the calculation of cooling loads at various locations, window exposures and shadings are provided in chapter 22 of the 1989 edition of the ASHRAE Handbook of Fundamentals.

(2) *Alternative 2.* For each home suitable for a central air cooling system,

§ 3280.601

24 CFR Ch. XX (4-1-11 Edition)

the manufacturer shall provide the following statement: "This air distribution system of this home is suitable for the installation of a central air conditioning system."

EXAMPLE ALTERNATE 2

COMFORT COOLING CERTIFICATE

Manufactured Home Manufacturer _____
 Plant Location _____
 Manufactured Home Model _____

This air distribution system of this home is suitable for the installation of central air conditioning.

The supply air distribution system installed in this home is sized for Manufactured Home Central Air Conditioning System of up to _____ B.T.U./Hr. rated capacity which are certified in accordance with the appropriate Air Conditioning and Refrigeration Institute Standards. When the air circulators of such air conditioners are rated at 0.3 inch water column static pressure or greater for the cooling air delivered to the manufactured home supply air duct system.

Information necessary to calculate cooling loads at various locations and orientations is provided in the special comfort cooling information provided with this manufactured home.

(3) *Alternative 3.* If the manufactured home is not equipped with an air supply duct system, or if the manufacturer elects not to designate the home as being suitable for the installation of a central air conditioning system, the manufacturer shall provide the following statement: "This air distribution system of this home has not been designed in anticipation of its use with a central air conditioning system."

EXAMPLE ALTERNATE 3

COMFORT COOLING CERTIFICATE

Manufactured Home Mfg _____
 Plant Location _____
 Manufactured Home Model _____

The air distribution system of this home has not been designed in anticipation of its use with a central air conditioning system.

(b) For each home designated as suitable for central air conditioning the manufacturer shall provide the maximum central manufactured home air conditioning capacity certified in accordance with the ARI Standard 210/240-89 Unitary Air-Conditioning and Air-Source Heat Pump Equipment and in accordance with § 3280.715(a)(3). If the capacity information provided is

based on entrances to the air supply duct at other than the furnace plenum, the manufacturer shall indicate the correct supply air entrance and return air exit locations.

(c) *Comfort cooling information.* For each manufactured home designated, either "suitable for" or "provided with" a central air conditioning system, the manufacturer shall provide comfort cooling information specific to the manufactured home necessary to complete the cooling load calculations. The comfort cooling information shall include a statement to read as follows:

To determine the required capacity of equipment to cool a home efficiently and economically, a cooling load (heat gain) calculation is required. The cooling load is dependent on the orientation, location and the structure of the home. Central air conditioners operate most efficiently and provide the greatest comfort when their capacity closely approximates the calculated cooling load. Each home's air conditioner should be sized in accordance with chapter 22 of the American Society of Heating, Refrigerating and Air Conditioning Engineers (ASHRAE) Handbook of Fundamentals, 1989 Edition, once the location and orientation are known.

INFORMATION PROVIDED BY THE MANUFACTURER NECESSARY TO CALCULATE SENSIBLE HEAT GAIN

Walls (without windows and doors)	U
Ceilings and roofs of light color	U
Ceilings and roofs of dark color	U
Floors	U
Air ducts in floor	U
Air ducts in ceiling	U
Air ducts installed outside the home	U

Information necessary to calculate duct areas.

[40 FR 58752, Dec. 18, 1975. Redesignated at 44 FR 20679, Apr. 6, 1979, as amended at 58 FR 55012, Oct. 25, 1993]

Subpart G—Plumbing Systems

§ 3280.601 Scope.

Subpart G of this standard covers the plumbing materials, fixtures, and equipment installed within or on manufactured homes. It is the intent of this subpart to assure water supply, drain, waste and vent systems which permit satisfactory functioning and provide for health and safety under all conditions of normal use.

§ 3280.602 Definitions.

The following definitions are applicable to subpart G only:

Accessible, when applied to a fixture, connection, appliance or equipment, means having access thereto, but which may require removal of an access panel or opening of a door.

Air gap (water distribution system) means the unobstructed vertical distance through the free atmosphere between the lowest opening from any pipe or faucet supplying water to a tank, plumbing fixture, water supplied appliances, or other device and the flood level rim of the receptacle.

Anti-siphon trap vent device means a device which automatically opens to admit air to a fixture drain above the connection of the trap arm so as to prevent siphonage, and closes tightly when the pressure within the drainage system is equal to or greater than atmospheric pressure so as to prevent the escape of gases from the drainage system into the manufactured home.

Backflow means the flow of water or other liquids, mixtures, or substances into the distributing pipes of a potable supply of water from any source or sources other than its intended sources.

Backflow connection means any arrangement whereby backflow can occur.

Backflow preventer means a device or means to prevent backflow.

Branch means any part of the piping system other than a riser, main or stack.

Common vent means a vent connecting at the junction of fixture drains and serving as a vent for more than one fixture.

Continuous vent means a vertical vent that is a continuation of the drain to which it connects.

Continuous waste means a drain from two or more fixtures connected to a single trap.

Critical level means a point established by the testing laboratory (usually stamped on the device by the manufacturer) which determines the minimum elevation above the flood level rim of the fixture or receptacle served on which the device may be installed. When a backflow prevention device does not bear a critical level marking,

the bottom of the vacuum breaker, combination valve, or of any such approved or listed device shall constitute the critical level.

Cross connection means any physical connection or arrangement between two otherwise separate systems or sources, one of which contains potable water and the other either water, steam, gas or chemical of unknown or questionable safety whereby there may be a flow from one system or source to the other, the direction of flow depending on the pressure differential between the two systems.

Developed length means that length of pipe measured along the center line of the pipe and fittings.

Diameter, unless otherwise specifically stated, means the nominal (inside) diameter designated commercially.

Drain means a pipe that carries waste, water, or water-borne waste in a drainage system.

Drain connector means the removable extension, consisting of all pipes, fittings and appurtenances, from the drain outlet to the drain inlet serving the manufactured home.

Drain outlet means the lowest end of the main or secondary drain to which a sewer connection is made.

Drainage system means all piping within or attached to the structure that conveys sewage or other liquid waste to the drain outlet, not including the drain connector.

Fixture drain means the drain from the trap of a fixture to the junction of that drain with any other drain pipe.

Fixture supply means the water supply pipe connecting a fixture to a branch water supply pipe or directly to a main water supply pipe.

Flood-level means the level in the receptacle over which water would overflow to the outside of the receptacle.

Flooded means the condition which results when the liquid in a container or receptacle rises to the flood-level.

Flush tank means that portion of a water closet that is designed to contain sufficient water to adequately flush the fixture.

Flush valve means a device located at the bottom of a flush tank for flushing a water closet.

Flushometer tank: means a device integrated within an air accumulator vessel which is designed to discharge a predetermined quantity of water to fixtures for flushing purposes.

Flushometer valve means a device which discharges a predetermined quantity of water to a fixture for flushing purposes and is closed by direct water pressure.

Grade means the fall (slope) of a pipe in reference to a horizontal plane expressed in inches per foot length.

Horizontal branch means any pipe extending laterally, which receives the discharge from one or more fixture drains and connects to the main drain.

Horizontal pipe means any pipe or fitting which makes an angle of not more than 45 degrees with the horizontal.

Individual vent means a pipe installed to vent a fixture drain.

Inlet coupling means the terminal end of the water system to which the water service connection is attached. It may be a swivel fitting or threaded pipe end.

Main means the principal artery of the system to which branches may be connected.

Main drain means the lowest pipe of a drainage system which receives sewage from all the fixtures within a manufactured home and conducts these wastes to the drain outlet.

Main vent means the principal artery of the venting system to which vent branches may be connected.

Offset means a combination of pipe and/or fittings that brings one section of the pipe out of line but into a line parallel with the other section.

Pitch. See *Grade*.

Plumbing appliance: means any one of a special class of plumbing fixture which is intended to perform a special plumbing function. Its operation and/or control may be dependent upon one or more energized components, such as motors, control, heating elements, or pressure or temperature-sensing elements. Such fixture may operate automatically through one or more of the following actions: A time cycle, a temperature range, a pressure range, a measured volume or weight, or the fixture may be manually adjusted or controlled by the user or operator.

Plumbing appurtenance: means a manufactured device, or a prefabricated as-

sembly, or an on-the-job assembly of component parts, and which is an adjunct to the basic piping system and plumbing system and plumbing fixtures. An appurtenance demands no additional water supply, nor does it add any discharge load to a fixture or the drainage system.

Plumbing fixtures means receptacles, devices, or appliances which are supplied with water or which receive liquid or liquid-borne wastes for discharge into the drainage system.

Plumbing system means the water supply and distribution pipes; plumbing fixtures, faucets and traps; soil, waste and vent pipes; and water-treating or water-using equipment.

Primary vent. See *main vent*.

Relief vent means an auxiliary vent which permits additional circulation of air in or between drainage and vent systems.

Secondary vent means any vent other than the main vent or those serving each toilet.

Sewage means any liquid waste containing animal or vegetable matter in suspension or solution, and may include liquids containing chemicals in solution.

Siphonage means the loss of water seal from fixture traps resulting from partial vacuum in the drainage system which may be of either of the following two types, or a combination of the two:

(a) Self-siphonage resulting from vacuum in a fixture drain generated solely by the discharge of the fixture served by that drain, or,

(b) Induced siphonage resulting from vacuum in the drainage system generated by the discharge of one or more fixtures other than the one under observation.

Trap means a fitting or device designed and constructed to provide a liquid seal that will prevent the back passage of air without materially affecting the flow of liquid waste through it.

Trap arm means the portion of a fixture drain between a trap and its vent.

Trap seal means the vertical depth of liquid that a trap will retain.

Vacuum breaker. See *backflow preventer*.

Vent cap means the device or fitting which protects the vent pipe from foreign substance with an opening to the

atmosphere equal to the area of the vent it serves.

Vent system means that part of a piping installation which provides circulation of air within a drainage system.

Vertical pipe means any pipe or fitting which makes an angle of not more than 45 degrees with the vertical.

Water closet drain means that part of the drainage piping which receives the discharge from each individual water closet.

Water connection means the fitting or point of connection for the manufactured home water distribution system designed for connection to a water supply.

Water connector means the removable extension connecting the manufactured home water distribution system to the water supply.

Water distribution system means potable water piping within or permanently attached to the manufactured home.

Wet vent means a vent which also serves as a drain for one or more fixtures.

Wet vented drainage system means the specially designed system of drain piping that also vents one or more plumbing fixtures by means of a common waste and vent pipe.

Whirlpool bathtub means a plumbing appliance consisting of a bathtub fixture which is equipped and fitted with a circulation piping system, pump, and other appurtenances and is so designed to accept, circulate, and discharge bathtub water upon each use.

[40 FR 58752, Dec. 18, 1975. Redesignated at 44 FR 20679, Apr. 6, 1979, as amended at 52 FR 4584, Feb. 12, 1987; 52 FR 47553, Dec. 15, 1987; 58 FR 55012, Oct. 25, 1993]

§ 3280.603 General requirements.

(a) *Minimum requirements.* Any plumbing system installed in a manufactured home shall conform, at least, with the provisions of this subpart.

(1) *General.* The plumbing system shall be of durable material, free from defective workmanship, and so designed and constructed as to give satisfactory service for a reasonable life expectancy.

(2) *Conservation.* Water closets shall be selected and adjusted to use the minimum quantity of water consistent with proper performance and cleaning.

(3) *Connection to drainage system.* All plumbing, fixtures, drains, appurtenances, and appliances designed or used to receive or discharge liquid waste or sewage shall be connected to the manufactured home drainage system in a manner provided by this standard.

(4) *Workmanship.* All design, construction, and workmanship shall be in conformance with accepted engineering practices and shall be of such character as to secure the results sought to be obtained by this standard.

(5) *Components.* Plumbing materials, devices, fixtures, fittings, equipment, appliances, appurtenance, and accessories intended for use in or attached to a manufactured home shall conform to one of the applicable standards referenced in § 3280.604. Where an applicable standard is not referenced, or an alternative recognized standard is utilized, the plumbing component shall be listed by a nationally recognized testing laboratory, inspection agency or other qualified organization as suitable for the intended use.

(6) *Prohibited fittings and practices.* (i) Drainage or vent piping shall not be drilled and tapped for the purpose of making connections.

(ii) Except as specifically provided elsewhere in this standard, vent pipes shall not be used as waste or drain pipes.

(iii) Fittings, connections, devices, or methods of installation that obstruct or retard the flow of sewage, or air in the drainage or venting systems in an amount greater than the normal frictional resistance to flow shall not be used unless their use is acceptable in this standard or their use is accepted as having a desirable and acceptable function of ultimate benefit to the proper and continued functioning of the plumbing system.

(iv) Cracks, holes, or other imperfections in materials shall not be concealed by welding, brazing, or soldering or by paint, wax, tar, or other leak-sealing or repairing agents.

(v) Piping, fixtures or equipment shall be located so as not to interfere with the normal use or with the normal operation and use of windows, doors or other required facilities.

§ 3280.604

(vi) Galvanized pipe shall not be bent or welded.

(7) *Alignment of fittings.* All valves, pipes, and fittings shall be installed in correct relationship to the direction of flow.

(b) *Protective requirements.* (1) Cutting structural members. Structural members shall not be unnecessarily or carelessly weakened by cutting or notching.

(2) *Exposed piping.* All piping, pipe threads, hangers, and support exposed to the weather, water, mud, and road hazard, and subject to damage therefrom, shall be painted, coated, wrapped, or otherwise protected from deterioration.

(3) *Road damage.* Pipes, supports, drains, outlets, or drain hoses shall not extend or protrude in a manner where they could be unduly subjected to damage during transit.

(4) *Freezing.* All piping and fixtures subject to freezing temperatures shall be insulated or protected to prevent freezing, under normal occupancy. The manufacturer shall provide:

(i) Written installation instructions for the method(s) required for compliance to this section;

(ii) A statement in his installation instructions that if heat tape is used it shall be listed for use with manufactured homes;

(iii) A receptacle outlet for the use of a heat tape located on the underside of the manufactured home within 2 feet of the water supply inlet. The receptacle outlet provided shall not be placed on a branch circuit which is protected by a ground fault circuit interrupter.

(5) All piping, except the fixture trap, shall be designed to allow drainage.

(6) *Rodent resistance.* All exterior openings around piping and equipment shall be sealed to resist the entrance of rodents.

(7) Piping and electrical wiring shall not pass through the same holes in walls, floors or roofs. Plastic piping shall not be exposed to heat in excess of manufacturers recommendation or radiation from heat producing appliances.

[40 FR 58752, Dec. 18, 1975, as amended at 42 FR 54383, Oct. 5, 1977. Redesignated at 44 FR 20679, Apr. 6, 1979, as amended at 58 FR 55012, Oct. 25, 1993]

24 CFR Ch. XX (4-1-11 Edition)

§ 3280.604 Materials.

(a) *Minimum standards.* Materials, devices, fixtures, fittings, equipment, appliances, appurtenances and accessories shall conform to one of the standards in the following table and be free from defects. Where an appropriate standard is not indicated in the table or a standard not indicated in the table is preferred, the item may be used if it is listed. A listing is also required when so specified in other sections of this subpart.

(b) Where more than one standard is referenced for a particular material or component, compliance with only one of those standards is acceptable. Exceptions:

(1) When one of the reference standards requires evaluation of chemical, toxicity or odor properties which are not included in the other standard, then conformance to the applicable requirements of each standard shall be demonstrated;

(2) When a plastic material or component is not covered by the Standards in the following table, it must be certified as non-toxic in accordance with ANSI/NSF 61-2001, Drinking water system components—Health effects.

FERROUS PIPE AND FITTINGS

Gray Iron Threaded Fittings—ANSI/ASME B16.4-1992.

Malleable Iron Threaded Fittings—ANSI/ASME B16.3-1992.

Material and Property Standard for Special Cast Iron Fittings—IAPMO PS 5-84.

Welding and Seamless Wrought Steel Pipe—ANSI/ASME B36.10-1979.

Standard Specification for Pipe, Steel, Black and Hot-Dipped, Zinc-Coated, Welded and Seamless—ASTM A53-93.

Pipe Threads, General Purpose (Inch)—ANSI/ASME B1.20.1-1983.

Standard Specification for Cast Iron Soil Pipe and Fittings—ASTM A74-92.

Standard Specification for Hubless Cast Iron Soil Pipe and Fittings for Sanitary and Storm Drain, Waste, and Vent Piping Applications—CISPI-301-90.

NONFERROUS PIPE AND FITTINGS

Standard Specification for Seamless Copper Pipe, Standard Sizes—ASTM B42-93.

Standard Specification for General Requirements for Wrought Seamless Copper and Copper-Alloy Tube—ASTM B251-93.

Standard Specification for Seamless Copper Water Tube—ASTM B88-93.

Standard Specification for Copper Drainage Tube (DWV)—ASTM B306-92.
 Wrought Copper and Copper Alloy Solder-Joint Pressure Fitting—ASME/ANSI B16.22-1989.
 Wrought Copper and Wrought Copper Alloy Solder-Joint Drainage Fittings-DWV—ASME/ANSI B16.29-1986.
 Cast Copper Alloy Solder-Joint Pressure Fittings—ANSI B16.18-1984.
 Cast Copper Alloy Solder-Joint Drainage Fittings-DWV—ASME B16.23-1992.
 Cast Copper Alloy Fittings for Flared Copper Tubes—ASME/ANSI B16.26-1988.
 Standard Specification for Seamless Red Brass Pipe, Standard Sizes—ASTM B43-91.
 Cast Bronze Threaded Fittings, Classes 125 and 250—ANSI/ASME B16.15-1985.

PLASTIC PIPE AND FITTINGS

Standard Specification Acrylonitrile-Butadiene-Styrene (ABS) Schedule 40 Plastic Drain, Waste, and Vent Pipe and Fittings—ASTM D2661-91.
 Standard Specification for Poly (Vinyl Chloride) (PVC) Plastic Drain, Waste, and Vent Pipe and Fittings—ASTM D2665-91b.
 Standard Specification for Drain, Waste, and Vent (DWV) Plastic Fittings Patterns—ASTM D3311-92.
 Standard Specification for Acrylonitrile-Butadiene-Styrene (ABS) Schedule 40, Plastic Drain, Waste, and Vent Pipe With a Cellular Core—ASTM F628-91.
 Standard Specification for Chlorinated Poly (Vinyl Chloride) (CPVC) Plastic Hot- and Cold-Water Distribution Systems—ASTM D2846-92.
 Standard Specification for Polybutylene (PB) Plastic Hot- and Cold-Water Distribution Systems—ASTM D3309-92a.
 Plastic Piping Components and Related Materials—ANSI/NSF 14-1990.

MISCELLANEOUS

Standard Specification for Rubber Gaskets for Cast Iron Soil Pipe and Fittings—ASTM C564-88.
 Backflow Valves—ANSI A112.14.1-1975.
 Plumbing Fixture Setting Compound—TTP 1536A-1975.
 Material and Property Standard for Cast Brass and Tubing P-Traps—IAPMO PS 2-89.
 Relief Valves and Automatic Gas Shutoff Devices for Hot Water Supply Systems—ANSI Z21.22-1986, With Addendum Z21.22a-1990.
 Standard Specification for Solvent Cement for Acrylonitrile-Butadiene-Styrene (ABS) Plastic Pipe and Fittings—ASTM D2235-88.
 Standard Specification for Solvent Cements for Poly (Vinyl Chloride) (PVC) Plastic Piping Systems—ASTM D2564-91a.
 Specification for Neoprene Rubber Gaskets for HUB and Spigot Cast Iron Soil Pipe and Fittings—CISPI-HSN-85.

Plumbing System Components for Manufactured Homes and Recreational Vehicles—ANSI/NSF 24-1988.
 Material and Property Standard for Diversion Tees and Twin Waste Elbow—IAPMO PS 9-84.
 Material and Property Standard for Flexible Metallic Water Connectors—IAPMO PS 14-89.
 Material and Property Standard for Dishwasher Drain Airgaps—IAPMO PS 23-89.
 Material and Property Standards for Backflow Prevention Assemblies—IAPMO PS 31-91.
 Performance Requirements for Air Admittance Valves for Plumbing Drainage Systems, Fixture and Branch Devices—ASSE Standard #1051, 1990 Revised: 1996/ANSI 1998.
 Drinking Water System Components-Health Effects—ANSI/NSF 61-2001.

PLUMBING FIXTURES

Plumbing Fixtures (General Specifications)—FS WW-P-541E/GEN-1980.
 Vitreous China Plumbing Fixtures—ANSI/ASME A112.19.2(M)-1990.
 Enameled Cast Iron Plumbing Fixtures—ANSI/ASME A112.19.1M-1987.
 Porcelain Enameled Formed Steel Plumbing Fixtures—ANSI/ASME A112.19.4(M)-1984.
 Plastic Bathtub Units with Addenda Z124.1a-1990 and Z124.16-1991—ANSI Z124.1-1987.
 Standard for Porcelain Enameled Formed Steel Plumbing Fixtures—IAPMO TSC 22-85.
 Plastic Shower Receptors and Shower Stalls with Addendum Z124.2a-1990—ANSI Z124.2-1987.
 Stainless Steel Plumbing Fixtures (Designed for Residential Use)—ANSI/ASME A112.19.3M-1987.
 Material and Property Standard for Drains for Prefabricated and Precast Showers—IAPMO PS 4-90.
 Plastic Lavatories with Addendum Z124.3a-1990—ANSI Z124.3-1986.
 Safety Performance Specifications and Methods of Test for Safety Glazing Materials Used in Building—ANSI Z97.1-1984.
 Water Heater Relief Valve Drain Tubes—ASME A112.4.1-1993.
 Flexible Water Connectors—ASME A112.18.6-1999.
 Performance Requirements for Backflow Protection Devices and Systems in Plumbing Fixture Fittings—ASME A112.18.3M-1996.
 Non-Vitreous Ceramic Plumbing Fixtures—ASME A112.19.9M-1991.
 Dual Flush Devices for Water Closets—ASME A119.19.10-1994.
 Deck Mounted Bath/Shower Transfer Valves with Integral Backflow Protection—ASME A112.18.7-1999.

§ 3280.605

Plastic Fittings for Connecting Water Closets to the Sanitary Drainage System—ASME A112.4.3-1999.

Hydraulic Performance Requirements for Water Closets and Urinals, ASME A112.19.6-1995.

Plumbing Fixture Fittings—ASME/ANSI A112.18.1M-1989.

Trim for Water Closet, Bowls, Tanks, and Urinals—ANSI A112.19.5-1979.

Plastic Water Closets, Bowls, and Tanks with Addenda Z124.4a-1990—ANSI Z124.4-1986.

ANSI Z124.5, Plastic Toilet (Water Closets) Seats, 1997.

ANSI Z124.7, Prefabricated Plastic Spa Shells, 1997.

Whirlpool Bathtub Appliances—ASME/ANSI A112.19.7M-1987.

ANSI Z-124.9, Plastic Urinal Fixtures, 1994.

Performance Requirements for Individual Thermostatic Pressure Balancing and Combination Control for Bathing Facilities—ASSE 1016-1988 (ANSI 1990).

Performance Requirements for Pressurized Flushing Devices (Flushometers) for Plumbing Fixtures—ASSE 1037-1990 (ANSI-1990).

Performance Requirements for Water Closet Flush Tank Fill Valves (Ballcocks)—ASSE 1002 Revision 5-1986 (ANSI/ASSE-1979).

Performance Requirements for Hand-held Showers—ASSE 1014-1989 (ANSI-1990).

Hydrants for Utility and Maintenance Use—ANSI/ASME A112.21.3M-1985.

Performance Requirements for Home Laundry Equipment—ASSE 1007-1986.

Performance Requirements for Hot Water Dispensers, Household Storage Type Electrical—ASSE 1023, (ANSI/ASSE-1979).

Plumbing Requirements for Residential Use (Household) Dishwashers—ASSE 1006, (ASSE/ANSI-1986).

Performance Requirements for Household Food Waste Disposer Units—ASSE 1008-1986.

Performance Requirements for Temperature Activated Mixing Valves for Primary Domestic Use—ASSE 1017-1986.

Water Hammer Arresters—ANSI A112.26.1-1969 (R 1975).

Suction Fittings for Use in Swimming Pools, Wading Pools, Spas, Hot Tubs, and Whirlpool Bathtub Appliances—ASME/ANSI A112.19.8M-1989.

Air Gaps in Plumbing Systems—ASME A112.1.2-1991.

Performance Requirements for Diverters for Plumbing Faucets with Hose Spray, Anti-Siphon Type, Residential Applications—ASSE 1025 (ANSI/ASSE-1978).

Performance Requirements for Pipe Applied Atmospheric Type Vacuum Breakers—ASSE 1001 (ASSE/ANSI-1990).

Performance Requirements for Hose Connection Vacuum Breakers—ASSE 1011-1981 (ANSI-1982).

24 CFR Ch. XX (4-1-11 Edition)

Performance Requirements for Wall Hydrants, Frost Proof Automatic Draining, Anti-Backflow Types—ANSI/ASSE 1019-1978.

[58 FR 55013, Oct. 25, 1993, as amended at 70 FR 72048, Nov. 30, 2005]

§ 3280.605 Joints and connections.

(a) *Tightness.* Joints and connections in the plumbing system shall be gas-tight and watertight for the pressures required under testing procedures.

(1) *Assembling of pipe.* All joints and connections shall be correctly assembled for tightness. Pipe threads shall be fully engaged with the threads of the fitting. Plastic pipe and copper tubing shall be inserted to the full depth of the solder cup or welding sockets of each fitting. Pipe threads and slip joints shall not be wrapped with string, paper, putty, or similar fillers.

(2) *Threaded joints.* Threads for screw pipe and fittings shall conform to the approved or listed standard. Pipe ends shall be reamed out to size of bore. All burrs, chips, cutting oil and foreign matter shall be removed. Pipe joint cement or thread lubricant shall be of approved type and applied to male threads only.

(3) *Solder joints.* Solder joints for tubing shall be made with approved or listed solder type fittings. Surfaces to be soldered shall be cleaned bright. The joints shall be properly fluxed with noncorrosive paste type flux and, for manufactured homes to be connected to a public water system, made with solder having not more than 0.2 percent lead.

(4) *Plastic pipe, fittings and joints.* Plastic pipe and fittings shall be joined by installation methods recommended by the manufacturer or in accordance with the provisions of a recognized, approved, or listed standard.

(5) *Union joints.* Metal unions in water piping shall have metal-to-metal ground seats.

(6) *Flared joints.* Flared joints for soft-copper water tubing shall be made with approved or listed fittings. The tubing shall be expanded with a proper flaring tool.

(7) *Cast iron soil pipe joints.* Approved or listed cast iron pipe may be joined as follows:

(i) Approved or listed hubless pipe as per the manufacturer's recommendation.

(ii) Hub and plain-end soil pipe may be joined by compression fittings per the manufacturer's recommendation.

[40 FR 58752, Dec. 18, 1975. Redesignated at 44 FR 20679, Apr. 6, 1979, as amended at 53 FR 23611, June 23, 1988]

§ 3280.606 Traps and cleanouts.

(a) *Traps*—(1) *Traps required.* Each plumbing fixture, except listed toilets, shall be separately trapped by approved water seal "P" traps. All traps shall be effectively vented.

(2) *Dual fixtures.* A two-compartment sink, two single sinks, two lavatories, or a single sink and a single lavatory with waste outlets not more than 30 inches apart and in the same room and flood level rims at the same level may be connected to one "P" trap and may be considered as a single fixture for the purpose of drainage and vent requirements.

(3) *Prohibited traps.* A trap which depends for its seal upon concealed interior partitions shall not be used. Full "S" traps, bell traps, drum traps, crown-vented traps, and running traps are prohibited. Fixtures shall not be double-trapped.

(4) *Material and design.* Each trap shall be self-cleaning with a smooth and uniform interior waterway. Traps shall be manufactured of cast iron, cast brass, or drawn brass tubing of not less than No. 20 Brown and Sharpe gage, or approved or listed plastic, or other approved or listed material. Union joints for a trap shall be beaded to provide a shoulder for the union nut. Each trap shall have the manufacturer's name stamped or cast in the body of the trap, and each tubing trap shall show the gage of the tubing.

(5) *Trap seal.* Each "P" trap shall have a water seal of not less than 2 inches and not more than 4 inches and shall be set true to its seal.

(6) *Size.* Traps shall be not less than 1¼ inches in diameter. A trap shall not be larger than the waste pipe to which it is connected.

(7) *Location.* Each trap shall be located as close to its vent and to its fixture outlet as structural conditions will permit.

(8) *Length of tailpiece.* The vertical distance from a trap to the fixture outlet shall not exceed 24 inches.

(9) *Installation.* (i) *Grade of trap arm.* The piping between a "P" trap and the fixture tee or the vented waste line shall be graded ¼ inch per foot towards the vent and in no event shall have a slope greater than its diameter. The vent opening at fixture tees shall not be below the weir of the "P" trap outlet.

(ii) *Trap arm offset.* The piping between the "P" trap and vent may change direction or be offset horizontally with the equivalent of no more than 180 degrees total change in direction with a maximum of 90 degrees by any one fitting.

(iii) *Concealed traps.* Traps with mechanical joints shall be accessible for repair and inspection.

(iv) *Removability of traps, etc.* Traps shall be designed and installed so the "U" bend is removable without removing the strainers from the fixture. Continuous waste and tail pieces which are permanently attached to the "U" bend shall also be removable without removing the strainer from the fixture.

(b) *Cleanout openings*—(1) *Location of cleanout fittings.* (i) Cleanouts shall be installed if the drainage system cannot be cleaned through fixtures, drains, or vents. Cleanouts shall also be provided when fittings of more than 45 degrees are used to affect an offset except where long turn ells are used which provide sufficient "sweep" for cleaning.

(ii) A full size cleanout shall be installed at the upper end of any section of drain piping which does not have the required minimum slope of ¼ inch per foot grade.

(iii) A cleaning tool shall not be required to pass through more than 360 degrees of fittings, excluding removable "P" traps, to reach any part of the drainage system. Water closets may be removed for drainage system access.

(2) *Access to cleanouts.* Cleanouts shall be accessible through an unobstructed minimum clearance of 12 inches directly in front of the opening. Each cleanout fitting shall open in a direction opposite to the flow or at right angles to the pipe. Concealed cleanouts

§ 3280.607

24 CFR Ch. XX (4-1-11 Edition)

that are not provided with access covers shall be extended to a point above the floor or outside of the manufactured home, with pipe and fittings installed, as required, for drainage piping without sags and pockets.

(3) *Material.* Plugs and caps shall be brass or approved or listed plastic, with screw pipe threads.

(4) *Design.* Cleanout plugs shall have raised heads except that plugs at floor level shall have counter-sunk slots.

[40 FR 58752, Dec. 18, 1975. Redesignated at 44 FR 20679, Apr. 6, 1979, as amended at 58 FR 55014, Oct. 25, 1993]

§ 3280.607 Plumbing fixtures.

(a) *General requirements—(1) Quality of fixtures.* Plumbing fixtures shall have smooth impervious surfaces, be free from defects and concealed fouling surfaces, be capable of resisting road shock and vibration, and shall conform in quality and design to listed standards. Fixtures shall be permanently marked with the manufacturer's name or trademark.

(2) *Strainers.* The waste outlet of all plumbing fixtures, other than toilets, shall be equipped with a drain fitting that will provide an adequate unobstructed waterway.

(3) *Fixture connections.* Fixture tailpieces and continuous wastes in exposed or accessible locations shall be not less than No. 20 Brown and Sharpe gage seamless drawn-brass tubing or other approved pipe or tubing materials. Inaccessible fixture connections shall be constructed according to the requirements for drainage piping. Each fixture tailpiece, continuous waste, or waste and overflow shall be not less than 1½ inches for sinks of two or more compartments, dishwashers, clothes washing machines, laundry tubs, bath tubs, and not less than 1¼ inches for lavatories and single compartment sinks having a 2 inch maximum drain opening.

(4) *Concealed connections.* Concealed slip joint connections shall be provided with adequately sized unobstructed access panels and shall be accessible for inspection and repair.

(5) *Directional fitting.* An approved or listed "Y" or other directional-type branch fitting shall be installed in every tailpiece or continuous waste

that receives the discharge from food waste disposal units, dishwashing, or other force-discharge fixture or appliance. (See also §3280.607(b)(4)(ii).)

(6) *Water conservation.* All lavatory faucets, showerheads, and sink faucets must not exceed a flow of 2.5 gallons per minute (gpm).

(b) *Fixtures—(1) Spacing.* All plumbing fixtures shall be so installed with regard to spacing as to be reasonably accessible for their intended use.

(2) *Water closets.* (i) Water closets shall be designed and manufactured according to approved or listed standards and shall be equipped with a water flushing device capable of adequately flushing and cleaning the bowl at each operation of the flushing mechanism.

(ii) Water closet flushing devices shall be designed to replace the water seal in the bowl after each operation. Flush valves, flushometer valves, flushometer tanks and ballcocks shall operate automatically to shut off at the end of each flush or when the tank is filled to operating capacity.

(iii) All water closets must be low consumption (1.6 gallons per flush (gpf) closets).

(iv) Flush tanks shall be fitted with an overflow pipe large enough to prevent flooding at the maximum flow rate of the ball cock. Overflow pipes shall discharge into the toilet, through the tank.

(v) Water closets that have fouling surfaces that are not thoroughly washed at each discharge shall be prohibited. Any water closet that might permit the contents of the bowl to be siphoned back into the water system shall be prohibited.

(vi) *Floor connection.* Water closets shall be securely bolted to an approved flange or other approved fitting which is secured to the floor by means of corrosion-resistant screws. The bolts shall be of solid brass or other corrosion-resistant material and shall be not less than one-fourth inch in diameter. A watertight seal shall be made between the water closet and flange or other approved fitting by use of a gasket or sealing compound.

(3) *Shower compartment.* (i) Each compartment stall shall be provided with an approved watertight receptor with sides and back extending at least 1 inch

above the finished dam or threshold. In no case shall the depth of a shower receptor be less than 2 inches or more than 9 inches measured from the top of the finished dam or threshold to the top of the drain. The wall area shall be constructed of smooth, noncorrosive, and nonabsorbent waterproof materials to a height not less than 6 feet above the bathroom floor level. Such walls shall form a watertight joint with each other and with the bathtub, receptor or shower floor. The floor of the compartment shall slope uniformly to the drain at not less than one-fourth nor more than one-half inch per foot.

(ii) The joint around the drain connection shall be made watertight by a flange, clamping ring, or other approved listed means.

(iii) Shower doors and tub and shower enclosures shall be constructed so as to be waterproof and, if glazed, glazing shall comply with the standard for Safety Performance Specifications and Methods of Test for Safety Glazing Materials Used in Buildings, ANSI Z97.1-1984.

(iv) Prefabricated plumbing fixtures shall be approved or listed.

(4) *Dishwashing machines.* (i) A dishwashing machine shall not be directly connected to any waste piping, but shall discharge its waste through a fixed air gap installed above the machine, or through a high loop as specified by the dishwashing machine manufacturer, or into an open standpipe-receptor with a height greater than the washing compartment of the machine. When a standpipe is used, it shall be at least 18 inches but not more than 30 inches above the trap weir. The drain connections from the air gap or high loop may connect to an individual trap, to a directional fitting installed in the sink tailpiece or to an opening provided on the inlet side of a food waste disposal unit.

(ii) Drain from a dishwashing machine shall not be connected to a sink tailpiece, continuous waste line, or trap on the discharge side of a food waste disposal unit.

(5) *Clothes washing machines.* (i) Clothes washing machines shall drain either into a properly vented trap, into a laundry tub tailpiece with watertight connections, into an open standpipe re-

ceptor, or over the rim of a laundry tub.

(ii) Standpipes shall be 1½ inches minimum nominal iron pipe size, 1½ inches diameter nominal brass tubing not less than No. 20 Brown and Sharpe gage, or 1½ inches approved plastic materials. Receptors shall discharge into a vented trap or shall be connected to a laundry tub tailpiece by means of an approved or listed directional fitting. Each standpipe shall extend not less than 18 inches or more than 30 inches above its trap and shall terminate in an accessible location no lower than the top of clothes washing machine. A removable tight fitting cap or plug shall be installed on the standpipe when clothes washer is not provided.

(iii) Clothes washing machine drain shall not be connected to the tailpiece, continuous waste, or trap of any sink or dishwashing machine.

(c) *Installation*—(1) *Access.* Each plumbing fixture and standpipe receptor shall be located and installed in a manner to be accessible for usage, cleaning, repair and replacement. Access to diverter valves and other connections from the fixture hardware is not required.

(2) *Alignment.* Fixtures shall be set level and in true alignment with adjacent walls. Where practical, piping from fixtures shall extend to nearest wall.

(3) *Brackets.* Wall-hung fixtures shall be rigidly attached to walls by metal brackets or supports without any strain being transmitted to the piping connections. Flush tanks shall be securely fastened to toilets or to the wall with corrosive-resistant materials.

(4) *Tub supports.* Bathtub rims at wall shall be supported on metal hangers or on end-grain wood blocking attached to the wall unless otherwise recommended by the manufacturer of the tub.

(5) *Fixture fittings.* Faucets and diverters shall be installed so that the flow of hot water from the fittings corresponds to the left-hand side of the fitting.

(6) *Whirlpool bathtub appliances*—(i) *Access panel.* A door or panel of sufficient size shall be installed to provide access to the pump for repair and/or replacement.

§ 3280.608

24 CFR Ch. XX (4–1–11 Edition)

(ii) *Piping drainage.* The circulation pump shall be accessibly located above the crown weir of the trap. The pump drain line shall be properly sloped to drain the volute after fixture use.

(iii) *Piping.* Whirlpool bathtub circulation piping shall be installed to be self-draining.

(iv) *Electrical.* Wiring must comply with Articles 680.70, 680.71, and 680.72 of the National Electrical Code, NFPA No. 70–2005.

[40 FR 58752, Dec. 18, 1975, as amended at 42 FR 961, Jan. 4, 1977. Redesignated at 44 FR 20679, Apr. 6, 1979, as amended at 52 FR 4586, Feb. 12, 1987; 58 FR 55014, Oct. 25, 1993; 70 FR 72049, Nov. 30, 2005; 71 FR 19639, Apr. 17, 2006]

§ 3280.608 Hangers and supports.

(a) *Strains and stresses.* Piping in a plumbing system shall be installed without undue strains and stresses, and provision shall be made for expansion, contraction, and structural settlement.

(b) *Piping supports.* Piping shall be secured at sufficiently close intervals to keep the pipe in alignment and carry the weight of the pipe and contents. Unless otherwise stated in the standards for specific materials shown in the table in § 3280.604(a), or unless specified by the pipe manufacturer, plastic drainage piping shall be supported at intervals not to exceed 4 feet and plastic water piping shall be supported at intervals not to exceed 3 feet.

(c) *Hangers and anchors.* (1) Hangers and anchors shall be of sufficient strength to support their proportional share of the pipe alignments and prevent rattling.

(2) Piping shall be securely attached to the structure by hangers, clamps, or brackets which provide protection against motion, vibration, road shock, or torque in the chassis.

(3) Hangers and straps supporting plastic pipe shall not compress, distort, cut or abrade the piping and shall allow free movement of the pipe.

§ 3280.609 Water distribution systems.

(a) *Water supply—(1) Supply piping.* Piping systems shall be sized to provide an adequate quantity of water to each plumbing fixture at a flow rate sufficient to keep the fixture in a clean and sanitary condition without any danger of backflow or siphonage. (See

table in § 3280.609(f)(1)). The manufacturer shall include in his written installation instructions that the manufactured home has been designed for an inlet water pressure of 80 psi, and a statement that when the manufactured home is to be installed in areas where the water pressure exceeds 80 psi, a pressure reducing valve should be installed.

(2) *Hot water supply.* Each manufactured home equipped with a kitchen sink, and bathtub and/or shower shall be provided with a hot water supply system including a listed water heater.

(b) *Water outlets and supply connections—(1) Water connection.* Each manufactured home with a water distribution system shall be equipped with a ¾ inch threaded inlet connection. This connection shall be tagged or marked “Fresh Water Connection” (or marked “Fresh Water Fill”). A matching cap or plug shall be provided to seal the water inlet when it is not in use, and shall be permanently attached to the manufactured home or water supply piping. When a master cold water shutoff full flow valve is not installed on the main feeder line in an accessible location, the manufacturer’s installation instructions shall indicate that such a valve is to be installed in the water supply line adjacent to the home. When a manufactured home includes expandable rooms or is composed of two or more units, fittings or connectors designed for such purpose shall be provided to connect any water piping. When not connected, the water piping shall be protected by means of matching threaded caps or plugs.

(2) *Prohibited connections.* (i) The installation of potable water supply piping or fixture or appliance connections shall be made in a manner to preclude the possibility of backflow.

(ii) No part of the water system shall be connected to any drainage or vent piping.

(3) *Rim outlets.* The outlets of faucets, spouts, and similar devices shall be spaced at least 1 inch above the flood level of the fixture.

(4) *Appliance connections.* Water supplies connected to clothes washing or dishwashing machines shall be protected by an approved or listed fixed

air gap provided within the appliance by the manufacturer.

(5) *Flushometer valves or manually operated flush valves.* An approved or listed vacuum breaker shall be installed and maintained in the water supply line on the discharge side of a water closet flushometer valve or manually operated flush valve. Vacuum breakers shall have a minimum clearance of 6 inches above the flood level of the fixture to the critical level mark unless otherwise permitted in their approval.

(6) *Flush tanks.* Water closet flush tanks shall be equipped with an approved or listed anti-siphon ball cock which shall be installed and maintained with its outlet or critical level mark not less than 1 inch above the full opening of the overflow pipe.

(7) *Hose bibbs.* When provided, all exterior hose bibbs and laundry sink hose connections shall be protected by a listed non-removable backflow prevention device. This is not applicable to hose connections provided for automatic washing machines with built-in backflow prevention.

(8) *Flushometer tanks.* Flushometer tanks shall be equipped with an approved air gap on the vacuum breaker assembly located above the flood level rim above the fixture.

(c) *Water heater safety devices—(1) Relief valves.* (i) All water heaters shall be installed with approved and listed fully automatic valve or valves designed to provide temperature and pressure relief.

(ii) Any temperature relief valve or combined pressure and temperature relief valve installed for this purpose shall have the temperature sensing element immersed in the hottest water within the upper 6 inches of the tank. It shall be set to start relieving at a pressure of 150 psi or the rated working pressure of the tank whichever is lower and at or below a water temperature of 210 °F.

(iii) Relief valves shall be provided with full-sized drains, with cross sectional areas equivalent to that of the relief valve outlet, which shall be directed downward and discharge beneath the manufactured home. Drain lines shall be of a material listed for hot water distribution and shall drain fully by gravity, shall not be trapped,

and shall not have their outlets threaded, and the end of the drain shall be visible for inspection.

(d) *Materials—(1) Piping material.* Water pipe shall be of standard weight brass, galvanized wrought iron, galvanized steel, Type K, L or M copper tubing, approved or listed plastic or other approved or listed material.

(i) *Plastic piping.* All plastic water piping and fittings in manufactured homes must be listed for use with hot water.

(ii) [Reserved]

(2) *Fittings.* Appropriate fittings shall be used for all changes in size and where pipes are joined. The material and design of fittings shall conform to the type of piping used. Special consideration shall be given to prevent corrosion when dissimilar metals are joined.

(i) Fittings for screw piping shall be standard weight galvanized iron for galvanized iron and steel pipe, and of brass for brass piping. They shall be installed where required for change in direction, reduction of size, or where pipes are joined together.

(ii) Fittings for copper tubing shall be cast brass or drawn copper (sweat-soldered) or shall be approved or listed fittings for the purpose intended.

(3) *Prohibited material.* Used piping materials shall not be permitted. Those pipe dopes, solder, fluxes, oils, solvents, chemicals, or other substances that are toxic, corrosive, or otherwise detrimental to the water system shall not be used. In addition, for those manufactured homes to be connected to a public water system, all water piping shall be lead-free (as defined in section 109(c)(2) of the Safe Drinking Water Act Amendments of 1986) with solders and flux containing not more than 0.2 percent lead and pipes and pipe fittings containing not more than 8.0 percent lead.

(e) *Installation of piping—(1) Minimum requirement.* All piping equipment, appurtenances, and devices shall be installed in workmanlike manner and shall conform with the provisions and intent of this standard.

(2) *Screw pipe.* Iron pipe-size brass or galvanized iron or steel pipe fittings shall be joined with approved or listed standard pipe threads fully engaged in the fittings. Pipe ends shall be reamed

§ 3280.610

24 CFR Ch. XX (4-1-11 Edition)

to the full bore of the pipe. Pipe-joint compound shall be insoluble in water, shall be nontoxic and shall be applied to male threads only.

(3) *Solder fittings.* Joints in copper water tubes shall be made by the appropriate use of approved cast brass or wrought copper fittings, properly soldered together. The surface to be soldered shall be thoroughly cleaned bright mechanically. The joints shall be properly fluxed and made with a solder that contains no more than 0.2 percent lead.

(4) *Flared fittings.* A flaring tool shall be used to shape the ends of flared tubing to match the flare of fittings.

(5) *Plastic pipe and fittings.* Plastic pipe and fittings shall be joined by installation methods recommended by the manufacturer or in accordance with provisions of a listed standard.

(f) *Size of water supply piping—(1) Minimum size.* The size of water supply piping and branch lines shall not be less than sizes shown in the following table:

MINIMUM SIZE TUBING AND PIPE FOR WATER DISTRIBUTION SYSTEMS

Number of fixtures	Tubing (nominal)		Pipe iron pipe size (inches)
	Diameter (inches)	Outer diameter (inches)	
1	*1/4	3/8	1/2
2	3/8	1/2	1/2
3	1/2	5/8	1/2
4	1/2	5/8	1/2
5 or more	3/4	7/8	3/4

*6 ft maximum length.

Exceptions to table: 3/8 inch nominal diameter or 1/2 inch OD minimum size for clothes washing or dishwashing machines, unless larger size is recommended by the fixture manufacturer. 1/2 inch nominal diameter or 5/8 inch OD minimum size for flushometer or metering type valves unless otherwise specified in their listing. No galvanized screw piping shall be less than 1/2 inch iron pipe size.

(2) *Sizing procedure.* Both hot and cold water piping systems shall be computed by the following method:

(i) *Size of branch.* Start at the most remote outlet on any branch of the hot or cold water piping and progressively count towards the water service connection, computing the total number of fixtures supplied along each section of

piping. Where branches are joined together, the number of fixtures on each branch shall be totalled so that no fixture is counted twice. Following down the left-hand column of the preceding table a corresponding number of fixtures will be found. The required pipe or tubing size is indicated in the other columns on the same line.

(ii) A water heater, food waste disposal unit, evaporative cooler or ice maker shall not be counted as a water-using fixture when computing pipe sizes.

(g) *Line valves.* Valves, when installed in the water supply distribution system (except those immediately controlling one fixture supply) and when fully opened, shall have a cross-sectional area of the smallest orifice or opening, through which the water flows, at least equal to the cross-sectional area of the nominal size of the pipe in which the valve is installed.

[40 FR 58752, Dec. 18, 1975. Redesignated at 44 FR 20679, Apr. 6, 1979, as amended at 52 FR 4586, Feb. 12, 1987; 53 FR 23611, June 23, 1988; 58 FR 55014, Oct. 25, 1993]

§ 3280.610 Drainage systems.

(a) *General.* (1) Each fixture directly connected to the drainage system shall be installed with a water seal trap (§3280.606(a)).

(2) The drainage system shall be designed to provide an adequate circulation of air in all piping with no danger of siphonage, aspiration, or forcing of trap seals under conditions of ordinary use.

(b) *Materials—(1) Pipe.* Drainage piping shall be standard weight steel, wrought iron, brass, copper tube DWV, listed plastic, cast iron, or other listed or approved materials.

(2) *Fittings.* Drainage fittings shall be recessed drainage pattern with smooth interior waterways of the same diameter as the piping and shall be of a material conforming to the type of piping used. Drainage fittings shall be designed to provide for a 1/4 inch per foot grade in horizontal piping.

(i) Fittings for screw pipe shall be cast iron, malleable iron, brass, or listed plastic with standard pipe threads.

(ii) Fittings for copper tubing shall be cast brass or wrought copper.

(iii) Socket-type fittings for plastic piping shall comply with listed standards.

(iv) Brass or bronze adaptor or wrought copper fittings shall be used to join copper tubing to threaded pipe.

(c) *Drain outlets.* (1) Each manufactured home shall have only one drain outlet.

(2) *Clearance from drain outlet.* The drain outlet shall be provided with a minimum clearance of 3 inches in any direction from all parts of the structure or appurtenances and with not less than 18 inches unrestricted clearance directly in front of the drain outlet.

(3) *Drain connector.* The drain connector shall not be smaller than the piping to which it is connected and shall be equipped with a water-tight cap or plug matching the drain outlet. The cap or plug shall be permanently attached to the manufactured home or drain outlet.

(4) The drain outlet and drain connector shall not be less than 3 inches inside diameter.

(5) *Preassembly of drain lines.* Section(s) of the drain system, designed to be located underneath the home, are not required to be factory installed when the manufacturer designs the system for site assembly and also provides all materials and components, including piping, fittings, cement, supports, and instructions necessary for proper site installation.

(d) *Fixture connections.* Drainage piping shall be provided with approved or listed inlet fittings for fixture connections, correctly located according to the size and type of fixture to be connected.

(1) *Water closet connection.* The drain connection for each water closet shall be 3 inches minimum inside diameter and shall be fitted with an iron, brass, or listed plastic floor flange adaptor ring securely screwed, soldered or otherwise permanently attached to the drain piping, in an approved manner and securely fastened to the floor.

(2) [Reserved]

(e) *Size of drainage piping*—(1) *Fixture load.* Except as provided by § 3280.611(d), drain pipe sizes shall be determined by the type of fixture and the total number connected to each drain.

(i) A 1½ inch minimum diameter piping shall be required for one and not more than three individually vented fixtures.

(ii) A 2-inch minimum diameter piping shall be required for four or more fixtures individually vented.

(iii) A 3-inch minimum diameter piping shall be required for water closets.

(f) *Wet-vented drainage system.* Plumbing fixture traps may connect into a wet-vented drainage system which shall be designed and installed to accommodate the passage of air and waste in the same pipe.

(1) *Horizontal piping.* All parts of a wet-vented drainage system, including the connected fixture drains, shall be horizontal except for wet-vented vertical risers which shall terminate with a 1½ inch minimum diameter continuous vent. Where required by structural design, wet-vented drain piping may be offset vertically when other vented fixture drains or relief vents are connected to the drain piping at or below the vertical offsets.

(2) *Size.* A wet-vented drain pipe shall be 2 inches minimum diameter and at least one pipe size larger than the largest connected trap or fixture drain. Not more than three fixtures may connect to a 2-inch diameter wet-vented drain system.

(3) *Length of trap arm.* Fixture traps shall be located within the distance given in § 3280.611(c)(5). Not more than one trap shall connect to a trap arm.

(g) *Offsets and branch fittings*—(1) *Changes in direction.* Changes in direction of drainage piping shall be made by the appropriate use of approved or listed fittings, and shall be of the following angles: 11¼, 22½, 45, 60, or 90 degrees; or other approved or listed fittings or combinations of fittings with equivalent radius or sweep.

(2) *Horizontal to vertical.* Horizontal drainage lines, connecting with a vertical pipe shall enter through 45-degree “Y” branches, 60-degree “Y” branches, long-turn “TY” branches, sanitary “T” branches, or other approved or listed fittings or combination of fittings having equivalent sweep. Fittings having more than one branch at the same level shall not be used, unless the fitting is constructed so that

the discharge from any one branch cannot readily enter any other branch. However, a double sanitary “T” may be used when the drain line is increased not less than two pipe sizes.

(3) *Horizontal to horizontal and vertical to horizontal.* Horizontal drainage lines connecting with other horizontal drainage lines or vertical drainage lines connected with horizontal drainage lines shall enter through 45-degree “Y” branches, long-turn “TY” branches, or other approved or listed fittings or combination of fittings having equivalent sweep.

(h) *Grade of horizontal drainage piping.* Except for fixture connections on the inlet side of the trap, horizontal drainage piping shall be run in practical alignment and have a uniform grade of not less than ¼ inch per foot toward the manufactured home drain outlet. Where it is impractical, due to the structural features or arrangement of any manufactured home, to obtain a grade of ¼ inch per foot, the pipe or piping may have a grade of not less than ⅓ inch per foot, when a full size cleanout is installed at the upper end.

[40 FR 58752, Dec. 18, 1975. Redesignated at 44 FR 20679, Apr. 6, 1979, as amended at 52 FR 4586, Feb. 12, 1987; 58 FR 55015, Oct. 25, 1993]

§ 3280.611 Vents and venting.

(a) *General.* Each plumbing fixture trap shall be protected against siphonage and back pressure, and air circulation shall be ensured throughout all parts of the drainage system by means of vents installed in accordance with the requirements of this section and as otherwise required by this standard.

(b) *Materials*—(1) *Pipe.* Vent piping shall be standard weight steel, wrought iron, brass, copper tube DWV, listed plastic, cast iron or other approved or listed materials.

(2) *Fittings.* Appropriate fittings shall be used for all changes in direction or size and where pipes are joined. The material and design of vent fittings shall conform to the type of piping used.

(i) Fittings for screw pipe shall be cast iron, malleable iron, plastic, or brass, with standard pipe threads.

(ii) Fittings for copper tubing shall be cast brass or wrought copper.

(iii) Fittings for plastic piping shall be made to approved applicable standards.

(iv) Brass adaptor fittings or wrought copper shall be used to join copper tubing to threaded pipe.

(v) Listed rectangular tubing may be used for vent piping only providing it has an open cross section at least equal to the circular vent pipe required. Listed transition fittings shall be used.

(c) *Size of vent piping*—(1) *Main vent.* The drain piping for each toilet shall be vented by a 1½ inch minimum diameter vent or rectangular vent of venting cross section equivalent to or greater than the venting cross section of a 1½ inch diameter vent, connected to the toilet drain by one of the following methods:

(i) A 1½ inch diameter (min.) individual vent pipe or equivalent directly connected to the toilet drain within the distance allowed in §3280.611(c)(5), for 3-inch trap arms undiminished in size through the roof.

(ii) A 1½ inch diameter (min.) continuous vent or equivalent, indirectly connected to the toilet drain piping within the distance allowed in §3280.611(c)(5) for 3 inch trap arms through a 2-inch wet vented drain that carries the waste of not more than one fixture, or,

(iii) Two or more vented drains when at least one is wet-vented, or 2-inch diameter (minimum), and each drain is separately connected to the toilet drain. At least one of the drains shall connect within the distance allowed in §3280.611(c)(5) for 3-inch trap arms.

(2) *Vent pipe areas.* Each individually vented fixture with a 1½ inch or smaller trap shall be provided with a vent pipe equivalent in area to a 1¼ inch nominal pipe size. The main vent, toilet vent and relief vent, and the continuous vent of wet-vented systems shall have an area equivalent to 1½ inch nominal pipe size.

(3) *Common vent.* When two fixture traps located within the distance allowed from their vent have their trap arms connected separately at the same level into an approved double fitting, an individual vent pipe may serve as a common vent without any increase in size.

(4) *Intersecting vents.* Where two or more vent pipes are joined together, no

increase in size shall be required; however, the largest vent pipe shall extend full size through the roof.

(5) Distance of fixture trap from vent shall not exceed the values given in the following table:

Size of fixture drain (inches)	Distance trap to vent
1¼	4 ft. 6 in.
1½	4 ft 6 in.
2	5 ft.
3	6 ft.

(d) *Anti-siphon trap vent.* An anti-siphon trap vent may be used as a secondary vent system for plumbing fixtures protected by traps not larger than 1½ inches, when installed in accordance with the manufacturers' recommendations and the following conditions:

(1) Not more than two fixtures individually protected by the device shall be drained by a common 1½ inch drain.

(2) Minimum drain size for three or more fixtures individually protected by the device shall be 2 inches.

(3) A primary vent stack must be installed to vent the toilet drain at the point of heaviest drainage fixture unit loading.

(4) The device shall be installed in a location that permits a free flow of air and shall be accessible for inspection, maintenance, and replacement and the sealing function shall be at least 6 inches above the top of the trap arm.

(5) Materials for the anti-siphon trap vent shall be as follows:

(i) Cap and housing shall be listed acrylonitrile-butadiene-styrene, DWV grade;

(ii) Stem shall be DWV grade nylon or acetal;

(iii) Spring shall be stainless steel wire, type 302;

(iv) Sealing disc shall be neoprene, conforming to CISPI-HSN-85, the Specification for Neoprene Rubber Gaskets for HUB and Spigot Cast Iron Soil Pipe and Fittings, and ASTM C 564-88, Standard Specification for Rubber Gaskets for Case Iron Soil Pipe and Fittings, or, Silicone Rubber, Low and High Temperature and Tear Resistant, Conforming to Rubber, Silicone, FS ZZ-R-765B-1970, With 1971 Amendment

1; and Liners, Case, and Sheet, Overwrap; Water-Vapor Proof or Waterproof, Flexible, MIL-L-10547E-1975.

(e) *Grade and connections*—(1) *Horizontal vents.* Each vent shall extend vertically from its fixture "T" or point of connection with the waste piping to a point not less than 6 inches above the extreme flood level of the fixture it is venting before offsetting horizontally or being connected with any other vent pipe. Vents for horizontal drains shall connect above the centerline of the drain piping ahead (downstream) of the trap. Where required by structural conditions, vent piping may offset below the rim of the fixture at the maximum angle or height possible.

(f) *Vent terminal*—(1) *Roof extension.* Each vent pipe shall extend through its flashing and terminate vertically, undiminished in size, not less than 2 inches above the roof. Vent openings shall not be less than 3 feet away from any motor-driven air intake that opens into habitable areas.

(2) *Flashing.* The opening around each vent pipe shall be made watertight by an adequate flashing or flashing material.

(g) *Vent caps.* Vent caps, if provided, shall be of the removable type (without removing the flashing from the roof). When vent caps are used for roof space ventilation and the caps are identical to vent caps used for the plumbing system, plumbing system caps shall be identified with permanent markings.

[40 FR 58752, Dec. 18, 1975, as amended at 42 FR 961, Jan. 4, 1977. Redesignated at 44 FR 20679, Apr. 6, 1979, as amended at 58 FR 55015, Oct. 25, 1993]

§ 3280.612 Tests and inspection.

(a) *Water system.* All water piping in the water distribution system shall be subjected to a pressure test. The test shall be made by subjecting the system to air or water at 100 psi for 15 minutes without loss of pressure.

(b) *Drainage and vent system and plumbing fixtures.* The waste and vent system shall be tested by one of the three following alternate methods for evidence or indication of leakage:

(1) *Water test.* Before plumbing fixtures are connected, all of the openings into the piping shall be plugged and the entire piping system subjected to a

static water test for 15 minutes by filling it with water to the top of the highest vent opening. There shall be no evidence of leakage.

(2) *Air test.* After all fixtures have been installed, the traps filled with water, and the remaining openings securely plugged, the entire system shall be subjected to a 2-inch (manometer) water column air pressure test. If the system loses pressure, leaks may be located with smoke pumped into the system, or with soap suds spread on the exterior of the piping (Bubble test).

(3) *Flood level test.* The manufactured home shall be in a level position, all fixtures shall be connected, and the entire system shall be filled with water to the rim of the water closet bowl. (Tub and shower drains shall be plugged). After all trapped air has been released, the test shall be sustained for not less than 15 minutes without evidence of leaks. Then the system shall be unplugged and emptied. The waste piping above the level of the water closet bowl shall then be tested and show no indication of leakage when the high fixtures are filled with water and emptied simultaneously to obtain the maximum possible flow in the drain piping.

(c) *Fixture test.* The plumbing fixtures and connections shall be subjected to a flow test by filling them with water and checking for leaks and retarded flow while they are being emptied.

(d) *Shower compartments.* Shower compartments and receptors shall be tested for leaks prior to being covered by finish material. Each pan shall be filled with water to the top of the dam for not less than 15 minutes without evidence of leakage.

[40 FR 58752, Dec. 18, 1975, as amended at 42 FR 961, Jan. 4, 1977; 42 FR 54383, Oct. 5, 1977. Redesignated at 44 FR 20679, Apr. 6, 1979, as amended at 58 FR 55015, Oct. 25, 1993]

Subpart H—Heating, Cooling and Fuel Burning Systems

§ 3280.701 Scope.

Subpart H of this standard covers the heating, cooling and fuel burning equipment installed within, on, or external to a manufactured home.

§ 3280.702 Definitions.

The definitions in this subpart apply to subpart H only.

Accessible, when applied to a fixture, connection, appliance or equipment, means having access thereto, but which may require the removal of an access panel, door or similar obstruction.

Air conditioner blower coil system means a comfort cooling appliance where the condenser section is placed external to the manufactured home and evaporator section with circulating blower attached to the manufactured home air supply duct system. Provision must be made for a return air system to the evaporator/blower section. Refrigerant connection between the two parts of the system is accomplished by tubing.

Air conditioner split system means a comfort cooling appliance where the condenser section is placed external to the manufactured home and the evaporator section incorporated into the heating appliance or with a separate blower/coil section within the manufactured home. Refrigerant connection between the two parts of the system is accomplished by tubing.

Air conditioning condenser section means that portion of a refrigerated air cooling or (in the case of a heat pump) heating system which includes the refrigerant pump (compressor) and the external heat exchanger.

Air conditioning evaporator section means a heat exchanger used to cool or (in the case of a heat pump) heat air for use in comfort cooling (or heating) the living space.

Air conditioning self contained system means a comfort cooling appliance combining the condenser section, evaporator and air circulating blower into one unit with connecting ducts for the supply and return air systems.

Air duct means conduits or passageways for conveying air to or from heating, cooling, air conditioning or ventilation equipment, but not including the plenum.

Automatic pump (oil lifter) means a pump, not an integral part of the oil-burning appliance, that automatically pumps oil from the supply tank and delivers the oil under a constant head to an oil-burning appliance.

Btu. British thermal units means the quantity of heat required to raise the temperature of one pound of water one degree Fahrenheit.

Btuh means British thermal units per hour.

Burner means a device for the final conveyance of fuel or a mixture of fuel and air to the combustion zone.

Central air conditioning system means either an air conditioning split system or an external combination heating/cooling system.

Class 0 air ducts means ducts of materials and connectors having a fire-hazard classification of zero.

Class 1 air ducts means ducts of materials and connectors having a flame-spread rating of not over 25 without evidence of continued progressive combustion and a smoke-developed rating of not over 50.

Class 2 air ducts means ducts of materials and connectors having a flame-spread rating of not over 50 without evidence of continued progressive combustion and a smoke-developed rating of not over 50 for the inside surface and not over 100 for the outside surface.

Clearance means the distance between the appliance, chimney, vent, chimney or vent connector or plenum and the nearest surface.

Connector-Gas appliance: means a flexible or semi-rigid connector used to convey fuel gas between a gas outlet and a gas appliance.

Energy Efficiency Ratio (EER) means the ratio of the cooling capacity output of an air conditioner for each unit of power input.

$EER = \text{Capacity (Btuh)} / \text{Power input (watts)}$

External combination heating/cooling system means a comfort conditioning system placed external to the manufactured home with connecting ducts to the manufactured home for the supply and return air systems.

Factory-built fireplace means a hearth, fire chamber and chimney assembly composed of listed factory-built components assembled in accordance with the terms of listing to form a complete fireplace.

Fireplace stove means a chimney connected solid fuel-burning stove having part of its fire chamber open to the room.

Fuel gas piping system means the arrangement of piping, tubing, fittings, connectors, valves and devices designed and intended to supply or control the flow of fuel gas to the appliance(s).

Fuel oil piping system means the arrangement of piping, tubing, fittings, connectors, valves and devices designed and intended to supply or control the flow of fuel oil to the appliance(s).

Gas clothes dryer means a device used to dry wet laundry by means of heat derived from the combustion of fuel gases.

Gas refrigerator means a gas-burning appliance which is designed to extract heat from a suitable chamber.

Gas supply connection means the terminal end or connection to which a gas supply connector is attached.

Gas supply connector, manufactured home means a listed flexible connector designed for connecting the manufactured home to the gas supply source.

Gas vents means factory-built vent piping and vent fittings listed by an approved testing agency, that are assembled and used in accordance with the terms of their listings, for conveying flue gases to the outside atmosphere.

(1) *Type B gas vent* means a gas vent for venting gas appliances with draft hoods and other gas appliances listed for use with Type B gas vents.

(2) *Type BW gas vent* means a gas vent for venting listed gas-fired vented wall furnaces.

Heat producing appliance means all heating and cooking appliances and fuel burning appliances.

Heating appliance means an appliance for comfort heating or for domestic water heating.

Liquefied petroleum gases. The terms *Liquefied petroleum gases*, *LPG* and *LP-Gas* as used in this standard shall mean and include any material which is composed predominantly of any of the following hydrocarbons, or mixtures of them: propane, propylene butanes (normal butane or isobutane), and butylenes.

Plenum means an air compartment which is part of an air-distributing system, to which one or more ducts or outlets are connected.

§ 3280.703

(1) Furnace supply plenum is a plenum attached directly to, or an integral part of, the air supply outlet of the furnace.

(2) Furnace return plenum is a plenum attached directly to, or an integral part of, the return inlet of the furnace.

Quick-disconnect device means a hand-operated device which provides a means for connecting and disconnecting a gas supply or connecting gas systems and which is equipped with an automatic means to shut off the gas supply when the device is disconnected.

Readily accessible means direct access without the necessity of removing any panel, door, or similar obstruction.

Roof jack means that portion of a manufactured home heater flue or vent assembly, including the cap, insulating means, flashing, and ceiling plate, located in and above the roof of a manufactured home.

Sealed combustion system appliance means an appliance which by its inherent design is constructed so that all air supplied for combustion, the combustion system of the appliance, and all products of combustion are completely isolated from the atmosphere of the space in which it is installed.

Water heater means an appliance for heating water for domestic purposes other than for space heating.

[40 FR 58752, Dec. 18, 1975. Redesignated at 44 FR 20679, Apr. 6, 1979, as amended at 52 FR 4586, Feb. 12, 1987; 58 FR 55015, Oct. 25, 1993]

§ 3280.703 Minimum standards.

Heating, cooling and fuel burning appliances and systems in manufactured homes shall be free of defects, and shall conform to applicable standards in the following table unless otherwise specified in this standard. (See §3280.4) When more than one standard is referenced, compliance with any one such standard shall meet the requirements of this standard.

APPLIANCES

Heating and Cooling Equipment, Second Edition, with 1999 revisions—UL 1995, 1995.

Liquid Fuel-Burning Heating Appliances for Manufactured Homes and Recreational Vehicles, Seventh Edition, with 1997 revisions—UL 307A—1995.

24 CFR Ch. XX (4–1–11 Edition)

Fixed and Location-Dedicated Electric Room Heaters, Second Edition, with 1998 revisions—UL 2021—1997.

Electric Baseboard Heating Equipment, Fourth Edition, with 1998 revisions—UL 1042—1994.

Electric Central Air Heating Equipment—UL 1096—Fourth Edition—1986 with revisions July 16, 1986, and January 30, 1988.

Gas Burning Heating Appliances for Manufactured Homes and Recreational Vehicles, Fourth Edition, with 1998 revisions—UL 307B—1995.

Gas Clothes Dryers Volume 1, Type 1 Clothes Dryers—ANSI Z21.5.1—/CSA 7.1—M99—1999 with Addendum Z21.5.1a—1999.

Gas Fired Absorption Summer Air Conditioning Appliances—ANSI Z21.40.1/CGA 2.91—M961996.

Gas-Fired Central Furnaces (Except Direct Vent System Central Furnaces)—ANSI Z21.47—1990 with Addendum Z21.47a—1990 and Z21.47b—1992.

Household Cooking Gas Appliances—ANSI Z21.1—2000.

Refrigerators Using Gas Fuel—ANSI Z21.19—1990, with Addendum ANSI Z21.19a—1992 and Z21.19b—1995.

Gas Water Heaters—Volume 1, Storage Water Heaters with Input Ratings of 75,000 BTU per hour or Less—ANSI Z21.10.1—1998 with Addendum Z21.10.1a—2000.

Household Electric Storage Tank Water Heaters, Tenth Edition—UL 174—1996, with 1997 revisions.

FERROUS PIPE AND FITTINGS

Standard Specification for Pipe, Steel, Black and Hot-Dipped, Zinc-Coated, Welded and Seamless—ASTM A53—93.

Standard Specification for Electric-Resistance-Welded Coiled Steel Tubing for Gas and Fuel Oil Lines—ASTM A539—1999.

Pipe Threads, General Purpose (Inch)—ANSI/ASME B1.20.1—1983.

Welding and Seamless Wrought Steel Pipe—ANSI/ASME B36.10—1979.

NONFERROUS PIPE, TUBING, AND FITTINGS

Standard Specification for Seamless Copper Water Tube—ASTM B88—93.

Standard Specification for Seamless Copper Tube for Air Conditioning and Refrigeration Field Service—ASTM B280, A—95.

Connectors for Gas Appliances—ANSI Z21.24/CGA 6.10—M97—1997.

Manually Operated Gas Valves for Appliances, Appliance Connector Valves and Hose End Valves—ANSI Z21.15/CGA 9.1—M97—1997.

Standard for Gas Supply Connectors for Manufactured Homes—IAPMO TSC 9—1997.

Standard Specification for General Requirements for Wrought Seamless Copper and Copper-Alloy Tubes—ASTM B251—93.

Standard Specification for Seamless Copper Pipe, Standard Sizes—ASTM B42-93.

MISCELLANEOUS

Factory-Made Air Ducts and Connectors, Ninth Edition—UL 181, 1996 with 1998 revisions.

Standard for Safety Closure Systems for use with Rigid Air Ducts and Air Connectors, UL 181A, 1994, with 1998 revisions.

Standard for Safety Closure Systems for use with Flexible Air Ducts and Air Connectors, First Edition—UL 181B, 1995, with 1998 revisions.

Tube Fittings for Flammable and Combustible Fluids, Refrigeration Service, and Marine Use, Sixth Edition—UL 109-1997, with 2001 revisions.

Pigtails and Flexible Hose Connectors for LP-Gas, Seventh Edition—UL 569, 1995 with 2001 revisions.

Roof Jacks for Manufactured Homes and Recreational Vehicles, Eighth Edition—UL 311, 1994, with 1998 revisions.

Relief Valves and Automatic Gas Shutoff Devices for Hot Water Supply Systems—ANSI Z21.22/CSA 4.4-M99, 1999.

Automatic Gas Ignition Systems and Components—ANSI Z21.20 with Addendum Z21.20a-2000.

Automatic Valves for Gas Appliances—ANSI Z21.21/CSA 6.5-2000.

Gas Appliance Thermostats—ANSI Z21.23-1989, with Addendum Z21.23a-1991.

Gas Vents, Ninth Edition—UL 441, 1996 with 1999 revisions.

Standard for the Installation of Oil-Burning Equipment, NFPA 31, 1997 Edition.

National Fuel Gas Code—NFPA 54-2002/ANSI Z223.1-2002.

Warm Air Heating and Air Conditioning Systems, NFPA 90B, 1996 Edition.

Liquefied Petroleum Gas Code, NFPA 58-2001 Edition.

Flares for Tubing—SAE-J533b-1992.

Factory-Built Chimneys for Residential Type and Building Heating Appliances, Ninth Edition—UL 103, 1995, with 1999 revisions.

Factory-Built Fireplaces, Seventh Edition—UL 127-1996, with 1999 revisions.

Solid-Fuel Type Room Heaters, Fifth Edition—UL 1482, 1995, with 2000 revisions.

Fireplace Stoves, Eighth Edition, with 2000 revisions—UL 737, 1996.

Unitary Air-Conditioning and Air-Source Heat Pump Equipment—ANSI/ARI 210/240-89.

AGA Requirements for Gas Connectors for Connection of Fixed Appliances for Outdoor Installation, Park Trailers, and Manufactured (Mobile) Homes to the Gas Supply—No. 3-87.

[58 FR 55015, Oct. 25, 1993, as amended at 70 FR 72046, Nov. 30, 2005]

§ 3280.704 Fuel supply systems.

(a) *LP—Gas system design and service line pressure.* (1) Systems shall be of the vapor-withdrawal type.

(2) Gas, at a pressure not over 14 inches water column ($\frac{1}{2}$ psi), shall be delivered from the system into the gas supply connection.

(b) *LP-gas containers*—(1) *Maximum capacity.* No more than two containers having an individual water capacity of not more than 105 pounds (approximately 45 pounds LP-gas capacity), shall be installed on or in a compartment of any manufactured home.

(2) *Construction of containers.* Containers shall be constructed and marked in accordance with the specifications for LP-Gas Containers of the U.S. Department of Transportation (DOT) or the Rules for Construction of Pressure Vessels 1986, ASME Boiler and Pressure Vessel Code section VIII, Division 1 ASME Containers shall have a design pressure of at least 312.5 psig.

(i) Container supply systems shall be arranged for vapor withdrawal only.

(ii) Container openings for vapor withdrawal shall be located in the vapor space when the container is in service or shall be provided with a suitable internal withdrawal tube which communicates with the vapor space on or near the highest point in the container when it is mounted in service position, with the vehicle on a level surface. Containers shall be permanently and legibly marked in a conspicuous manner on the outside to show the correct mounting position and the position of the service outlet connection. The method of mounting in place shall be such as to minimize the possibility of an incorrect positioning of the container.

(3) *Location of LP-gas containers and systems.* (i) LP-gas containers shall not be installed, nor shall provisions be made for installing or storing any LP-gas container, even temporarily, inside any manufactured home except for listed, completely self-contained hand torches, lanterns, or similar equipment with containers having a maximum water capacity of not more than 2½ pounds (approximately one pound LP-gas capacity).

(ii) Containers, control valves, and regulating equipment, when installed,

shall be mounted on the “A” frame of the manufactured home, or installed in a compartment that is vaportight to the inside of the manufactured home and accessible only from the outside. The compartment shall be ventilated at top and bottom to facilitate diffusion of vapors. The compartment shall be ventilated with two vents having an aggregate area of not less than two percent of the floor area of the compartment and shall open unrestricted to the outside atmosphere. The required vents shall be equally distributed between the floor and ceiling of the compartment. If the lower vent is located in the access door or wall, the bottom edge of the vent shall be flush with the floor level of the compartment. The top vent shall be located in the access door or wall with the bottom of the vent not more than 12 inches below the ceiling level of the compartment. All vents shall have an unrestricted discharge to the outside atmosphere. Access doors or panels of compartments shall not be equipped with locks or require special tools or knowledge to open.

(iii) Permanent and removable fuel containers shall be securely mounted to prevent jarring loose, slipping or rotating and the fastenings shall be designed and constructed to withstand static loading in any direction equal to twice the weight of the tank and attachments when filled with fuel, using a safety factor of not less than four based on the ultimate strength of the material to be used.

(4) *LP-gas container valves and accessories.* (i) Valves in the assembly of a two-cylinder system shall be arranged so that replacement of containers can be made without shutting off the flow of gas to the appliance(s). This provision is not to be construed as requiring an automatic change-over device.

(ii) Shutoff valves on the containers shall be protected as follows, in transit, in storage, and while being moved into final utilization by setting into a recess of the container to prevent possibility of their being struck if container is dropped upon a flat surface, or by ventilated cap or collar, fastened to the container, capable of withstanding a blow from any direction equivalent to that of a 30-pound weight dropped 4

feet. Construction shall be such that the blow will not be transmitted to the valve.

(iii) [Reserved]

(iv) Regulators shall be connected directly to the container shutoff valve outlets or mounted securely by means of a support bracket and connected to the container shutoff valve or valves with listed high pressure connections. If the container is permanently mounted the connector shall be as required above or with a listed semi-rigid tubing connector.

(5) *LP-gas safety devices.* (i) DOT containers must be provided with safety relief devices as required by the regulation of the U.S. Department of Transportation. ASME containers must be provided with relief valves in accordance with subsection 2.3.2 of NFPA 58-2001, Standard for the Storage and Handling Liquefied Petroleum Gases. Safety relief valves must have direct communication with the vapor space of the vessel.

(ii) The delivery side of the gas pressure regulator shall be equipped with a safety relief device set to discharge at a pressure not less than two times and not more than three times the delivery pressure of the regulator.

(iii) Systems mounted on the “A” frame assembly shall be so located that the discharge from the safety relief devices shall be into the open air and not less than three feet horizontally from any opening into the manufactured home below the level of such discharge.

(iv) Safety relief valves located within liquefied petroleum gas container compartments may be less than three feet from openings provided the bottom vent of the compartment is at the same level or lower than the bottom of any opening into the vehicle, or the compartment is not located on the same wall plane as the opening(s) and is at least two feet horizontally from such openings.

(6) *LP-gas system enclosure and mounting.* (i) Housings and enclosures shall be designed to provide proper ventilation at least equivalent to that specified in §3280.704(b)(3)(ii).

(ii) Doors, hoods, domes, or portions of housings and enclosures required to be removed or opened for replacement of containers shall incorporate means

for clamping them firmly in place and preventing them from working loose during transit.

(iii) Provisions shall be incorporated in the assembly to hold the containers firmly in position and prevent their movement during transit.

(iv) Containers shall be mounted on a substantial support or a base secured firmly to the vehicle chassis. Neither the container nor its support shall extend below the manufactured home frame.

(c) *Oil tanks*—(1) *Installation*. Oil tanks and listed automatic pumps (oil lifters) installed for gravity flow of oil to heating equipment shall be installed so that the top of the tank is no higher than 8 feet above the appliance oil control and the bottom of the tank is not less than 18 inches above the appliance oil control.

(2) *Auxiliary oil storage tank*. Oil supply tanks affixed to a manufactured home shall be so located as to require filling and draining from the outside and shall be in a place readily available for inspection. If the fuel supply tank is located in a compartment of a manufactured home, the compartment shall be ventilated at the bottom to permit diffusion of vapors and shall be insulated from the structural members of the body. Tanks so installed shall be provided with an outside fill and vent pipe and an approved liquid level gage.

(3) *Shutoff valve*. A readily accessible, approved manual shutoff valve shall be installed at the outlet of an oil supply tank. The valve shall be installed to close against the supply.

(4) *Fuel oil filters*. All oil tanks shall be equipped with an approved oil filter or strainer located downstream from the tank shutoff valve. The fuel oil filter or strainer shall contain a sump with a drain for the entrapment of water.

[40 FR 58752, Dec. 18, 1975. Redesignated at 44 FR 20679, Apr. 6, 1979, as amended at 47 FR 49390, Nov. 1, 1982; 52 FR 4587, Feb. 12, 1987; 58 FR 55016, Oct. 25, 1993; 70 FR 72050, Nov. 30, 2005]

§ 3280.705 Gas piping systems.

(a) *General*. The requirements of this section shall govern the installation of all fuel gas piping attached to any manufactured home. The gas piping

supply system shall be designed for a pressure not exceeding 14 inch water column ($\frac{1}{2}$ psi) and not less than 7 inch water column ($\frac{1}{4}$ psi). The manufacturer shall indicate in his written installation instructions the design pressure limitations for safe and effective operation of the gas piping system. None of the requirements listed in this section shall apply to the piping supplied as a part of an appliance. All exterior openings around piping, ducts, plenums or vents shall be sealed to resist the entrance of rodents.

(b) *Materials*. All materials used for the installation, extension, alteration, or repair of any gas piping system shall be new and free from defects or internal obstructions. It shall not be permissible to repair defects in gas piping or fittings. Inferior or defective materials shall be removed and replaced with acceptable material. The system shall be made of materials having a melting point of not less than 1,450 F, except as provided in § 3280.705(e). They shall consist of one or more of the materials described in § 3280.705(b) (1) through (4).

(1) Steel or wrought-iron pipe shall comply with ANSI Standard B36.10-1979, Welded and Seamless Wrought Steel Pipe. Threaded brass pipe in iron pipe sizes may be used. Threaded brass pipe shall comply with ASTM B43-91, Standard Specification for Seamless Red Brass Pipe, Standard Sizes.

(2) Fittings for gas piping shall be wrought iron, malleable iron, steel, or brass (containing not more than 75 percent copper).

(3) Copper tubing must be annealed type, Grade K or L, conforming to the Standard Specification for Seamless Copper Water Tube, ASTM B88-93, or must comply with the Standard Specification for Seamless Copper Tube for Air Conditioning and Refrigeration Service, ASTM B280-1995. Copper tubing must be internally tinned.

(4) Steel tubing must have a minimum wall thickness of 0.032 inch for tubing of $\frac{1}{2}$ inch diameter and smaller and 0.049 inch for diameters $\frac{1}{2}$ inch and larger. Steel tubing must be in accordance with ASTM Standard Specification for Electric-Resistance-Welded Coiled Steel Tubing for Gas and Fuel

§ 3280.705

Oil Lines, ASTM A539-1999, and must be externally corrosion protected.

(c) *Piping design.* Each manufactured home requiring fuel gas for any purpose shall be equipped with a natural gas piping system acceptable for LP-gas. Where fuel gas piping is to be installed in more than one section of an expandable or multiple unit home, the design and construction of the crossover(s) shall be as follows:

(1) All points of crossover shall be readily accessible from the exterior of the home.

(2) The connection(s) between units must be made with a connector(s) listed for exterior use or direct plumbing sized in accordance with §3280.705(d). A shutoff valve of the non-displaceable rotor type conforming to ANSI Z21.15-1997, Manually Operated Gas Valves for Appliances, Appliances Connector Valves, and Hose End Valves, suitable for outdoor use must be installed at each crossover point upstream of the connection.

(3) The connection(s) may be made by a listed quick disconnect device which shall be designed to provide a positive seal of the supply side of the gas system when such device is separated.

(4) The flexible connector, direct plumbing pipe, or "quick disconnect" device shall be provided with protection from mechanical and impact damage and located to minimize the possibility of tampering.

(5) For gas line cross over connections made with either hard pipe or flexible connectors, the crossover point(s) shall be capped on the supply side to provide a positive seal and covered on the other side with a suitable protective covering.

(6) Suitable protective coverings for the connection device(s) when separated, shall be permanently attached to the device or flexible connector.

(7) When a quick disconnect device is installed, a 3 inch by 1¾ inch minimum size tag made of etched, metal-stamped or embossed brass, stainless steel, anodized or alclad aluminum not less than 0.020 inch thick or other approved material (e.g., 0.005 inch plastic laminates) shall be permanently attached on the exterior wall adjacent to the access to the "quick disconnect" device. Each tag shall be legibly inscribed with

24 CFR Ch. XX (4-1-11 Edition)

the following information using letters no smaller than ¼ inch high:

Do Not Use Tools To Separate the "Quick-Disconnect" Device

(d) *Gas pipe sizing.* Gas piping systems shall be sized so that the pressure drop to any appliance inlet connection from any gas supply connection, when all appliances are in operation at maximum capacity, is not more than 0.5 inch water column as determined on the basis of test, or in accordance with table 3280.705(d). When determining gas pipe sizing in the table, gas shall be assumed to have a specific gravity of 0.65 and rated at 1000 B.T.U. per cubic foot. The natural gas supply connection(s) shall be not less than the size of the gas piping but shall be not smaller than ¾ inch nominal pipe size.

(e) *Joints for gas pipe.* All pipe joints in the piping system, unless welded or brazed, shall be threaded joints that comply with Pipe Threads, General Purpose (Inch), adopted 25 October 1984, ANSI/ASME B1.20.1-1983. Right and left nipples or couplings shall not be used. Unions, if used, shall be of ground joint type. The material used for welding or brazing pipe connections shall have a melting temperature in excess of 1,000 F.

(f) *Joints for tubing.* (1) Tubing joints shall be made with either a single or a double flare of 45 degrees in accordance with Flares For Tubing, SAE-J533b-1972 or with other listed vibration-resistant fittings, or joints may be brazed with material having a melting point exceeding 1,000 F. Metallic ball sleeve compression-type tubing fittings shall not be used.

(2) Steel tubing joints shall be made with a double-flare in accordance with Flares For Tubing, SAE-J533b-1972.

(g) *Pipe joint compound.* Screw joints shall be made up tight with listed pipe joint compound, insoluble in liquefied petroleum gas, and shall be applied to the male threads only.

(h) *Concealed tubing.* Tubing shall not be run inside walls, floors, partitions, or roofs. Where tubing passes through walls, floors, partitions, roofs, or similar installations, such tubing shall be protected by the use of weather resistant grommets that shall snugly fit

Office of Asst. Sec. for Housing, HUD

§ 3280.705

both the tubing and the hole through
which the tubing passes.

PART I—MAXIMUM CAPACITY OF DIFFERENT SIZES OF PIPE AND TUBING IN THOUSANDS OF BTU'S PER HOUR OF NATURAL GAS FOR GAS PRESSURES OF 0.5 PSIG OR LESS AND A MAXIMUM PRESSURE DROP OF 1/2 INCH WATER COLUMN

I.D.	Iron pipe sizes—Length in feet										Tubing—Length in feet										
	10	20	30	40	50	60	70	80	90	100	O.D.	10	20	30	40	50	60	70	80	90	100
1/4"	43	29	24	20	18	16	15	14	13	12	3/8"	27	18	15	13	11	10	9	9	8	8
3/8"	95	65	52	45	40	36	33	31	29	27	1/2"	56	38	31	26	23	21	19	18	17	16
1/2"	175	120	97	82	73	66	61	57	53	50	5/8"	113	78	62	53	47	43	39	37	34	33
3/4"	360	250	200	170	151	138	125	118	110	103	3/4"	197	136	109	93	83	75	69	64	60	57
1"	680	465	375	320	285	260	240	220	215	195	7/8"	280	193	155	132	117	106	98	91	85	81

PART II [RESERVED]

(i) *Concealed joints.* Piping or tubing joints shall not be located in any floor, wall partition, or similar concealed construction space.

(j) *Gas supply connections.* When gas appliances are installed, at least one gas supply connection shall be provided on each home. The connection shall not be located beneath an exit door. Where more than one connection is provided, the piping system shall be sized to provide adequate capacity from each supply connection.

(k) *Identification of gas supply connections.* Each manufactured home shall have permanently affixed to the exterior skin at or near each gas supply connection or the end of the pipe, a tag of 3 inches by 1¾ inches minimum size, made of etched, metal-stamped or embossed brass, stainless steel, anodized or alclad aluminum not less than 0.020 inch thick, or other approved material (e.g., 0.005 inch plastic laminates), which reads as follows. The connector capacity indicated on this tag shall be equal to or greater than the total Btuh rating of all intended gas appliances.

COMBINATION LP-GAS AND NATURAL GAS SYSTEM

This gas piping system is designed for use of either liquefied petroleum gas or natural gas.

NOTICE: BEFORE TURNING ON GAS BE CERTAIN APPLIANCES ARE DESIGNED FOR THE GAS CONNECTED AND ARE EQUIPPED WITH CORRECT ORIFICES. SECURELY CAP THIS INLET WHEN NOT CONNECTED FOR USE.

When connecting to lot outlet, use a listed gas supply connector for mobile homes rated at 100,000 Btuh or more; 250,000 Btuh or more.

Before turning on gas, make certain all gas connections have been made tight, all appliance valves are turned off, and any unconnected outlets are capped.

After turning on gas, test gas piping and connections to appliances for leakage with soapy water or bubble solution, and light all pilots.

The connector capacity indicated on this tag shall be equal to or greater than the total Btuh rating of all intended gas appliances.

(1) *LP-gas supply connectors.* (1) A listed LP-Gas flexible connection conforming to UL 569-1995, Pigtailed and Flexible Hose Connectors for LP Gas, or equal must be supplied when LP-Gas cylinders(s) and regulator(s) are supplied.

(2) *Appliance connections.* All gas burning appliances shall be connected to the fuel piping. Materials as provided in §3280.705(b) or listed appliance connectors shall be used. Listed appliance connectors when used shall not run through walls, floors, ceilings or partitions, except for cabinetry, and shall be 3 feet or less in length or 6 feet or less for cooking appliances. Connectors of aluminum shall not be used outdoors. A manufactured home containing a combination LP-natural-gas-system may be provided with a gas outlet to supply exterior appliances when installed in accordance with the following:

(i) No portion of the completed installation shall project beyond the wall of the manufactured home.

(ii) The outlet must be provided with an approved quick-disconnect device, which must be designed to provide a positive seal on the supply side of the gas system when the appliance is disconnected. A shutoff valve of the non-displaceable rotor type conforming to ANSI Z21.15-1997, Manually Operated Gas Valves, must be installed immediately upstream of the quick-disconnect device. The complete device must be provided as part of the original installation.

(iii) Protective caps or plugs for the "quick-disconnect" device, when disconnected, shall be permanently attached to the manufactured home adjacent to the device.

(iv) A tag shall be permanently attached to the outside of the exterior wall of the manufactured home as close as possible to the gas supply connection. The tag shall indicate the type of gas and the Btuh capacity of the outlet and shall be legibly inscribed as follows:

THIS OUTLET IS DESIGNED FOR USE WITH GAS PORTABLE APPLIANCES WHOSE TOTAL INPUT DO NOT EXCEED _____ BTUH. REPLACE PROTECTIVE COVERING OVER CONNECTOR WHEN NOT IN USE.

§ 3280.706

(3) *Valves.* A shutoff valve must be installed in the fuel piping at each appliance inside the manufactured home structure, upstream of the union or connector in addition to any valve on the appliance and so arranged to be accessible to permit servicing of the appliance and removal of its components. The shutoff valve must be located within 6 feet of any cooking appliance and within 3 feet of any other appliance. A shutoff valve may serve more than one appliance if located as required by this paragraph (3). The shutoff valve must be of the non-displaceable rotor type and conform to ANSI Z21.15-1997, Manually Operated Gas Valves.

(4) *Gas piping system openings.* All openings in the gas piping system shall be closed gas-tight with threaded pipe plugs or pipe caps.

(5) *Electrical ground.* Gas piping shall not be used for an electrical ground.

(6) *Couplings.* Pipe couplings and unions shall be used to join sections of threaded piping. Right and left nipples or couplings shall not be used.

(7) *Hangers and supports.* All gas piping shall be adequately supported by galvanized or equivalently protected metal straps or hangers at intervals of not more than 4 feet, except where adequate support and protection is provided by structural members. Solid-iron-pipe gas supply connection(s) shall be rigidly anchored to a structural member within 6 inches of the supply connection(s).

(8) *Testing for leakage.* (i) Before appliances are connected, piping systems shall stand a pressure of at least six inches mercury or three PSI gage for a period of not less than ten minutes without showing any drop in pressure. Pressure shall be measured with a mercury manometer or slope gage calibrated so as to be read in increments of not greater than one-tenth pound, or an equivalent device. The source of normal operating pressure shall be isolated before the pressure tests are made. Before a test is begun, the temperature of the ambient air and of the piping shall be approximately the same, and constant air temperature be maintained throughout the test.

(ii) After appliances are connected, the piping system shall be pressurized

24 CFR Ch. XX (4-1-11 Edition)

to not less than 10 inches nor more than 14 inches water column and the appliance connections tested for leakage with soapy water or bubble solution.

[40 FR 58752, Dec. 18, 1975, as amended at 42 FR 54383, Oct. 5, 1977. Redesignated at 44 FR 20679, Apr. 6, 1979, as amended at 52 FR 4587, Feb. 12, 1987; 58 FR 55016, Oct. 25, 1993; 70 FR 72050, Nov. 30, 2005]

§ 3280.706 Oil piping systems.

(a) *General.* The requirements of this section shall govern the installation of all liquid fuel piping attached to any manufactured home. None of the requirements listed in this section shall apply to the piping in the appliance(s).

(b) *Materials.* All materials used for the installation extension, alteration, or repair, of any oil piping systems shall be new and free from defects or internal obstructions. The system shall be made of materials having a melting point of not less than 1,450 F, except as provided in § 280.706(d) and (e). They shall consist of one or more of the materials described in § 3280.706(b) (1) through (4).

(1) Steel or wrought-iron pipe shall comply with ANSI B 36.10-1979, Welded and Seamless Wrought Steel Pipe. Threaded copper or brass pipe in iron pipe sizes may be used.

(2) Fittings for oil piping shall be wrought-iron, malleable iron, steel, or brass (containing not more than 75 percent copper).

(3) Copper tubing must be annealed type, Grade K or L conforming to the Standard Specification for Seamless Copper Water Tube, ASTM B88-93, or shall comply with ASTM B280-1995, Standard Specification for Seamless Copper Tube for Air Conditioning and Refrigeration Field Service.

(4) Steel tubing shall have a minimum wall thickness of 0.032 inch for diameters up to ½ inch and 0.049 inch for diameters ½ inch and larger. Steel tubing shall be constructed in accordance with the Specification for Electric-Resistance-Welded Coiled Steel Tubing for Gas and Field Oil Lines, ASTM, A539-90a, and shall be externally corrosion protected.

(c) *Size of oil piping.* The minimum size of all fuel oil tank piping connecting outside tanks to the appliance

shall be no smaller than $\frac{3}{8}$ inch OD copper tubing or $\frac{1}{4}$ inch IPS. If No. 1 fuel oil is used with a listed automatic pump (fuel lifter), copper tubing shall be sized as specified by the pump manufacturer.

(d) *Joints for oil piping.* All pipe joints in the piping system, unless welded or brazed, shall be threaded joints which comply with ANSI/ASME B1.20.1-1983, Pipe Threads, General Purpose (Inch). The material used for brazing pipe connections shall have a melting temperature in excess of 1,000 F.

(e) *Joints for tubing.* Joints in tubing shall be made with either a single or double flare of the proper degree, as recommended by the tubing manufacturer, by means of listed tubing fittings, or brazed with materials having a melting point in excess of 1,000 F.

(f) *Pipe joint compound.* Threaded joints shall be made up tight with listed pipe joint compound which shall be applied to the male threads only.

(g) *Couplings.* Pipe couplings and unions shall be used to join sections of threaded pipe. Right and left nipples or couplings shall not be used.

(h) *Grade of piping.* Fuel oil piping installed in conjunction with gravity feed systems to oil heating equipment shall slope in a gradual rise upward from a central location to both the oil tank and the appliance in order to eliminate air locks.

(i) *Strap hangers.* All oil piping shall be adequately supported by galvanized or equivalently protected metal straps or hangers at intervals of not more than 4 feet, except where adequate support and protection is provided by structural members. Solid-iron-pipe oil supply connection(s) shall be rigidly anchored to a structural member within 6 inches of the supply connection(s).

(j) *Testing for leakage.* Before setting the system in operation, tank installations and piping shall be checked for oil leaks with fuel oil of the same grade that will be burned in the appliance. No other material shall be used for testing fuel oil tanks and piping. Tanks shall be filled to maximum ca-

capacity for the final check for oil leakage.

[40 FR 58752, Dec. 18, 1975. Redesignated at 44 FR 20679, Apr. 6, 1979, as amended at 52 FR 4588, Feb. 12, 1987; 58 FR 55017, Oct. 25, 1993; 70 FR 72050, Nov. 30, 2005]

§ 3280.707 Heat producing appliances.

(a) Heat-producing appliances and vents, roof jacks and chimneys necessary for their installation in manufactured homes shall be listed or certified by a nationally recognized testing agency for use in manufactured homes.

(1) A manufactured home shall be provided with a comfort heating system.

(i) When a manufactured home is manufactured to contain a heating appliance, the heating appliance shall be installed by the manufacturer of the manufactured home in compliance with applicable sections of this subpart.

(ii) When a manufactured home is manufactured for field application of an external heating or combination heating/cooling appliance, preparation of the manufactured home for this external application shall comply with the applicable sections of this part.

(2) Gas and oil burning comfort heating appliances shall have a flue loss of not more than 25 percent, and a thermal efficiency of not less than that specified in nationally recognized standards (See § 3280.703).

(b) Fuel-burning heat-producing appliances and refrigeration appliances, except ranges and ovens, shall be of the vented type and vented to the outside.

(c) Fuel-burning appliances shall not be converted from one fuel to another fuel unless converted in accordance with the terms of their listing and the appliance manufacturer's instructions.

(d) *Performance efficiency.* (1) All automatic electric storage water heaters installed in manufactured homes shall have a standby loss not exceeding 43 watts/meter² (4 watts/ft²) of tank surface area. The method of test for standby loss shall be as described in section 4.3.1 of Household Automatic Electric Storage Type Water Heaters, ANSI C72.1-1972.

§ 3280.708

24 CFR Ch. XX (4-1-11 Edition)

(2) All gas and oil-fired automatic storage water heaters shall have a recovery efficiency, E, and a standby loss, S, as described below. The method of test of E and S shall be as described in section 2.7 of Gas Water heaters, Vol. I, Storage Water Heaters with Input/Ratings of 75,000 BTU per hour or less, ANSI Z21.10.1-1990, with addendums Z21.10.1a-1991 and Z21.10.1b-1992 except that for oil-fired units, CF=1.0, Q=total gallons of oil consumed and H=total heating value of oil in BTU/gallon.

Storage capacity in gallons	Recovery efficiency	Standby loss
Less than 25	At least 75 percent.	Not more than 7.5 percent.
25 up to 35 ..	00	Not more than 7 percent.
35 or more ...	00	Not more than 6 percent.

(e) Each space heating, cooling or combination heating and cooling system shall be provided with at least one readily adjustable automatic control for regulation of living space temperature. The control shall be placed a minimum of 3 feet from the vertical edge of the appliance compartment door. It shall not be located on an exterior wall or on a wall separating the appliance compartment from a habitable room.

(f) *Oil-fired heating equipment.* All oil-fired heating equipment must conform to Liquid Fuel-burning Heating Appliances for Manufactured Homes and Recreational Vehicles, UL 307A-1995, with 1997 revisions, and be installed in accordance with Standard for the Installation of Oil Burning Equipment, NFPA 31-1997. Regardless of the requirements of the above-referenced standards, or any other standards referenced in this part, the following are not required:

- (1) External switches or remote controls which shut off the burner or the flow of oil to the burner, or
- (2) An emergency disconnect switch to interrupt electric power to the equipment under conditions of excessive temperature.

[40 FR 58752, Dec. 17, 1975, as amended at 42 FR 54383, Oct. 5, 1977. Redesignated at 44 FR 20679, Apr. 6, 1979, as amended at 47 FR 49391, Nov. 1, 1982; 52 FR 4588, Feb. 12, 1987; 52 FR 47553, Dec. 15, 1987; 58 FR 55017, Oct. 25, 1993; 70 FR 72050, Nov. 30, 2005]

§ 3280.708 Exhaust duct system and provisions for the future installation of a clothes dryer.

(a) *Clothes dryers.* (1) All gas and electric clothes dryers shall be exhausted to the outside by a moisture-lint exhaust duct and termination fitting. When the clothes dryer is supplied by the manufacturer, the exhaust duct and termination fittings shall be completely installed by the manufacturer. However, if the exhaust duct system is subject to damage during transportation, it need not be completely installed at the factory when:

- (i) The exhaust duct system is connected to the clothes dryer, and
- (ii) A moisture lint exhaust duct system is roughed in and installation instructions are provided in accordance with paragraph (b)(3) or (c) of this section.

(2) A clothes dryer moisture-lint exhaust duct shall not be connected to any other duct, vent or chimney.

(3) The exhaust duct shall not terminate beneath the manufactured home.

(4) Moisture-lint exhaust ducts shall not be connected with sheet metal screws or other fastening devices which extend into the interior of the duct.

(5) Moisture-lint exhaust duct and termination fittings shall be installed in accordance with the appliance manufacturer's printed instructions.

(b) *Provisions for future installation of a gas clothes dryer.* A manufactured home may be provided with "stubbed in" equipment at the factory to supply a gas clothes dryer for future installation by the owner provided it complies with the following provisions:

(1) The "stubbed in" gas outlet shall be provided with a shutoff valve, the outlet of which is closed by threaded pipe plug or cap;

(2) The "stubbed in" gas outlet shall be permanently labeled to identify it for use only as the supply connection for a gas clothes dryer;

(3) A moisture lint duct system consisting of a complete access space (hole) through the wall or floor cavity with a cap or cover on the interior and exterior of the cavity secured in such a manner that they can be removed by a common household tool shall be provided. The cap or cover in place shall limit air infiltration and be designed to

resist the entry of water or rodents. The manufacturer is not required to provide the moisture-lint exhaust duct or the termination fitting. The manufacturer shall provide written instructions to the owner on how to complete the exhaust duct installation in accordance with provisions of § 3280.708(a)(1) through (5).

(c) *Provisions for future installation of electric clothes dryers.* When wiring is installed to supply an electric clothes dryer for future installation by the owner, the manufacturer shall:

(1) Provide a roughed in moisture-lint exhaust duct system consisting of a complete access space (hole) through the wall or floor cavity with a cap or cover on the interior and exterior of the cavity which are secured in such a manner that they can be removed by the use of common household tools. The cap or cover in place shall limit air filtration and be designed to resist the entry of water or rodents into the home. The manufacturer is not required to provide the moisture-lint exhaust duct or the termination fitting;

(2) Install a receptacle for future connection of the dryer;

(3) Provide written instructions on how to complete the exhaust duct installation in accordance with the provisions of paragraphs (a)(1) through (5) of this section.

[42 FR 54383, Oct. 5, 1977. Redesignated at 44 FR 20679, Apr. 6, 1979, as amended at 58 FR 55018, Oct. 25, 1993]

§ 3280.709 Installation of appliances.

(a) The installation of each appliance shall conform to the terms of its listing and the manufacturer's instructions. The installer shall leave the manufacturer's instructions attached to the appliance. Every appliance shall be secured in place to avoid displacement. For the purpose of servicing and replacement, each appliance shall be both accessible and removable.

(b) Heat-producing appliances shall be so located that no doors, drapes, or other such material can be placed or swing closer to the front of the appliance than the clearances specified on the labeled appliances.

(c) Clearances surrounding heat producing appliances shall not be less than

the clearances specified in the terms of their listings.

(1) Prevention of storage. The area surrounding heat producing appliances installed in areas with interior or exterior access shall be framed-in or guarded with noncombustible material such that the distance from the appliance to the framing or guarding material is not greater than three inches unless the appliance is installed in compliance with paragraph (c)(2), of this section. When clearance required by the listing is greater than three inches, the guard or frame shall not be closer to the appliance than the distance provided in the listing.

(2) Clearance spaces surrounding heat producing appliances are not required to be framed-in or guarded when:

(i) A space is designed specifically for a clothes washer or dryer;

(ii) Dimensions surrounding the appliance do not exceed three inches; or

(iii) The manufacturer affixes either to a side of an alcove or compartment containing the appliance, or to the appliance itself, in a clearly visible location, a 3"×5" adhesive backed plastic laminated label or the equivalent which reads as follows:

"Warning"

This compartment is not to be used as a storage area. Storage of combustible materials or containers on or near any appliance in this compartment may create a fire hazard. Do not store such materials or containers in this compartment.

(d) All fuel-burning appliances, except ranges, ovens, illuminating appliances, clothes dryers, solid fuel-burning fireplaces and solid fuel-burning fireplace stoves, shall be installed to provide for the complete separation of the combustion system from the interior atmosphere of the manufactured home. Combustion air inlets and flue gas outlets shall be listed or certified as components of the appliance. The required separation may be obtained by:

(1) The installation of direct vent system (sealed combustion system) appliances, or

(2) The installation of appliances within enclosures so as to separate the appliance combustion system and venting system from the interior atmosphere of the manufactured home. There

§ 3280.709

24 CFR Ch. XX (4-1-11 Edition)

shall not be any door, removable access panel, or other opening into the enclosure from the inside of the manufactured home. Any opening for ducts, piping, wiring, etc., shall be sealed.

(e) A forced air appliance and its return-air system shall be designed and installed so that negative pressure created by the air-circulating fan cannot affect its or another appliance's combustion air supply or act to mix products of combustion with circulating air.

(1) The air circulating fan of a furnace installed in an enclosure with another fuel-burning appliance shall be operable only when any door or panel covering an opening in the furnace fan compartment or in a return air plenum or duct is in the closed position. This does not apply if both appliances are direct vent system (sealed combustion system) appliances.

(2) If a warm air appliance is installed within an enclosure to conform to §3280.709(d)(2), each warm-air outlet and each return air inlet shall extend to the exterior of the enclosure. Ducts, if used for that purpose, shall not have any opening within the enclosure and shall terminate at a location exterior to the enclosure.

(3) Cooling coils installed as a portion of, or in connection with, any forced-air furnace shall be installed on the downstream side unless the furnace is specifically otherwise listed.

(4) An air conditioner evaporator section shall not be located in the air discharge duct or plenum of any forced-air furnace unless the manufactured home manufacturer has complied with certification required in §3280.511.

(5) If a cooling coil is installed with a forced-air furnace, the coil shall be installed in accordance with its listing. When a furnace-coil unit has a limited listing, the installation must be in accordance with that listing.

(6) When an external heating appliance or combination cooling/heating appliance is to be field installed, the home manufacturer shall make provision for proper location of the connections to the supply and return air systems. The manufacturer is not required to provide said appliance(s). The preparation by the manufacturer for connection to the home's supply and return

air system shall include all fittings and connection ducts to the main duct and return air system such that the installer is only required to provide:

- (i) The appliance;
- (ii) Any appliance connections to the home; and
- (iii) The connecting duct between the external appliance and the fitting installed on the home by the manufacturer. The above connection preparations by the manufacturer do not apply to supply or return air systems designed only to accept external cooling (i.e., self contained air conditioning systems, etc.)

(7) The installation of a self contained air conditioner comfort cooling appliance shall meet the following requirements:

- (i) The installation on a duct common with an installed heating appliance shall require the installation of an automatic damper or other means to prevent the cooled air from passing through the heating appliance unless the heating appliance is certified or listed for such application and the supply system is intended for such an application.
- (ii) The installation shall prevent the flow of heated air into the external cooling appliance and its connecting ducts to the manufactured home supply and return air system during the operation of the heating appliance installed in the manufactured home.
- (iii) The installation shall prevent simultaneous operation of the heating and cooling appliances.

(f) *Vertical clearance above cooking top.* Ranges shall have a vertical clearance above the cooking top of not less than 24 inches. (See §3280.204).

(g) Solid fuel-burning factory-built fireplaces and fireplace stoves listed for use in manufactured homes may be installed in manufactured homes provided they and their installation conform to the following paragraphs. A fireplace or fireplace stove shall not be considered as a heating facility for determining compliance with subpart F.

(1) A solid fuel-burning fireplace or fireplace stove shall be equipped with integral door(s) or shutter(s) designed to close the fireplace or fireplace stove fire chamber opening and shall include complete means for venting through

the roof, a combustion air inlet, a hearth extension, and means to securely attach the fireplace or the fireplace stove to the manufactured home structure. The installation shall conform to the following paragraphs (g)(1) (i) to (vii) inclusive:

(i) A listed factory-built chimney designed to be attached directly to the fireplace or fireplace stove shall be used. The listed factory built chimney shall be equipped with and contain as part of its listing a termination device(s) and a spark arrester(s).

(ii) A fireplace or fireplace stove, air intake assembly, hearth extension and the chimney shall be installed in accordance with the terms of their listings and their manufacturer's instructions.

(iii) The combustion air inlet shall conduct the air directly into the fire chamber and shall be designed to prevent material from the hearth dropping onto the area beneath the manufactured home.

(iv) The fireplace or fireplace stove shall not be installed in a sleeping room.

(v) Hearth extension shall be of non-combustible material not less than 3/8-inch thick. The hearth shall extend at least 16 inches in front or and at least 8 inches beyond each side of the fireplace or fireplace stove opening. Furthermore the hearth shall extend over the entire surface beneath a fireplace stove and beneath an elevated or overhanging fireplace.

(vi) The label on each solid fuel-burning fireplace and solid fuel-burning fireplace stove shall include the following wording: For use with solid fuel only.

(vii) The chimney shall extend at least three feet above the part of the roof through which it passes and at least two feet above the highest elevation of any part of the manufactured home within 10 feet of the chimney. Portions of the chimney and termination that exceed an elevation of 13½ ft. above ground level may be designed to be removed for transporting the manufactured home.

(h) A corrosion resistant water drip collection and drain pan must be installed under each water heater that will allow water leaking from the

water heater to drain to the exterior of the manufactured home, or to a drain.

[40 FR 58752, Dec. 18, 1975. Redesignated at 44 FR 20679, Apr. 6, 1979, as amended at 44 FR 66195, Nov. 19, 1979; 58 FR 55018, Oct. 25, 1993; 70 FR 72050, Nov. 30, 2005]

§ 3280.710 Venting, ventilation and combustion air.

(a) The venting as required by § 3280.707(b) shall be accomplished by one or more of the methods given in (a)(1) and (2) of this section:

(1) An integral vent system listed or certified as part of the appliance.

(2) A venting system consisting entirely of listed components, including roof jack, installed in accordance with the terms of the appliance listing and the appliance manufacturer's instructions.

(b) Venting and combustion air systems shall be installed in accordance with the following:

(1) Components shall be securely assembled and properly aligned at the factory in accordance with the appliance manufacturer's instructions except vertical or horizontal sections of a fuel fired heating appliance venting system that extend beyond the roof line or outside the wall line may be installed at the site. Sectional venting systems shall be listed for such applications and installed in accordance with the terms of their listings and manufacturers' instructions. In cases where sections of the venting system are removed for transportation, a label shall be permanently attached to the appliance indicating the following:

Sections of the venting system have not been installed. Warning-do not operate the appliance until all sections have been assembled and installed in accordance with the manufacturer's instructions.

(2) Draft hood connectors shall be firmly attached to draft hood outlets or flue collars by sheet metal screws or by equivalent effective mechanical fasteners.

(3) Every joint of a vent, vent connector, exhaust duct and combustion air intake shall be secure and in alignment.

(c) Venting systems shall not terminate underneath a manufactured home.

(d) Venting system terminations shall be not less than three feet from

§ 3280.711

any motor-driven air intake discharging into habitable areas.

(e) The area in which cooking appliances are located shall be ventilated by a metal duct which may be single wall, not less than 12.5 square inches in cross-sectional area (minimum dimension shall be two inches) located above the appliance(s) and terminating outside the manufactured home, or by listed mechanical ventilating equipment discharging outside the home, that is installed in accordance with the terms of listing and the manufacturer's instructions. Gravity or mechanical ventilation shall be installed within a horizontal distance of not more than ten feet from the vertical front of the appliance(s).

(f) Mechanical ventilation which exhausts directly to the outside atmosphere from the living space of a home shall be equipped with an automatic or manual damper. Operating controls shall be provided such that mechanical ventilation can be separately operated without directly energizing other energy consuming devices.

[49 FR 32012, Aug. 9, 1984, as amended at 58 FR 55018, Oct. 25, 1993]

§ 3280.711 Instructions.

Operating instructions shall be provided with each appliance. These instructions shall include directions and information covering the proper use and efficient operation of the appliance and its proper maintenance.

§ 3280.712 Marking.

(a) Information on clearances, input rating, lighting and shutdown shall be attached to the appliances with the same permanence as the nameplate, and so located that it is easily readable when the appliance is properly installed or shutdown for transporting of manufactured home.

(b) Each fuel-burning appliance shall bear permanent marking designating the type(s) of fuel for which it is listed.

§ 3280.713 Accessibility.

Every appliance shall be accessible for inspection, service, repair, and replacement without removing permanent construction. For those purposes, inlet piping supplying the appliance shall not be considered permanent con-

24 CFR Ch. XX (4-1-11 Edition)

struction. Sufficient room shall be available to enable the operator to observe the burner, control, and ignition means while starting the appliance.

[58 FR 55018, Oct. 25, 1993]

§ 3280.714 Appliances, cooling.

(a) Every air conditioning unit or a combination air conditioning and heating unit shall be listed or certified by a nationally recognized testing agency for the application for which the unit is intended and installed in accordance with the terms of its listing.

(1) Mechanical air conditioners shall be rated in accordance with the ARI Standard 210/240-89 Unitary Air Conditioning and Air Source Unitary Heat Pump Equipment and certified by ARI or other nationally recognized testing agency capable of providing follow-up service.

(i) Electric motor-driven unitary cooling systems with rated capacity less than 65,000 BTU/Hr when rated at ARI Standard rating conditions in ARI Standard 210/240-89 Unitary Air-Conditioning and Air-Source Heat Pump Equipment, shall show energy efficiency (EER) values not less than 7.2.

(ii) Heat pumps shall be certified to comply with all the requirements of the ARI Standard 210/240-89 Unitary Air Conditioning and Air Source Unitary Heat Pump Equipment. Electric motor-driven vapor compression heat pumps with supplemental electrical resistance heat shall be sized to provide by compression at least 60 percent of the calculated annual heating requirements for the manufactured home being served. A control shall be provided and set to prevent operation of supplemental electrical resistance heat at outdoor temperatures above 40 F, except for defrost operation.

(iii) Electric motor-driven vapor compression heat pumps with supplemental electric resistance heat conforming to ARI Standard 210/240-89 Unitary Air-Conditioning and Air-Source Heat Pump Equipment shall show coefficient of performance ratios not less than shown below:

COP	
Temperature degrees fahrenheit	Coefficient of performance
47	2.5
17	1.7
0	1.0

(2) Gas fired absorption air conditioners must be listed or certified in accordance with ANSI Z21.40.1-1996, Gas Fired, Heat Activated, Air Conditioning and Heat Pump Appliances, and certified by a nationally recognized testing agency capable of providing follow-up service.

(3) Direct refrigerating systems serving any air conditioning or comfort-cooling system installed in a manufactured home shall employ a type of refrigerant that ranks no lower than Group 5 in the Underwriters' Laboratories, Inc. "Classification of Comparative Life Hazard of Various Chemicals."

(4) When a cooling or heat pump coil and air conditioner blower are installed with a furnace or heating appliance, they shall be tested and listed in combination for heating and safety performance by a nationally recognized testing agency.

(5) Cooling or heat pump indoor coils and outdoor sections shall be certified, listed and rated in combination for capacity and efficiency by a nationally recognized testing agency(ies). Rating procedures shall be based on U.S. Department of Energy test procedures.

(b) *Installation and instructions.* (1) The installation of each appliance shall conform to the terms of its listing as specified on the appliance and in the manufacturer's instructions. The installer shall include the manufacturer's installation instructions in the manufactured home. Appliances shall be secured in place to avoid displacement and movement from vibration and road shock.

(2) Operating instructions shall be provided with the appliance.

(c) Fuel-burning air conditioners shall also comply with § 280.707.

(d) The appliance rating plate shall be so located that it is easily readable when the appliance is properly installed.

(e) Every installed appliance shall be accessible for inspection, service, re-

pair and replacement without removing permanent construction.

[40 FR 58752, Dec. 18, 1975. Redesignated at 44 FR 20679, Apr. 6, 1979, as amended at 58 FR 55018, Oct. 25, 1993; 70 FR 72051, Nov. 30, 2005]

§ 3280.715 Circulating air systems.

(a) *Supply system.* (1) Supply ducts and any dampers contained therein shall be made from galvanized steel, tin-plated steel, or aluminum, or shall be listed Class 0, Class 1, or Class 2 air ducts. Class 2 air ducts shall be located at least 3 feet from the furnace bonnet or plenum. A duct system integral with the structure shall be of durable construction that can be demonstrated to be equally resistant to fire and deterioration. Ducts constructed from sheet metal shall be in accordance with the following table:

MINIMUM METAL THICKNESS FOR DUCTS ¹

Duct type	Diameter 14 in. or less	Width over 14 in.
Round	0.013	0.016
Enclosed rectangular013	.016
Exposed rectangular016	.019

¹When "nominal" thicknesses are specified, 0.003 in. shall be added to these "minimum" metal thicknesses.

(2) *Sizing of ducts for heating.* (i) Ducts shall be so designed that when a labeled forced-air furnace is installed and operated continuously at its normal heating air circulating rate in the manufactured home, with all registers in the full open position, the static pressure measured in the casing shall not exceed 90% of that shown on the label of the appliance. For upflow furnaces the static pressure shall be taken in the duct plenum. For external heating or combination heating/cooling appliances the static pressure shall be taken at the point used by the agency listing or certifying the appliance.

(ii) When an evaporator-coil specifically designed for the particular furnace is installed between the furnace and the duct plenum, the total static pressure shall be measured downstream of the coil in accordance with the appliance label and shall not exceed 90 percent of that shown on the label of the appliance.

(iii) When any other listed air-cooler coil is installed between the furnace and the duct plenum, the total static

§ 3280.715

24 CFR Ch. XX (4–1–11 Edition)

pressure shall be measured between the furnace and the coil and it shall not exceed 90 percent of that shown on the label of the furnace.

(iv) The minimum dimension of any branch duct shall be at least 1½ inches, and of any main duct, 2½ inches.

(3) *Sizing of ducts.* (i) The manufactured home manufacturer shall certify the capacity of the air cooling supply duct system for the maximum allowable output of ARI certified central air conditioning systems. The certification shall be at operating static pressure of 0.3 inches of water or greater. (See § 3280.511).

(ii) The refrigerated air cooling supply duct system including registers must be capable of handling at least 300 cfm per 10,000 btuh with a static pressure no greater than 0.3 inches of water when measured at room temperature. In the case of application of external self contained comfort cooling appliances or the cooling mode of combination heating/cooling appliances, either the external ducts between the appliance and the manufactured home supply system shall be considered part of, and shall comply with the requirements for the refrigerated air cooling supply duct system, or the connecting duct between the external appliance and the mobile supply duct system shall be a part of the listed appliance. The minimum dimension of any branch duct shall be at least 1½ inches, and of any main duct, 2½ inches.

(4) *Airtightness of supply duct systems.* A supply duct system shall be considered substantially airtight when the static pressure in the duct system, with all registers sealed and with the furnace air circulator at high speed, is at least 80 percent of the static pressure measured in the furnace casing, with its outlets sealed and the furnace air circulator operating at high speed. For the purpose of this paragraph and § 3280.715(b) pressures shall be measured with a water manometer or equivalent device calibrated to read in increments not greater than ¼₁₀ inch water column.

(5) *Expandable or multiple manufactured home connections.* (i) An expandable or multiple manufactured home may have ducts of the heating system installed in the various units. The points of connection must be so de-

signed and constructed that when the manufactured home is fully expanded or coupled, the resulting duct joint will conform to the requirements of this part.

(ii) Installation instructions for supporting the crossover duct from the manufactured home shall be provided for onsite installation. The duct shall not be in contact with the ground.

(6) Air supply ducts shall be insulated with material having an effective thermal resistance (R) of not less than 4.0 unless they are within manufactured home insulation having a minimum effective value of R-4.0 for floors or R-6.0 for ceilings.

(7) Supply and return ducts exposed directly to outside air, such as under chassis crossover ducts or ducts connecting external heating, cooling or combination heating/cooling appliances shall be insulated with material having a minimum thermal resistance of R=4.0, with a continuous vapor barrier having a perm rating of not more than 1 perm. Where exposed underneath the manufactured home, all such ducts shall comply with § 3280.715(a)(5)(ii).

(b) *Return air systems*—(1) *Return air openings.* Provisions shall be made to permit the return of circulating air from all rooms and living spaces, except toilet room(s), to the circulating air supply inlet of the furnace.

(2) *Duct material.* Return ducts and any diverting dampers contained therein shall be in accordance with the following:

(i) Portions of return ducts directly above the heating surfaces, or closer than 2 feet from the outer jacket or casing of the furnace shall be constructed of metal in accordance with § 3280.715(a)(1) or shall be listed Class 0 or Class 1 air ducts.

(ii) Return ducts, except as required by paragraph (a) of this section, shall be constructed of one-inch (nominal) wood boards (flame spread classification of not more than 200), other suitable material no more flammable than one-inch board or in accordance with § 3280.715(a)(1).

(iii) The interior of combustible ducts shall be lined with noncombustible material at points where there might be danger from incandescent

particles dropped through the register or furnace such as directly under floor registers and the bottom return.

(iv) Factory made air ducts used for connecting external heating, cooling or combination heating/cooling appliances to the supply system and return air system of a manufactured home shall be listed by a nationally recognized testing agency. Ducts applied to external heating appliances or combination heating/cooling appliances supply system outlets shall be constructed of metal in accordance with § 3280.715(a)(1) or shall be listed Class 0 or Class 1 air ducts for those portions of the duct closer than 2 feet from the outer casing of the appliance.

(v) Ducts applied to external appliances shall be resistant to deteriorating environmental effects, including but not limited to ultraviolet rays, cold weather, or moisture and shall be resistant to insects and rodents.

(3) *Sizing.* The cross-sectional areas of the return air duct shall not be less than 2 square inches for each 1,000 Btu per hour input rating of the appliance. Dampers shall not be placed in a combination fresh air intake and return air duct so arranged that the required cross-sectional area will not be reduced at all possible positions of the damper.

(4) *Permanent uncloseable openings.* Living areas not served by return air ducts or closed off from the return opening of the furnace by doors, sliding partitions, or other means shall be provided with permanent uncloseable openings in the doors or separating partitions to allow circulated air to return to the furnace. Such openings may be grilled or louvered. The net free area of each opening shall be not less than 1 square inch for every 5 square feet of total living area closed off from the furnace by the door or partition serviced by that opening. Undercutting doors connecting the closed-off space may be used as a means of providing return air area. However, in the event that doors are undercut, they shall be undercut a minimum of 2 inches and not more than 2½ inches, as measured from the top surface of the floor decking to the bottom of the door and no more than one half of the free air area so provided shall be counted as return air area.

(c) *Joints and seams.* Joints and seams of sheet metal and factory-made flexible ducts, including trunks, branches, risers, crossover ducts, and crossover duct plenums, shall be mechanically secured and made substantially airtight. Slip joints in sheet metal ducts shall have a lap of at least one inch and shall be mechanically fastened. Tapes or caulking compounds shall be permitted to be used for sealing mechanically secure joints. Sealants and tapes shall be applied only to surfaces that are dry and dust-, dirt-, oil-, and grease-free. Tapes and mastic closure systems for use with factory-made rigid fiberglass air ducts and air connectors shall be listed in accordance with UL Standard 181A-1994, with 1998 revisions. Tapes and mastic closure systems used with factory-made flexible air ducts and air connectors shall be listed in accordance with UL Standard 181B-1995, with 1998 revisions.

(d) *Supports.* Ducts shall be securely supported.

(e) *Registers and grilles.* Fittings connecting the registers and grilles to the duct system must be constructed of metal or material that complies with the requirements of Class 1 or 2 ducts under UL 181-1996 with 1998 revisions, Factory Made Air Ducts and Connectors. Air supply terminal devices (registers) when installed in kitchen, bedrooms, and bathrooms must be equipped with adjustable closeable dampers. Registers or grilles must be constructed of metal or conform with the following:

(1) Be made of a material classified 94V-0 or 94V-1, when tested as described in UL 94-1996, with 2001 revisions, Test for Flammability of Plastic Materials for Parts in Devices and Appliances, Fifth Edition; and

(2) Floor registers or grilles shall resist without structural failure a 200 lb. concentrated load on a 2-inch diameter disc applied to the most critical area of the exposed face of the register or grille. For this test the register or grille is to be at a temperature of not less than 165 °F and is to be supported

§ 3280.801

in accordance with the manufacturer's instructions.

[40 FR 58752, Dec. 18, 1975. Redesignated at 44 FR 20679, Apr. 6, 1979, as amended at 52 FR 4589, Feb. 12, 1987; 58 FR 55019, Oct. 25, 1993; 70 FR 72051, Nov. 30, 2005]

Subpart I—Electrical Systems

§ 3280.801 Scope.

(a) Subpart I of this part and Part II of Article 550 of the National Electrical Code (NFPA No. 70-2005) cover the electrical conductors and equipment installed within or on manufactured homes and the conductors that connect manufactured homes to a supply of electricity.

(b) In addition to the requirements of this part and Part II of Article 550 of the National Electrical Code (NFPA No. 70-2005), the applicable portions of other Articles of the National Electrical Code must be followed for electrical installations in manufactured homes. The use of arc-fault breakers under Articles 210.12(A) and (B), 440.65, and 550.25(A) and (B) of the National Electrical Code, NFPA No. 70-2005 is not required. However, if arc-fault breakers are provided, such use must be in accordance with the National Electrical Code, NFPA No. 70-2005. Wherever the requirements of this standard differ from the National Electrical Code, these standards apply.

(c) The provisions of this standard apply to manufactured homes intended for connection to a wiring system nominally rated 120/240 volts, 3-wire AC, with grounded neutral.

(d) All electrical materials, devices, appliances, fittings and other equipment shall be listed or labeled by a nationally recognized testing agency and shall be connected in an approved manner when in service.

(e) Aluminum conductors, aluminum alloy conductors, and aluminum core conductors such as copper clad aluminum; are not acceptable for use in branch circuit wiring in manufactured homes.

[40 FR 58752, Dec. 18, 1975. Redesignated at 44 FR 20679, Apr. 6, 1979, as amended at 58 FR 55019, Oct. 25, 1993; 70 FR 72051, Nov. 30, 2005; 71 FR 19639, Apr. 17, 2006]

24 CFR Ch. XX (4-1-11 Edition)

§ 3280.802 Definitions.

(a) The following definitions are applicable to subpart I only.

(1) *Accessible* (i) (*As applied to equipment*) means admitting close approach because not guarded by locked doors, elevation, or other effective means. (See *readily accessible*.)

(ii) (*As applied to wiring methods*) means capable of being removed or exposed without damaging the manufactured home structure or finish, or not permanently closed-in by the structure or finish of the manufactured home (see *concealed* and *exposed*).

(2) *Air conditioning or comfort cooling equipment* means all of that equipment intended or installed for the purpose of processing the treatment of air so as to control simultaneously its temperature, humidity, cleanliness, and distribution to meet the requirements of the conditioned space.

(3)(i) *Appliance* means utilization equipment, generally other than industrial, normally built in standardized sizes or types, which is installed or connected as a unit to perform one or more functions, such as clothes washing, air conditioning, food mixing, deep frying, etc.

(ii) *Appliance, fixed* means an appliance which is fastened or otherwise secured at a specific location.

(iii) *Appliance, portable* means an appliance which is actually moved or can easily be moved from one place to another in normal use. For the purpose of this Standard, the following major appliances are considered portable if cord-connected: refrigerators, clothes washers, dishwashers without booster heaters, or other similar appliances.

(iv) *Appliance, stationary* means an appliance which is not easily moved from one place to another in normal use.

(4) *Attachment plug (plug cap) (cap)* means a device which, by insertion in a receptacle, establishes connection between the conductors of the attached flexible cord and the conductors connected permanently to the receptacle.

(5) *Bonding* means the permanent joining of metallic parts to form an electrically conductive path which will assure electrical continuity and the capacity to conduct safely any current likely to be imposed.

(6) *Branch circuit* (i) means the circuit conductors between the final overcurrent device protecting the circuit and the outlet(s). A device not approved for branch circuit protection, such as a thermal cutout or motor overload protective device, is not considered as the overcurrent device protecting the circuit.

(ii) *Branch circuit—appliance* means a branch circuit supplying energy to one or more outlets to which appliances are to be connected, such circuits to have no permanently connected lighting fixtures not a part of an appliance.

(iii) *Branch circuit—general purpose* means a circuit that supplies a number of outlets for lighting and appliances.

(iv) *Branch circuit—individual* means a branch circuit that supplies only one utilization equipment.

(7) *Cabinet* means an enclosure designed either for surface or flush mounting, and provided with a frame, mat, or trim in which swinging doors are hung.

(8) *Circuit breaker* means a device designed to open and close a circuit by nonautomatic means, and to open the circuit automatically on a predetermined overload of current without injury to itself when properly applied within its rating.

(9) *Concealed* means rendered inaccessible by the structure or finish of the manufactured home. Wires in concealed raceways are considered concealed, even though they may become accessible by withdrawing them. (See *accessible (As applied to wiring methods)*)

(10) *Connector, pressure (solderless)* means a device that establishes a connection between two or more conductors or between one or more conductors and a terminal by means of mechanical pressure and without the use of solder.

(11) *Dead front (as applied to switches, circuit-breakers, switchboards, and distribution panelboard)* means so designed, constructed, and installed that no current-carrying parts are normally exposed on the front.

(12) *Demand factor* means the ratio of the maximum demand of a system, or part of a system, to the total connected load of a system or the part of the system under consideration.

(13) *Device* means a unit of an electrical system that is intended to carry but not utilize electrical energy.

(14) *Disconnecting means* means a device, or group of devices, or other means by which the conductors of a circuit can be disconnected from their source of supply.

(15) *Distribution panelboard* means a single panel or a group of panel units designed for assembly in the form of a single panel, including buses, and with or without switches or automatic overcurrent protective devices or both, for the control of light, heat, or power circuits of small individual as well as aggregate capacity; designed to be placed in a cabinet placed in or against a wall or partition and accessible only from the front.

(16) *Enclosed* means surrounded by a case that will prevent a person from accidentally contacting live parts.

(17) *Equipment* means a general term, including material, fittings, devices, appliances, fixtures, apparatus, and the like used as a part of, or in connection with, an electrical installation.

(18) *Exposed* (i) (As applied to live parts) means capable of being inadvertently touched or approached nearer than a safe distance by a person. It is applied to parts not suitably guarded, isolated, or insulated. (See *accessible and concealed*.)

(ii) (As applied to *wiring method*) means on or attached to the surface or behind panels designed to allow access. (See *Accessible (as applied to wiring methods)*)

(19) *Externally operable* means capable of being operated without exposing the operator to contact with live parts.

(20) *Feeder assembly* means the overhead or under-chassis feeder conductors, including the grounding conductor, together with the necessary fittings and equipment, or a power supply cord approved for manufactured home use, designed for the purpose of delivering energy from the source of electrical supply to the distribution panelboard within the manufactured home.

(21) *Fitting* means an accessory, such as a locknut, bushing, or other part of a wiring system, that is intended primarily to perform a mechanical rather than an electrical function.

(22) *Ground* means a conducting connection, whether intentional or accidental, between an electrical circuit or equipment and earth, or to some conducting body that serves in place of the earth.

(23) *Grounded* means connected to earth or to some conducting body that serves in place of the earth.

(24) *Grounded conductor* means a system or circuit conductor that is intentionally grounded.

(25) *Grounding conductor* means a conductor used to connect equipment or the grounded circuit of a wiring system to a grounding electrode or electrodes.

(26) *Guarded* means covered, shielded, fenced, enclosed, or otherwise protected by means of suitable covers, casings, barriers, rails, screens, mats or platforms to remove the likelihood of approach or contact by persons or objects to a point of danger.

(27) *Isolated* means not readily accessible to persons unless special means for access are used.

(28) *Laundry area* means an area containing or designed to contain either a laundry tray, clothes washer and/or clothes dryer.

(29) *Lighting outlet* means an outlet intended for the direct connection of a lampholder, a lighting fixture, or a pendant cord terminating in a lampholder.

(30) *Manufactured home accessory building or structure* means any awning, cabana, ramada, storage cabinet, carport, fence, windbreak or porch established for the use of the occupant of the manufactured home upon a manufactured home lot.

(31) *Manufactured home service equipment* means the equipment containing the disconnecting means, overcurrent protective devices, and receptacles or other means for connecting a manufactured home feeder assembly.

(32) *Outlet* means a point on the wiring system at which current is taken to supply utilization equipment.

(33) *Panelboard* means a single panel or group of panel units designed for assembly in the form of a single panel; including buses, automatic overcurrent protective devices, and with or without switches for the control of light, heat, or power circuits; designed to be placed in a cabinet or cutout box placed in or

against a wall or partition and accessible only from the front.

(34) *Raceway* means any channel for holding wires, cables, or busbars that is designed expressly for, and used solely for, this purpose. Raceways may be of metal or insulating material, and the term includes rigid metal conduit, rigid nonmetallic conduit, flexible metal conduit, electrical metallic tubing, underfloor raceways, cellular concrete floor raceways, cellular metal floor raceways, surface raceways, structural raceways, wireways, and busways.

(35) *Raintight* means so constructed or protected that exposure to a beating rain will not result in the entrance of water.

(36) *Readily accessible* means capable of being reached quickly for operation, renewal, or inspection, without requiring those to whom ready access is requisite to climb over or remove obstacles or to resort to portable ladders, chairs, etc. (See *Accessible*.)

(37) *Receptacle* means a contact device installed at an outlet for the connection of a single attachment plug. A single receptacle is a single contact device with no other contact device on the same yoke. A multiple receptacle is a single device containing two or more receptacles.

(38) *Receptacle outlet* means an outlet where one or more receptacles are installed.

(39) *Utilization equipment* means equipment which utilizes electric energy for mechanical, chemical, heating, lighting, or similar purposes.

(40) *Voltage (of a circuit)* means the greatest root-mean-square (effective) difference of potential between any two conductors of the circuit concerned. Some systems, such as 3-phase 4-wire, single-phase 3-wire, and 3-wire direct-current may have various circuits of various voltages.

(41) *Weatherproof* means so constructed or protected that exposure to the weather will not interfere with successful operation. Rainproof, raintight, or watertight equipment can fulfill the requirements for weatherproof where varying weather conditions other than wetness, such as snow, ice, dust, or temperature extremes, are not a factor.

§ 3280.803 Power supply.

(a) The power supply to the manufactured home shall be a feeder assembly consisting of not more than one listed 50 ampere manufactured home power-supply cords, or a permanently installed circuit. A manufactured home that is factory-equipped with gas or oil-fired central heating equipment and cooking appliances shall be permitted to be provided with a listed manufactured home power-supply cord rated 40 amperes.

(b) If the manufactured home has a power-supply cord, it shall be permanently attached to the distribution panelboard or to a junction box permanently connected to the distribution panelboard, with the free end terminating in an attachment plug cap.

(c) Cords with adapters and pigtail ends, extension cords, and similar items shall not be attached to, or shipped with, a manufactured home.

(d) A listed clamp or the equivalent shall be provided at the distribution panelboard knockout to afford strain relief for the cord to prevent strain from being transmitted to the terminals when the power-supply cord is handled in its intended manner.

(e) The cord shall be of an approved type with four conductors, one of which shall be identified by a continuous green color or a continuous green color with one or more yellow stripes for use as the grounding conductor.

(f) The attachment plug cap shall be a 3-pole, 4-wire grounding type, rated 50 amperes, 125/250 volts with a configuration as shown herein and intended for use with the 50-ampere, 125/250 receptacle configuration shown. It shall be molded of butyl rubber, neoprene, or other approved materials which have been found suitable for the purpose, and shall be molded to the flexible cord so that it adheres tightly to the cord at the point where the cord enters the attachment-plug cap. If a right-angle cap is used, the configuration shall be so oriented that the grounding member is farthest from the cord.

Receptacle*Cap*

50-ampere 125/250 volt receptacle and attachment-plug-cap configurations, 3 pole, 4-wire grounding types used for manufactured home supply cords and manufactured home parks. Complete details of the 50-ampere cap and receptacle can be found in the American National Standard Dimensions of Caps, Plugs, and Receptacles, Grounding Type (ANSI/NEMA—WD-6-1997—Wiring Devices—Dimensional Specifications).

(g) The overall length of a power-supply cord, measured from the end of the cord, including bared leads, to the face of the attachment-plug cap shall not be less than 21 feet and shall not exceed 36½ feet. The length of cord from the face of the attachment-plug cap to the point where the cord enters the manufactured home shall not be less than 20 feet.

(h) The power supply cord shall bear the following marking: "For use with manufactured homes—40 amperes" or "For use with manufactured homes—50 amperes."

(i) Where the cord passes through walls or floors, it shall be protected by means of conduit and bushings or equivalent. The cord may be installed within the manufactured home walls, provided a continuous raceway is installed from the branch-circuit panelboard to the underside of the manufactured home floor. The raceway may be rigid conduit, electrical metallic tubing or polyethylene (PE), polyvinylchloride (PVC) or acrylonitrile-butadiene-styrene (ABS) plastic tubing having a minimum wall thickness of nominal ¼ inch.

(j) Permanent provisions shall be made for the protection of the attachment-plug cap of the power supply cord and any connector cord assembly or receptacle against corrosion and mechanical damage if such devices are in an exterior location while the manufactured home is in transit.

(k) Where the calculated load exceeds 50 amperes or where a permanent feeder is used, the supply shall be by means of:

§ 3280.804

24 CFR Ch. XX (4-1-11 Edition)

(1) One mast weatherhead installation installed in accordance with Article 230 of the National Electrical Code, NFPA No. 70-2005, containing four continuous insulated, color-coded, feeder conductors, one of which shall be an equipment grounding conductor; or

(2) An approved raceway from the disconnecting means in the manufactured home to the underside of the manufactured home with provisions for the attachment of a suitable junction box or fitting to the raceway on the underside of the manufactured home. The manufacturer shall provide in his written installation instructions, the proper feeder conductor sizes for the raceway and the size of the junction box to be used; or

(3) Service equipment installed on the manufactured home in accordance with Article 230 of the National Electrical Code, NFPA No. 70-2005, and the following requirements:

(i) The installation shall be completed by the manufacturer except for the service connections, the meter and the grounding electrode conductor;

(ii) Exterior equipment, or the enclosure in which it is installed must be weatherproof and installed in accordance with Article 312.2(A) of the National Electrical Code, NFPA No. 70-2005, and conductors must be suitable for use in wet locations;

(iii) Each neutral conductor must be connected to the system grounding conductor on the supply side of the main disconnect in accordance with Articles 250.24, 250.26, and 250.28 of the National Electrical Code, NFPA No. 70-2005.

(iv) The manufacturer shall include in its written installation instructions one method of grounding the service equipment at the installation site;

(v) The minimum size grounding electrode conductor shall be specified in the instructions; and

(vi) A red "Warning" label shall be mounted on or adjacent to the service equipment. The label shall state:

"Warning—do not provide electrical power until the grounding electrode is installed and connected (see installation instructions)."

[40 FR 58752, Dec. 18, 1975. Redesignated at 44 FR 20679, Apr. 6, 1979, as amended at 52 FR 4589, Feb. 12, 1987; 58 FR 55019, Oct. 25, 1993; 70 FR 72051, Nov. 30, 2005]

§ 3280.804 Disconnecting means and branch-circuit protective equipment.

(a) The branch-circuit equipment is permitted to be combined with the disconnecting means as a single assembly. Such a combination is permitted to be designated as a distribution panelboard. If a fused distribution panelboard is used, the maximum fuse size of the mains must be plainly marked with lettering at least ¼-inch high and that is visible when fuses are changed. (See Article 110.22 of NFPA 70-2005, National Electrical Code, concerning identification of each disconnecting means and each service, feeder, or branch circuit at the point where it originated and the type marking needed.)

(b) Plug fuses and fuseholders shall be tamper-resistant, Type "S," enclosed in dead-front fuse panelboards. Electrical distribution panels containing circuit breakers shall also be dead-front type.

(c) Disconnecting means. A single disconnecting means shall be provided in each manufactured home consisting of a circuit breaker, or a switch and fuses and their accessories installed in a readily accessible location near the point of entrance of the supply cord or conductors into the manufactured home. The main circuit breakers or fuses shall be plainly marked "Main." This equipment shall contain a solderless type of grounding connector or bar for the purposes of grounding with sufficient terminals for all grounding conductors. The neutral bar termination of the grounded circuit conductors shall be insulated.

(d) The disconnecting equipment shall have a rating suitable for the connected load. The distribution equipment, either circuit breaker or fused type, shall be located a minimum of 24 inches from the bottom of such equipment to the floor level of the manufactured home.

(e) A distribution panelboard employing a main circuit breaker shall be rated 50 amperes and employ a 2-pole circuit breaker rated 40 amperes for a 40-ampere supply cord, or 50 amperes for a 50-ampere supply cord. A distribution panelboard employing a disconnect switch and fuses shall be rated 60 amperes and shall employ a single 2-

pole, 60-ampere fuseholder with 40- or 50-ampere main fuses for 40- or 50-ampere supply cords, respectively. The outside of the distribution panelboard shall be plainly marked with the fuse size.

(f) The distribution panelboard shall not be located in a bathroom, or in any other inaccessible location, but shall be permitted just inside a closet entry if the location is such that a clear space of 6 inches to easily ignitable materials is maintained in front of the distribution panelboard, and the distribution panelboard door can be extended to its full open position (at least 90 degrees). A clear working space at least 30 inches wide and 30 inches in front of the distribution panelboard shall be provided. This space shall extend from floor to the top of the distribution panelboard.

(g) Branch-circuit distribution equipment shall be installed in each manufactured home and shall include overcurrent protection for each branch circuit consisting of either circuit breakers or fuses.

(1) The branch circuit overcurrent devices shall be rated:

(i) Not more than the circuit conductors; and

(ii) Not more than 150 percent of the rating of a single appliance rated 13.3 amperes or more which is supplied by an individual branch circuit; but

(iii) Not more than the fuse size marked on the air conditioner or other motor-operated appliance.

(h) A 15-ampere multiple receptacle shall be acceptable when connected to a 20-ampere laundry circuit.

(i) When circuit breakers are provided for branch-circuit protection 240 circuits shall be protected by 2-pole common or companion trip, or handle-tied paired circuit breakers.

(j) A 3 inch by 1-3/4 inch minimum size tag made of etched, metal-stamped or embossed brass, stainless steel, anodized or alclad aluminum not less than 0.020 inch thick, or other approval material (e.g., 0.005 inch plastic laminates) shall be permanently affixed on the outside adjacent to the feeder assembly entrance and shall read: This connection for 120/240 Volt, 3-Pole, 4-Wire, 60 Hertz, _____ Ampere Supply.

The correct ampere rating shall be marked on the blank space.

(k) When a home is provided with installed service equipment, a single disconnecting means for disconnecting the branch circuit conductors from the service entrance conductors must be provided in accordance with Article 230, Part VI of the National Electrical Code, NFPA No. 70-2005. The disconnecting means shall be listed for use as service equipment. The disconnecting means may be combined with the disconnect required by § 3280.804(c). The disconnecting means shall be rated not more than the ampere supply or service capacity indicated on the tag required by paragraph (l) of this section.

(1) When a home is provided with installed service equipment, the electrical nameplate required by § 3280.804(j) shall read: "This connection for 120/240 volt, 3 pole, 3 wire, 60 Hertz, _____ Ampere Supply." The correct ampere rating shall be marked in the blank space.

[40 FR 58752, Dec. 18, 1975, as amended at 42 FR 961, Jan. 4, 1977. Redesignated at 44 FR 20679, Apr. 6, 1979, as amended at 52 FR 4589, Feb. 12, 1987; 58 FR 55019, Oct. 25, 1993; 70 FR 72051, Nov. 30, 2005]

§ 3280.805 Branch circuits required.

(a) The number of branch circuits required shall be determined in accordance with the following:

(1) Lighting, based on 3 volt-amperes per square foot times outside dimensions of the manufactured home (coupler excluded) divided by 120 volts times amperes to determine number of 15 or 20 ampere lighting area circuits. e.g. $[3 \times \text{length} \times \text{width} - [120 \times (15 \text{ or } 20)] = \text{number of 15 or 20 ampere circuits.}$

(2) *Small appliances.* For the small appliance load in kitchen, pantry dining room and breakfast rooms of manufactured homes, two or more 20-ampere appliance branch circuits, in addition to the branch circuit specified in § 3280.805(a)(1), shall be provided for all receptacle outlets in these rooms, and such circuits shall have no other outlets. Receptacle outlets supplied by at least two appliance receptacle branch circuits shall be installed in the kitchen.

§ 3280.806

24 CFR Ch. XX (4-1-11 Edition)

(3) *General appliances (Including furnace, water heater, range, and central or room air conditioner, etc.).* There shall be one or more circuits of adequate rating in accordance with the following:

(i) Ampere rating of fixed appliances not over 50 percent of circuit rating if lighting outlets (receptacles, other than kitchen, dining area, and laundry, considered as lighting outlets) are on same circuit;

(ii) For fixed appliances on a circuit without lighting outlets, the sum of rated amperes shall not exceed the branch-circuit rating. Motor loads or other continuous duty loads shall not exceed 80 percent of the branch circuit rating.

(iii) The rating of a single cord and plug connected appliances on a circuit having no other outlets, shall not exceed 80 percent of the circuit rating.

(iv) The rating of the range branch circuit is based on the range demand as specified for ranges in §3280.811(a)(5). For central air conditioning, see Article 440 of the National Electrical Code, NFPA No. 70-2005.

(v) Where a laundry area is provided, a 20 ampere branch circuit shall be provided to supply laundry receptacle outlets. This circuit shall have no other outlets. See §3280.806(a)(7).

(b) [Reserved]

[40 FR 58752, Dec. 18, 1975. Redesignated at 44 FR 20679, Apr. 6, 1979, as amended at 58 FR 55020, Oct. 25, 1993; 70 FR 72051, Nov. 30, 2005]

§ 3280.806 Receptacle outlets.

(a) All receptacle outlets shall be:

(1) Of grounding type;

(2) Installed according to Article 406.3 of the National Electrical Code, NFPA No. 70-2005.

(3) Except when supplying specific appliances, be parallel-blade, 15-ampere, 125-volt, either single or duplex.

(b) All 120 volt single phase, 15 and 20 ampere receptacle outlets, including receptacles in light fixtures, installed outdoors, in compartments accessible from the outdoors, in bathrooms, and within 6 feet of a kitchen sink to serve counter top surfaces shall have ground-fault circuit protection for personnel. Feeders supplying branch circuits may be protected by a ground-fault circuit-interrupter in lieu of the provision for such interrupters specified above. Re-

ceptacles dedicated for washer and dryers, also located in a bathroom, are exempt from this requirement.

(c) There shall be an outlet of the grounding type for each cord-connected fixed appliance installed.

(d) Receptacle outlets required. Except in the bath and hall areas, receptacle outlets shall be installed at wall spaces 2 feet wide or more, so that no point along the floor line is more than 6 feet, measured horizontally, from an outlet in that space. In addition, a receptacle outlet shall be installed:

(1) Over or adjacent to counter tops in the kitchen (at least one on each side of the sink if counter tops are on each side and 12 inches or over in width).

(2) Adjacent to the refrigerator and free-standing gas-range space. A duplex receptacle may serve as the outlet for a countertop and a refrigerator.

(3) At counter top spaces for built-in vanities.

(4) At counter top spaces under wall-mounted cabinets.

(5) In the wall, at the nearest point where a bar type counter attaches to the wall.

(6) In the wall at the nearest point where a fixed room divider attaches to the wall.

(7) In laundry areas within 6 feet of the intended location of the appliance(s).

(8) At least one receptacle outlet shall be installed outdoors.

(9) At least one wall receptacle outlet shall be installed in bathrooms within 36 inches (914 mm) of the outside edge of each basin. The receptacle outlet must be located on a wall that is adjacent to the basin location. This receptacle is in addition to any receptacle that is part of a lighting fixture or appliance. The receptacle must not be enclosed within a bathroom cabinet or vanity.

(10) Receptacle outlets are not required in the following locations:

(i) Wall space occupied by built-in kitchen or wardrobe cabinets,

(ii) Wall space behind doors which may be opened fully against a wall surface,

(iii) Room dividers of the lattice type, less than 8 feet long, not solid within 6 inches of the floor,

(iv) Wall space afforded by bar type counters.

(e) Receptacle outlets shall not be installed in or within reach (30 inches) of a shower or bathtub space.

(f) Receptacle outlets shall not be installed above electric baseboard heaters.

[40 FR 58752, Dec. 18, 1975. Redesignated at 44 FR 20679, Apr. 6, 1979, as amended at 58 FR 55020, Oct. 25, 1993; 70 FR 72052, Nov. 30, 2005]

§ 3280.807 Fixtures and appliances.

(a) Electrical materials, devices, appliances, fittings, and other equipment installed, intended for use in, or attached to the manufactured home shall be approved for the application and shall be connected in an approved manner when in service. Facilities shall be provided to securely fasten appliances when the manufactured home is in transit. (See § 3280.809.)

(b) Specifically listed pendant-type fixtures or pendant cords shall be permitted in manufactured homes.

(c) If a lighting fixture is provided over a bathtub or in a shower stall, it must be of the enclosed and gasketed type, and be listed for use in wet locations. See also Article 410.4(D) of the National Electrical Code, NFPA No. 70-2005.

(d) The switch for shower lighting fixtures and exhaust fans located over a tub or in a shower stall shall be located outside the tub shower space. (See § 3280.806(e).)

(e) Any combustible wall or ceiling finish exposed between the edge of a fixture canopy, or pan and an outlet box shall be covered with non-combustible or limited combustible material.

(f) Every appliance shall be accessible for inspection, service, repair, or replacement without removal of permanent construction.

[40 FR 58752, Dec. 18, 1975. Redesignated at 44 FR 20679, Apr. 6, 1979, as amended at 52 FR 35543, Sept. 22, 1987; 58 FR 55020, Oct. 25, 1993; 70 FR 72052, Nov. 30, 2005]

§ 3280.808 Wiring methods and materials.

(a) Except as specifically permitted by this part, the wiring methods and materials specified in the National Electrical Code, NFPA No. 70-2005, must be used in manufactured homes.

(b) Nonmetallic outlet boxes shall be acceptable only with nonmetallic cable.

(c) Nonmetallic cable located 15 inches or less above the floor, if exposed, shall be protected from physical damage by covering boards, guard strips, or conduit. Cable likely to be damaged by stowage shall be so protected in all cases.

(d) Nonmetallic sheathed cable shall be secured by staples, straps, or similar fittings so designed and installed as not to injure any cable. Cable shall be secured in place at intervals not exceeding 4½ feet and within 12 inches from every cabinet, box or fitting.

(e) Metal-clad and nonmetallic cables shall be permitted to pass through the centers of the wide side of 2-inch by 4-inch studs. However, they shall be protected where they pass through 2-inch by 2-inch studs or at other studs or frames where the cable or armor would be less than 1½ inches from the inside or outside surface of the studs when the wall covering materials are in contact with the studs. Steel plates on each side of the cable, or a tube, with not less than No. 16 MSG wall thickness shall be required to protect the cable. These plates or tubes shall be securely held in place.

(f) Where metallic faceplates are used they shall be effectively grounded.

(g) If the range, clothes dryer, or similar appliance is connected by metalclad cable or flexible conduit, a length of not less than three feet of free cable or conduit shall be provided to permit moving the appliance. Type NM or Type SE cable shall not be used to connect a range or a dryer. This shall not prohibit the use of Type NM or Type SE cable between the branch circuit overcurrent protective device and a junction box or range or dryer receptacle.

(h) Threaded rigid metal conduit shall be provided with a locknut inside and outside the box, and a conduit bushing shall be used on the inside. Rigid nonmetallic conduit shall be permitted. Inside ends of the conduit shall be reamed.

(i) Switches shall be rated as follows:

§ 3280.809

24 CFR Ch. XX (4–1–11 Edition)

(1) For lighting circuits, switches, shall have a 10-ampere, 120–125 volt rating; or higher if needed for the connected load.

(2) For motors or other loads, switches shall have ampere or horsepower ratings, or both, adequate for loads controlled. (An “AC general-use” snap switch shall be permitted to control a motor 2 horsepower or less with full-load current not over 80 percent of the switch ampere rating).

(j) At least 4 inches of free conductor shall be left at each outlet box except where conductors are intended to loop without joints.

(k) When outdoor or under-chassis line-voltage wiring is exposed to moisture or physical damage, it shall be protected by rigid metal conduit. The conductors shall be suitable for wet locations. Electrical metallic tubing may be used when closely routed against frames, and equipment enclosures.

(l) The cables or conductors shall be Type NMC, TW, or equivalent.

(m) Outlet boxes of dimensions less than those required in Table 314.16(A) of the National Electrical Code, NFPA No. 70–2005, are permitted provided the box has been tested and approved for that purpose.

(n) Boxes, fittings, and cabinets shall be securely fastened in place, and shall be supported from a structural member of the home, either directly or by using a substantial brace. Snap-in type boxes provided with special wall or ceiling brackets that securely fasten boxes in walls or ceilings shall be permitted.

(o) Outlet boxes must fit closely to openings in combustible walls and ceilings and must be flush with the finish surface or project therefrom. In walls and ceilings of noncombustible material, outlet boxes and fittings must be installed so that the front edge of the box or fitting will not be set back from the finished surface more than ¼ inch. Plaster, drywall, or plasterboard surfaces that are broken or incomplete must be repaired so that there will be no gaps or open spaces greater than ⅛ inch at the edge of the box or fitting.

(p) Appliances having branch-circuit terminal connections which operate at temperatures higher than 60 °C (140 °F) shall have circuit conductors as de-

scribed in paragraphs (p) (1) and (2) of this section:

(1) Branch-circuit conductors having an insulation suitable for the temperature encountered shall be permitted to run directly to the appliance.

(2) Conductors having an insulation suitable for the temperature encountered shall be run from the appliance terminal connections to a readily accessible outlet box placed at least one foot from the appliance. These conductors shall be in a suitable raceway which shall extend for at least 4 feet.

(q) A substantial brace for securing a box, fitting, or cabinet must be as described in the National Electrical Code, NFPA 70–2005, Article 314.23(B), or the brace, including the fastening mechanism to attach the brace to the home structure, must withstand a force of 50 lbs. applied to the brace at the intended point(s) of attachment for the box in a direction perpendicular to the surface on which the box is installed.

(r) Where the sheathing of NM cable has been cut or damaged and visual inspection reveals that the conductor and its insulation has not been damaged, it shall be permitted to repair the cable sheath with electrical tape which provides equivalent protection to the sheath.

[40 FR 58752, Dec. 18, 1975. Redesignated at 44 FR 20679, Apr. 6, 1979, as amended at 58 FR 55020, Oct. 25, 1993; 70 FR 72052, Nov. 30, 2005]

§ 3280.809 **Grounding.**

(a) *General.* Grounding of both electrical and nonelectrical metal parts in a manufactured home shall be through connection to a grounding bus in the manufactured home distribution panelboard. The grounding bus shall be grounded through the green-colored conductor in the supply cord or the feeder wiring to the service ground in the service-entrance equipment located adjacent to the manufactured home location. Neither the frame of the manufactured home nor the frame of any appliance shall be connected to the neutral conductor in the manufactured home.

(b) *Insulated neutral.* (1) The grounded circuit conductor (neutral) shall be insulated from the grounding conductors and from equipment enclosures and other grounded parts. The grounded

(neutral) circuit terminals in the distribution panelboard and in ranges, clothes dryers, counter-mounted cooking units, and wall-mounted ovens shall be insulated from the equipment enclosure. Bonding screws, straps, or buses in the distribution panelboard or in appliances shall be removed and discarded. However, when service equipment is installed on the manufactured home, the neutral and the ground bus may be connected in the distribution panel.

(2) Connection of ranges and clothes dryers with 120/240 volt, 3-wire ratings shall be made with 4 conductor cord and 3 pole, 4-wire grounding type plugs, or by type AC metal clad conductors enclosed in flexible metal conduit. For 120 volt rated devices a 3-conductor cord and a 2-pole, 3-wire grounding type plug shall be permitted.

(c) *Equipment grounding means.* (1) The green-colored grounding wire in the supply cord or permanent feeder wiring shall be connected to the grounding bus in the distribution panelboard or disconnecting means.

(2) In the electrical system, all exposed metal parts, enclosures, frames, lamp fixture canopies, etc., shall be effectively bonded to the grounding terminal or enclosure of the distribution panelboard.

(3) Cord-connected appliances, such as washing machines, clothes dryers, refrigerators, and the electrical system of gas ranges, etc., shall be grounded by means of an approved cord with grounding conductor and grounding-type attachment plug.

(d) *Bonding of noncurrent-carrying metal parts.* (1) All exposed noncurrent-carrying metal parts that may become energized shall be effectively bonded to the grounding terminal or enclosure of the distribution panelboard. A bonding conductor shall be connected between each distribution panelboard and an accessible terminal on the chassis.

(2) Grounding terminals shall be of the solderless type and approved as pressure-terminal connectors recognized for the wire size used. Star washers or other approved paint-penetrating fitting shall be used to bond terminals to chassis or other coated areas. The bonding conductor shall be solid or stranded, insulated or bare and shall be

No. 8 copper minimum, or equal. The bonding conductor shall be routed so as not to be exposed to physical damage. Protection can be afforded by the configuration of the chassis.

(3) Metallic gas, water and waste pipes and metallic air-circulating ducts shall be considered bonded if they are connected to the terminal on the chassis (see §3280.809) by clamps, solderless connectors, or by suitable grounding-type straps.

(4) Any metallic roof and exterior covering shall be considered bonded if (i) the metal panels overlap one another and are securely attached to the wood or metal frame parts by metallic fasteners, and (ii) if the lower panel of the metallic exterior covering is secured by metallic fasteners at a cross member of the chassis by two metal straps per manufactured home unit or section at opposite ends. The bonding strap material shall be a minimum of 4 inches in width of material equivalent to the skin or a material of equal or better electrical conductivity. The straps shall be fastened with paint-penetrating fittings (such as screws and star washers or equivalent).

[40 FR 58752, Dec. 18, 1975. Redesignated at 44 FR 20679, Apr. 6, 1979, as amended at 58 FR 55020, Oct. 25, 1993]

§ 3280.810 Electrical testing.

(a) *Dielectric strength test.* The wiring of each manufactured home shall be subjected to a 1-minute, 900 to 1079 volt dielectric strength test (with all switches closed) between live parts and the manufactured home ground, and neutral and the manufactured home ground. Alternatively, the test may be performed at 1080 to 1250 volts for 1 second. This test shall be performed after branch circuits are complete and after fixtures or appliances are installed. Fixtures or appliances which are listed shall not be required to withstand the dielectric strength test.

(b) Each manufactured home shall be subject to:

(1) A continuity test to assure that metallic parts are properly bonded;

(2) Operational test to demonstrate that all equipment, except water heaters, electric furnaces, dishwashers, clothes washers/dryers, and portable

§ 3280.811

appliances, is connected and in working order; and

(3) Polarity checks to determine that connections have been properly made. Visual verification shall be an acceptable check.

[58 FR 55020, Oct. 25, 1993]

§ 3280.811 Calculations.

(a) The following method shall be employed in computing the supply cord and distribution-panelboard load for each feeder assembly for each manufactured home and shall be based on a 3-wire, 120/240 volt supply with 120 volt loads balanced between the two legs of the 3-wire system. The total load for determining power supply by this method is the summation of:

(1) Lighting and small appliance load as calculated below:

(i) Lighting volt-amperes: Length time width of manufactured home (outside dimensions exclusive of coupler) times 3 volt-amperes per square foot; e.g. Length × width × 3=lighting volt-amperes.

(ii) Small appliance volt-amperes: Number of circuits time 1,500 volt-amperes for each 20-ampere appliance receptacle circuit (see definition of "Appliance Portable" with Note); e.g. Number of circuits × 1,500=small appliance volt-amperes.

(iii) Total volts-amperes: Lighting volts-amperes plus small appliance=total volt-amperes.

(iv) First 3,000 total volts-amperes at 100 percent plus remainder at 35 percent=watts to be divided by 240 volts to obtain current (amperes) per leg.

(2) Nameplate amperes for motors and heater loads (exhaust fans, air conditioners, electric, gas, or oil heating). Omit smaller of air conditioning and heating except include blower motor if used as air conditioner evaporator motor. When an air conditioner is not installed and a 40-ampere power supply cord is provided, allow 15 amperes per leg for air conditioning.

(3) 25 percent of current of largest motor in paragraph (a)(2) of this section.

(4) Total of nameplate amperes for: Disposal, dishwasher, water heater, clothes dryer, wall-mounted oven, cooking units. Where number of these

24 CFR Ch. XX (4-1-11 Edition)

appliances exceeds three, use 75 percent of total.

(5) Derive amperes for free-standing range (as distinguished from separate ovens and cooking units) by dividing values below by 240 volts.

Nameplate rating (in watts)	Use (in watts)
10,000 or less	80 percent of rating.
10,001 to 12,500	8,000.
12,501 to 13,500	8,400.
13,501 to 14,500	8,800.
14,501 to 15,500	9,200.
15,501 to 16,500	9,600.
16,501 to 17,500	10,000.

(6) If outlets or circuits are provided for other than factory-installed appliances, include the anticipated load. The following example is given to illustrate the application of this Method of Calculation:

Example: A manufactured home is 70×10 feet and has two portable appliance circuits, a 1000 volt-ampere 240 volt heater, a 200 volt-ampere 120 volt exhaust fan, a 400 volts-ampere 120 volt dishwasher and a 7000 volt-ampere electric range.

Lighting and small appliance load	Volt-amperes
Lighting 70×10×3	2,100
Small Appliance	3,000
Total	5,100
1st. 3,000 Volt-Amperes at 100%	3,000
Remainder (5,100 - 3,000 =2,100, at 35%	735
Total	3,735

	Amperes per leg A	Amperes per leg B
Lighting and small Appliance	15.5	15.5
Heater 240 volt	4.1	4.1
Fan 120 volt	1.7
Dishwasher 120 volt	3.3
Range	23.3	23.3
Total	44.6	46.2

Note: Based on the higher current calculated for either leg, use one 50-A supply cord.

(b) The following is an optional method of calculation for lighting and appliance loads for manufactured homes served by single 3-wire 120/240 volt set of feeder conductors with an ampacity of 100 or greater. The total load for determining the feeder ampacity may be computed in accordance with the following table instead of the method previously specified. Feeder conductors whose demand load is determined by this optional calculation are permitted to have the neutral load

determined by Article 220.61 of the National Electrical Code, NFPA No. 70-2005. The loads identified in the table as "other load" and as "Remainder of other load" must include the following:

- (1) 1500 volt-amperes for each 2-wire, 20-ampere small appliance branch circuit and each laundry branch circuit specified.
- (2) 3 volt-amperes per square foot for general lighting and general-use receptacles.
- (3) The nameplate rating of all fixed appliances, ranges, wall-mounted ovens, counter-mounted cooking units, and including 4 or more separately controlled space heating loads.
- (4) The nameplate ampere or kVA rating of all motors and of all low-power-factor loads.
- (5) The largest of the following:
 - (i) Air conditioning load;
 - (ii) The 65 percent diversified demand of the central electric space heating load;
 - (iii) The 65 percent diversified demand of the load of less than four separately-controlled electric space heating units.
 - (iv) The connected load of four or more separately-controlled electric space heating units.

OPTIONAL CALCULATION FOR MANUFACTURED HOMES WITH 110-AMPERE OR LARGER SERVICE

Load (in kilowatt or kilovoltampere)	Demand factor (percent)
Air-conditioning and cooling including heat pump compressors	100
Central electric space heating	65
Less than 4 separately controlled electric space heating units	65
1st 10 kW of all other load	100
Remainder of other load	40

[40 FR 58752, Dec. 18, 1975. Redesignated at 44 FR 20679, Apr. 6, 1979, as amended at 58 FR 55021, Oct. 25, 1993; 70 FR 72052, Nov. 30, 2005]

§ 3280.812 Wiring of expandable units and dual units.

- (a) Expandable or multiple unit manufactured homes shall use fixed-type wiring methods and materials for connecting such units to each other.
- (b) Expandable or multiple unit manufactured homes not having permanently installed feeders and which are to be moved from one location to another,

shall be permitted to have disconnecting means with branch circuit protective equipment in each unit when so located that after assembly or joining together of units the requirements of § 3280.803 will be met.

§ 3280.813 Outdoor outlets, fixtures, air-conditioning equipment, etc.

- (a) Outdoor fixtures and equipment shall be listed for use in wet locations, except that if located on the underside of the home or located under roof extensions or similarly protected locations, they may be listed for use in damp locations.
- (b) A manufactured home provided with an outlet designed to energize heating and/or air conditioning equipment located outside the manufactured home, shall have permanently affixed, adjacent to the outlet, a metal tag which reads:

This Connection Is for Air Conditioning Equipment Rated at Not More Than _____ Amperes, at _____ Volts, 60 Hertz. A disconnect shall be located within sight of the appliance.

The correct voltage and ampere ratings shall be given. The tag shall not be less than 0.020 inch, etched Brass, stainless steel, anodized or alclad aluminum or equivalent or other approved material (e.g., .005 inch plastic laminates). The tag shall be not less than 3 inches by 1¾ inches minimum size.

[40 FR 58752, Dec. 18, 1975, as amended at 42 FR 961, Jan. 4, 1977. Redesignated at 44 FR 20679, Apr. 6, 1979, as amended at 58 FR 55021, Oct. 25, 1993]

§ 3280.814 Painting of wiring.

During painting or staining of the manufactured home, it shall be permitted to paint metal raceways (except where grounding continuity would be reduced) or the sheath of the non-metallic cable. Some arrangement, however, shall be made so that no paint shall be applied to the individual wires, as the color coding may be obliterated by the paint.

§ 3280.815 Polarization.

- (a) The identified (white) conductor shall be employed for grounding circuit conductors only and shall be connected to the identified (white) terminal or

§ 3280.816

24 CFR Ch. XX (4–1–11 Edition)

lead on receptacle outlets and fixtures. It shall be the unswitched wire in switched circuits, except that a cable containing an identified conductor (white) shall be permitted for single-pole three-way or four-way switch loops where the connections are made so that the unidentified conductor is the return conductor from the switch to the outlet. Painting of the terminal end of the wire shall not be required.

(b) If the identified (white) conductor of a cable is used for other than grounded conductors or for other than switch loops as explained above (for a 240 volt circuit for example), the conductor shall be finished in a color other than white at each outlet where the conductors are visible and accessible.

(c) Green-colored wires or green with yellow stripe shall be used for grounding conductors only.

[40 FR 58752, Dec. 18, 1975. Redesignated at 44 FR 20679, Apr. 6, 1979, as amended at 58 FR 55021, Oct. 25, 1993]

§ 3280.816 Examination of equipment for safety.

The examination or inspection of equipment for safety, according to this standard, shall be conducted under uniform conditions and by organizations properly equipped and qualified for experimental testing, inspections of the run of goods at factories, and service-value determinations through field examinations.

Subpart J—Transportation

§ 3280.901 Scope.

Subpart J of this standard covers the general requirement for designing the structure of the manufactured home to fully withstand the adverse effects of transportation shock and vibration without degradation of the integrated structure or of its component parts and the specific requirements pertaining to the transportation system and its relationship to the structure.

§ 3280.902 Definitions.

(a) *Chassis* means the entire transportation system comprising the following subsystems: drawbar and coupling mechanism, frame, running gear assembly, and lights.

(b) *Drawbar and coupling mechanism* means the rigid assembly, (usually an A frame) upon which is mounted a coupling mechanism, which connects the manufactured home's frame to the towing vehicle.

(c) *Frame* means the fabricated rigid substructure which provides considerable support to the affixed manufactured home structure both during transport and on-site; and also provides a platform for securement of the running gear assembly, the drawbar and coupling mechanism.

(d) *Running gear assembly* means the subsystem consisting of suspension springs, axles, bearings, wheels, hubs, tires, and brakes, with their related hardware.

(e) *Lights* means those safety lights and associated wiring required by applicable U.S. Department of Transportation regulations.

(f) *Transportation system*, (Same as chassis, above).

(g) *Highway*, includes all roads and streets to be legally used in transporting the manufactured home.

[40 FR 58752, Dec. 18, 1975. Redesignated at 44 FR 20679, Apr. 6, 1979, as amended at 47 FR 28093, June 29, 1982]

§ 3280.903 General requirements for designing the structure to withstand transportation shock and vibration.

(a) The cumulative effect of highway transportation shock and vibration upon a manufactured home structure may result in incremental degradation of its designed performance in terms of providing a safe, healthy and durable dwelling. Therefore, the manufactured home shall be designed, in terms of its structural, plumbing, mechanical and electrical systems, to fully withstand such transportation forces during its intended life. (See §§ 3280.303(c) and 3280.305(a)).

(b) Particular attention shall be given to maintaining watertight integrity and conserving energy by assuring that structural components in the roof and walls (and their interfaces with vents, windows, doors, etc.) are capable of resisting highway shock and vibration forces during primary and subsequent secondary transportation moves.

(c) In place of an engineering analysis, either of the following may be accepted:

(1) Documented technical data of suitable highway tests which were conducted to simulate transportation loads and conditions; or

(2) Acceptable documented evidence of actual transportation experience which meets the intent of this subpart.

§ 3280.904 Specific requirements for designing the transportation system.

(a) *General.* The entire system (frame, drawbar and coupling mechanism, running gear assembly, and lights) shall be designed and constructed as an integrated, balanced and durable unit which is safe and suitable for its specified use during the intended life of the manufactured home. In operation, the transportation system (supporting the manufactured home structure and its contents) shall effectively respond to the control of the braking, while traveling at applicable towing vehicle in terms of tracking and highway speeds and in normal highway traffic conditions.

NOTE: While the majority of manufactured homes utilize a fabricated steel frame assembly, upon which the manufactured home structure is constructed, it is not the intent of this standard to limit innovation. Therefore, other concepts, such as integrating the frame function into the manufactured home structure, are acceptable provided that such design meets the intent and requirements of this part).

(b) *Specific requirements—(1) Drawbar.* The drawbar shall be constructed of sufficient strength, rigidity and durability to safely withstand those dynamic forces experienced during highway transportation. It shall be securely fastened to the manufactured home frame by either a continuous weld or by bolting.

(2) *Coupling mechanism.* The coupling mechanism (which is usually of the socket type) shall be securely fastened to the drawbar in such a manner as to assure safe and effective transfer of the maximum loads, including dynamic loads, between the manufactured home structure and the hitch-assembly of the towing vehicle. The coupling shall be equipped with a manually operated mechanism so adapted as to prevent

disengagement of the unit while in operation. The coupling shall be so designed that it can be disconnected regardless of the angle of the manufactured home to the towing vehicle. With the manufactured home parked on level ground, the center of the socket of the coupler shall not be less than 20 inches nor more than 26 inches from ground level.

(3) *Chassis.* The chassis, in conjunction with the manufactured home structure, shall be designed and constructed to effectively sustain the designed loads consisting of the dead load plus a minimum of 3 pounds per square foot floor load, (example: free-standing range, refrigerator, and loose furniture) and the superimposed dynamic load resulting from highway movement but shall not be required to exceed twice the dead load. The integrated design shall be capable of insuring rigidity and structural integrity of the complete manufactured home structure and to insure against deformation of structural or finish members during the intended life of the home.

(4) *Running gear assembly.* (i) The running gear assembly, as part of the chassis, shall be designed to perform, as a balanced system, in order to effectively sustain the designed loads set forth in § 3280.904(b)(3) and to provide for durable dependable safe mobility of the manufactured home. It shall be designed to accept shock and vibration, both from the highway and the towing vehicle and effectively dampen these forces so as to protect the manufactured home structure from damage and fatigue. Its components shall be designed to facilitate routine maintenance, inspection and replacement.

(ii) Location of the running gear assembly shall be determined by documented engineering analysis, taking into account the gross weight (including all contents), total length of the manufactured home, the necessary coupling hitch weight, span distance, and turning radius. The coupling weight shall be not less than 12 percent nor more than 25 percent of the gross weight.

(5) *Spring assemblies.* Spring assemblies (springs, hangers, shackles, bushings and mounting bolts) shall be capable of withstanding all the design loads

as outlined in §3280.904(b)(3) without exceeding maximum allowable stresses for design spring assembly life as recommended by the spring assembly manufacturer. The capacity of the spring system shall assure, that under maximum operating load conditions, sufficient clearance shall be maintained between the tire and manufactured home frame or structure to permit unimpeded wheel movement and for changing tires.

(6) *Axles.* Axles, and their connecting hardware, shall be capable of withstanding all of the design loads outlined in §3280.904(b)(3) without exceeding maximum allowable stresses for design axle life as recommended by the axle manufacturer. The number of axles required to provide a safe tow and good ride characteristics shall be determined and documented by engineering analysis. Those alternatives listed in §3280.903(c) may be accepted in place of such an analysis.

(7) *Hubs and bearings.* Hubs and bearings shall meet the requirements of §3280.904(b)(3) and good engineering practice. Both of these components shall be accessible for inspection, routine maintenance and replacement of parts.

(8) *Tires, wheels and rims.* Tires, wheels and rims shall meet the requirements of §3280.904(b)(3). Tires shall be selected for anticipated usage.

(9) *Brake assemblies.* (i) The number, type, size and design of brake assemblies required to assist the towing vehicle in providing effective control and stopping of the manufactured home shall be determined and documented by engineering analysis. Those alternatives listed in §3280.903(c) may be accepted in place of such an analysis.

(ii) Brakes on the towing vehicle and the manufactured home shall be capable of assuring that the maximum stopping distance from an initial velocity of 20 miles per hour does not exceed 40 feet (U.S. Department of Transportation Regulations).

(10) *Lights and associated wiring.* Highway safety electrical lights and associated wiring shall conform to applicable Federal requirements in terms of location and performance. The manufacturer shall have the option of meeting this requirement by utilizing a tem-

porary light/wiring harness provided by the manufactured home transportation carrier.

PART 3282—MANUFACTURED HOME PROCEDURAL AND ENFORCEMENT REGULATIONS

Subpart A—General

- Sec.
- 3282.1 Scope and purpose.
 - 3282.6 Separability of provisions.
 - 3282.7 Definitions.
 - 3282.8 Applicability.
 - 3282.9 Computation of time.
 - 3282.10 Civil and criminal penalties.
 - 3282.11 Preemption and reciprocity.
 - 3282.12 Excluded structures—modular homes.
 - 3282.13 Voluntary certification.
 - 3282.14 Alternative construction of manufactured homes.

Subpart B—Formal Procedures

- 3282.51 Scope.
- 3282.52 Address of communications.
- 3282.53 Service of process on foreign manufacturers and importers.
- 3282.54 Public information.

Subpart C—Rules and Rulemaking Procedures

- 3282.101 Generally.
- 3282.111 Petitions for reconsideration of final rules.
- 3282.113 Interpretative bulletins.

Subpart D—Informal and Formal Presentations of Views, Hearings and Investigations

- 3282.151 Applicability and scope.
- 3282.152 Procedures to present views and evidence.
- 3282.153 Public participation in formal or informal presentation of views.
- 3282.154 Petitions for formal or informal presentations of views, and requests for extraordinary interim relief.
- 3282.155 Investigations.
- 3282.156 Petitions for investigations.

Subpart E—Manufacturer Inspection and Certification Requirements

- 3282.201 Scope and purpose.
- 3282.202 Primary inspection agency contracts.
- 3282.203 DAPIA services.
- 3282.204 IPIA services.
- 3282.205 Certification requirements.
- 3282.206 Disagreement with IPIA or DAPIA.

Office of Asst. Sec. for Housing, HUD

§ 3282.1

- 3282.207 Manufactured home consumer manual requirements.
- 3282.208 Remedial actions—general description.
- 3282.209 Report requirements.
- 3282.210 Payment of monitoring fee.
- 3282.211 Record of purchasers.

Subpart F—Dealer and Distributor Responsibilities

- 3282.251 Scope and purpose.
- 3282.252 Prohibition of sale.
- 3282.253 Removal of prohibition of sale.
- 3282.254 Distributor and dealer alterations.
- 3282.255 Completion of information card.
- 3282.256 Distributor or dealer complaint handling.

Subpart G—State Administrative Agencies

- 3282.301 General—scope.
- 3282.302 State plan.
- 3282.303 State plan—suggested provisions.
- 3282.304 Inadequate State plan.
- 3282.305 State plan approval.
- 3282.306 Withdrawal of State approval.
- 3282.307 Monitoring inspection fee establishment and distribution.
- 3282.308 State participation in monitoring of primary inspection agencies.
- 3282.309 Formal and informal presentations of views held by SAAs.

Subpart H—Primary Inspection Agencies

- 3282.351 General.
- 3282.352 State exclusive IPIA functions.
- 3282.353 Submission format.
- 3282.354 Submittal of false information or refusal to submit information.
- 3282.355 Submission acceptance.
- 3282.356 Disqualification and requalification of primary inspection agencies.
- 3282.357 Background and experience.
- 3282.358 Personnel.
- 3282.359 Conflict of interest.
- 3282.360 PIA acceptance of product certification programs or listings.
- 3282.361 Design Approval Primary Inspection Agency (DAPIA).
- 3282.362 Production Inspection Primary Inspection Agencies (IPIAs).
- 3282.363 Right of entry and inspection.
- 3282.364 Inspection responsibilities and coordination.
- 3282.365 Forwarding monitoring fee.
- 3282.366 Notification and correction campaign responsibilities.

Subpart I—Consumer Complaint Handling and Remedial Actions

- 3282.401 Purpose and scope.
- 3282.402 General principles.
- 3282.403 Consumer complaint and information referral.

- 3282.404 Notification pursuant to manufacturer's determination.
- 3282.405 SAA responsibilities.
- 3282.406 Required manufacturer correction.
- 3282.407 Notification and correction pursuant to administrative determination.
- 3282.408 Reimbursement for prior correction by owner.
- 3282.409 Manufacturer's plan for notification and correction.
- 3282.410 Contents of notice.
- 3282.411 Time for implementation.
- 3282.412 Completion of remedial actions and report.
- 3282.413 Replacement or repurchase of manufactured home from purchaser.
- 3282.414 Manufactured homes in the hands of dealers and distributors.
- 3282.415 Notices, bulletins and other communications.
- 3282.416 Supervision of notification and correction actions.

Subpart J—Monitoring of Primary Inspection Agencies

- 3282.451 General.
- 3282.452 Participation in monitoring.
- 3282.453 Frequency and extent of monitoring.

Subpart K—Departmental Oversight

- 3282.501 General.
- 3282.502 Departmental implementation.
- 3282.503 Determinations and hearings.

Subpart L—Manufacturer, IPIA and SAA Reports

- 3282.551 Scope and purpose.
- 3282.552 Manufacturer reports for joint monitoring fees.
- 3282.553 IPIA reports.
- 3282.554 SAA reports.

AUTHORITY: 28 U.S.C. 2461 note; 42 U.S.C. 3535(d) and 5424.

SOURCE: 41 FR 19852, May 13, 1976, unless otherwise noted.

Subpart A—General

§ 3282.1 Scope and purpose.

(a) The National Manufactured Housing Construction and Safety Standards Act of 1974 (title VI of Pub. L. 93-383, 88 Stat. 700, 42 U.S.C. 5401, *et seq.*) (hereinafter referred to as the Act), requires the Secretary of the Department of Housing and Urban Development to establish Federal manufactured home construction and safety standards and to issue regulations to carry out the

§ 3282.6

24 CFR Ch. XX (4–1–11 Edition)

purpose of the Act. The standards promulgated pursuant to the Act appear at part 3280 of chapter XX of this title, and apply to all manufactured homes manufactured for sale to purchasers in the United States on or after the effective date of the standards (June 15, 1976). A manufactured home is manufactured on or after June 15, 1976, if it enters the first stage of production on or after that date.

(b) The Secretary is also authorized by the Act to conduct inspections and investigations necessary to enforce the standards, to determine that a manufactured home fails to comply with an applicable standard or contains a defect or an imminent safety hazard, and to direct the manufacturer to furnish notification thereof, and in some cases, to remedy the defect or imminent safety hazard. The purpose of this part is to prescribe procedures for the implementation of these responsibilities of the Secretary under the Act through the use of private and State inspection organizations and cooperation with State manufactured home agencies. It is the policy of the Department to involve State agencies in the enforcement of the Federal manufactured home standards to the maximum extent possible consistent with the capabilities of such agencies and the public interest. The procedures for investigations and investigational proceedings are set forth in 24 CFR part 3800.

[41 FR 19852, May 13, 1976, as amended at 61 FR 10442, Mar. 13, 1996]

§ 3282.6 Separability of provisions.

If any clause, sentence, paragraph, section or other portion of part 3282 shall, for any reason, be adjudged by any court of competent jurisdiction to be invalid, such judgment shall not affect, impair, or invalidate the remainder thereof, but shall be confined by its operation to the clause, sentence, paragraph, or part thereof directly involved in the controversy in which such judgment shall have been rendered.

§ 3282.7 Definitions.

The terms *Department*, *HUD*, and *Secretary* are defined in 24 CFR part 5.

(a) *Act* means the National Manufactured Housing Construction and Safety Standards Act of 1974, title VI of the

Housing and Community Development Act of 1974 (42 U.S.C. 5401 *et seq.*)

(b) *Add-on* means any structure (except a structure designed or produced as an integral part of a manufactured home) which, when attached to the basic manufactured home unit, increases the area, either living or storage, of the manufactured home.

(c) *Alteration* means the replacement, addition, and modification, or removal of any equipment or installation after sale by a manufacturer to a dealer or distributor but prior to sale by a dealer to a purchaser which may affect the construction, fire safety, occupancy, plumbing, heat-producing or electrical system. It includes any modification made in the manufactured home which may affect the compliance of the home with the standards, but it does not include the repair or replacement of a component or appliance requiring plug-in to an electrical receptacle where the replaced item is of the same configuration and rating as the one being replaced. It also does not include the addition of an appliance requiring *plug-in* to an electrical receptacle, which appliance was not provided with the manufactured home by the manufacturer, if the rating of the appliance does not exceed the rating of the receptacle to which it is connected.

(d) *Certification label* see *label*.

(e) *Certification report* means the report prepared by an IPIA (see definition *z*) for each manufactured home manufacturing plant under § 3282.203 in which the IPIA provides a complete description of the initial comprehensive inspection of the plant, an evaluation of the quality assurance program under the approved quality assurance manual, and the identity of the DAPIA (see definition *z*) which approved the designs and quality assurance manual used in the plant. Where appropriate under § 3282.362(b)(5), the certification report may be made by a DAPIA.

(f) *Component* means any part, material or appliance which is built in as an integral part of the manufactured home during the manufacturing process.

(g) *Cost information* means information submitted by a manufacturer

under section 607 of the Act with respect to alleged cost increases resulting from action by the Secretary, in such form as to permit the public and the Secretary to make an informed judgment on the validity of the manufacturer's statements. Such term includes both the manufacturer's cost and the cost to retail purchasers.

(h) *Date of manufacture* means the date on which the label required by §3282.205(c) is affixed to the manufactured home.

(i) *Dealer* means any person engaged in the sale, leasing, or distribution of new manufactured homes primarily to persons who in good faith purchase or lease a manufactured home for purposes other than resale.

(j) *Defect* means a failure to comply with an applicable Federal manufactured home safety and construction standard that renders the manufactured home or any part or component thereof not fit for the ordinary use for which it was intended, but does not result in an unreasonable risk of injury or death to occupants of the affected manufactured home. See related definitions of *imminent safety hazard* (definition q), *noncompliance* (definition x), and *serious defect* (definition ff).

(k) *Design* means drawings, specifications, sketches and the related engineering calculations, tests and data in support of the configurations, structures and systems to be incorporated in manufactured homes manufactured in a plant.

(l) *Director* means the Director of the Manufactured Housing Standards Division.

(m) *Distributor* means any person engaged in the sale and distribution of manufactured homes for resale.

(n) *Failure to conform* means an imminent safety hazard related to the standards, a serious defect, defect, or noncompliance and is used as a substitute for all of those terms.

(o) [Reserved]

(p) *Imminent safety hazard* means a hazard that presents an imminent and unreasonable risk of death or severe personal injury that may or may not be related to failure to comply with an applicable Federal manufactured home construction or safety standard. See related definitions of *defect* (definition

j), *noncompliance* (paragraph x) and *serious defect* (paragraph ff).

(q) *Joint monitoring team* means a monitoring inspection team composed of personnel provided by the various State Administrative Agencies, or by HUD or its contract agent, operating under a contract with HUD for the purpose of monitoring, or otherwise aiding in the enforcement of the Federal standards.

(r) *Label* or *certification label* means the approved form of certification by the manufacturer that, under §3282.362(c)(2)(i), is permanently affixed to each transportable section of each manufactured home manufactured for sale to a purchaser in the United States.

(s) (Same as §3280.2(a)(13).)

(t) *Manufacturer* means any person engaged in manufacturing or assembling manufactured homes, including any person engaged in importing manufactured homes for resale.

(u) (Same as §3280.2(a)(16).)

(v) *Manufactured home construction* means all activities relating to the assembly and manufacture of a manufactured home including but not limited to those relating to durability, quality, and safety.

(w) *Manufactured home safety* means the performance of a manufactured home in such a manner that the public is protected against any unreasonable risk of the occurrence of accidents due to the design or construction of such manufactured home, or any unreasonable risk of death or injury to the user or to the public if such accidents do occur.

(x) *Noncompliance* means a failure of a manufactured home to comply with a Federal manufactured home construction or safety standard that does not constitute a defect, serious defect, or imminent safety hazard. See related definitions or *defect* (definition j), *imminent safety hazard* (definition q), and *serious defect* (definition ff).

(y) *Owner* means any person purchasing a manufactured home from any other person after the first purchase of the manufactured home, in good faith, for purposes other than resale.

(z) *Primary Inspection Agency* (PIA) means a State/or private organization

§ 3282.8

that has been accepted by the Secretary in accordance with the requirement of subpart H of this part. There are two types of PIA:

(1) Design Approval PIA (DAPIA), which evaluates and approves or disapproves manufactured home designs and quality control procedures, and

(2) Production Inspection PIA (IPIA), which evaluates the ability of manufactured home manufacturing plants to follow approved quality control procedures and provides ongoing surveillance of the manufacturing process. Organizations may act as one or both of these types.

(aa) *Purchaser* means the first person purchasing a manufactured home in good faith for purposes other than resale.

(bb) *Quality Assurance Manual* means a manual, prepared by each manufacturer for its manufacturing plants and approved by a DAPIA which contains: a statement of the manufacturer's quality assurance program, a chart of the organization showing, by position, all personnel accountable for quality assurance, a list of tests and test equipment required, a station-by-station description of the manufacturing process, a list of inspections required at each station, and a list by title of personnel in the manufacturer's organization to be held responsible for each inspection. Where necessary, the quality assurance manual used in a particular plant shall contain information specific to that plant.

(cc) *To red tag* means to affix a notice to a manufactured home which has been found to contain an imminent safety hazard or a failure to conform with any applicable standard. A *red tag* is the notice so affixed to the manufactured home.

(dd) [Reserved]

(ee) *Secretary's agent* means a party operating as an independent contractor under a contract with HUD.

(ff) *Serious defect* means any failure to comply with an applicable Federal manufactured home construction and safety standard that renders the manufactured home or any part thereof not fit for the ordinary use for which it was intended and which results in an unreasonable risk of injury or death to occu-

24 CFR Ch. XX (4-1-11 Edition)

pants of the affected manufactured home.

(gg) *Standards* means the Federal manufactured home construction and safety standards promulgated under section 604 of the Act, 42 U.S.C. 5403, as part 3280 of these regulations.

(hh) *State* includes each of the several States, the District of Columbia, the Commonwealth of Puerto Rico, Guam, the Virgin Islands, the Canal Zone, and American Samoa.

(ii) *State Administrative Agency* (SAA) means an agency of a State which has been approved or conditionally approved to carry out the State plan for enforcement of the standards pursuant to section 623 of the Act, 42 U.S.C. 5422, and subpart G of this part.

(jj) *State plan application* means the application of any State organization which is submitted to the Secretary for approval as a State Administrative Agency under subpart G.

(kk) *System* means a set or arrangement of materials or components related or connected as to form an operating entity, i.e., heating, ventilating and air-conditioning systems, evaporative coolers.

(ll) [Reserved]

(mm) *United States District Courts* means the Federal district courts of the United States and the United States courts of the Commonwealth of Puerto Rico, Guam, the Virgin Islands, the Canal Zone, and American Samoa.

(nn) (Same as § 3280.2(a)(22).)

[41 FR 19852, May 13, 1976, as amended at 41 FR 24971, June 21, 1976; 47 FR 28093, June 29, 1982; 61 FR 5216, Feb. 9, 1996; 61 FR 10859, Mar. 15, 1996]

§ 3282.8 Applicability.

(a) *Mobile homes*. This part applies to all manufactured homes that enter the first stage of production on or after June 15, 1976, and to all manufactured homes that enter the first stage of production before June 15, 1976, to which labels are applied under § 3282.205(d).

(b) *States*. This part applies to States that desire to assume responsibility under the Federal manufactured home construction and safety standards enforcement program. It includes requirements which must be met in order for State agencies to be approved by the Secretary under section 623(c) of

the Act, 42 U.S.C. 5422(c). It also includes requirements for States wishing to act as primary inspection agencies, as defined in §3282.7, or to participate in monitoring activities under §3282.308.

(c) *Primary inspection and engineering organizations.* This part applies to each private inspection and engineering organization that wishes to qualify as a primary inspection agency under subpart H.

(d) *Manufactured home manufacturers.* This part applies to all manufacturers producing manufactured homes for sale in the United States. It includes:

(1) Inspection procedures to be carried out in the manufacturing plants.

(2) Procedures by which a manufacturer obtains approval of manufactured home designs.

(3) Procedures by which a manufacturer obtains approval of manufacturing quality control and assurance programs.

(4) Procedures by which a manufacturer may obtain production inspections and certification labels for its manufactured homes.

(e) *Manufactured home dealers and distributors.* This part applies to any person selling, leasing, or distributing new manufactured homes for use in the United States. It includes prohibitions of the sale of new manufactured homes to which labels have not been affixed pursuant to subpart H of these regulations or that have been altered, damaged, or otherwise caused not to be in compliance with the Federal standards.

(f) *Purchasers, owners and consumers.* This part applies to purchasers, owners and consumers of manufactured homes in that it sets out procedures to be followed when purchasers, owners and consumers complain to manufacturers, States, the Secretary or others concerning problems in manufactured homes for which remedies are provided under the Act.

(g) *Recreational vehicles.* Recreational vehicles are not subject to this part, part 3280, or part 3283. A recreational vehicle is a vehicle which is:

(1) Built on a single chassis;

(2) 400 Square feet or less when measured at the largest horizontal projections;

(3) Self-propelled or permanently towable by a light duty truck; and

(4) Designed primarily not for use as a permanent dwelling but as temporary living quarters for recreational, camping, travel, or seasonal use.

(h) *Imported manufactured homes.* Imported manufactured homes are covered by the regulations except as modified by regulations promulgated jointly by the Secretary and the Secretary of the Treasury.

(i) *Export manufactured homes.* Manufactured Homes intended solely for export are not governed by this part or by part 3280 of this title if a label or tag stating that the manufactured home is intended solely for export is placed on the manufactured home or the outside of the container, if any, in which it is to be exported. However, any manufactured home so tagged or labeled that is not exported but is sold to a purchaser in the United States is subject to this part and part 3280 of this title.

(j) *Add-on.* An add-on added by the dealer or some other party not the manufacturer (except where the manufacturer acts as a dealer) as part of a simultaneous transaction involving the sale of a new manufactured home, is not governed by the standards and is not subject to these regulations. However, the addition of the add-on must not affect the ability of the basic manufactured home to comply with the standards. If the addition of an add-on causes the basic manufactured home to fail to conform to the standards, sale, lease, and offer for sale or lease of the home is prohibited until the manufactured home is brought into conformance with the standards. While the standards do not govern add-ons, the Secretary has the authority to promulgate standards for add-ons and may do so in the future.

(k) A structure (including an expandable room, tip-out, or tag-along unit) which is designed and produced as an integral part of a manufactured home when assembled on site, is governed by the standards and these regulations regardless of the dimensions of such structure.

(l) *Multifamily homes.* Mobile homes designed and manufactured with more than one separate living unit are not

§ 3282.9

covered by the standards and these regulations.

[41 FR 19852, May 13, 1976, as amended at 41 FR 24970, June 21, 1976; 42 FR 35013, July 7, 1977; 44 FR 68733, Nov. 29, 1979; 47 FR 28093, June 29, 1982]

§ 3282.9 Computation of time.

(a) In computing any period of time prescribed by the regulations in this part, refer to § 26.16(a) of this title.

(b) Extensions of any of the time periods set out in these regulations may be granted by the Secretary or, as appropriate, by a State Administrative Agency, upon a showing of good cause by the party governed by the time period.

[42 FR 2580, Jan. 12, 1977, as amended at 61 FR 10859, Mar. 15, 1996]

§ 3282.10 Civil and criminal penalties.

Failure to comply with these regulations may subject the party in question to the civil and criminal penalties provided for in section 611 of the Act, 42 U.S.C. 5410. The maximum amount of penalties imposed under section 611 of the Act shall be \$1,100 for each violation, up to a maximum of \$1,375,000 for any related series of violations occurring within one year from the date of the first violation.

[72 FR 5589, Feb. 6, 2007]

§ 3282.11 Preemption and reciprocity.

(a) No State manufactured home standard regarding manufactured home construction and safety which covers aspects of the manufactured home governed by the Federal standards shall be established or continue in effect with respect to manufactured homes subject to the Federal standards and these regulations unless it is identical to the Federal standards.

(b) No State may require, as a condition of entry into or sale in the State, a manufactured home certified (by the application of the label required by § 3282.362(c)(2)(i)) as in conformance with the Federal standards to be subject to State inspection to determine compliance with any standard covering any aspect of the manufactured home covered by the Federal standards. Nor may any State require that a State label be placed on the manufactured

24 CFR Ch. XX (4–1–11 Edition)

home certifying conformance to the Federal standard or an identical standard. Certain actions that States are permitted to take are set out in § 3282.303.

(c) States may participate in the enforcement of the Federal standards enforcement program under these regulations either as SAAs or PIAs or both. These regulations establish the exclusive system for enforcement of the Federal standards. No State may establish or keep in effect through a building code enforcement system or otherwise, procedures or requirements which constitute systems for enforcement of the Federal standards or of identical State standards which are outside the system established in these regulations or which go beyond this system to require remedial actions which are not required by the Act and these regulations. A State may establish or continue in force consumer protections, such as warranty or warranty performance requirements, which respond to individual consumer complaints and so do not constitute systems of enforcement of the Federal standards, regardless of whether the State qualifies as an SAA or PIA.

(d) No State or locality may establish or enforce any rule or regulation or take any action that stands as an obstacle to the accomplishment and execution of the full purposes and objectives of Congress. The test of whether a State rule or action is valid or must give way is whether the State rule can be enforced or the action taken without impairing the Federal superintendence of the manufactured home industry as established by the Act.

[42 FR 2580, Jan. 12, 1977, as amended at 56 FR 65186, Dec. 16, 1991; 61 FR 10859, Mar. 15, 1996]

§ 3282.12 Excluded structures—modular homes.

(a) The purpose of this section is to provide the certification procedure authorized by section 604(h) of the National Manufactured Housing Construction and Safety Standards Act under which modular homes may be excluded from coverage of the Act if the manufacturer of the structure elects to have

them excluded. If a manufacturer wishes to construct a structure that is both a manufactured home and a modular home, the manufacturer need not make the certification provided for by this section and may meet both the Federal manufactured home requirements and any modular housing requirements. When the certification is not made, all provisions of the Federal requirements shall be met.

(b) Any structure that meets the definition of *manufactured home* at 24 CFR 3282.7(u) is excluded from the coverage of the National Manufactured Housing Construction and Safety Standards Act, 42 U.S.C. 5401 *et seq.*, if the manufacturer certifies as prescribed in paragraph (c) of this section that:

(1) The structure is designed only for erection or installation on a site-built permanent foundation;

(i) A structure meets this criterion if all written materials and communications relating to installation of the structure, including but not limited to designs, drawings, and installation or erection instructions, indicate that the structure is to be installed on a permanent foundation.

(ii) A site-built permanent foundation is a system of supports, including piers, either partially or entirely below grade which is:

(A) Capable of transferring all design loads imposed by or upon the structure into soil or bedrock without failure,

(B) Placed at an adequate depth below grade to prevent frost damage, and

(C) Constructed of concrete, metal, treated lumber or wood, or grouted masonry; and

(2) The structure is not designed to be moved once erected or installed on a site-built permanent foundation;

(i) A structure meets this criterion if all written materials and communications relating to erection or installation of the structure, including but not limited to designs, drawings, calculations, and installation or erection instructions, indicate that the structure is not intended to be moved after it is erected or installed and if the towing hitch or running gear, which includes axles, brakes, wheels and other parts of the chassis that operate only during transportation, are removable and de-

signed to be removed prior to erection or installation on a site-built permanent foundation; and

(3) The structure is designed and manufactured to comply with the currently effective version of one of the following:

(i) One of the following nationally recognized building codes:

(A) That published by Building Officials and Code Administrators (BOCA) and the National Fire Protection Association (NFPA) and made up of the following:

(1) BOCA Basic Building Code,

(2) BOCA Basic Industrialized Dwelling Code,

(3) BOCA Basic Plumbing Code,

(4) BOCA Basic Mechanical Code, and

(5) National Electrical Code, or

(B) That published by the Southern Building Code Congress (SBCC) and the NFPA and made up of the following:

(1) Standard Building Code,

(2) Standard Gas Code,

(3) Standard Mechanical Code,

(4) Standard Plumbing Code, and

(5) National Electrical Code, or

(C) That published by the International Conference of Building Officials (ICBO), the International Association of Plumbing and Mechanical Officials (IAPMO), and the NFPA and made up of the following:

(1) Uniform Building Code,

(2) Uniform Mechanical Code,

(3) Uniform Plumbing Code, and

(4) National Electrical Code or

(D) The codes included in paragraphs (b)(3)(i)(A), (B), or (C) in connection with the One- and Two-Family Dwelling Code, or

(E) Any combination of the codes included in paragraphs (b)(3)(i)(A), (B), (C), and (D), that is approved by the Secretary, including combinations using the National Standard Plumbing Code published by the National Association of Plumbing, Heating and Cooling Contractors (PHCC), or

(F) Any other building code accepted by the Secretary as a nationally recognized model building code, or

(ii) Any local code or State or local modular building code accepted as generally equivalent to the codes included under paragraph (b)(3)(i), (the Secretary will consider the manufacturer's certification under paragraph (c) of

this section to constitute a certification that the code to which the structure is built is generally equivalent to the referenced codes. This certification of equivalency is subject to the provisions of paragraph (f) of this section) or

(iii) The minimum property standards adopted by the Secretary pursuant to title II of the National Housing Act; and

(4) To the manufacturer's knowledge, the structure is not intended to be used other than on a site-built permanent foundation.

(c) When a manufacturer makes a certification provided for under paragraph (b) of this section, the certification shall state as follows:

The manufacturer of this structure, Name _____; Address _____; (location where structure was manufactured).

Certifies that this structure (Ser. No. _____) is not a manufactured home subject to the provisions of the National Manufactured Housing Construction and Safety Standards Act and is—

(1) designed only for erection or installation on a site-built permanent foundation,

(2) not designed to be moved once so erected or installed,

(3) designed and manufactured to comply with _____ (Here state which code included in paragraph (b)(3) of this section has been followed), and

(4) to the manufacturer's knowledge is not intended to be used other than on a site-built permanent foundation.

(d) This certification shall be affixed in a permanent manner near the electrical panel, on the inside of a kitchen cabinet door, or in any other readily accessible and visible location.

(e) As part of this certification, the manufacturer shall identify each certified structure by a permanent serial number placed on the structure during the first stage of production. If the manufacturer also manufactures manufactured homes that are certified under §§ 3282.205 and 3282.362(c), the series of serial numbers for structures certified under this section shall be distinguishable on the structures and in the manufacturer's records from the series of serial numbers for the manufactured homes that are certified under §§ 3282.205 and 3282.362(c).

(1) If a manufacturer wishes to certify a structure as a manufactured home under §§ 3282.205 and 3282.362(c) after having applied a serial number identifying it as exempted under this section, the manufacturer may do so only with the written consent of the Production Inspection Primary Inspection Agency (IPIA) after thorough inspection of the structure by the IPIA at at least one stage of production and such removal or equipment, components, or materials as the IPIA may require to perform inspections to assure that the structure conforms to the Federal manufactured home standards. The manufacturer shall remove the original serial number and add the serial number required by § 3280.6.

(2) A manufacturer may not certify a structure under this section after having applied the manufactured home serial number under § 3280.6.

(f) All certifications made under this section are subject to investigation by the Secretary to determine their accuracy. If a certification is false or inaccurate, the certification for purposes of this section is invalid and the structures that have been or may be the subject of the certification are not excluded from the coverage of the Act, the Federal Manufactured Home Construction and Safety Standards, or these Regulations.

(1) If the Secretary has information that a certification may be false or inaccurate, the manufacturer will be given written notice of the nature of this information by certified mail and the procedure of this subparagraph will be followed.

(i) The manufacturer must investigate this matter and report its findings in writing as to the validity of this information to the Secretary within 15 days from the receipt of the Secretary's notice.

(ii) If a written report is received within the time prescribed in paragraph (f)(1)(i) of this section, the Secretary will review this report before determining whether a certification is false or inaccurate. If a report is not received within 15 days from the receipt of the Secretary's notice, the Secretary will make the determination on the basis of the information presented.

(iii) If the Secretary determines that a certification is false or inaccurate, the manufacturer will be given written notice and the reasons for this determination by certified mail.

(2) The Secretary may seek civil and criminal penalties provided for in section 611 of the Act, 42 U.S.C. 5410, if the party in question in the exercise of due care has reason to know that such certification is false or misleading as to any material fact.

[44 FR 68733, Nov. 29, 1979, as amended at 49 FR 10666, Mar. 22, 1984]

§ 3282.13 Voluntary certification.

(a) The purpose of this section is to provide a procedure for voluntary certification of non-conforming manufactured homes as required by 42 U.S.C. 5402(6) as amended by section 308(d)(B) of the Housing and Community Development Act of 1980.

(b) Structures which meet all of the requirements of a *manufactured home* as set out in § 3282.7(u), except the size requirements, shall be *manufactured homes* if the manufacturer files with the Secretary a certification in the following form:

[Name of manufacturer and address where structures are to be manufactured] certifies that it intends to manufacture structures that meet all of the requirements of manufactured homes set forth at 42 U.S.C. 5402(6) except the size requirements. Such structures are to be treated as manufactured homes for the purposes of the National Manufactured Housing Construction and Safety Standards Act of 1974 and the regulations promulgated pursuant thereto. Such structures will be built in conformance with the Standards. [Name of manufacturer] further certifies that if, at any time it manufactures structures which are not manufactured homes, it will identify each such structure by a permanent serial number placed on the structure during the first stage of production and that the series of serial numbers for such structures shall be distinguishable on the structures and in its records from the series of serial numbers used for manufactured homes.

(c) Whenever a manufacturer which has filed a certification pursuant to § 3282.13(b) produces structures which are not manufactured homes, it must identify each such structure by placing a permanent serial number on the structure during the first stage of pro-

duction. The series of serial numbers placed on these structures shall be distinguishable on the structure and in the manufacturer's records from the series of serial numbers used for manufactured homes.

(d) A manufacturer may certify a structure as a manufactured home after having applied a serial number identifying it as a structure which is not a manufactured home. To do so, the manufacturer must secure the written consent of the IPIA. This consent may only be given after a DAPIA has approved the manufacturer's design and quality assistance manual in accordance with § 3282.361, and after the IPIA has thoroughly inspected the structure in at least one stage of production and after such removal of equipment, components or materials as the IPIA may require to assure that the structure conforms to the standards. After certification as a manufactured home has been approved, the manufacturer shall remove the original serial number and add the serial number required by § 3280.6.

(e) Once a manufacturer has certified under § 3282.13(b) that it intends to build structures which are manufactured homes in all respects except size, the manufacturer must then, with respect to those structures, comply with all of the requirements of the Act and its regulations. The structures may not thereafter be exempted under any other section of these regulations.

[47 FR 28093, June 29, 1982]

§ 3282.14 Alternative construction of manufactured homes.

(a) *Policy.* In order to promote the purposes of the Act, the Department will permit the sale or lease of one or more manufactured homes not in compliance with the Standards under circumstances wherein no affirmative action is needed to protect the public interest. The Department encourages innovation and the use of new technology in manufactured homes. Accordingly, HUD will permit manufacturers to utilize new designs or techniques not in compliance with the Standards in cases:

(1) Where a manufacturer proposes to utilize construction that would be prohibited by the Standards;

§ 3282.14

24 CFR Ch. XX (4-1-11 Edition)

(2) Where such construction would provide performance that is equivalent to or superior to that required by the Standards; and

(3) Where (i) compliance with the Standards would be unreasonable because of the circumstances of the particular case, or (ii) the alternative construction would be for purposes of research, testing or development of new techniques or designs. If a request for alternative construction is submitted and the facts are consistent with these principles, the Secretary may issue a letter under paragraph (c) of this section stating that no action will be taken under the Act based upon specific failures to conform to the Standards or these regulations, provided that certain conditions are met. The issuance of a letter under paragraph (c) of this section will not affect any right that any purchaser may have under the Act or other applicable law and will not preclude any further agency action that may become necessary.

(b) *Request for alternative construction.* A manufacturer may submit a request for alternative construction of a manufactured home. The request should be sent to the U.S. Department of Housing and Urban Development, Manufactured Housing Standards Division, 451 Seventh Street, SW., Washington, DC 20410. The request must include:

(1) A copy of the manufactured design or plan for each nonconforming model which a manufacturer plans to build;

(2) An explanation of the manner in which the design fails to conform with the Standards, including a list of the specific standards involved;

(3) An explanation of how the design will result in homes that provide the same level of performance, quality, durability and safety as would be provided under the Standards;

(4) A copy of data adequate to support the request, including applicable test data, engineering calculations or certifications from nationally recognized laboratories;

(5) An estimate of the maximum number of manufactured home units affected and the location, if known, to which the units will be shipped;

(6) An indication of the period of time during which the manufacturer

proposes to engage in the manufacture, sale or lease of the nonconforming homes;

(7) A copy of the proposed notice to be provided to home purchasers;

(8) A list of the names and addresses of any dealers that would be selling the nonconforming homes; and

(9) A letter from the manufacturer's DAPIA indicating that the design(s) to which any nonconforming homes would be built meet the Standards in all other respects.

(c) *Issuance of the letter by the Secretary—(1) Contents of the letter.* If the Secretary issues a letter in response to a request for alternative construction, the letter shall include the specific standards affected, an explanation of the proposed activity or design, an explanation of how the request is consistent with the objectives of the Act, and any conditions that the manufacturer must meet.

(2) *Letter sent to IPIA, DAPIA and SAA.* The Secretary shall forward a copy of the letter to the manufacturer's IPIA and DAPIA along with a letter authorizing the DAPIA to approve plans containing the alternative construction, and authorizing the IPIA to permit use of the alternative construction, provided that the conditions set forth in the letter are met. The Secretary shall also forward a copy of the letter to the SAAs in the State of manufacture and the State(s) in which the homes are to be located, if known.

(3) *Alternative construction in additional models.* In cases where the Secretary grants a letter under this paragraph that is not model-specific, the Secretary may permit the manufacturer to include the alternative construction in additional models. In such cases, the DAPIA shall notify the Department of additional models that incorporate the alternative construction.

(d) *Revocation.* The Secretary may revoke or amend a letter issued under paragraph (c) of this section at any time. Such revocation or amendment will be prospective only. Where manufacturers have requested alternative construction for research, testing or development such alternative construction may not achieve the anticipated results. Therefore, the Secretary may require a manufacturer to bring

those homes into compliance with the standards if, after the alternative construction has been in use for a period of time specified by the Secretary, these homes are not, in the Secretary's judgment, providing the levels of safety, quality and durability which would have been provided had the homes been built in compliance with the Standards.

(e) *Notice to prospective purchasers.* Manufacturers receiving letters under paragraph (c) of this section shall provide notice to prospective purchasers that the home does not conform to the Standards. Such notice shall be delivered to each prospective purchase before he or she enters into an agreement to purchase the home. The notice shall be in the following form or in such other form as may be approved by the Secretary:

NOTICE TO PURCHASERS

The Department of Housing and Urban Development has issued a letter to (Name of Manufacturer) concerning the homes in (location if known). As designed, the homes do not meet Federal Manufactured Home Construction and Safety Standards regarding (brief statement of manufacturer's non-conformance).

HUD has evaluated the alternative construction and believes that it provides an equivalent level of quality, durability and safety to that provided by the Standards.

For further information about the specific Federal Standards involved, a copy of the letter issued pursuant to 24 CFR 3282.14(c) is available from this dealer or manufacturer upon request.

(f) *Serial numbers of homes constructed using alternative construction.* Manufacturers shall provide the Department with the serial numbers assigned to each home produced in conformance with the letter issued under paragraph (c) of this section within 90 days of their date of manufacture. Each serial number shall include the letters "AC" to indicate that the homes was produced under alternative construction procedures.

[49 FR 1967, Jan. 16, 1984]

Subpart B—Formal Procedures

§ 3282.51 Scope.

This subpart contains rules of procedure generally applicable to the transaction of official business under the National Manufactured Housing Construction and Safety Standards Act, including the rules governing public availability of information.

§ 3282.52 Address of communications.

Unless otherwise specified, communications shall be addressed to the Director, Manufactured Housing Standards Division, Department of Housing and Urban Development, 451 Seventh Street, SW., Washington, DC 20410.

§ 3282.53 Service of process on foreign manufacturers and importers.

The designation of an agent required by section 612(e) of the Act, 42 U.S.C. 5411(e), shall be in writing, dated, and signed by the manufacturer and the designated agent.

[61 FR 10860, Mar. 15, 1996]

§ 3282.54 Public information.

(a) *General.* Subject to the provisions of 24 CFR part 15 covering the production or disclosure of material or information and the provisions of 24 CFR part 16 at 40 FR 39729 relating to the Privacy Act, and except as otherwise provided by paragraphs (b), (c), (d), and (e) of this section, the Secretary may make available to the public:

(1) Any information which may indicate the existence of an imminent safety hazard, and

(2) Any information which may indicate the failure of a manufactured home to comply with applicable manufactured home construction and safety standards, and

(3) Such other information as the Secretary determines is necessary to carry out the Secretary's functions under the Act.

(b) *Protected information.* Data and information submitted or otherwise provided to the Secretary or an agent of the Secretary or a PIA or SAA which fall within the definitions of a trade secret or confidential commercial or financial information are exempt from disclosure under this section, only if

§ 3282.101

the party submitting or providing the information so requests under paragraph (c) of this section. However, the Secretary may disclose such information to any person requesting it after deletion of the portions which are exempt, or in such combined or summary form as does not disclose the portions which are exempt from disclosure or in its entirety in accordance with section 614 of the Act, U.S.C. 5413.

(c) *Obtaining exemption.* Any party submitting any information to the Secretary in any form under this part, or otherwise in relation to the program established by the Act shall, if the party desires the information to be exempt from disclosure, at the time of submittal of the information or at any time thereafter, request that the information or any part thereof be protected from disclosure. The request for nondisclosure shall include the basis for the request under the Act or other authority and complete justification supporting the claim that the material should be exempt from disclosure. The request should also include a statement of the information in such combined or summary form that alleged trade secrets or other protected information and the identity of the submitting party would not be disclosed. This request need not be made with respect to information which was submitted to the Secretary, an SAA or a PIA prior to the effective date of these regulations.

(d) *Request for information from PIAs or SAAs.* Whenever a PIA or SAA receives requests for disclosure of information, it shall disclose the information unless the party from which the information was originally obtained has submitted to the PIA or SAA a request that the information not be disclosed under paragraph (c) of this section, except that the PIA or SAA shall be governed by the provisions of 24 CFR part 16 (40 FR 39729) relating to the Privacy Act which may limit the disclosure of information. If a request for nondisclosure under paragraph (c) of this section has been received with respect to information whose disclosure is requested, the PIA or SAA shall refer the matter to the Secretary within 5 days of the request for disclosure. If a PIA or SAA receives a request for

24 CFR Ch. XX (4-1-11 Edition)

disclosure of information related to this program, which information was submitted to the PIA or SAA prior to the effective date of these regulations, the PIA or SAA shall refer the request for nondisclosure and required information to the Secretary.

[41 FR 19852, May 13, 1976, as amended at 61 FR 10860, Mar. 15, 1996]

Subpart C—Rules and Rulemaking Procedures

§ 3282.101 Generally.

Procedures that apply to the formulation, issuance, amendment, and revocation of rules pursuant to the Act are governed by the Act, the Administrative Procedure Act, 5 U.S.C. 551 *et seq.*, and part 10 of this title, except that the Secretary shall respond to a petition for rulemaking by an interested party within 180 days of receipt of the petition.

[61 FR 10860, Mar. 15, 1996]

§ 3282.111 Petitions for reconsideration of final rules.

(a) *Definition.* A petition for reconsideration of a final rule issued by the Secretary is a request in writing from any interested person which must be received not later than 60 days after publication of the rule in the FEDERAL REGISTER. The petition shall state that it is a petition for reconsideration of a final rule, and shall contain an explanation as to why compliance with the rule is not practicable, is unreasonable, or is not in the public interest. If the petitioner requests the consideration of additional facts, the petitioner shall state the reason they were not presented to be treated as petitions for rulemaking.

(b) *Proceedings on petitions for reconsideration.* The Secretary may grant or deny, in whole or in part, any petition for reconsideration without further proceedings. The Secretary may issue a final decision on reconsideration without further proceeding, or may provide such opportunity to submit comments or information and data as the Secretary deems appropriate.

(c) Unless the Secretary determines otherwise, the filing of a petition under

this section does not stay the effectiveness of the rule in question.

(d) Any party seeking to challenge any rule or regulation issued under the Act, except orders issued under section 604 42 U.S.C. 5403, if the challenge is brought before the expiration of the 60 day period set out in paragraph (a) of this section, shall file a timely petition for reconsideration under this section prior to seeking any other remedy.

§ 3282.113 Interpretative bulletins.

When appropriate, the Secretary shall issue interpretative bulletins interpreting the standards under the authority of § 3280.9 of this chapter or interpreting the provisions of this part. Issuance of interpretative bulletins shall be treated as rulemaking under this subpart C unless the Secretary deems such treatment not to be in the public interest and the interpretation is not otherwise required to be treated as rulemaking. All interpretative bulletins shall be indexed and made available to the public at the Manufactured Housing Standards Division and a copy of the index shall be published periodically in the FEDERAL REGISTER.

[61 FR 10860, Mar. 15, 1996]

Subpart D—Informal and Formal Presentations of Views, Hearings and Investigations

§ 3282.151 Applicability and scope.

(a) This subpart sets out procedures to be followed when an opportunity to present views provided for in the Act is requested by an appropriate party. Section 3282.152 provides for two types of procedures that may be followed, one informal and nonadversary, and one more formal and adversary. Section 3282.152 also sets out criteria to govern which type of procedure will be followed in particular cases.

(b) The procedures of § 3282.152 also apply to:

(1) Proceedings held by the Secretary whenever the suspension or disqualification of a primary inspection agency, which has been granted final approval, is recommended under § 3282.356 of these regulations, and

(2) Resolution of disputes where an SAA or manufacturer disagrees with a

determination of a DAPIA under § 3282.361 that a manufactured home design does or does not conform to the standards or that a quality assurance manual is or is not adequate with a decision by an IPIA to red tag or not to red tag or to provide or not to provide a certification label for a manufactured home under § 3282.362 when the IPIA believes that the manufactured home does or does not conform to the standards.

(c) The procedures set out in § 3282.152 shall also be followed whenever State Administrative Agencies hold Formal or Informal Presentations of Views under § 3282.309.

(d) To the extent that these regulations provide for Formal or Informal Presentations of Views for parties that would otherwise qualify for hearings under 2 CFR part 2424, the procedures of 2 CFR part 2424 shall not be available and shall not apply.

[41 FR 19852, May 13, 1976, as amended at 51 FR 34467, Sept. 29, 1986; 61 FR 10442, Mar. 13, 1996; 72 FR 73497, Dec. 27, 2007]

§ 3282.152 Procedures to present views and evidence.

(a) *Policy.* All Formal and Informal Presentations of Views under this subpart shall be public, unless, for good cause, the Secretary determines it is in the public interest that a particular proceeding should be closed. If the Secretary determines that a proceeding should be closed, the Secretary shall state and make publicly available the basis for that determination.

(b) *Request.* Upon receipt of a request to present views and evidence under the Act, the Secretary shall determine whether the proceeding will be a Formal or an Informal Presentation of Views, and shall issue a notice under paragraph (c) of this section.

(c) *Notice.* When the Secretary decides to conduct a Formal or an Informal Presentation of Views under this section, the Secretary shall provide notice as follows:

(1) Except where the need for swift resolution of the question involved prohibits it, notice of a proceeding hereunder shall be published in the FEDERAL REGISTER at least 10 days prior to the date of the proceeding. In any case, notice shall be provided to interested

persons to the maximum extent practicable. Direct notice shall be sent by certified mail to the parties involved in the hearing.

(2) The notice, whether published or mailed, shall include a statement of the time, place and nature of the proceeding; reference to the authority under which the proceeding will be held; a statement of the subject matter of the proceeding, the parties and issues involved; and a statement of the manner in which interested persons shall be afforded the opportunity to participate in the hearing.

(3) The notice shall designate the official who shall be the presiding officer for the proceedings and to whom all inquiries should be directed concerning such proceedings.

(4) The notice shall state whether the proceeding shall be held in accordance with the provisions of paragraph (f)—(Informal Presentation of Views) or paragraph (g)—(Formal Presentation of Views) of this section, except that when the Secretary makes the determinations provided for in sections 623 (d) and (f) of the Act, the requirements of paragraph (g) of this section shall apply. In determining whether the requirements of paragraph (f) or those of paragraph (g) of this section shall apply the Secretary shall consider the following:

- (i) The necessity for expeditious action;
- (ii) The risk of injury to affected members of the public;
- (iii) The economic consequences of the decisions to be rendered; and
- (iv) Such other factors as the Secretary determines are appropriate.

(d) *Department representative.* If the Department is to be represented by Counsel, such representation shall be by a Department hearing attorney designated by the General Counsel.

(e) *Reporting and transcription.* Oral proceedings shall be stenographically or mechanically reported and transcribed under the supervision of the presiding officer, unless the presiding officer and the parties otherwise agree, in which case a summary approved by the presiding officer shall be kept. The original transcript or summary shall be a part of the record and the sole official transcript, or summary. A copy of

the transcript or summary shall be available to any person at a fee established by the Secretary, which fee the Secretary may waive in the public interest. Any information contained in the transcript or summary which would be exempt from required disclosure under § 3282.54 of these regulations may be protected from disclosure if appropriate under that section upon a request for such protection under § 3282.54(c).

(f) *Informal presentation of views.* (1) An Informal Presentation of Views may be written or oral, and may include an opportunity for an oral presentation, whether requested or not, whenever the Secretary concludes that an oral presentation would be in the public interest, and so states in the notice. A presiding officer shall preside over all oral presentations held under this subsection. The purpose of any such presentation shall be to gather information to allow fully informed decision making. Informal Presentations of Views shall not be adversary proceedings. Oral presentations shall be conducted in an informal but orderly manner. The presiding officer shall have the duty and authority to conduct a fair proceeding, to take all necessary action to avoid delay, and to maintain order. In the absence of extraordinary circumstances, the presiding officer at an oral Informal Presentation of Views shall not require that testimony be given under an oath or affirmation, and shall not permit either cross-examination of witnesses by other witnesses or their representatives, or the presentation of rebuttal testimony by persons who have already testified. The rules of evidence prevailing in courts of law or equity shall not control the conduct of oral Informal Presentations of Views.

(2) Within 10 days after an Informal Presentation of Views, the presiding officer shall refer to the Secretary all documentary evidence submitted, the transcript, if any, a summary of the issues involved and information presented in the Informal Presentation of Views and the presiding official's recommendations, with the rationale therefor. The presiding officer shall

make any appropriate statements concerning the apparent veracity of witnesses or the validity of factual assertions which may be within the competence of the presiding officer. The Secretary shall issue a Final Determination concerning the matters at issue within 30 days of receipt of the presiding officer's summary. The Final Determination shall include:

(i) A statement of findings, with specific references to principal supporting items of evidence in the record and conclusions, as well as the reasons or bases therefor, upon all of the material issues of fact, law, or discretion as presented on the record, and

(ii) An appropriate order. Notice of the Final Determination shall be given in writing and transmitted by certified mail, return receipt requested, to all participants in the presentation of views. The Final Determination shall be conclusive, with respect to persons whose interests were represented.

(g) *Formal presentation of views.* (1) A Formal Presentation of Views is an adversary proceeding and includes an opportunity for the oral presentation of evidence. All witnesses shall testify under oath or affirmation, which shall be administered by the presiding officer. Participants shall have the right to present such oral or documentary evidence and to conduct such cross-examination as the presiding officer determines is required for a full and true disclosure of facts. The presiding officer shall receive relevant and material evidence, rule upon offers of proof and exclude all irrelevant, immaterial or unduly repetitious evidence. However, the technicalities of the rules of evidence prevailing in courts of law or equity shall not control the conduct of a Formal Presentation of Views. The presiding officer shall take all necessary action to regulate the course of the Formal Presentation of Views to avoid delay and to maintain order. The presiding officer may exclude the attorney or witness from further participation in the particular Formal Presentation of Views and may render a decision adverse to the interests of the excluded party in his absence.

(2) *Decision.* The presiding officer shall make and file an initial written decision on the matter in question. The

decision shall be filed within 10 days after completion of the oral presentation. The decision shall include:

(i) A statement of findings of fact, with specific references to principal supporting items of evidence in the record and conclusions, as well as the reasons or bases therefor, upon all of the material issues of law or discretion presented on the record, and

(ii) An appropriate order.

The presiding officer's decision shall be final and shall constitute the Final Determination of the Secretary unless reversed or modified within 30 days by the Secretary. Notice of the Final Determination shall be given in writing, and transmitted by registered or certified mail, return receipt requested, to all participants in the proceeding. The Final Determination shall be conclusive with respect to persons whose interests were represented.

[41 FR 19852, May 13, 1976, as amended at 51 FR 34467, Sept. 29, 1986]

§ 3282.153 Public participation in formal or informal presentation of views.

(a) Any interested persons may participate, in writing, in any Formal or Informal Presentation of Views held under the provisions of paragraph (f) or (g) of § 3282.152. The presiding officer shall, to the extent practicable, consider any such written materials.

(b) Any interested person may participate in the oral portion of any Formal or Informal Presentation of Views held under paragraphs (f) and (g) of § 3282.152 unless the presiding officer determines that participation should be limited or barred so as not unduly to prejudice the rights of the parties directly involved or unnecessarily to delay the proceedings.

[51 FR 34468, Sept. 29, 1986]

§ 3282.154 Petitions for formal or informal presentations of views, and requests for extraordinary interim relief.

Any person entitled to a Formal or an Informal Presentation of Views under paragraph (f) or paragraph (g) of § 3282.152 in order to address issues as provided for in § 3282.151(a) may petition the Secretary to initiate such a Presentation of Views. The petition

§ 3282.155

may be accompanied by a request that the Secretary provide appropriate interim relief pending the issuance of the final determination or decision. No interim relief will be granted unless there is a showing of extraordinary cause. Upon receipt of a petition, the Secretary shall grant the petition and issue the notice provided for in § 3282.152(b) for Formal or Informal Presentation of Views, and may grant, deny or defer decision on any request for interim relief.

[51 FR 34468, Sept. 29, 1986]

§ 3282.155 Investigations.

The procedures for investigations and investigational proceedings are set forth in part 3800 of this chapter.

[61 FR 10442, Mar. 13, 1996]

§ 3282.156 Petitions for investigations.

(a) Any person may petition the Secretary in writing to open an investigation into whether noncompliances, defects, serious defects, or imminent safety hazards exist in manufactured homes. A petition shall include the reasons that the petitioner believes warrant an investigation, and it shall state any steps which have previously been taken to remedy the situation. The petition shall include all information known to the petitioner concerning the identity of manufactured homes which may be affected and where those manufactured homes were manufactured. The Secretary shall respond to petitions concerning alleged imminent safety hazards and serious defects within 60 days and to petitions alleging the existence of defects or noncompliances within 120 days.

(b) Any person may petition the Secretary in writing to undertake an investigation for the purpose of determining whether a primary inspection agency should be disqualified. The petition shall set out all facts and information on which the petition is based and a detailed statement of why such information justifies disqualification. The Secretary shall consider such petitions when making determinations on final acceptance and continued acceptance. The Secretary shall respond to such petition within 120 days.

24 CFR Ch. XX (4–1–11 Edition)

Subpart E—Manufacturer Inspection and Certification Requirements

§ 3282.201 Scope and purpose.

(a) This subpart sets out requirements which must be met by manufacturers of manufactured homes for sale to purchasers in the United States with respect to certification of manufactured home designs, inspection of designs, quality assurance programs, and manufactured home production, and certification of manufactured homes. Other than references and a general description of responsibilities, this subpart does not set out requirements with respect to remedial actions or reports which must be taken or filed under the Act and these regulations.

(b) The purpose of this subpart is to require manufacturers to participate in a system of design approvals and inspections which serve to assist them in assuring that manufactured homes which they manufacture will conform to Federal standards. Such approvals and inspections provide significant protection to the public by decreasing the number of manufactured homes with possible defects in them, and provide protection to manufacturers by reducing the number of instances in which costly remedial actions must be undertaken after manufactured homes are sold.

§ 3282.202 Primary inspection agency contracts.

Each manufacturer shall enter into a contract or other agreement with as many Design Inspection Primary Inspection Agencies (DAPIAs) as it wishes and with enough Production Inspection Primary Inspection Agencies (IPIAs) to provide IPIA services for each manufacturing plant as set out in this subpart and in subpart H of this part. In return for the services provided by the DAPIAs and IPIAs, each manufacturer shall pay such reasonable fees as are agreed upon between the manufacturer and the primary inspection agency or, in the case of a State acting as an exclusive IPIA under § 3282.3 such fees as may be established by the State.

§ 3282.203 DAPIA services.

(a) Each manufacturer shall have each manufactured home design and each quality assurance manual which it intends to follow approved by a DAPIA under § 3282.361. The manufacturer is free to choose which DAPIA will evaluate and approve its designs and quality assurance materials manufacturer may obtain design and quality assurance manual approval from a single DAPIA regardless of the number of plants in which the design and quality assurance manual will be followed. A manufacturer may also obtain approval for the same design and quality assurance manual from more than one DAPIA. The choice of which DAPIA or DAPIAs to employ is left to the manufacturer.

(b) The manufacturer shall submit to the DAPIA such information as the DAPIA may require in order to carry out design approvals. This information shall, except where the manufacturer demonstrates to the DAPIA that it is not necessary, include the following:

(1) Construction drawings and/or specifications showing structural details and layouts of frames, floors, walls and roofs, and chassis; material specifications, framing details, door locations, etc., for each floor plan proposed to be manufactured,

(2) Structural analysis and calculations, test data and/or other accepted engineering practices used by the manufacturer to validate the design,

(3) Complete heat loss calculations for each significant variation of home design,

(4) Floor plans showing room arrangement and sizes, window sizes, emergency exits and locations, locations of smoke alarms, fixed appliance range hoods, and other standards related aspects of the manufactured home that can be shown on the floor plans,

(5) Diagrams of the fuel supply system, potable water system and drain, waste and vent systems. The diagrams shall specify the types of materials used, types of fittings and methods of installing required safety equipment,

(6) Wiring diagrams, including circuit allocation of electrical load and branch circuit calculations, a table of the branch circuit protection provided, the

type of wiring used, and wiring methods,

(7) Details showing the design of air supply and return systems,

(8) Details of chassis construction, components, connections and running gear including rating capacities of tires,

(9) A list of fixed and portable appliances furnished with the manufactured home, including type of appliance, rating of appliance, and applicable minimum and maximum performance ratings and/or energy requirements,

(10) Detailed manufacturer installation instructions including specifications and procedures for the erection and hook-up of the home at its permanent location, and

(11) Reports of all tests that were run to validate the conformance of the design to the standards.

(c) The manufacturer shall submit to the DAPIA such information as the DAPIA may require in order to carry out quality assurance manual approvals. At a minimum, this information shall include the quality assurance manual for which approval is sought. That manual shall include the manufacturer's quality assurance program, an organizational chart showing the accountability, by position, of the manufacturer's quality control personnel, a description of production tests and test equipment required for compliance with the standards, a station-by-station description of the manufacturing process, a list of quality control inspections required by the manufacturer at each station, and identification by title of each person who will be held accountable for each quality control inspection.

(d) Manufacturers may be required to furnish supplementary information to the DAPIA if the design information or the quality assurance manual is not complete or if any information is not in accordance with accepted engineering practice.

(e) When a manufacturer wishes to make a change in an approved design or quality assurance manual, the manufacturer shall obtain the approval of the DAPIA which approved the design or manual prior to production for sale. The procedures for obtaining such approval are set out in § 3282.361.

§ 3282.204

(f) The information to be submitted to a DAPIA under §3282.203 (b) and (c) may be prepared by the manufacturer's staff or outside consultants, including other DAPIAs. However, a DAPIA may not perform design or quality assurance manual approvals for any manufacturer whose design or manual has been created or prepared in whole or in part by members of the DAPIA's organization or of any affiliated organization.

(g) Each manufacturer shall maintain a copy of the drawings, specifications, and sketches from each approved design received from a DAPIA under §3282.361(b)(4) in each plant in which manufactured homes are being produced to the design. Each manufacturer shall also maintain in each manufacturing plant a copy of the approved quality assurance manual received from a DAPIA under §3282.361(c)(3) that is being followed in the plant. These materials shall be kept current and shall be readily accessible for use by the Secretary or other parties acting under these regulations.

[41 FR 19852, May 13, 1976, as amended at 67 FR 12818, Mar. 19, 2002]

§ 3282.204 IPIA services.

(a) Each manufacturer shall obtain the services of an IPIA as set out in §3282.362 for each manufacturing plant operated by the manufacturer.

(b) The manufacturer shall make available to the IPIA operating in each of its plants a copy of the drawings and specifications from the DAPIA approved design and the quality assurance manual for that plant, and the IPIA shall perform an initial factory inspection as set out in §3282.362(b). If the IPIA issues a deviation report after the initial factory inspection, the manufacturer shall make any corrections or adjustments which are necessary to conform with the DAPIA approved designs and manuals. After the corrections required by the deviation report are completed to the satisfaction of the IPIA, the IPIA shall issue the certification report as described in §3282.362(b)(2). In certain instances a DAPIA may provide the certification report. (See §3282.362) The manufacturer shall maintain a current copy of each certification report in the plant

24 CFR Ch. XX (4-1-11 Edition)

to which the certification report relates.

(c) After the certification report has been signed by the IPIA, the manufacturer shall obtain labels from the IPIA and shall affix them to completed manufactured homes as set out in §3282.362(c)(2). During the initial factory certification, the IPIA may apply labels to manufactured homes which it knows to be in compliance with the standards if it is performing complete inspections of all phases of production of each manufactured home and the manufacturer authorizes it to apply labels.

(d) During the course of production the manufacturer shall maintain a complete set of approved drawings, specifications, and approved design changes for the use of the IPIA's inspector and always available to that inspector when in the manufacturing plant.

(e) If, during the course of production, an IPIA finds that a failure to conform to a standard exists in a manufactured home in production, the manufacturer shall correct the failure to conform in any manufactured homes still in the factory and held by distributors or dealers and shall carry out remedial actions under §§3282.404 and 3282.405 with respect to any other manufactured homes which may contain the same failure to conform.

§ 3282.205 Certification requirements.

(a) Every manufacturer shall make a record of the serial number of each manufactured home produced, and a duly authorized representative of the manufacturer shall certify that each manufactured home has been constructed in accordance with the Federal standards. The manufacturer shall furnish a copy of that certification to the IPIA for the purpose of determining which manufactured homes are subject to the notification and correction requirements of subpart I of this part.

(b) Every manufacturer of manufactured homes shall certify on the data plate as set out in §3280.5 of chapter XX of 24 CFR and §3282.362(c)(3) that the manufactured home is designed to comply with the Federal manufactured

home construction and safety standards in force at the time of manufacture in addition to providing other information required to be completed on the data plate.

(c) Every manufacturer of manufactured homes shall furnish to the dealer or distributor of each of its manufactured homes a certification that such manufactured home, to the best of the manufacturer's knowledge and belief, conforms to all applicable Federal construction and safety standards. This certification shall be in the form of the label provided by the IPIA under § 3282.362(c)(2). The label shall be affixed only at the end of the last stage of production of the manufactured home.

(d) The manufacturer shall apply a label required or allowed by the regulations in this part only to a manufactured home that the manufacturer knows by its inspections to be in compliance with the standards.

[41 FR 19852, May 13, 1976, as amended at 41 FR 24970, June 21, 1976; 61 FR 10860, Mar. 15, 1996]

§ 3282.206 Disagreement with IPIA or DAPIA.

Whenever a manufacturer disagrees with a finding by a DAPIA or an IPIA acting in accordance with subpart H of this part, the manufacturer may request a Formal or Informal Presentation of Views as provided in § 3282.152. The manufacturer shall not, however, produce manufactured homes pursuant to designs which have not been approved by a DAPIA or produce manufactured homes which the relevant IPIA believes not to conform to the standards unless and until:

(a) The Secretary determines that the manufacturer is correct in believing the design of the manufactured home conforms to the standards; or

(b) Extraordinary interim relief is granted under § 3282.154; or

(c) The DAPIA or IPIA otherwise resolves the disagreement.

[41 FR 19852, May 13, 1976, as amended at 51 FR 34468, Sept. 29, 1986; 61 FR 10860, Mar. 15, 1996]

§ 3282.207 Manufactured home consumer manual requirements.

(a) The manufacturer shall provide a consumer manual with each manufactured home that enters the first stage of production on or after July 31, 1977, pursuant to section 617 of the National Manufactured Housing Construction and Safety Standards Act, 42 U.S.C. 5416.

(b) The manufacturer shall provide the consumer manual by placing a manual in each such manufactured home before the manufactured home leaves the manufacturing plant. The manual shall be placed in a conspicuous location in a manner likely to assure that it is not removed until the purchaser removes it.

(c) If a manufacturer is informed that a purchaser did not receive a consumer manual, the manufacturer shall provide the appropriate manual to the purchaser within 30 days of being so informed.

(d) No dealer or distributor may interfere with the distribution of the consumer manual. When necessary, the dealer or distributor shall take any appropriate steps to assure that the purchaser receives a consumer manual from the manufacturer.

(e) *Dispute resolution information.* (1) The manufacturer must include the following language under a heading of "Dispute Resolution Process" in the consumer manual:

Many states have a consumer assistance or dispute resolution program that homeowners may use to resolve problems with manufacturers, retailers, or installers concerning defects in their manufactured homes that render part of the home unfit for its intended use. Such state programs may include a process to resolve a dispute among a manufacturer, a retailer, and an installer about who will correct the defect. In states where there is not a dispute resolution program that meets the federal requirements, the HUD Manufactured Home Dispute Resolution Program will operate. These are "HUD-administered states." The HUD Manufactured Home Dispute Resolution Program is not for cosmetic or minor problems in the home. You may contact the HUD Manufactured Housing Program Office at (202) 708-6423 or (800) 927-2891, or visit the HUD website at www.hud.gov to determine whether your state has a state program or whether you should use the HUD Manufactured Home

Dispute Resolution Program. Contact information for state programs is also available on the HUD website. If your state has a state program, please contact the state for information about the program, how it operates, and what steps to take to request dispute resolution. When there is no state dispute resolution program, a homeowner may use the HUD Manufactured Home Dispute Resolution Program to resolve disputes among the manufacturer, retailer, and installer about responsibility for the correction or repair of defects in the manufactured home that were reported during the 1-year period starting on the date of installation. Even after the 1-year period, manufacturers have continuing responsibility to review certain problems that affect the intended use of the manufactured home or its parts, but for which correction may no longer be required under federal law.

(2) The manufacturer must include the following language under a heading of “Additional Information “ HUD Manufactured Home Dispute Resolution Program” in the consumer manual:

The steps and information outlined below apply only to the HUD Manufactured Home Dispute Resolution Program that operates in HUD-administered states, as described under the heading “Dispute Resolution Information” in this manual. Under the HUD Manufactured Home Dispute Resolution Program, homeowners must report defects to the manufacturer, retailer, installer, a State Administrative Agency, or HUD within 1 year after the date of the first installation. Homeowners are encouraged to report defects in writing, including, but not limited to, email, written letter, certified mail, or fax, but they may also make a report by telephone. To demonstrate that the report was made within 1 year after the date of installation, homeowners should report defects in a manner that will create a dated record of the report: for example, by certified mail, by fax, or by email. When making a report by telephone, homeowners are encouraged to make a note of the phone call, including names of conversants, date, and time. No particular format is required to submit a report of an alleged defect, but any such report should at a minimum include a description of the alleged defect, the name of the homeowner, and the address of the home.

Homeowners are encouraged to send reports of an alleged defect first to the manufacturer, retailer, or installer of the manufactured home, or a State Administrative Agency. Reports of alleged defects may also be sent to HUD at: HUD, Office of Regulatory Affairs and Manufactured Housing, Attn: Dispute Resolution, 451 Seventh Street, SW., Washington, DC 20410-8000; faxed to (202) 708-

4213; e-mailed to *mhs@hud.gov*, or reported telephonically at (202) 708-6423 or (800) 927-2891.

If, after taking the steps outlined above, the homeowner does not receive a satisfactory response from the manufacturer, retailer, or installer, the homeowner may file a dispute resolution request with the dispute resolution provider in writing, or by making a request by phone. No particular format is required to make a request for dispute resolution, but the request should generally include the following information:

- (1) The name, address, and contact information of the homeowner;
- (2) The name and contact information of the manufacturer, retailer, and installer of the manufactured home;
- (3) The date or dates the report of the alleged defect was made;
- (4) Identification of the entities or persons to whom each report of the alleged defect was made and the method that was used to make the report;
- (5) The date of installation of the manufactured home affected by the alleged defect; and
- (6) A description of the alleged defect.

Information about the dispute resolution provider and how to make a request for dispute resolution is available at *http://www.hud.gov* or by contacting the Office of Manufactured Housing Programs at (202) 708-6423 or (800) 927-2891.

A screening agent will review the request and, as appropriate, forward the request to the manufacturer, retailer, installer, and mediator. The mediator will mediate the dispute and attempt to facilitate a settlement. The parties to a settlement include, as applicable, the manufacturer, retailer, and installer. If the parties are unable to reach a settlement that results in correction or repair of the alleged defect, any party or the homeowner may request nonbinding arbitration. Should any party refuse to participate, the arbitration shall proceed without that party's input. Once the arbitrator makes a non-binding recommendation, the arbitrator will forward it to the parties and HUD. HUD will have the option of adopting, modifying, or rejecting the recommendation when issuing an order requiring the responsible party or parties to make any corrections or repairs in the home. At any time before HUD issues a final order, the parties may submit an offer of settlement to HUD that may, at HUD's discretion, be incorporated into the order.

In circumstances where the parties agree that one or more of them, and not the homeowner, is responsible for the alleged defect, the parties will have the opportunity to resolve the dispute outside of the HUD Mediation and Arbitration process by using the Alternative Process. Homeowners will maintain the right to be informed in writing of

the outcome when the Alternative Process is used, within 5 days of the outcome. At any time after 30 days of the Alternative Process notification, any participant or the homeowner may invoke the HUD Manufactured Home Dispute Resolution Program and proceed to mediation.

The HUD Manufactured Home Dispute Resolution Program is not a warranty program and does not replace the manufacturer's or any other warranty program.

(f) If a consumer manual or a change or revision to a manual does not substantially comply with the guidelines issued by HUD, the manufacturer shall cease distribution of the consumer manual and shall provide a corrected manual for each manufactured home for which the inadequate or incorrect manual or revision was provided. A manual substantially complies with the guidelines if it includes the language in paragraph (e) of this section and presents current material on each of the subjects covered in the guidelines in sufficient detail to inform consumers about the operation, maintenance, and repair of manufactured homes. An updated copy of guidelines published in the FEDERAL REGISTER on March 15, 1996, can be obtained by contacting the Office of Manufactured Housing and Regulatory Functions, Department of Housing and Urban Development, 451 Seventh Street, SW., Washington, DC, 20410; the Information Center, Department of Housing and Urban Development, Room 1202, 451 Seventh Street, SW., Washington, DC, 20410; or any HUD Area or State Office.

[61 FR 10860, Mar. 15, 1996, as amended at 72 FR 27228, May 14, 2007]

§ 3282.208 Remedial actions—general description.

(a) *Notification.* A manufacturer may be required to provide formal notice to manufactured home owners and dealers, as set out in subpart I of this part, if the manufacturer, the Secretary, or a State Administrative Agency determines under that subpart that an imminent safety hazard, serious defect, defect, or noncompliance exists or may exist in a manufactured home produced by that manufacturer.

(b) *Correction.* A manufacturer may be required to correct imminent safety hazards and serious defects which the manufacturer or the Secretary deter-

mines under subpart I exist in manufactured homes produced by the manufacturer. This correction would be carried out in addition to the sending of formal notice as described in paragraph (a) of this section.

(c) *Cooperation.* The manufacturer shall be responsible for working with the DAPIA, IPIA, any SAA, the Secretary, and the Secretary's agent as necessary in the course of carrying out investigations and remedial actions under subpart I.

(d) *Avoidance of formalities.* The provisions for notification and required correction outlined in paragraphs (a) and (b) of this section and described more fully in subpart I may be waived or avoided in certain circumstances under that subpart.

§ 3282.209 Report requirements.

The manufacturer shall submit reports to the PIAs, SAAs, and the Secretary as required by subpart L of these regulations.

§ 3282.210 Payment of monitoring fee.

(a) Each manufacturer shall pay the monitoring fee established under §§ 3282.307 and 3282.454 for each transportable section of each manufactured housing unit that it manufactures under the Federal standards.

(b) The monitoring fee shall be paid in the form of a check made payable to the Secretary or the Secretary's agent. The manufacturer shall give to the IPIA (or to any other person or agency designated in writing by the Secretary) the required check in the amount of the number of labels, as required by § 3282.365, multiplied by the amount of the fee per transportable section of each manufactured housing unit.

[50 FR 28398, July 12, 1985]

§ 3282.211 Record of purchasers.

(a) *Information requirements for purchasers.* (1) Every manufacturer of manufactured homes shall, for each manufactured home manufactured under the Federal standards, provide with the manufactured home a booklet containing at least 3 detachable cards as described in paragraph (a)(2) of this section. On the front of the booklet, in

§ 3282.251

bold faced type, shall be printed the following language:

“Keep this booklet with your manufactured home. Title VI of the Housing and Community Development Act of 1974 provides you with protection against certain construction and safety hazards in your manufactured home. To help assure your protection, the manufacturer of your manufactured home needs the information which these cards, when completed and mailed, will supply. If you bought your home from a dealer, please be sure that your dealer has completed and mailed a card for you. If you acquired your home from someone who is not a dealer, you should promptly fill out and send a card to the manufacturer. It is important that you keep this booklet and give it to any person who buys the manufactured home from you.”

(2) The detachable cards shall contain blanks for the following information:

- (i) Name and address of the dealer or other person selling the manufactured home to the purchaser;
- (ii) Name and complete mailing address of the manufactured home purchaser;
- (iii) Address where the manufactured home will be located, if not the same as item (a)(2)(ii) of this section.
- (iv) Date of sale to the purchaser;
- (v) Month, day and year of manufacture;
- (vi) Identification number of the manufactured home;
- (vii) Model and/or type designation of the manufactured home as provided by the manufacturer; and
- (viii) A designation of the zones for which the manufactured home is equipped, as set forth in §3280.305 in this title.

Additionally, the cards shall have the name and address of the manufacturer printed clearly on the reverse side and shall contain adequate postage or business reply privileges to ensure return to the manufacturer. The manufacturer shall have the responsibility for filing in the blanks on the cards for paragraphs (a)(2) (v), (vi), (vii), and (viii) of this section.

(3) The manufacturer shall maintain all cards received so that the manufacturer has a readily accessible record of the current purchaser or owner and the current address of all manufactured

homes manufactured by it for which a card has been received.

Subpart F—Dealer and Distributor Responsibilities

§ 3282.251 Scope and purpose.

(a) This subpart sets out the responsibilities which shall be met by distributors and dealers with respect to manufactured homes manufactured after the effective date of the standards for sale to purchasers in the United States. It prohibits the sale, lease, or offer for sale or lease of manufactured homes known by the distributor or dealer not to be in conformance with the standards, and it includes responsibilities for maintaining certain records and assisting in the gathering of certain information.

(b) The purpose of this subpart is to inform distributors and dealers when they may sell manufactured homes, when they are prohibited from selling manufactured homes, and what they may do in order to prepare a manufactured home for sale if it is not in conformance with the standards.

(c) For purposes of this part, any manufacturer or distributor who sells, leases, or offers for sale or lease a manufactured home to a purchaser shall be a dealer for purposes of that transaction.

§ 3282.252 Prohibition of sale.

(a) No distributor or dealer shall make use of any means of transportation affecting interstate or foreign commerce or the mails to sell, lease, or offer for sale or lease in the United States any manufactured home manufactured on or after the effective date of an applicable standard unless:

(1) There is affixed to the manufactured home a label certifying that the manufactured home conforms to applicable standards as required by §3282.205(c), and

(2) The distributor or dealer, acting as a reasonable distributor or dealer, does not know that the manufactured home does not conform to any applicable standards.

(b) This prohibition applies to any affected manufactured homes until the

completion of the entire sales transaction. A sales transaction with a purchaser is considered completed when all the goods and services that the dealer agreed to provide at the time the contract was entered into have been provided. Completion of a retail sale will be at the time the dealer completes set-up of the manufactured home if the dealer has agreed to provide the set-up, or at the time the dealer delivers the home to a transporter, if the dealer has not agreed to transport or set up the manufactured home, or to the site if the dealer has not agreed to provide set-up.

(c) This prohibition of sale does not apply to manufactured homes which are placed in production prior to the effective date of the standards, and it does not apply to "used" manufactured homes which are being sold or offered for sale after the first purchase in good faith for purposes other than the resale.

§ 3282.253 Removal of prohibition of sale.

(a) If a distributor or dealer has a manufactured home in its possession or a manufactured home with respect to which the sales transaction has not been completed, and the distributor or dealer, acting as a reasonable distributor or dealer, knows as a result of notification by the manufacturer or otherwise that the manufactured home contains a failure to conform or imminent safety hazard, the distributor or dealer may seek the remedies available to him under § 3282.415.

(b) When, in accordance with § 3282.415, a manufacturer corrects a failure to conform to the applicable standard or an imminent safety hazard, the distributor or dealer, acting as a reasonable distributor or dealer, may accept the remedies provided by the manufacturer as having corrected the failure to conform or imminent safety hazard. The distributor or dealer, therefore, may sell, lease, or offer for sale or lease any manufactured home so corrected by the manufacturer.

(c) When a distributor or dealer is authorized by a manufacturer to correct a failure to conform to the applicable standard or an imminent safety hazard and completes the correction in ac-

cordance with the manufacturer's instructions, the distributor or dealer may sell, or lease or offer for sale or lease the manufactured home in question, provided that the distributor or dealer, acting as a reasonable distributor or dealer knows that the manufactured home conforms to the standards. A distributor or dealer and a manufacturer, at the manufacturer's option, may agree in advance that the distributor or dealer is authorized to make such corrections as the manufacturer believes are within the expertise of the dealer.

(d) If the corrections made under paragraphs (b) and (c) of this section do not bring the manufactured home into conformance or correct the imminent safety hazard, the provisions of § 3282.415 will continue in effect prior to completion of the sales transaction.

§ 3282.254 Distributor and dealer alterations.

(a) If a distributor or dealer alters a manufactured home in such a way as to create an imminent safety hazard or to create a condition which causes a failure to conform with applicable Federal standards, the manufactured home affected may not be sold, leased, or offered for sale or lease.

(b) After correction by the distributor or dealer of the failure to conform or imminent safety hazard, the corrected manufactured home may be sold, leased, or offered for sale or lease.

(c) Distributors and dealers shall maintain complete records of all alterations made under paragraphs (a) and (b) of this section.

§ 3282.255 Completion of information card.

(a) Whenever a distributor or dealer sells a manufactured home subject to the standards to a purchaser, the distributor or dealer shall fill out the card with information provided by the purchaser and shall send the card to the manufacturer. (See § 3282.211.)

(b) Whenever a distributor or dealer sells a manufactured home to an owner which was originally manufactured under the standards, the distributor or dealer shall similarly use one of the detachable cards which was originally provided with the manufactured home.

§ 3282.256

If such a card is no longer available, the distributor or dealer shall obtain the information which the card would require and send it to the manufacturer of the manufactured home in an appropriate format.

§ 3282.256 Distributor or dealer complaint handling.

(a) When a distributor or dealer believes that a manufactured home in its possession which it has not yet sold to a purchaser contains an imminent safety hazard, serious defect, defect, or noncompliance, the distributor or dealer shall refer the matter to the manufacturer for remedial action under § 3282.415. If the distributor or dealer is not satisfied with the action taken by the manufacturer, it may refer the matter to the SAA in the state in which the manufactured home is located, or to the Secretary if there is no such SAA.

(b) Where a distributor or dealer receives a consumer complaint or other information concerning a manufactured home sold by the distributor or dealer, indicating the possible existence of an imminent safety hazard, serious defect, defect, or noncompliance in the manufactured home, the distributor or dealer shall refer the matter to the manufacturer.

Subpart G—State Administrative Agencies

§ 3282.301 General—scope.

This subpart sets out procedures to be followed and requirements to be met by States which wish to participate as State Administrative Agencies (SAA) under the Federal standards enforcement program. Requirements relating to States which wish to participate as primary inspection agencies under the Federal standards enforcement program are set out in subpart H of this part. Requirements which States must meet in order to receive full or conditional approval as SAAs and the responsibilities of such agencies are set out in § 3282.302. Reporting requirements for approved and conditionally approved SAAs are set out in subpart L.

24 CFR Ch. XX (4–1–11 Edition)

§ 3282.302 State plan.

A State wishing to qualify and act as a SAA under this subpart shall make a State Plan Application under this section. The State Plan Application shall be made to the Director, Manufactured Housing Standards Division, Department of Housing and Urban Development, 451 Seventh Street, SW., Washington, DC 20410, and shall include:

(a) An original and one copy of a cover sheet which shall show the following:

(1) The name and address of the State agency designated as the sole agency responsible for administering the plan throughout the State,

(2) The name of the administrator in charge of the agency,

(3) The name, title, address, and phone number of the person responsible for handling consumer complaints concerning standards related problems in manufactured homes under subpart I of this part,

(4) A list of personnel who will carry out the State plan,

(5) The number of manufactured home manufacturing plants presently operating in the State,

(6) The estimated total number of manufactured homes manufactured in the State per year,

(7) The estimated total number of manufactured homes set up in the State per year, and

(8) A certification signed by the administrator in charge of the designated State agency stating that, if it is approved by the Secretary, the State plan will be carried out in full, and that the regulations issued under the Act shall be followed,

(b) An original and one copy of appropriate materials which:

(1) Demonstrate how the designated State agency shall ensure effective handling of consumer complaints and other information referred to it that relate to noncompliances, defects, serious defects or imminent safety hazards as set out in subpart I of this part, including the holding of Formal and Informal Presentations of Views and the fulfilling of all other responsibilities of SAAs as set out in this subpart G,

(2) Provide that personnel of the designated agency shall, under State law or as agents of HUD, have the right at

any reasonable time to enter and inspect all factories, warehouses, or establishments in the State in which manufactured homes are manufactured,

(3) Provide for the imposition under State authority of civil and criminal penalties which are identical to those set out in section 611 of the Act, 42 U.S.C. 5410 except that civil penalties shall be payable to the State rather than to the United States,

(4) Provide for the notification and correction procedures under subpart I of this part where the State Administrative Agency is to act under that subpart by providing for and requiring approval by the State Administrative Agency of the plan for notification and correction described in § 3282.410, including approval of the number of units that may be affected and the proposed repairs, and by providing for approval of corrective actions where appropriate under subpart I,

(5) Provide for oversight by the SAA of:

(i) Remedial actions carried out by manufacturers for which the SAA approved the plan for notification or correction under § 3282.405, or § 3282.407, or for which the SAA has waived formal notification under § 3282.405 or § 3282.407, and

(ii) A manufacturer's handling of consumer complaints and other information under § 3282.404 as to plants located within the State,

(6) Provide for the setting of monitoring inspection fees in accordance with guidelines established by the Secretary and provide for participation in the fee distribution system set out in § 3282.307.

(7) Contain satisfactory assurances in whatever form is appropriate under State law that the designated agency has or will have the legal authority necessary to carry out the State plan as submitted for full or conditional approval,

(8) Contain satisfactory assurances that the designated agency has or will have, in its own staff or provided by other agencies of the state or otherwise, the personnel, qualified by education or experience necessary to carry out the State plan,

(9) Include the resumes of administrative personnel in policy making positions and of all inspectors and engineers to be utilized by the designated agency in carrying out the State plan,

(10) Include a certification that none of the personnel who may be involved in carrying out the State plan in any way are subject to any conflict of interest of the type discussed in § 3282.359 or otherwise, except that members of councils, committees, or similar bodies providing advice to the designated agency are not subject to the requirement,

(11) Include an estimate of the cost to the State of carrying out all activities called for in the State plan, under this section and § 3282.303, which estimate shall be broken down by particular function and indicate the correlation between the estimate and the number of manufactured homes manufactured in the State and the number of manufactured homes imported into the State, and the relationship of these factors to any fees currently charged and any fees charged during the preceding two calendar years. A description of all current and past State activities with respect to manufactured homes shall be included with this estimate.

(12) Give satisfactory assurances that the State shall devote adequate funds to carrying out its State plan,

(13) Indicate that State Law requires manufacturers, distributors, and dealers in the State to make reports pursuant to section 614 of the Act 42 U.S.C. 5413 and this chapter of these regulations in the same manner and to the same extent as if the State plan were not in effect,

(14) Provide that the designated agency shall make reports to the Secretary as required by subpart L of this part in such form and containing such information as the Secretary shall from time to time require,

(c) A state plan may be granted conditional approval if all of the requirements of § 3282.302 (a) and (b) are met except paragraphs (b)(2), (b)(3), (b)(6) or (b)(13). When conditional approval is given, the state shall not be considered approved under section 623 of the Act, 42 U.S.C. 5422, but it will participate in all phases of the program as called for

§ 3282.303

in its State plan. Conditional approval shall last for a maximum of five years, by which time all requirements shall be met for full approval, or conditional approval shall lapse. However, the Secretary may for good cause grant an extension of conditional approval upon petition by the SAA.

(d) If a State wishes to discontinue participation in the Federal enforcement program as an SAA, it shall provide the Secretary with a minimum of 90 days notice.

(e) *Exclusive IPIA status.* (1) A State that wishes to act as an exclusive IPIA under § 3282.352 shall so indicate in its State Plan and shall include in the information provided under paragraph (b)(11) of this section the fee schedule for the State's activities as an IPIA and the relationship between the proposed fees and the other information provided under paragraph (b)(11) of this section. If the Secretary determines that the fees to be charged by a State acting as an IPIA are unreasonable, the Secretary shall not grant the State status as an exclusive IPIA.

(2) The State shall also demonstrate in its State Plan that it has the present capability to act as an IPIA for all plants operating in the State.

[41 FR 19852, May 13, 1976, as amended at 47 FR 5888, Feb. 9, 1982; 51 FR 34468, Sept. 29, 1986; 61 FR 10860, Mar. 15, 1996]

§ 3282.303 State plan—suggested provisions.

The following are not required to be included in the State plan, but they are urged as necessary to provide full consumer protection and assurances of manufactured home safety:

(a) Provision for monitoring of dealers' lots within the State for transit damage, seal tampering, and dealer performance generally,

(b) Provision of approvals of all alterations made to certified manufactured homes by dealer in the State. Under this program, the State would assure that alterations did not result in the failure of the manufactured home to comply with the standards.

(c) Provision for monitoring of the installation of manufactured homes set up in the State to assure that the homes are properly installed and, where necessary, tied down,

24 CFR Ch. XX (4-1-11 Edition)

(d) Provision for inspection of used manufactured homes and requirements under State authority that used manufactured homes meet a minimal level of safety and durability at the time of sale, and,

(e) Provision for regulation of manufactured home transportation over the road to the extent that such regulation is not preempted by Federal authority.

§ 3282.304 Inadequate State plan.

If the Secretary determines that a State plan submitted under this subpart is not adequate, the designated State agency shall be informed of the additions and corrections required for approval. A revised State plan shall be submitted within 30 days of receipt of such determination. If the revised State plan is inadequate or if the State fails to resubmit within the 30 day period or otherwise indicates that it does not intend to change its State plan as submitted, the Secretary shall notify the designated State agency that the State plan is not approved and that it has a right to a hearing on the disapproval in accordance with subpart D of this part.

§ 3282.305 State plan approval.

The Secretary's approval or conditional approval of a State plan Application shall qualify that State to perform the functions for which it has been approved.

§ 3282.306 Withdrawal of State approval.

The Secretary shall, on the basis of reports submitted by the State, and on the basis of HUD monitoring, make a continuing evaluation of the manner in which each State is carrying out its State plan and shall submit the reports of such evaluation to the appropriate committees of the Congress. Whenever the Secretary finds, after affording due notice and opportunity for a hearing in accordance with subpart D of this part, that in the administration of the State program there is a failure to comply substantially with any provision of the State plan or that the State plan has become inadequate, the Secretary shall notify the State of withdrawal of approval or conditional approval of the State program. The State program

shall cease to be in effect at such time as the Secretary may establish.

§ 3282.307 Monitoring inspection fee establishment and distribution.

(a) Each approved State shall establish a monitoring inspection fee in an amount required by the Secretary. This fee shall be an amount paid by each manufactured home manufacturer in the State for each transportable section of each manufactured housing unit produced by the manufacturer in that State. In non-approved and conditionally-approved States, the fee shall be set by the Secretary.

(b) The monitoring inspection fee shall be paid by the manufacturer to the Secretary or to the Secretary's Agent, who shall distribute a portion of the fees collected from all manufactured home manufacturers among the approved and conditionally-approved States in accordance with an agreement between the Secretary and the States and based upon the following formula:

(1) \$9.00 of the monitoring inspection fee collected for each transportable section of each new manufactured housing unit that, after leaving the manufacturing plant, is first located on the premises of a dealer, distributor, or purchaser in that State; plus

(2) \$2.50 of the monitoring inspection fee collected for each transportable section of each new manufactured housing unit produced in a manufacturing plant in that State.

(c) A portion of the monitoring inspection fee collected also shall be distributed by the Secretary or the Secretary's Agent based on the extent of participation of the State in the Joint Team Monitoring Program set out in § 3282.308.

(d) To assure that a State devotes adequate funds to carry out its State Plan, a State may impose an additional reasonable inspection fee to offset expenses incurred by that State in conducting inspections. Such fee shall not exceed that amount which is the difference between the amount of funds distributed to the State as provided in paragraph (b) of this section and the amount necessary to cover the costs of inspections. Such fee shall be part of the State Plan pursuant to § 3282.302(b)

(11) and (12) and shall be subject to the approval of the Secretary pursuant to § 3282.305.

(e) The Secretary may establish by notice in the FEDERAL REGISTER a monitoring inspection fee which is to be paid by manufacturers for each transportable section of each manufactured housing unit manufactured in nonapproved and conditionally approved States as described in § 3282.210. To determine the amount of the inspection fee to be paid for each transportable section of each manufactured home, the Secretary shall divide the (estimated) number of transportable sections of manufactured homes (based on recent industry production figures) into the anticipated aggregate cost of conducting the inspection program in the foreseeable future. The time period selected for projecting the Department's inspection-related costs and number of transportable sections need not always be the same, but must be for a period of sufficient duration to provide for access to reasonable underlying data. To determine the aggregate cost of conducting the inspection program, the Secretary shall calculate the sum necessary to support:

(1) Inspection-related activities of State Administrative Agencies;

(2) Inspection-related activities performed by the Department of Housing and Urban Development;

(3) Inspection-related activities performed by monitoring inspection contractors;

(4) Miscellaneous activities involving the performance of inspection-related activities by the Department, including on-site inspections on an ad hoc basis; and

(5) Maintenance of adequate funds to offset short-term fluctuations in costs that do not warrant revising the fee under the authority of this section.

(f) The Secretary may at any time revise the amount of the fees established under paragraph (a) or (e) of this section by placing a notice of the amount of the revised fee in the FEDERAL REGISTER.

[50 FR 28398, July 12, 1985, as amended at 56 FR 65186, Dec. 16, 1991]

§ 3282.308

24 CFR Ch. XX (4-1-11 Edition)

§ 3282.308 State participation in monitoring of primary inspection agencies.

(a) An SAA may provide personnel to participate in joint team monitoring of primary inspection agencies as set out in subpart J. If an SAA wishes to do so, it must include in its State plan a list of what personnel would be supplied for the teams, their qualifications, and how many person-years the State would supply. All personnel will be subject to approval by the Secretary or the Secretary's agent. A person-year is 2,080 hours of work.

(b) If an SAA wishes to monitor the performance of primary inspection agencies acting within the State, it must include in its State plan a description of how extensively, how often, and by whom this will be carried out. This monitoring shall be coordinated by the Secretary, or the Secretary's agent with monitoring carried out by joint monitoring teams, and in no event shall an SAA provide monitoring where the State is also acting as a primary inspection agency.

§ 3282.309 Formal and informal presentations of views held by SAAs.

(a) When an SAA is the appropriate agency to hold a Formal or Informal Presentation of Views under § 3282.407 of subpart I, the SAA shall follow the procedures set out in §§ 3282.152 and 3282.153, with the SAA acting as the Secretary otherwise would under that section. Where § 3282.152 requires publication of notice in the FEDERAL REGISTER, the SAA shall, to the maximum extent possible, provide equivalent notice throughout the State by publication in the newspaper or newspapers having State-wide coverage or otherwise. The determination of whether to provide an Informal Presentation of Views under § 3282.152(f), or a Formal Presentation of Views under § 3282.152(g), is left to the SAA.

(b) Notwithstanding the provisions of § 3282.152(f)(2) and (g)(2) relating to the conclusive effect of a final determination, any party, in a proceeding held at an SAA under this section, including specifically the owners of affected manufactured homes, States in which affected manufactured homes are located, consumer groups representing

affected owners and manufacturers (but limited to parties with similar substantial interest) may appeal to the Secretary in writing any Final Determination by an SAA which is adverse to the interest of that party. This appeal on the record shall be made within 30 days of the date on which the Final Determination was made by the SAA.

[41 FR 19852, May 13, 1976, as amended at 51 FR 34468, Sept. 29, 1986]

Subpart H—Primary Inspection Agencies

§ 3282.351 General.

(a) This subpart sets out the requirements which must be met by States or private organizations which wish to qualify as primary inspection agencies under these regulations. It also sets out the various functions which will be carried out by primary inspection agencies.

(b) There are four basic functions which are performed by primary inspection agencies:

(1) Approval of the manufacturer's manufactured home design to assure that it is in compliance with the standard;

(2) Approval of the manufacturer's quality control program to assure that it is compatible with the design;

(3) Approval of the manufacturer's plant facility and manufacturing process to assure that the manufacturer can perform its approved quality control program and can produce manufactured homes in conformance with its approved design, and

(4) Performance of ongoing inspections of the manufacturing process in each manufacturing plant to assure that the manufacturer is continuing to perform its approved quality control program and, with respect to those aspects of manufactured homes inspected, is continuing to produce manufactured homes in performance with its approved designs and in conformance with the standards (see § 3282.362(c)(1)).

(c) There are two types of primary inspection agencies which perform these functions:

(1) Those which approve designs and quality control programs (Design Approval Primary Inspection Agencies—DAPIAs) and

(2) Those which approve plants and perform ongoing inspections in the manufacturing plants (Production Inspection Primary Inspection Agencies—IPIAs).

(d) States and private organizations whose submissions under this subpart are acceptable shall be granted provisional acceptance. Final acceptance shall be conditioned upon adequate performance, which will be determined through monitoring of the actions of the primary inspection agencies. Monitoring of all primary inspection agencies shall be carried out as set out in subpart J. HUD accepted agencies can perform DAPIA functions for any manufacturer in any State and IPIA functions in any State except those in which the State has been approved to act as the exclusive IPIA under § 3282.352.

(e) Primary inspection agencies approved under this subpart may contract with manufactured home manufacturers (see § 3282.202) to provide the services set out in this subpart. Any PIA which charges fees which are excessive in relation to the services rendered shall be subject to disqualification under § 3282.356.

§ 3282.352 State exclusive IPIA functions.

(a) Any State which has an approved State Administrative Agency may, if accepted as an IPIA, act as the exclusive IPIA within the State. A State which acts as an IPIA but is not approved as an SAA may not act as the exclusive IPIA in the State. A State which acts as an exclusive IPIA shall be staffed to provide IPIA services to all manufacturers within the state and may not charge unreasonable fees for those services.

(b) States which wish to act as exclusive IPIAs shall apply for approval to do so in their State plan applications. They shall specify the fees they will charge for IPIA services and shall submit proposed fee revisions to the Secretary prior to instituting any change in fees. If at any time the Secretary finds that those fees are not commensurate with the fees generally being

charged for similar services, the Secretary will withhold or revoke approval to act as an exclusive IPIA. States acting as DAPIAs and also as exclusive IPIAs shall establish separate fees for the two functions and shall specify what additional services (such as approval of design changes and full time inspections) these fees cover. As provided in § 3282.302(b)(11), each State shall submit fee schedules for its activities and, where appropriate, the fees presently charged for DAPIA and IPIA services, and any fees charged for DAPIA and IPIA services during the preceding two calendar years.

(c) A State's status as an exclusive IPIA shall commence upon approval of the State Plan Application and acceptance of the State's submission under § 3282.355. Where a private organization accepted or provisionally accepted as an IPIA under this subpart H is operating in a manufacturing plant within the State on the date the State's status as an exclusive IPIA commences, the private organization may provide IPIA services in that plant for 90 days after that date.

[61 FR 10861, Mar. 15, 1996]

§ 3282.353 Submission format.

States and private organizations which wish to act as primary inspection agencies shall submit to the Director, Manufactured Housing Standards Division, Department of Housing and Urban Development, 451 Seventh St. SW., Washington, DC 20410, an application which includes the following:

(a) A cover sheet which shall show the following:

(1) Name and address of the party making the application;

(2) The capacity (DAPIA, IPIA) in which the party wishes to be approved to act;

(3) A list of the key personnel who will perform the various functions required under these regulations;

(4) The number of manufactured home manufacturers and manufacturing plants for which the submitting party proposes to act in each of the capacities for which it wishes to be approved to act;

(5) The estimated total number of manufactured homes produced by those

§ 3282.354

manufacturers and in those plants per year;

(6) The number of years the proposed primary inspection agency has been actively engaged in the enforcement of manufactured home standards; and

(7) A certification by the party applying that it will follow the Federal manufactured home construction and safety standards set out at 24 CFR part 3280 and any interpretations of those standards which may be made by the Secretary.

(b) A detailed schedule of fees to be charged broken down by the services for which they will be charged.

(c) A detailed description of how the submitting party intends to carry out all of the functions for which it wishes to be approved under this subpart, with appropriate cross-references to sections of this subpart, including examples and complete descriptions of all reports, tests, and evaluations which the party would be required to make. Where appropriate, later sections of this subpart identify particular items which must be included in the submission. The Secretary may request further detailed information, when appropriate.

(d) A party wishing to be approved as a DAPIA shall submit a copy of a manufactured home design that it has approved (or if it has not approved a design, one that it has evaluated and a deviation report showing where the design is not in conformance with the standards) and a copy of a quality assurance manual that it has approved (or if it was not approved a manual, one that it has evaluated and a deviation report showing where the manual is inadequate).

(e) A party wishing to be approved as an IPIA shall submit a copy of a certification report which it has prepared for a manufactured home plant or, if it has not prepared such a report, an evaluation of a manufacturing plant which it has inspected with a description of what changes shall be made before a certification report can be issued. A party that has not previously inspected manufactured homes may nevertheless be accepted on the basis of the qualifications of its personnel and its com-

24 CFR Ch. XX (4-1-11 Edition)

mitment to perform the required functions.

[41 FR 19852, May 13, 1976, as amended at 61 FR 10861, Mar. 15, 1996]

§ 3282.354 Submittal of false information or refusal to submit information.

The submittal of false information or the refusal to submit information required under this subpart may be sufficient cause for the Secretary to revoke or withhold acceptance.

§ 3282.355 Submission acceptance.

(a) A party whose submission is determined by the Department to be adequate shall be granted provisional acceptance until December 15, 1976, or for a six month period from the date of such determination, whichever is later.

(b) Final acceptance of a party to act as a primary inspection agency will be contingent upon adequate performance during the period of provisional acceptance as determined through monitoring carried out under subpart J and upon satisfactory acceptance under § 3282.361(e) or § 3282.362(e). Final acceptance shall be withheld if performance is inadequate.

(c) Continued acceptance as a primary inspection agency shall be contingent upon continued adequacy of performance as determined through monitoring carried out under subpart J. If the Secretary determines that a primary inspection agency that has been granted final acceptance is performing inadequately, the Secretary shall suspend the acceptance, and the primary inspection agency shall be entitled to a Formal or Informal Presentation of Views as set out in subpart D of this part.

[41 FR 19852, May 13, 1976, as amended at 51 FR 34468, Sept. 29, 1986; 61 FR 10861, Mar. 15, 1996]

§ 3282.356 Disqualification and re-qualification of primary inspection agencies.

(a) The Secretary, based on monitoring reports or on other reliable information, may determine that a primary inspection agency which has been accepted under this subpart is not adequately carrying out one or more of its required functions. In so determining,

the Secretary shall consider the impact of disqualification on manufacturers and other affected parties and shall seek to assure that the manufacturing process is not disrupted unnecessarily. Whenever the Secretary disqualifies a primary inspection agency under this section, the primary inspection agency shall have a right to a Formal or Informal Presentation of Views under subpart D of this part.

(b) Interested persons may petition the Secretary to disqualify a primary inspection agency under the provisions of § 3282.156(b).

(c) A primary inspection agency which has been disqualified under paragraph (a) may resubmit an application under § 3282.353. The submission shall include a full explanation of how problems or inadequacies which resulted in disqualifications have been rectified and how the primary inspection agency shall assure that such problems shall not recur.

(d) When appropriate, the Secretary shall publish in the FEDERAL REGISTER or otherwise make available to the public for comment a disqualified PIA's application for requalification, subject to the provisions of § 3282.54.

(e) Both provisional and final acceptance of any IPIA (or DAPIA) automatically expires at the end of any period of one year during which it has not acted as an IPIA (or DAPIA). An IPIA (or DAPIA) has not acted as such unless it has actively performed its services as an IPIA (or DAPIA) for at least one manufacturer by which it has been selected. An IPIA (or DAPIA) whose acceptance has expired pursuant to this section may resubmit an application under § 3282.353 in order to again be qualified as an IPIA (or DAPIA), when it can show a bona fide prospect of performing IPIA (or DAPIA) services.

[41 FR 19852, May 13, 1976, as amended at 45 FR 59311, Sept. 9, 1980; 51 FR 34468, Sept. 29, 1986]

§ 3282.357 Background and experience.

All private organizations shall submit statements of the organizations' experience in the housing industry, including a list of housing products, equipment, and structures for which evaluation, testing and follow-up inspection services have been furnished.

They shall also submit statements regarding the length of time these services have been provided by them. In addition, all such submissions shall include a list of other products for which the submitting party provides evaluation, inspection, and listing or labeling services and the standard applied to each product, as well as the length of time it has provided these additional services.

§ 3282.358 Personnel.

(a) Each primary inspection agency shall have qualified personnel capable of carrying out all of the functions for which the primary inspection agency is seeking to be approved or disapproved. Where a State intends to act as the exclusive IPIA in the State, it shall show that it has adequate personnel to so act in all plants in the State.

(b) Each submission shall indicate the total number of personnel employed by the submitting party, the number of personnel available for this program, and the locations of the activities of the personnel to be used in the program.

(c) Each submission shall include the names and qualifications of the administrator and the supervisor who will be directly responsible for the program, and résumés of their experience.

(d) Each submission shall contain the information set out in paragraphs (d)(1) through (d)(9) of this section. Depending upon the functions (DAPIA or IPIA) to be undertaken by a particular primary inspection agency, some of the categories of personnel listed may not be required. In such cases, the submission should indicate which of the categories of information are not required and explain why they are not needed. The submission should identify which personnel will carry out each of the functions the party plans to perform. The qualifications of the personnel to perform one or more of the functions will be judged in accordance with the requirements of ASTM Standard E-541 except that the requirement for registration as a professional engineer or architect may be waived for personnel whose qualifications by experience or education equal those of a registered engineer or architect. The categories of

§ 3282.359

24 CFR Ch. XX (4-1-11 Edition)

personnel to be included in the submission are as follows:

(1) The names of engineers practicing structural engineering who will be involved in the evaluation, testing, or followup inspection services, and résumés of their experience.

(2) The names of engineers practicing mechanical engineering who will be involved in the evaluation, testing, or followup, inspection services and résumés of their experience.

(3) The names of engineers practicing electrical engineering who will be involved in the evaluation, testing, or followup inspection services and résumés of their experience.

(4) The names of engineers practicing fire protection engineering who will be involved in the evaluation, testing, or followup inspection services, and résumés of their experience.

(5) The names of all other engineers assigned to this program, the capacity in which they will be employed, and résumés of their experience.

(6) The names of all full-time and part-time consulting architects and engineers, their registration, and résumés of their experience.

(7) The names of inspectors and other technicians along with résumés of experience and a description of the type of work each will perform.

(8) A general outline of the applicant agency's training program for assuring that all inspectors and other technicians are properly trained to do each specific job assigned.

(9) The names and qualifications of individuals serving on advisory panels that assist the applicant agency in making its policies conform with the public interest in the field of public health and safety.

(e) All information required by this section shall be kept current. The Secretary shall be notified of any change in personnel or management or change of ownership or State jurisdiction within 30 days of such change.

§ 3282.359 Conflict of interest.

(a) All submissions by private organizations shall include a statement that the submitting party is independent in that it does not have any actual or potential conflict of interest and is not affiliated with or influenced or con-

trolled by any producer, supplier, or vendor of products in any manner which might affect its capacity to render reports of findings objectively and without bias.

(b) A private organization shall be judged to be free of conflicting affiliation, influence, and control if it demonstrates compliance with all of the following criteria:

(1) It has no managerial affiliation with any producer, supplier, or vendor of products for which it performs PIA services, and is not engaged in the sale or promotion of any such product or material;

(2) The results of its work do not accrue financial benefits to the organization via stock ownership of any producer, supplier or vendor of the products involved;

(3) Its directors and other management personnel and its engineers and inspectors involved in certification activities hold no stock in and receive no stock option or other benefits, financial, or otherwise, from any producer, supplier, or vendor of the product involved, other than compensation under § 3282.202 of this part;

(4) The employment security status of its personnel is free of influence or control of any producer, supplier, or vendor, and

(5) It does not perform design or quality assurance manual approval services for any manufacturer whose design or manual has been created or prepared in whole or in part by engineers of its organization or engineers of any affiliated organization.

(c) All submissions by States shall include a statement that personnel who will be in any way involved in carrying out the State plan or PIA function are free of any conflict of interest except that with respect to members of councils, committees or similar bodies providing advice to the designated agency are not subject to this requirement.

§ 3282.360 PIA acceptance of product certification programs or listings.

In determining whether products to be included in a manufactured home are acceptable under the standards set out in part 3280 of 24 CFR, all PIAs shall accept all product verification

programs, labelings, and listings unless the PIA has reason to believe that a particular certification is not acceptable, in which case, the PIA shall so inform the Secretary and provide the Secretary with full documentation and information on which it bases its belief. Pending a determination by the Secretary, the PIA shall provisionally accept the certification. The Secretary's determination shall be binding on all PIAs.

§ 3282.361 Design Approval Primary Inspection Agency (DAPIA).

(a) *General.* (1) The DAPIA selected by a manufacturer under § 3282.203 shall be responsible for evaluating all manufactured home designs submitted to it by the manufacturer and for assuring that they conform to the standards. It shall also be responsible for evaluating all quality control programs submitted to it by the manufacturer by reviewing the quality assurance manuals in which the programs are set out to assure that the manuals reflect programs which are compatible with the designs to be followed and which commit the manufacturer to make adequate inspections and tests of every part of every manufactured home produced.

(2) A design or quality assurance manual approved by a DAPIA shall be accepted by all IPIAs acting under § 3282.362 who deal with the design, quality assurance manual, or manufactured homes built to them, and by all other parties, as, respectively, being in conformance with the Federal standards or as providing for adequate quality control to assure conformance. However, each design and quality assurance manual is subject to review and verification by the Secretary or the Secretary's agent at any time.

(b) *Designs.* (1) In evaluating designs for compliance with the standards, the DAPIA will not allow any deviations from accepted engineering practice standards for design calculations or any deviations from accepted test standards, except that the DAPIA, for good cause, may request the Secretary to accept innovations which are not yet accepted practices. Acceptances by the Secretary shall be published in the form of interpretative bulletins, where appropriate.

(2) The DAPIA shall require the manufacturer to submit floor plans and specific information for each manufactured home design or variation which the DAPIA is to evaluate. It shall also require the submission of drawings, specifications, calculations, and test records of the structural, electrical and mechanical systems of each such manufactured home design or variation. The manufacturer need not supply duplicate information where systems are common to several floor plans. Each DAPIA shall develop and carry out procedures for evaluating original manufactured home designs by requiring manufacturers to submit necessary drawings and calculations and carry out such verifications and calculations as it deems necessary. Where compliance with the standards cannot be determined on the basis of drawings and calculations, the DAPIA shall require any necessary tests to be carried out at its own facility, at separate testing facilities or at the manufacturer's plant.

(3) *Design deviation report.* After evaluating the manufacturer's design, the DAPIA shall furnish the manufacturer with a design deviation report which specifies in detail, item by item with appropriate citations to the standards, the specific deviations in the manufacturer's design which must be rectified in order to produce manufactured homes which comply with the standards. The design deviation report may acknowledge the possibility of alternative designs, tests, listings, and certifications and state the conditions under which they will be acceptable. The design deviation report shall, to the extent practicable, be complete for each design evaluated in order to avoid repeated rejections and additional costs to the manufacturer.

(4) *Design approval.* The DAPIA shall signify approval of a design by placing its stamp of approval or authorized signature on each drawing and each sheet of test results. The DAPIA shall clearly cross-reference the calculations and test results to applicable drawings. The DAPIA may require the manufacturer to do the cross-referencing if it wishes. It shall indicate on each sheet how any deviations from the standards have been or shall be resolved. Within 5 days after approving a design, the DAPIA

shall forward a copy of the design to the manufacturer and the Secretary or the Secretary's agent (prior to the effective date of the standards the latter copy shall go to the Secretary.)

The DAPIA shall maintain a complete up-to-date set of approved designs and design changes approved under paragraph (b)(5) of this section which it can duplicate and copies of which it can furnish to interested parties as needed when disputes arise.

(5) *Design change approval.* The DAPIA shall also be responsible for approving all changes which a manufacturer wishes to make in a design approved by the DAPIA. In reviewing design changes, the DAPIA shall respond as quickly as possible to avoid disruption of the manufacturing process. Within 5 days after approving a design change, the DAPIA shall forward a copy of this change to the manufacturer and the Secretary or the Secretary's agent as set out in paragraph (b)(4) of this section to be included in the design to which the change was made.

(c) *Quality assurance manuals.* (1) In evaluating a quality assurance manual, the DAPIA shall identify any aspects of designs to be manufactured under the manual which require special quality control procedures. The DAPIA shall determine whether the manual under which a particular design is to be manufactured reflects those special procedures, and shall also determine whether the manuals which it evaluates provide for such inspections and testing of each manufactured home so that the manufacturer, by following the manual, can assure that each manufactured home it manufactures will conform to the standards. The manual shall, at a minimum, include the information set out in § 3282.203(c).

(2) *Manual deviation report.* After evaluating a manufacturer's quality assurance manual, the DAPIA shall furnish the manufacturer with a manual deviation report which specifies in detail any changes which a manufacturer must make in order for the quality assurance manual to be acceptable. The manual deviation report shall, to the extent practicable, be complete for each design in order to avoid repeated

rejections and additional costs to the manufacturer.

(3) *Manual approval.* The DAPIA shall signify approval of the manufacturer's quality assurance manual by placing its stamp of approval or authorized signature on the cover page of the manual. Within 5 days of approving a quality assurance manual, the DAPIA shall forward a copy of the quality assurance manual to the manufacturer and the Secretary or the Secretary's agent (prior to the effective date of the standards, the latter copy shall go to the Secretary). The DAPIA shall maintain a complete up-to-date set of approved manuals and manual changes approved under paragraph (c)(4) of this section which it can duplicate and copies of which it can furnish to interested parties as needed when disputes arise.

(4) *Manual change approval.* Each change the manufacturer wishes to make in its quality assurance manual shall be approved by the DAPIA. Within 5 days after approving a manual change, the DAPIA shall forward a copy of the change to the manufacturer and the Secretary or the Secretary's agent as set out in paragraph (c)(3) of this section to be included in the manual to which the change was made.

(d) *Requirements for full acceptance—DAPIA.* (1) Before granting full acceptance to a DAPIA, the Secretary or the Secretary's agent shall review and evaluate at least one complete design and one quality assurance manual which has been approved by the DAPIA. These shall be designs and manuals approved to the Federal standards, and they shall be chosen at random from those approved by the DAPIA during the period of provisional acceptance.

(2) If the Secretary determines that a design or quality assurance manual shows an inadequate level of performance, the Secretary or the Secretary's agent shall carry out further evaluations. If the Secretary finds the level of performance to be unacceptable, the Secretary shall not grant full acceptance. If full acceptance has not been granted by the end of the provisional acceptance period, provisional acceptance shall lapse unless the Secretary determines that the failure to obtain full acceptance resulted from the fact

that the Secretary or her agent has not had adequate time in which to complete an evaluation.

[41 FR 19852, May 13, 1976, as amended at 61 FR 10861, Mar. 15, 1996]

§ 3282.362 Production Inspection Primary Inspection Agencies (IPIAs).

(a) *General*—(1) *IPIA responsibilities.* An IPIA selected by a manufacturer under § 3282.204 to act in a particular manufacturing plant shall be responsible for assuring:

(i) That the plant is capable of following the quality control procedures set out in the quality assurance manual to be followed in that plant;

(ii) That the plant continues to follow the quality assurance manual;

(iii) That any part of any manufactured home that it actually inspects conforms with the design, or where the design is not specific with respect to an aspect of the standards, to the standards;

(iv) That whenever it finds a manufactured home in production which fails to conform to the design or where the design is not specific, to the standards, the failure to conform is corrected before the manufactured home leaves the manufacturing plant; and

(v) That if a failure to conform to the design, or where the design is not specific, to the standards, is found in one manufactured home, all other homes still in the plant which the IPIA's records or the records of the manufacturer indicate might not conform to the design or to standards are inspected and, if necessary, brought up to the standards before they leave the plant.

(2) No more than one IPIA shall operate in any one manufacturing plant, except that where a manufacturer decides to change from one IPIA to another, the two may operate in the plant simultaneously for a limited period of time to the extent necessary to assure a smooth transition.

(b) *Plant approval.* (1) Each IPIA shall, with respect to each manufacturing plant for which it is responsible, evaluate the quality control procedures being followed by the manufacturer in the plant to determine whether those procedures are consistent with and fulfill the procedures set out in the

DAPIA approved quality assurance manual being followed in the plant. As part of this evaluation, and prior to the issuance of any labels to the manufacturer, the IPIA shall make a complete inspection of the manufacture of at least one manufactured home through all of the operations in the manufacturer's plant. The purpose of this initial factory inspection is to determine whether the manufacturer is capable of producing manufactured homes in conformance with the approved design and, to the extent the design is not specific with respect to an aspect of the standards, with the standards and to determine whether the manufacturer's quality control procedures as set out in the quality assurance manual, plant equipment, and personnel, will assure that such conformance continues. This inspection should be made by one or more qualified engineers who have reviewed the approved design and by an inspector who has been carefully briefed by the engineers on the restrictive aspects of the design. The manufactured home shall be inspected to the approved design for the home except that where the design is not specific with respect to any aspect of the standards, the inspection shall be to the standards as to that aspect of the manufactured home. If the first manufactured home inspected fails to conform to the design or, with respect to any aspect of the standards not specifically covered by the design, to the standards, additional units shall be similarly inspected until the IPIA is satisfied that the manufacturer is conforming to the approved design, or where the design is not specific with respect to any aspect of the standards, to the standards and quality assurance manual.

(2) *Certification report.* If, on the basis of the initial comprehensive factory inspection required by paragraph (b)(1) of this section, the IPIA determines that the manufacturer is performing adequately, the IPIA shall prepare and forward to the manufacturer, to HUD, and to HUD's agent a certification report as described in this paragraph (b)(2) of this section. The issuance of the certification report is a prerequisite to the commencement of production surveillance under paragraph (c) of this

section in the plant for which the report is issued. At the time the certification report is issued, the IPIA may provide the manufacturer with a two to four week supply of labels to be applied to manufactured homes produced in the plant. The IPIA shall maintain a copy of each certification report which it issues.

(3) The certification report shall include:

(i) The name of the DAPIA which approved the manufacturer's design and quality assurance manual and the dates of those approvals,

(ii) The names and titles of the IPIA engineers and inspectors who performed the initial comprehensive inspection,

(iii) A full report of inspections made, serial numbers inspected, any failures to comply which were observed, corrective actions taken, and dates of inspections, and

(iv) A certification that at least one manufactured home has been completely inspected in all phases of its production in the plant, that the manufacturer is performing in conformance with the approved designs and quality assurance manual and, to the extent the design is not specific with respect to any aspects of the standards, with the standards, and the IPIA is satisfied that the manufacturer can produce manufactured homes in conformance with the designs, and where the designs are not specific, with the standards on a continuing basis.

(4) *Inadequate manufacturer performance.* Where an IPIA determines that the performance of a manufacturer is not yet adequate to justify the issuance of a certification report and labels to the manufacturer, the IPIA may label manufactured homes itself by using such of its personnel as it deems necessary to perform complete inspections of all phases of production of each manufactured home being produced and labeling only those determined after any necessary corrections to be in conformance with the design and, as appropriate, with the standards. This procedure shall continue until the IPIA determines that the manufacturer's performance is adequate to justify the issuance of a certification report.

(c) *Production surveillance.* (1) After it has issued a certification report under paragraph (b) of this section, the IPIA shall carry out ongoing surveillance of the manufacturing process in the plant. The IPIA shall be responsible for conducting representative inspections to assure that the manufacturer is performing its quality control program pursuant to and consistent with its approved quality assurance manual and to assure that whatever part of a manufactured home is actually inspected by the IPIA is fully in conformance with the design and, as appropriate under paragraph (a)(1)(iii) of this section, with the standards before a label is issued for or placed on that manufactured home. The surveillance visits shall commence no later than that date on which the IPIA determines they must commence so that the IPIA can assure that every manufactured home to be produced after the effective date of the standards to which a label provided for in paragraph (c)(2) of this section is affixed, is inspected in at least one stage of its production. The frequency of subsequent visits to the plant shall continue to be such that every manufactured home is inspected at some stage in its production. In the course of each visit, the IPIA shall make a complete inspection of every phase of production and of every visible part of every manufactured home which is at each stage of production. The inspection shall be made to the approved design except where the design is not specific with respect to an aspect of the standards, in which case the inspection of that aspect of the manufactured home shall be made to the standards. The IPIA shall assure that no label is placed on any manufactured home which it finds fails to conform with the approved design or, as appropriate, the standards in the course of these inspections and shall assure that no labels are placed on other manufactured homes still in the plant which may also not conform until those homes are inspected and if necessary corrected to the design or the standards. If an IPIA finds a manufactured home that fails to conform to the design, or as appropriate under paragraph (a)(1)(iii) of this section, to the standards, the IPIA may, in addition to

withholding the label for the unit, proceed to red tag the home until the failure to conform is corrected. Only the IPIA is authorized to remove a red tag. When manufactured homes repeatedly fail to conform to the design, or as appropriate under paragraph (a)(1)(iii) of this section, to the standards in the same assembly station or when there is evidence that the manufacturer is ignoring or not performing under its approved quality assurance manual, the IPIA shall increase the frequency of these inspections until it is satisfied that the manufacturer is performing to its approved quality assurance manual. Failure to perform to the approved manual justifies withholding labels until an adequate level of performance is attained. As part of its function of assuring quality control, the IPIA shall inspect materials in storage and test equipment used by the manufacturer at least once a month, and more frequently if unacceptable conditions are observed. With the prior approval of the Secretary, an IPIA may decrease the frequency of any inspections.

(2) *Labeling*—(i) *Labels required.* (A) The IPIA shall continuously provide the manufacturer with a two- to four-week supply (at the convenience of the IPIA and the manufacturer) of the labels described in this subsection, except that no labels shall be issued for use when the IPIA is not present if the IPIA is not satisfied that the manufacturer can and is producing manufactured homes which conform to the design and, as appropriate, to the standards. Where necessary, the IPIA shall reclaim labels already given to the manufacturer. In no event shall the IPIA allow a label to be affixed to a manufactured home if the IPIA believes that the manufactured home fails to conform to the design, or, where the design is not specific with respect to an aspect of the standards, to the standards. Labels for such manufactured homes shall be provided only after the failure to conform has been remedied, or after the Secretary has determined that there is no failure to conform.

(B) A permanent label shall be affixed to each transportable section of each manufactured home for sale or lease to a purchaser or lessor in the

United States in such a manner that removal will damage the label so that it cannot be reused. This label is provided by the IPIA and is separate and distinct from the data plate that the manufacturer is required to provide under § 3280.5.

(C) The label shall read as follows:

“As evidenced by this label No. ABC 000 001, the manufacturer certifies to the best of the manufacturer’s knowledge and belief that this manufactured home has been inspected in accordance with the requirements of the Department of Housing and Urban Development and is constructed in conformance with the Federal Manufactured Home Construction and Safety Standards in effect on the date of manufacture. See data plate.”

(D) The label shall be 2 in. by 4 in. in size and shall be permanently attached to the manufactured home by means of 4 blind rivets, drive screws, or other means that render it difficult to remove without defacing it. It shall be etched on .032 in. thick aluminum plate. The label number shall be etched or stamped with a 3 letter IPIA designation which the Secretary shall assign and a 6 digit number which the label supplier shall stamp sequentially on labels supplied to each IPIA.

(E) The label shall be located at the tail-light end of each transportable section of the manufactured home approximately one foot up from the floor and one foot in from the road side, or as near that location on a permanent part of the exterior of the manufactured home as practicable. The roadside is the right side of the manufactured home when one views the manufactured home from the tow bar end of the manufactured home. It shall be applied to the manufactured home unit in the manufacturing plant by the manufacturer or the IPIA, as appropriate.

(F) The label shall be provided to the manufacturer only by the IPIA. The IPIA shall provide the labels in sequentially numbered series. The IPIA may obtain labels from the Secretary or the Secretary’s agent, or where the IPIA obtains the prior approval of the Secretary, from a label manufacturer. However, if the IPIA obtains labels directly from a label supplier, those labels must be sequentially numbered without any duplication of label numbers.

(G) Whenever the IPIA determines that a manufactured home which has been labeled, but which has not yet been released by the manufacturer may not conform to the design or, as appropriate under paragraph (a)(1)(iii) of this section, to the standards, the IPIA by itself or through an agent shall red tag the manufactured home. Where the IPIA determines that a manufactured home which has been labeled and released by the manufacturer, but not yet sold to a purchaser (as described in § 3282.252(b)), the IPIA may, in its discretion, proceed to red tag the manufactured home. Only the IPIA is authorized to remove red tags, though it may do so through agents which it deems qualified to determine that the failure to conform has been corrected. Red tags may be removed when the IPIA is satisfied, through inspections, assurances from the manufacturer, or otherwise, that the affected homes conform.

(H) Labels that are damaged, destroyed, or otherwise made illegible or removed shall be replaced by the IPIA, after determination that the manufactured home is in compliance with the standards, by a new label of a different serial number. The IPIA's labeling record shall be permanently marked with the number of the replacement label and a corresponding record of the replacement label.

(ii) *Label control.* The labels used in each plant shall be under the direct control of the IPIA acting in that plant. Only the IPIA shall provide the labels to the manufacturer. The IPIA shall assure that the manufacturer does not use any other label to indicate conformance to the standards.

(A) The IPIA shall be responsible for obtaining labels. Labels shall be obtained from HUD or its agent, or with the approval of the Secretary, from a label manufacturer. The labels shall meet the requirements of this section. Where the IPIA obtains labels directly from a label manufacturer, the IPIA shall be responsible for assuring that the label manufacturer does not provide labels directly to the manufacturer of manufactured homes. If the label manufacturer fails to supply correct labels or allows labels to be released to parties other than the IPIA,

the IPIA shall cease dealing with the label manufacturer.

(B) The labels shall be shipped to and stored by the IPIA's at a location which permits ready access to manufacturing plants under its surveillance. The labels shall be stored under strict security and inventory control. They shall be released only by the IPIA to the manufacturer under these regulations.

(C) The IPIA shall be able to account for all labels which it has obtained through the date on which the manufactured home leaves the manufacturing plant, and it shall be able to identify the serial number of the manufactured home to which each particular label is affixed.

(D) The IPIA shall keep in its central record office a list of the serial numbers of labels issued from the label producer to the IPIA and by the IPIA to the manufacturing plant.

(E) Failure to maintain control of labels through the date the manufactured home leaves the manufacturing plant and failure to keep adequate records of which label is on which manufactured home shall render the IPIA subject to disqualification under § 3282.356.

(3) *Data plate.* (i) The IPIA shall assure that each manufactured home produced in each manufacturing plant under its surveillance is supplied with a data plate which meets the requirements of this section and of § 3280.5 of chapter XX of 24 CFR. The data plate shall be furnished by the manufacturer and affixed inside the manufactured home on or near the main electrical distribution panel. The data plate shall contain the following information:

(A) The name and address of the manufacturing plant in which the manufactured home was manufactured,

(B) The serial number and model designation of the unit and the date the unit was manufactured,

(C) The statement "This manufactured home is designed to comply with the Federal Manufactured Home Construction and Safety Standards in force at the time of manufacture.",

(D) A list of major factory-installed equipment including the manufacturer's name and the model designation of each appliance,

(E) Reference to the roof load zone and wind load zone for which the home is designed and duplicates of the maps as set forth in § 3280.305. This information may be combined with the heating/cooling certificate and insulation zone map required by §§ 3280.510 and 3280.511. The Wind Zone Map on the Data Plate shall also contain the statement:

This home has not been designed for the higher wind pressures and anchoring provisions required for ocean/coastal areas and should not be located within 1500' of the coastline in Wind Zones II and III, unless the home and its anchoring and foundation system have been designed for the increased requirements specified for Exposure D in ANSI/ASCE 7-88.

(F) The statement:

This home has ____ has not ____ (appropriate blank to be checked by manufacturer) been equipped with storm shutters or other protective coverings for windows and exterior door openings. For homes designed to be located in Wind Zones II and III, which have not been provided with shutters or equivalent covering devices, it is strongly recommended that the home be made ready to be equipped with these devices in accordance with the method recommended in the manufacturers printed instructions.

(G) The statement: "Design Approval by", followed by the name of the agency that approved the design.

(ii) A copy of the data plate shall be furnished to the IPIA, and the IPIA shall keep a permanent record of the data plate as part of its labeling record so that the information is available during the life of the manufactured home in case the data plate in the manufactured home is defaced or destroyed.

(d) *Permanent records.* The IPIA shall maintain the following records as appropriate:

(1) Records of all labels issued, applied, removed, and replaced by label number, manufactured home serial number, manufactured home type, manufacturer's name, dealer destination, and copies of corresponding data plates.

(2) Records of all manufactured homes which are red tagged, and the status of each home.

(3) Records of all inspections made at each manufacturing plant on each manufactured home serial number,

each failure to conform found, and the action taken in each case.

(4) Records of all inspections made at other locations of manufactured homes identified by manufacturer and serial number, all manufactured homes believed to contain the same failure to conform, and the action taken in each case.

All records shall specify the precise section of the standard which is in question and contain a clear and concise explanation of the process by which the IPIA reached any conclusions. All records shall be traceable to specific manufactured home serial numbers and through the manufacturer's records to dealers and purchasers.

(e) *Requirements for full acceptance— IPIA.* (1) Before granting full acceptance to an IPIA, the Secretary or the Secretary's agent shall review and evaluate at least one certification report which has been prepared by the IPIA during the period of provisional acceptance. The Secretary or the Secretary's agent shall also review in depth the IPIA's administrative capabilities and otherwise review the IPIA's performance of its responsibilities under these regulations.

(2) Where the Secretary determines on the basis of these reviews that an IPIA is not meeting an adequate level of performance, the Secretary or the Secretary's agent shall carry out further evaluations. If the Secretary finds the level of performance to be unacceptable, the Secretary shall not grant full acceptance. If full acceptance has not been granted by the end of the provisional acceptance period, provisional acceptance shall lapse unless the Secretary determines that the failure to obtain full acceptance resulted from the fact that the Secretary or the Secretary's agent has not had adequate time in which to complete an evaluation.

[41 FR 19852, May 13, 1976, as amended at 42 FR 2580, Jan. 12, 1977; 42 FR 35157, July 8, 1977; 59 FR 2474, Jan. 14, 1994; 61 FR 10861, Mar. 15, 1996]

§ 3282.363 Right of entry and inspection.

Each primary inspection agency shall secure from each manufacturer and

§ 3282.364

24 CFR Ch. XX (4-1-11 Edition)

manufacturing plant under its surveillance an agreement that the Secretary, the State Administrative Agency and the primary inspection agency have the right to inspect the plant and its manufactured home inspection, labeling, and delivery records, and any of its manufactured homes in the hands of dealers or distributors at any reasonable time.

§ 3282.364 Inspection responsibilities and coordination.

All primary inspection agencies shall be responsible for acting as necessary under their contractual commitment with the manufacturer to determine whether alleged failures to conform to the standards may exist in manufactured homes produced under their surveillance and to determine the source of the problems. The DAPIA may be required to examine the designs in question or the quality assurance manual under which the manufactured homes were produced. The IPIA may be required to reexamine the quality control procedures which it has approved to determine if they conform to the quality assurance manual, and the IPIA shall have primary responsibility for inspecting actual units produced and, where necessary, for inspecting units released by the manufacturer. All primary inspection agencies acting with respect to particular manufacturer or plant shall act in close coordination so that all necessary functions are performed effectively and efficiently.

§ 3282.365 Forwarding monitoring fee.

The IPIA shall, whenever it provides labels to a manufacturer, obtain from the manufacturer the monitoring fee to be forwarded to the Secretary or the Secretary's agent as set out in § 3282.210. If a manufacturer fails to provide the monitoring fee as required by § 3282.210 to be forwarded by the IPIA under this section, the IPIA shall immediately inform the Secretary; or the Secretary's Agent.

§ 3282.366 Notification and correction campaign responsibilities.

(a) Both IPIAs and DAPIAs are responsible for assisting the Secretary or an SAA in identifying the class of man-

ufactured homes that may have been affected where the Secretary or an SAA makes or is contemplating making a preliminary determination of imminent safety hazard, serious defect, defect, or noncompliance under § 3282.407 with respect to manufactured homes for which the IPIA or DAPIA provided either plant inspection or design approval services.

(b) The IPIA in each manufacturing plant is responsible for reviewing manufacturer determinations of the class of manufactured homes affected when the manufacturer is acting under § 3282.404. The IPIA shall concur in the method used to determine the class of potentially affected manufactured homes or shall state why it finds the method to be inappropriate, inadequate or incorrect.

[42 FR 2580, Jan. 12, 1977]

Subpart I—Consumer Complaint Handling and Remedial Actions

SOURCE: 42 FR 2580, Jan. 12, 1977, unless otherwise noted.

§ 3282.401 Purpose and scope.

(a) The purpose of this subpart is to establish a system under which the protections of the Act are provided with a minimum of formality and delay, but in which the rights of all parties are protected.

(b) This subpart sets out the procedures to be followed by manufacturers, State Administrative Agencies, primary inspection agencies, and the Secretary to assure that manufacturers provide notification and correction with respect to their manufactured homes as required by the Act. Notification and correction may be required to be provided with respect to manufactured homes that have been sold or otherwise released by the manufacturer to another party when the manufacturer, an SAA or the Secretary determines that an imminent safety hazard, serious defect, defect, or non-compliance may exist in those manufactured homes as set out herein.

(c) This subpart sets out the rights of dealers under section 613 of the Act, 42 U.S.C. 5412, to obtain remedies from

manufacturers in certain circumstances.

§ 3282.402 General principles.

(a) Nothing in this subpart or in these regulations shall limit the rights of the purchaser under any contract or applicable law.

(b) The liability of manufactured home manufacturers to provide remedial actions under this subpart is limited by the principle that manufacturers are not responsible for failures that occur in manufactured homes or components solely as the result of normal year and aging, gross and unforeseeable consumer abuse, or unforeseeable neglect of maintenance.

(c) The extent of a manufacturer's responsibility for providing notification or correction depends upon the seriousness of problems for which the manufacturer is responsible under this subpart.

(d) When manufacturers act under § 3282.404 of these regulations, they will not be required to classify the problem that triggered their action as a non-compliance, defect, serious defect, or imminent safety hazard.

(e) It is the policy of these regulations that all consumer complaints or other information indicating the possible existence of an imminent safety hazard, serious defect, defect, or non-compliance should be referred to the manufacturer of the potentially affected manufactured homes as early as possible so that the manufacturer can begin to timely respond to the consumer and take any necessary remedial actions.

§ 3282.403 Consumer complaint and information referral.

When a consumer complaint or other information indicating the possible existence of a noncompliance, defect, serious defect, or imminent safety hazard is received by a State Administrative Agency or the Secretary, the SAA or the Secretary shall forward the complaint or other information to the manufacturer of the manufactured home in question. The SAA or the Secretary shall, when it appears from the complaint or other information that more than one manufactured home may be involved, simultaneously send

a copy of the complaint or other information to the SAA of the State where the manufactured home was manufactured or to the Secretary if there is no such SAA, and when it appears that an imminent safety hazard or serious defect may be involved, simultaneously send a copy to the Secretary.

§ 3282.404 Notification pursuant to manufacturer's determination.

(a) The manufacturer shall provide notification as set out in this subpart with respect to all manufactured homes produced by the manufacturer in which there exists or may exist an imminent safety hazard or serious defect. The manufacturer shall provide such notification with respect to manufactured homes produced by the manufacturer in which a defect exists or may exist if the manufacturer has information indicating that the defect may exist in a class of manufactured homes that is identifiable because the cause of the defect or defects actually known to the manufacturer is such that the same defect would probably have been systematically introduced into more than one manufactured home during the course of production. This information may include, but is not limited to, complaints that can be traced to the same cause, defects known to exist in supplies of components or parts, information related to the performance of a particular employee and information indicating a failure to follow quality control procedures with respect to a particular aspect of the manufactured home. A manufacturer is required to provide notification with respect to a noncompliance only after the issuance of a final determination under § 3282.407.

(b) Whenever the manufacturer receives from any source information that may indicate the existence of a problem in a manufactured home for which the manufacturer is responsible for providing notification under paragraph (a) of this section, the manufacturer shall, as soon as possible, but not later than 20 days after receipt of the information, carry out any necessary investigations and inspections to determine and shall determine whether the manufacturer is responsible for providing notification under paragraph (a)

of this section. The manufacturer shall maintain complete records of all such information and determinations in a form that will allow the Secretary or an SAA readily to discern who made the determination with respect to a particular piece of information, what the determination was, and the basis for the determination. Such records shall be kept for a minimum of five years from the date the manufacturer received the information. Consumer complaints or other information indicating the possible existence of non-compliances or defects received prior to the effective date of this section shall, for purposes of this subpart, be deemed to have been received on the date this section became effective.

(c) If a manufacturer determines under paragraph (b) of this section that the manufacturer is responsible for providing notification under paragraph (a) of this section, the manufacturer shall prepare a plan for notification as set out in § 3282.409. Where the manufacturer is required to correct under § 3282.406, the manufacturer shall include in the plan provision for correction of affected manufactured homes. The manufacturer shall, as soon as possible, but not later than 20 days after making the determination, submit the plan to one of the following, as appropriate:

(1) Where the manufactured homes covered by the plan were all manufactured in one State, to the SAA of the State of manufacture;

(2) Where the manufactured homes were manufactured in more than one State, to the Secretary; or

(3) Where there is no appropriate SAA under paragraph (c)(1) of this section, to the Secretary.

However, Where only one manufactured home is involved, the manufacturer need not submit the plan if the manufacturer corrects the manufactured home within the 20 day period. The manufacturer shall maintain, in the plant where the manufactured home was manufactured, a complete record of the correction. The record shall describe briefly the facts of the case and state what corrective actions were taken, and it shall be maintained in a separate file in a form that will allow

the Secretary or an SAA to review all such corrections.

(d) Upon approval of the plan with any necessary changes, the manufacturer shall carry out the approved plan within the time limits stated in it.

(e) In any case, the manufacturer may act prior to obtaining approval of the plan. However, such action is subject to review and disapproval by the SAA of the State where the manufactured home is located, the SAA of the State where the manufactured home was manufactured, or the Secretary, except to the extent that agreement to the correction is obtained as described in this paragraph. To be assured that the corrective action will be accepted, the manufacturer may obtain the agreement of either SAA or the Secretary that the corrective action is adequate before the correction is made regardless of whether a plan has been submitted under paragraph (c) of this section. If such an agreement is obtained, the correction shall be accepted as adequate by all SAAs and the Secretary if the correction is made as agreed to and any imminent safety hazard or serious defect is eliminated.

(f) If the manufacturer wishes to obtain a waiver of the formal plan approval and notification requirements that would result from a determination under paragraph (b) of this section, the manufacturer may act under this paragraph. The plan approval and notification requirements shall be waived by either the SAA or the Secretary that would otherwise review the plan under paragraph (c) of this section if:

(1) The manufacturer, before the expiration of the time period determined under paragraph (c) of this section, shows to the satisfaction of the SAA or the Secretary, through such documentation as the SAA or the Secretary may require, that:

(i) The manufacturer has identified the class of possibly affected manufactured homes in accordance with § 3282.409.

(ii) The manufacturer will correct, at the manufacturer's expense, all affected manufactured homes in the class within 60 days of being informed that the request for waiver has been accepted; and

(iii) The proposed repairs are adequate to remove the failure to conform or imminent safety hazard that gave rise to the determination under paragraph (b) of this section; and

(2) The manufacturer corrects all affected manufactured homes within 60 days of being informed that the request for waiver has been accepted. The formal plan and notification requirements are waived pending final resolution of a waiver request under this paragraph (f) as of the date of such a request. If a waiver request is not accepted, the plan called for by paragraph (c) of this section shall be submitted within 5 days after the manufacturer is notified that the request was not accepted.

§ 3282.405 SAA responsibilities.

(a) As set out at § 3282.302(b)(5), each SAA is responsible for overseeing the handling of consumer complaints by manufacturers within the state. As part of that responsibility, the SAA is required to monitor manufacturer compliance with this subpart, and particularly with § 3282.404. This monitoring will be done primarily by periodically checking the records that manufacturers are required to keep under § 3282.404(b).

(b) If the SAA acting under paragraph (a) finds that a manufacturer has failed to comply with § 3282.404, or if the SAA finds that the manufacturer has decided not to act under § 3282.404(c) where the SAA believes the manufacturer is required to act, or if the manufacturer failed to fulfill the requirements of § 3282.404(f) after requesting a waiver under that paragraph, the SAA shall make such preliminary determinations as it deems appropriate under § 3282.407(b), except that if the affected manufactured homes were manufactured in more than one state or if it appears that the appropriate preliminary determination would be an imminent safety hazard or serious defect, the SAA shall refer the matter to the Secretary.

(c) Where an SAA that is reviewing a plan under § 3282.404(c) finds that the manufacturer is not acting reasonably in refusing to accept changes to a proposed plan, the SAA shall make such preliminary determinations as may be appropriate under § 3282.407, except that

where it appears that it would be appropriate to make a preliminary determination of imminent safety hazard or serious defect, the SAA shall refer the matter to the Secretary.

§ 3282.406 Required manufacturer correction.

A manufacturer required to furnish notification under § 3282.404 or § 3282.407 shall correct, at its expense, any imminent safety hazard or serious defect that can be related to an error in design or assembly of the manufactured home by the manufacturer, including an error in design or assembly of any component or system incorporated in the manufactured home by the manufacturer.

§ 3282.407 Notification and correction pursuant to administrative determination.

(a) *Preliminary determinations.* (1) Whenever the Secretary has information indicating the possible existence of an imminent safety hazard or serious defect in a manufactured home, the Secretary may issue a preliminary determination to that effect to the manufacturer.

(2) Whenever the information referred to in paragraph (a)(1) of this section indicates that the manufacturer is required to correct the imminent safety hazard or serious defect under § 3282.406, the Secretary may issue a preliminary determination to that effect to the manufacturer.

(3) Whenever an SAA has information indicating that a defect or noncompliance may exist in a class of manufactured homes that is identifiable because the cause of the defect or noncompliance is such that the same defect or noncompliance would probably have been systematically introduced into more than one manufactured home during the course of production, and all manufactured homes in the class appear to have been manufactured in that State, the SAA may issue a preliminary determination of defect or noncompliance to the manufacturer. Information on which an SAA may base a conclusion that an appropriate class of manufactured homes exists may include, but is not limited to, complaints that can be traced to the

same cause, defects known to exist in supplies of components or parts, information related to the performance of a particular employee, and information indicating a failure to follow quality control procedures with respect to a particular aspect of the manufactured home. If, during the course of these proceedings, evidence arises that indicates that manufactured homes in the same identifiable class were manufactured in more than one state, the SAA shall refer the matter to the Secretary. The Secretary may make a preliminary determination of noncompliance or defect where there is evidence that a noncompliance or defect may exist.

(b) *Notice and request for presentation of views and evidence.* (1) Notice of the preliminary determination shall be sent by certified mail and shall include:

(i) The factual basis for the determination and

(ii) The identifying criteria of the manufactured homes known to be affected and those believed to be in the class of possibly affected manufactured homes.

(2) The notice shall inform the manufacturer that the preliminary determination shall become final unless the manufacturer requests a hearing or presentation of views under subpart D of this part within 15 days of receipt of a Notice of Preliminary Determination of serious defect, defect, or noncompliance, or within 5 days of receipt of a Notice of Preliminary Determination of imminent safety hazard.

(3) Promptly upon receipt of a manufacturer's request, a Formal or an Informal Presentation of Views shall be held in accordance with §3282.152.

(4) Parties may propose in writing, at any time, offers of settlement which shall be submitted to and considered by the Secretary or the SAA that issued the Notice of Preliminary Determination. If determined to be appropriate, the party making the offer may be given an opportunity to make an oral presentation in support of such offer. If an offer of settlement is rejected, the party making the offer shall be so notified and the offer shall be deemed withdrawn and shall not constitute a part of the record in the proceeding. Final acceptance by the Secretary or an SAA

of any offer to settlement shall automatically terminate any proceedings related thereto.

(c) *Final determinations.* (1) If the manufacturer fails to respond to the notice of preliminary determination within the time period established in paragraph (b)(2) of this section, or if the SAA or the Secretary decides that the views and evidence presented by the manufacturer or others are insufficient to rebut the preliminary determination, the SAA or the Secretary, as appropriate, shall make a final determination that an imminent safety hazard, serious defect, defect, or noncompliance exists. In the event of a final determination that an imminent safety hazard, serious defect, defect or noncompliance exists, the SAA or the Secretary shall issue an order directing the manufacturer to furnish notification. If the Secretary makes a final determination that the manufacturer is required to correct, the Secretary shall issue an order directing the manufacturer to provide correction.

(2) *Appeals.* When an SAA has made a final determination that a defect or noncompliance exists, the manufacturer may, within 10 days after receipt of the notice of such final determination, appeal to the Secretary under §3282.309.

(d) Where a preliminary determination of defect or noncompliance has been issued, the manufacturer may, at any time during the proceedings called for in this section or after the issuance of a Final Determination and Order, request a waiver of the formal notification requirements. The manufacturer may request such a waiver from the SAA that is handling the proceedings, or if the Secretary is handling the proceedings, from the Secretary. When requesting such a waiver, the manufacturer shall certify and provide assurances that:

(1) The manufacturer has identified the class of possibly affected manufactured homes in accordance with §3282.409;

(2) The manufacturer will correct, at the manufacturer's expense, all affected manufactured homes in the class within a time period specified by the SAA or the Secretary but not later than 60 days after being informed of

the acceptance of the request for waiver or issuance of the Final Determination, whichever is later; and

(3) The proposed repairs are adequate to remove the failure to conform or imminent safety hazard that gave rise to the issuance of the Preliminary Determination.

The SAA or the Secretary may grant the request for waiver if the manufacturer agrees under paragraph (b)(4) of this section to an offer of settlement that includes an order that embodies the assurances made by the manufacturer.

[42 FR 2580, Jan. 12, 1977, as amended at 51 FR 34468, Sept. 29, 1986; 51 FR 37568, Oct. 23, 1986]

§ 3282.408 Reimbursement for prior correction by owner.

A manufacturer that is required to correct under § 3282.406 or that decides to correct and obtain a waiver under § 3282.404(f) or § 3282.407(d) shall provide reimbursement for reasonable cost of correction to any owner of an affected manufactured home who chose to make the correction before the manufacturer did so.

§ 3282.409 Manufacturer's plan for notification and correction.

(a) This section sets out the requirements that shall be met by manufacturers in preparing plans they are required to submit under § 3282.404(c). The underlying requirement is that the plan show how the manufacturer will fulfill its responsibilities with respect to notification and correction that arise under this subpart I.

(b) The plan shall include a copy of the proposed notice that meets the requirements of § 3282.410.

(c) The plan shall identify, by serial number and other appropriate identifying criteria, all manufactured homes with respect to which notification is to be provided. The class of manufactured homes with respect to which notification shall be provided and which shall be covered by the plan is that class of homes that was or is suspected of having been affected by the cause of an imminent safety hazard or failure to conform. The class is identifiable to the extent that the cause of the imminent safety hazard or failure to conform is

such that it would probably have been systematically introduced into the manufactured homes in the class during the course of production. In determining the extent of such a class, the manufacturer may rely either upon information that positively identifies the extent of the class or upon information that indicates what manufactured homes were not affected by the same cause, thereby identifying the class by excluding those manufactured homes. Methods that may be used in determining the extent of the class of manufactured homes include, but are not limited to:

(1) Inspection of manufactured homes produced before and after the manufactured homes known to be affected;

(2) Inspection of manufacturer quality control records to determine whether quality control procedures were followed;

(3) Inspection of IPIA records to determine whether the imminent safety hazard or failure to conform was either detected or specifically found not to exist in some manufactured homes;

(4) Inspection of the design of the manufactured home in question to determine whether the imminent safety hazard or failure to conform resulted from the design itself;

(5) Identification of the cause as relating to a particular employee or process that was employed for a known period of time or in producing the manufactured homes manufactured during that time;

(6) Inspection of records relating to components supplied by other parties and known to contain or suspected of containing imminent safety hazards or failures to conform.

The class of manufactured homes identified by these methods may include only manufactured homes actually affected by the imminent safety hazard or failure to conform if the manufacturer can identify the precise manufactured homes. If it is not possible to identify the precise manufactured homes, the class shall include manufactured homes suspected of containing the imminent safety hazard or failure to conform because the evidence shows that they may have been affected.

(d) The plan shall include a statement by the IPIA operating in each

§ 3282.410

24 CFR Ch. XX (4-1-11 Edition)

plant in which manufactured homes in question were produced. In this statement, the IPIA shall concur in the methods used by the manufacturer to determine the class of potentially affected manufactured homes or state why it believes the methods to have been inappropriate, inadequate, or incorrect.

(e) The plan shall include a deadline for completion of all notifications and corrections.

(f) The plan shall provide for notification to be accomplished:

(1) By certified mail or other more expeditious means to the dealers or distributors of such manufacturer to whom such manufactured home was delivered. Where a serious defect or imminent safety hazard is involved, notification shall be sent by certified mail if it is mailed; and

(2) By certified mail to the first purchaser of each manufactured home in the class of manufactured homes set out in the plan under paragraph (c) of this section, and to any subsequent owner to whom any warranty provided by the manufacturer or required by Federal, State or local law on such manufactured home has been transferred, to the extent feasible, except that notification need not be sent to any person known by the manufacturer not to own the manufactured home in question if the manufacturer has a record of a subsequent owner of the manufactured home; and

(3) By certified mail to any other person who is a registered owner of each manufactured home containing the imminent safety hazard, serious defect, defect, or noncompliance and whose name has been ascertained pursuant to § 3282.211.

§ 3282.410 Contents of notice.

Except as otherwise agreed by the Secretary or the SAA reviewing the plan under § 3282.404(c), the notification to be sent by the manufacturer shall include the following:

(a) An opening statement: “This notice is sent to you in accordance with the requirements of the National Manufactured Housing Construction and Safety Standards Act.”

(b) Except where the manufacturer is acting under § 3282.404, the following

statement, as appropriate: “(Manufacturer’s name or the Secretary, or the appropriate SAA)” has determined that:

(1) An imminent safety hazard may exist in (identifying criteria of manufactured home).

(2) A serious defect may exist in (identifying criteria of manufactured home).

(3) A defect may exist in (identifying criteria of manufactured home).

(4) (Identifying criteria of manufactured home) may not comply with an applicable “Federal Home Construction or Safety Standard.”

(c) A clear description of the imminent safety hazard, serious defect, defect, or noncompliance which shall include:

(1) The location of the imminent safety hazard, serious defect, defect, or noncompliance in the manufactured home;

(2) A description of any hazards, malfunctions, deterioration or other consequences which may result from the imminent safety hazard, serious defect, defect, or noncompliance;

(3) A statement of the conditions which may cause such consequences to arise; and

(4) Precautions, if any, that the owner should take to reduce the chance that the consequences will arise before the manufactured home is repaired.

(d) An evaluation of the risk to manufactured home occupants’ safety and the durability of the manufactured home reasonably related to such imminent safety hazard, serious defect, defect, or noncompliance, including:

(1) The type of injury which may occur to occupants of the manufactured home; and

(2) Whether there will be any warning that a dangerous occurrence may take place and what that warning would be, and any signs which the owner might see, hear, smell, or feel which might indicate danger or deterioration of the manufactured home as a result of the imminent safety hazard, serious defect, defect, or noncompliance.

(e) If the manufacturer will correct the manufactured home under this subpart or otherwise, a statement that the manufacturer will correct the manufactured home.

(f) A statement in accordance with whichever of the following is appropriate:

(1) Where the manufacturer will correct the manufactured home at no cost to the owner, the statement shall indicate how and when the correction will be done, how long the correction will take, and any other information that may be helpful to the owner.

(2) When the manufacturer does not bear the cost of repair, the notification shall include a detailed description of all parts and materials needed to make the correction, a description of all steps to be followed in making the correction including appropriate illustrations, and an estimate of the cost of the purchaser or owner of the correction.

(g) A statement informing the owner that the owner may submit a complaint to the Secretary if the owner believes that:

(1) The notification or the remedy described therein is inadequate; or

(2) The manufacturer has failed or is unable to remedy the problem in accordance with his notification; or

(3) The manufacturer has failed or is unable to remedy within a reasonable time after the owner's first attempt to obtain remedy.

(h) A statement that any actions taken by the manufacturer under the Act in no way limit the rights of the owner or any other person under any contract or other applicable law and that the owner may have further rights under contract or other applicable law.

§ 3282.411 Time for implementation.

(a) The manufacturer shall complete implementation of the plan for correction approved under § 3282.404(d) on or before the deadline established in the plan as required by § 3282.409(e). The deadline shall allow a reasonable amount of time to complete the plan, taking into account the seriousness of the problem, the number of manufactured homes involved, the immediacy of any risk, and the difficulty of completing the action. The seriousness and immediacy of any risk shall be given greater weight than other considerations. If a manufacturer is required to correct an imminent safety hazard or serious defect under § 3282.406, the dead-

line shall be no later than 60 days after approval of the plan.

(b) The manufacturer shall complete the implementation of any notifications and corrections being carried out under an order of an SAA or the Secretary under § 3282.407(c) on or before the deadline established in the order. In establishing each deadline, an SAA or the Secretary shall allow a reasonable time to complete all notifications and corrections, taking into account the seriousness of the imminent safety hazard, serious defect, defect or non-compliance, the number of manufactured homes involved, the location of the homes, and the extent of correction required, except that in no case shall the time allowed exceed the following limits:

(1) In the case of a Final Determination of imminent safety hazard, 30 days after the issuance of the Final Determination.

(2) In the case of a Final Determination of serious defect, defect or non-compliance, 60 days after the issuance of the Final Determination.

(c) An SAA that approved a plan or is handling a proceeding or the Secretary may grant an extension of the deadlines included in a plan or order if the manufacturer requests such an extension in writing and shows good cause for the extension, and the SAA or the Secretary is satisfied that the extension is justified in the public interest. When the Secretary grants an extension, the Secretary shall notify the manufacturer and shall publish notice of such extension in the FEDERAL REGISTER. When an SAA grants an extension, the SAA shall notify the manufacturer, and forward to the Secretary a draft notice of the extension to be published in the FEDERAL REGISTER.

§ 3282.412 Completion of remedial actions and report.

(a) Where a manufacturer is required to provide notification under this subpart, the manufacturer shall maintain in its files for five years from the date the notification campaign is completed a copy of the notice sent and a complete list of the people and their addresses. The files referred to in this section shall be organized such that

§ 3282.413

24 CFR Ch. XX (4-1-11 Edition)

each notification and correction campaign can be readily identified and reviewed by an SAA or the Secretary.

(b) Where a manufacturer is required to provide correction under § 3282.406 or where the manufacturer otherwise corrects under § 3282.404(f) or § 3282.407(d), the manufacturer shall maintain in its files, for five years from the date the correction campaign is completed, one of the following, as appropriate, for each manufactured home involved.

(1) Where the correction is made, a certification by the manufacturer that the repair was made to satisfy completely the standards in effect at the time the manufactured home was manufactured and that any imminent safety hazard has been eliminated, or

(2) Where the owner refuses to allow the manufacturer to repair the home, a certification by the manufacturer that the owner has been informed of the problem which may exist in the manufactured home, that the owner has been informed of any risk to safety or durability of the manufactured home which may result from the problem, and that an attempt has been made to repair the problems only to have the owner refuse the repair.

(c) If any actions taken under this subpart are not adequate under the approved plan or an order of the Secretary or an SAA, the manufacturer may be required to provide additional notifications or corrections to satisfy the plan or order.

(d) If, in the course of making corrections under any of the provisions of this subpart, the manufacturer creates an imminent safety hazard or serious defect, the manufacturer shall correct the imminent safety hazard or serious defect under § 3282.406.

(e) The manufacturer shall, within 30 days after the deadline for completing any notifications and, where required, corrections, under an approved plan or under an order of an SAA or the Secretary, or any corrections required to obtain a waiver under § 3282.404(f) or § 3282.407(d), provide a complete report of the action taken to the SAA or the Secretary that approved the plan under § 3282.404(d), granted the waiver, or issued the order under § 3282.407(c), and to any other SAA or the Secretary that forwarded a relevant complaint or in-

formation to the manufacturer under § 3282.403.

§ 3282.413 Replacement or repurchase of manufactured home from purchaser.

(a) Whenever an imminent safety hazard or serious defect which must be corrected by the manufacturer at his expense under § 3282.407 cannot be repaired within 60 days in accordance with section 615(i) of the Act, the Secretary may require:

(1) That the manufactured home be replaced by the manufacturer with a manufactured home substantially equal in size, equipment, and quality, and either new or in the same condition the defective manufactured home would have been in at the time of discovery of the imminent safety hazard or serious defect had the imminent safety hazard or serious defect not existed; or

(2) That the manufacturer take possession of the manufactured home and refund the purchase price in full, less a reasonable allowance for depreciation based on actual use if the home has been in the possession of the owner for more than one year. Such depreciation shall be based upon an appraisal system approved by the Secretary, and shall not take into account damage or deterioration resulting from the imminent safety hazard or serious defect.

(b) In determining whether to order replacement or refund by the manufacturer, the Secretary shall consider:

(1) The threat of injury or death to manufactured home occupants;

(2) Any costs and inconvenience to manufactured home owners which will result from the lack of adequate repair within the specified period;

(3) The expense to the manufacturer;

(4) Any obligations imposed on the manufacturer under contract or other applicable law of which the Secretary has knowledge; and

(5) Any other relevant factors which may be brought to the attention of the Secretary.

(c) In those situations where, under contract or other applicable law, the owner has the right of election between replacement and refund, the manufacturer shall inform the owner of such right of election and shall inform the

Secretary of the election, if any, by the owner.

(d) This section applies where an attempted correction of an imminent safety hazard or serious defect relieves the safety problem but does not bring the home in conformity to the standards.

(e) Where replacement or refund by the manufacturer is ordered under this section, it shall be carried out within 30 days of the Secretary's order to replace the manufactured home or refund the purchase price unless the Secretary, for good cause shown, grants an extension of time for implementation of such order and publishes notice of extension in the FEDERAL REGISTER.

§ 3282.414 Manufactured homes in the hands of dealers and distributors.

(a) The manufacturer is responsible for correcting any failures to conform and imminent safety hazards which exist in manufactured homes which have been sold or otherwise released to a distributor or dealer but which have not yet been sold to a purchaser. This responsibility generally does not extend to failures to conform or imminent safety hazards that result solely from transit damage that occurs after the manufactured home leaves the control of the manufacturer, unless such transit damage is reasonably foreseeable by the manufacturer when the home is released by the manufacturer. This section sets out the procedures to be followed by dealers and distributors for handling manufactured homes in such cases. Regardless of whether the manufacturer is responsible for repairing a manufactured home, no dealer or distributor may sell a manufactured home if it contains a failure to conform or an imminent safety hazard.

(b) Whenever a dealer or distributor finds a problem in a manufactured home which the manufacturer is responsible for correcting under paragraph (a) of this section, the dealer or distributor shall contact the manufacturer, provide full information concerning the problem, and request appropriate action by the manufacturer in accord with paragraph (c) of this section. Where the manufacturer agrees to correct, the manufacturer shall maintain a complete record of its

actions. Where the manufacturer authorizes the dealer to make the necessary corrections on a reimbursable basis, the dealer or distributor shall maintain a complete record of its actions. Agreement by the manufacturer to correct or to authorize corrections on a reimbursable basis under this paragraph constitutes a determination of the Secretary for purposes of section 613(b) of the Act with respect to judicial review of the amount which the manufacturer agrees to reimburse the dealer or distributor for corrections.

(c) Upon a final determination by the Secretary or a State Administration Agency under § 3282.407, or upon a determination by a court of competent jurisdiction that a manufactured home fails to conform to the standard or contains an imminent safety hazard after such manufactured home is sold or otherwise released by a manufacturer to a distributor or a dealer and prior to the sale of such manufactured home by such distributor or dealer to a purchaser, the manufacturer shall have the option to either:

(1) Immediately furnish, at the manufacturer's expense, to the purchasing distributor or dealer the required conforming part or parts or equipment for installation by the distributor or dealer on or in such manufactured home, and the manufacturer shall reimburse such distributor or dealer for the reasonable value of such installation plus a reasonable reimbursement of not less than one per centum per month of the manufacturer's or distributor's selling price prorated from the date of receipt by certified mail of notice of non-compliance to the date such manufactured home is brought into compliance with the standards, so long as the distributor or dealer proceeds with reasonable diligence with the installation after the part or component is received; or

(2) Immediately repurchase, at the manufacturer's expense, such manufactured home from such distributor or dealer at the price paid by such distributor or dealer, plus all transportation charges involved and a reasonable reimbursement of not less than one per centum per month of such price paid prorated from the date of receipt

§ 3282.415

by certified mail of notice of the imminent safety hazard, serious defect, defect or noncompliance to the distributor. The value of such reasonable reimbursements as specified in this paragraph shall be fixed by mutual agreement of the parties or by a court in an action brought under section 613(b) of the Act.

(d) This section shall not apply to any manufactured home purchased by a dealer or distributor which has been leased by such dealer or distributor to a tenant for purposes other than resale. In that instance the dealer or distributor has the remedies available to a purchaser under this subpart.

§ 3282.415 Notices, bulletins and other communications.

Each manufacturer shall, at the time of dispatch, furnish to the Secretary a true or representative copy of all notices, bulletins, and other written communications to the dealers or distributors of such manufacturer or purchasers or owners of manufactured homes of such manufacturers regarding any serious defect or imminent safety hazard which may exist in any such manufactured homes produced by such manufacturer. Manufacturers shall keep complete records of all other communications with dealers, owners, and purchasers regarding noncompliances, and defects.

§ 3282.416 Supervision of notification and correction actions.

(a) The IPIA in each manufacturing plant shall be responsible for assuring that notifications are sent to all owners, purchasers, dealers, or distributors of whom the manufacturer has knowledge under § 3282.211 or otherwise as required by these regulations, and the IFIA shall be responsible for assuring that the required corrections are carried out by auditing the certificates required by § 3282.412.

(b) The SAA or Secretary to which the report required by § 3282.412(e) is sent shall be responsible for assuring through oversight that remedial actions described in the report have been carried out as described in the report.

(c) The SAA of the state in which an affected manufactured home is located may inspect that manufactured home

24 CFR Ch. XX (4-1-11 Edition)

to determine whether any required correction is carried out to the approved plan or, if there is no plan, to the standards or other approval obtained by the manufacturer.

Subpart J—Monitoring of Primary Inspection Agencies

§ 3282.451 General.

The actions of all primary inspection agencies accepted under subpart H shall be monitored by the Secretary or the Secretary's agent to determine whether the PIAs are fulfilling their responsibilities under these regulations. This monitoring shall be carried out primarily through joint monitoring teams made up of personnel supplied by SAAs and by the Secretary or the Secretary's agent. Monitoring parties shall make recommendations to the Secretary with respect to final acceptance of PIAs under §§ 3282.361(e) and 3282.362(e), continued acceptance, and disqualification or requalification under § 3282.356, and with respect to any changes which PIAs should make in their operations in order to continue to be approved. Based on this monitoring, the Secretary shall determine whether PIAs should continue to be approved under these regulations.

§ 3282.452 Participation in monitoring.

(a) *Joint monitoring teams.* (1) The Secretary or the Secretary's agent shall develop and coordinate joint monitoring teams which shall be made up of qualified personnel provided by SAAs and by the Secretary or the Secretary's agent. The Secretary or the Secretary's agent shall determine whether personnel are qualified based on education or experience.

(2) The joint monitoring teams will operate generally on a regional basis. To the extent possible, the teams shall be so scheduled that personnel provided by an SAA will be monitoring operations in manufactured home plants from which manufactured homes are shipped into their State.

(3) Personnel from an SAA shall not participate on joint monitoring teams operating within their State.

(4) States are encouraged but not required to participate on joint monitoring teams.

(b) *State monitoring.* A State may carry out monitoring of IPIA functions at plant facilities within the State if the State is not acting as an IPIA. Where a State wishes to carry out monitoring activities it shall do so in coordination with the Secretary and the Secretary's agent. To the extent that the State is performing adequate monitoring, the frequency of the joint team monitoring may be reduced to one visit per year consistent with the requirements of § 3282.453.

(c) *Review of staff capability.* The monitoring party shall review the capability of the PIA's staff to perform the functions it is required to perform.

(d) *Review of interpretations.* The monitoring party shall review all records of interpretations of the standards made by the PIA to determine whether they are consistent and to determine whether there are any conflicts which should be referred to the Secretary for determination.

(e) *DAPIA.* Monitoring parties shall review on a random basis at least 10 percent of the design and quality assurance manual approvals made by each DAPIA in each year.

(f) *IPIA.* The monitoring parties shall assure that the IPIAs are carrying out all of the functions for which they have been accepted. In particular, they shall assure that the manufacturing process is as stated in the certification reports, that the IPIAs are carrying out the required number of inspections, that inspections are effective, and that the IPIAs are maintaining complete label control as required by § 3282.362. A monitoring team shall monitor the IPIA's office procedures, files, and label control and the monitoring team shall send copies of its report to the Secretary or the Secretary's agent, which shall send copies to all monitoring teams which monitor the operations of the subject IPIA.

(g) *Remedial actions.* The monitoring parties shall review the remedial action records of the manufacturers and of the primary inspection agencies closely to determine whether the primary inspection agencies have been carrying out their responsibilities with respect to remedial actions.

§ 3282.453 Frequency and extent of monitoring.

(a) The actions of all primary inspection agencies shall be monitored at a frequency adequate to assure that they are performing consistently and fulfilling their responsibilities under these regulations. Every aspect of the primary inspection agencies' performance shall be monitored.

(b) Frequency of monitoring. The performance of each primary inspection agency shall be monitored during its period of provisional acceptance by a complete review of its records and, in the case of IPAs, by a complete inspection of the operations of at least one manufacturing plant which it has approved or in which it is operating. After the initial inspection, the performance of each primary inspection agency shall be monitored four times per year, except that the number of monitoring visits may be decreased to a minimum of one per year if the performance of the primary inspection agency is deemed by the Secretary or the Secretary's agent to be superior, and it may be increased as necessary if performance is suspect. There shall be a minimum of one review per year of the records of each primary inspection agency, and there shall be more reviews as needed.

Subpart K—Departmental Oversight

§ 3282.501 General.

The Secretary shall oversee the performance of SAAs, the Secretary's agent, and primary inspection agencies as follows:

(a) The Secretary shall review SAA reports to ensure that States are taking appropriate actions with regard to the enforcement of the standards and with respect to the functions for which they are approved under these regulations.

(b) The Secretary shall review monitoring reports submitted by the Secretary's agent to determine that it is performing in accordance with the contract between it and the Secretary.

(c) The Secretary shall review monitoring reports to determine whether

§ 3282.502

PIAs are fulfilling their responsibilities under these regulations.

(d) The Secretary shall make random visits for the purpose of overseeing the activities of SAAs and the Secretary's agent.

(e) The Secretary shall take such other actions to oversee the system established by these regulations as it deems appropriate.

(f) All records maintained by all parties acting under these regulations with respect to those actions shall be available to the Secretary, the Secretary's agent, and where appropriate, SAAs and PIAs for review at any reasonable time.

§ 3282.502 Departmental implementation.

To the extent that SAAs or any parties contracting with the Secretary do not perform functions called for under these regulations, those functions shall be carried out by the Secretary with its own personnel or through other appropriate parties.

§ 3282.503 Determinations and hearings.

The Secretary shall make all the determinations and hold such hearings as are required by these regulations, and the Secretary shall resolve all disputes arising under these regulations.

Subpart L—Manufacturer, IPIA and SAA Reports

§ 3282.551 Scope and purpose.

This subpart describes the reports which shall be submitted by manufacturers, PIAs and SAAs as part of the system of enforcement established under these regulations. Additional reports described in subpart I are required when corrective actions are taken under that subpart.

§ 3282.552 Manufacturer reports for joint monitoring fees.

For each month, the manufacturer shall submit to the IPIA in each of its manufacturing plants a report that includes the serial numbers of each manufactured home manufactured at that plant during that preceding month, and the State of first location, after leaving the manufacturing plant, of such

24 CFR Ch. XX (4–1–11 Edition)

manufactured homes. The State of first location for the purpose of this report is the State of the premises of the distributor, dealer or purchaser to whom the manufactured home is first shipped. The report for each month shall be submitted by the tenth day of the following month.

§ 3282.553 IPIA reports.

Each IPIA shall submit by the twentieth day of each month to each SAA, or if no SAA to the Secretary, in each state where it is engaged in the inspection of manufacturing plants, a report of the operations of each manufacturer in that State for the preceding month which includes the following information:

(a) The number of single-wide and double-wide manufactured homes labeled in the preceding month;

(b) The number of inspection visits made to each manufacturing plant in the preceding month; and

(c) The number of manufactured homes with a failure to conform to the standards or an imminent safety hazard during the preceding month found in the manufacturing plant.

The manufacturers report for the preceding month described in § 3282.552 shall be attached to each such IPIA report as an appendix thereto.

§ 3282.554 SAA reports.

Each SAA shall submit, prior to the last day of each month, to the Secretary a report covering the preceding month which includes:

(a) The description and status of all presentations of views, hearings and other legal actions during the preceding month; and

(b) The description of the SAA's oversight activities and findings regarding consumer complaints, notification and correction actions during the preceding month. The IPIA report for the preceding month described in § 3282.553, as well as the reports described in § 3282.413 and manufacturer reports under § 3282.404(d), which were received during the preceding month, shall be attached to each such SAA report as an appendix thereto.

PART 3284—MANUFACTURED HOUSING PROGRAM FEE

Sec.

3284.1 Applicability.

3284.5 Amount of fee.

3284.10 Payments to States.

AUTHORITY: 42 U.S.C. 3535(d), 5419 and 5424.

SOURCE: 67 FR 52835, Aug. 13, 2002, unless otherwise noted.

§ 3284.1 Applicability.

This part applies to manufacturers that are subject to the requirements of the National Manufactured Housing Construction and Safety Standards Act of 1974 (the Act), and to States having State plans approved in accordance with the Act. The amounts established under this part for any fee collected from manufacturers will be used, to the extent approved in advance in an annual appropriations Act, to offset the expenses incurred by HUD in connection with the manufactured housing program authorized by the Act.

§ 3284.5 Amount of fee.

Each manufacturer, as defined in § 3282.7 of this chapter, must pay a fee of \$39 per transportable section of each manufactured housing unit that it manufactures under the requirements of part 3280 of this chapter.

§ 3284.10 Payments to States.

Each calendar year HUD will pay each State that, on December 27, 2000, had a State plan approved pursuant to subpart G of part 3282 of this chapter a total amount that is not less than the amount paid to that State for the 12 months ending at the close of business on December 26, 2000.

PART 3285—MODEL MANUFACTURED HOME INSTALLATION STANDARDS

Subpart A—General

Sec.

3285.1 Administration.

3285.2 Manufacturer installation instructions.

3285.3 Alterations during initial installation.

3285.4 Incorporation by reference (IBR).

3285.5 Definitions.

3285.6 Final leveling of manufactured home.

Subpart B—Pre-Installation Considerations

3285.101 Fire separation.

3285.102 Installation of manufactured homes in flood hazard areas.

3285.103 Site suitability with design zone maps.

3285.104 Moving manufactured home to location.

3285.105 Permits, other alterations, and on-site structures.

Subpart C—Site Preparation

3285.201 Soil conditions.

3285.202 Soil classifications and bearing capacity.

3285.203 Site drainage.

3285.204 Ground moisture control.

Subpart D—Foundations

3285.301 General.

3285.302 Flood hazard areas.

3285.303 Piers.

3285.304 Pier configuration.

3285.305 Clearance under homes.

3285.306 Design procedures for concrete block piers.

3285.307 Perimeter support piers.

3285.308 Manufactured piers.

3285.309 [Reserved]

3285.310 Pier location and spacing.

3285.311 Required perimeter supports.

3285.312 Footings.

3285.313 Combination systems.

3285.314 [Reserved]

3285.315 Special snow load conditions.

Subpart E—Anchorage Against Wind

3285.401 Anchoring instructions.

3285.402 Ground anchor installations.

3285.403 Sidewall, over-the-roof, mate-line, and shear wall straps.

3285.404 Severe climatic conditions.

3285.405 Severe wind zones.

3285.406 Flood hazard areas.

Subpart F—Optional Features

3285.501 Home installation manual supplements.

3285.502 Expanding rooms.

3285.503 Optional appliances.

3285.504 Skirting.

3285.505 Crawlspace ventilation.

Subpart G—Ductwork and Plumbing and Fuel Supply Systems

3285.601 Field assembly.

3285.602 Utility connections.

3285.603 Water supply.

3285.604 Drainage system.

3285.605 Fuel supply system.

§ 3285.1

24 CFR Ch. XX (4–1–11 Edition)

3285.606 Ductwork connections.

Subpart H—Electrical Systems and Equipment

3285.701 Electrical crossovers.
3285.702 Miscellaneous lights and fixtures.
3285.703 Smoke alarms.
3285.704 Telephone and cable TV.

Subpart I—Exterior and Interior Close-Up

3285.801 Exterior close-up.
3285.802 Structural interconnection of multi-section homes.
3285.803 Interior close-up.
3285.804 Bottom board repair.

Subpart J—Optional Information for Manufacturer's Installation Instructions

3285.901 General.
3285.902 Moving manufactured home to location.
3285.903 Permits, alterations, and on-site structures.
3285.904 Utility systems connection.
3285.905 Heating oil systems.
3285.906 Telephone and cable TV.
3285.907 Manufacturer additions to installation instructions.

AUTHORITY: 42 U.S.C. 3535(d), 5403, 5404, and 5424.

SOURCE: 72 FR 59362, Oct. 19, 2007, unless otherwise noted.

Subpart A—General

§ 3285.1 Administration.

(a) *Scope.* These Model Installation Standards provide minimum requirements for the initial installation of new manufactured homes, in accordance with section 605 of the Act (42 U.S.C. 5404). The Model Installation Standards are one component of the Manufactured Home Installation Program in Part 3286 of this chapter, upon effect, and serve as the basis for developing the manufacturers' installation instructions required by § 3285.2 of this subpart. The manufacturer's installation instructions, including specific methods for performing a specific operation or assembly, will be deemed to comply with these Model Installation Standards, provided they meet or exceed the minimum requirements of these Model Installation Standards and do not take the home out of compliance with the Manufactured Home Construction and Safety Standards (24

CFR part 3280). Work necessary to join all sections of a multi-section home specifically identified in Subparts G, H, and I of this part, or work associated with connecting exterior lights, chain-hung light fixtures, or ceiling-suspended fans, as specifically identified in Subpart I, is not considered assembly or construction of the home, although the design of those elements of a manufactured home must comply with the Manufactured Home Construction and Safety Standards (MHCSS). However, work associated with the completion of hinged roofs and eaves in § 3285.801 and other work done on-site and not specifically identified in this part as close-up is considered construction and assembly and is subject to the requirements of the Manufactured Home Construction and Safety Standards (24 CFR part 3280) and the Manufactured Home Procedural and Enforcement Regulations (24 CFR part 3282).

(1) States that choose to operate an installation program for manufactured homes in lieu of the federal program must implement installation standards that provide protection to its residents that equals or exceeds the protection provided by these Model Installation Standards.

(2) In states that do not choose to operate their own installation program for manufactured homes, these Model Installation Standards serve as the minimum standards for manufactured home installations.

(b) *Applicability.* The standards set forth herein have been established to accomplish certain basic objectives and are not to be construed as relieving manufacturers, retailers, installers, or other parties of responsibility for compliance with other applicable ordinances, codes, regulations, and laws. The manufactured homes covered by this standard must comply with requirements of the U.S. Department of Housing and Urban Development's (HUD) MHCSS Program, as set forth in 24 CFR part 3280, Manufactured Home Construction and Safety Standards, and 24 CFR part 3282, Manufactured Home Procedural and Enforcement Regulations, as well as with, upon effect, the Manufactured Home Installation Program, 24 CFR part 3286, and the Dispute Resolution Program, 24 CFR

part 3288. The requirements of this part do not apply to homes installed on site-built permanent foundations when the manufacturer certifies the home in accordance with § 3282.12 of this chapter.

(c) *Consultation with the Manufactured Housing Consensus Committee.* The Secretary will seek input from the Manufactured Housing Consensus Committee (MHCC) when revising the installation standards in this part 3285. Before publication of a proposed rule to revise the installation standards, the Secretary will provide the MHCC with a 120-day opportunity to comment on such revision. The MHCC may send to the Secretary any of the MHCC's own recommendations to adopt new installation standards or to modify or repeal any of the installation standards in this part. Along with each recommendation, the MHCC must set forth pertinent data and arguments in support of the action sought. The Secretary will either:

(1) Accept or modify the recommendation and publish it for public comment in accordance with section 553 of the Administrative Procedure Act (5 U.S.C. 553), along with an explanation of the reasons for any such modification; or

(2) Reject the recommendation entirely, and provide to the MHCC a written explanation of the reasons for the rejection.

§ 3285.2 Manufacturer installation instructions.

(a) *Instructions required.* A manufacturer must provide with each new manufactured home, installation designs and instructions that have been approved by the Secretary or DAPIA. The approved installation instructions must include all topics covered in the Model Installation Standards for the installation of manufactured homes. These installation instructions and any variations thereto that are prepared to comply with paragraph (c) of this section must provide protection to residents of the manufactured homes that equals or exceeds the protection provided by these Model Installation Standards and must not take the manufactured home out of compliance with the MHCSS. These instructions must insure that each home will be sup-

ported and anchored in a manner that is capable of meeting or exceeding the design loads required by the MHCSS.

(b) *Professional engineer or registered architect certification.* A professional engineer or registered architect must prepare and certify that the manufacturer's installation instructions meet or exceed the Model Installation Standards for foundation support and anchoring whenever:

(1) The manufacturer's installation instructions do not conform in their entirety to the minimum requirements or tables or their conditions for foundation support and anchoring of this Standard; or

(2) An alternative foundation system or anchoring system is employed, including designs for basements and perimeter support foundation systems, whether or not it is included in the installation instructions; or

(3) Materials such as metal piers or alternatives to concrete footing materials are required by the installation instructions; or

(4) Foundation support and anchoring systems are designed for use in areas subject to freezing or for use in areas subject to flood damage or high seismic risk; or

(5) Foundations support and anchoring systems are designed to be used in special snow load conditions or in severe wind design areas; or

(6) Site conditions do not allow the use of the manufacturer's installation instructions; or

(7) There are any other circumstances in which the manufacturer's installation instructions would not permit the home to be installed in conformance with the Installation Standards or the MHCSS.

(c) *Variations to installation instructions.* (1) Before an installer provides support or anchorage that are different than those methods specified in the manufacturer's installation instructions, or when the installer encounters site or other conditions (such as areas that are subject to flood damage or high seismic risk) that prevent the use of the instructions, the installer must:

(i) First attempt to obtain DAPIA-approved designs and instructions prepared by the manufacturer; or

§ 3285.3

(ii) If designs and instructions are not available from the manufacturer, obtain an alternate design prepared and certified by a registered professional engineer or registered architect for the support and anchorage of the manufactured home that is consistent with the manufactured home design, conforms to the requirements of the MHCSS, and has been approved by the manufacturer and the DAPIA.

(2) The manufacturer's installation instructions must include an explanation of the requirement in paragraph (c)(1) of this section.

(d) *Installer certification.* In making the certification of the installation required under part 3286 of this chapter, upon effect, an installer must certify that it completed the installation in compliance with either the manufacturer's instructions or with an alternate installation design and instructions that have been prepared by the manufacturer or prepared in compliance with paragraph (c) of this section.

(e) *Temporary storage.* The installation instructions must provide at least one method for temporarily supporting each transportable section of a manufactured home, to prevent structural and other damage to the structure, when those section(s) are temporarily sited at the manufacturer's facility, retailer's lot, or the home site.

§ 3285.3 Alterations during initial installation.

Additions, modifications, or replacement or removal of any equipment that affects the installation of the home made by the manufacturer, retailer, or installer prior to completion of the installation by an installer must equal or exceed the protections and requirements of these Model Installation Standards, the MHCSS (24 CFR part 3280) and the Manufactured Home Procedural and Enforcement Regulations (24 CFR part 3282). An alteration, as defined in § 3282.7 of this chapter, must not affect the ability of the basic manufactured home to comply with the MHCSS, and the alteration must not impose additional loads to the manufactured home or its foundation, unless the alteration is included in the manufacturer's DAPIA-approved designs and installation instructions, or is designed

24 CFR Ch. XX (4-1-11 Edition)

by a registered professional engineer or architect consistent with the manufacturer's design and that conforms to the requirements of the MHCSS.

§ 3285.4 Incorporation by reference (IBR).

(a) The materials listed in this section are incorporated by reference in the corresponding sections noted. These incorporations by reference were approved by the Director of the Federal Register, in accordance with 5 U.S.C. 552(a) and 1 CFR part 51. The materials are available for purchase at the corresponding addresses noted below, and all are available for inspection at the Office of Manufactured Housing Programs, U.S. Department of Housing and Urban Development, 451 Seventh Street, SW., Room 9164, Washington, DC 20410; or the National Archives and Records Administration (NARA). For information on the availability of this material at NARA, call (202) 741-6030, or go to: <http://www.archives.gov/federal-register/cfr/ibr-locations.html>.

(b) The materials listed below are available for purchase from the Air Conditioning Contractors of America (ACCA), 2800 Shirlington Road, Suite 300, Arlington, Virginia 22206.

(1) ACCA Manual J, Residential Load Calculation, 8th Edition, IBR approved for § 3285.503(a)(1)(i)(A).

(2) [Reserved]

(c) The materials listed below are available for purchase from APA—The Engineered Wood Association, 7011 South 19th Street, Tacoma, Washington 98411, telephone number (253) 565-6600, fax number (253) 565-7265.

(1) PS1-95, Construction and Industrial Plywood (with typical APA trademarks), 1995 edition, IBR approved for § 3285.312(a)(2)(i).

(2) [Reserved]

(d) The materials listed below are available for purchase from American Society of Heating, Refrigerating and Air Conditioning Engineers (ASHRAE), 1791 Tullie Circle, NE., Atlanta, Georgia 30329-2305.

(1) ASHRAE Handbook of Fundamentals, 1997 Inch-Pound Edition, IBR approved for § 3285.503(a)(1)(i)(A).

(2) [Reserved]

(e) The materials listed below are available for purchase from American

Society for Testing and Materials (ASTM), 100 Barr Harbor Drive, West Conshohocken, Pennsylvania 19428-2959.

(1) ASTM C 90-02a, Standard Specification for Loadbearing Concrete Masonry Units, 2002, IBR approved for § 3285.312(a)(1)(i).

(2) ASTM D 1586-99, Standard Test Method for Penetration Test and Split-Barrel Sampling of Soils, 1999, IBR approved for the table at § 3285.202(c).

(3) ASTM D 2487-00, Standard Practice for Classification of Soils for Engineering Purposes (Unified Soil Classification System), 2000, IBR approved for the table at § 3285.202(c).

(4) ASTM D 2488-00, Standard Practice for Description and Identification of Soils (Visual-Manual Procedure), 2000, IBR approved for the table at § 3285.202(c).

(5) ASTM D 3953-97, Standard Specification for Strapping, Flat Steel and Seals, 1997, IBR approved for § 3285.402(b)(2) and Note 10 to Table 1 to § 3285.402.

(f) The materials listed below are available for purchase from American Wood-Preservers' Association (AWPA), P.O. Box 388, Selma, Alabama 36702.

(1) AWPA M4-02, Standard for the Care of Preservative-Treated Wood Products, 2002, IBR approved for § 3285.312(a)(2)(iii).

(2) AWPA U1-04, Use Category System; User Specification for Treated Wood, 2004, IBR approved for §§ 3285.303(b)(1), 3285.312(a)(2)(ii), and 3285.504(c).

(g) The materials listed below are available for purchase from the Federal Emergency Management Administration (FEMA), 500 C Street, SW., Washington, DC 20472.

(1) FEMA 85/September 1985, Manufactured Home Installation in Flood Hazard Areas, 1985, IBR approved for § 3285.102(d)(3).

(2) [Reserved]

(h) The materials listed below are available for purchase from the National Fire Protection Association (NFPA), 1 Batterymarch Park, Quincy, Massachusetts 02169-7471.

(1) NFPA 31, Standard for the Installation of Oil Burning Equipment, 2001 edition, IBR approved for §§ 3285.905(a) and 3285.905(d)(3).

(2) NFPA 70, National Electrical Code, 2005 edition, IBR approved for §§ 3285.702(e)(1) and 3285.906.

(3) NFPA 501A, Standard for Fire Safety Criteria for Manufactured Home Installations, Sites, and Communities, 2003 edition, IBR approved for § 3285.101.

(i) The materials listed below are available for purchase from the Structural Engineering Institute/American Society of Civil Engineers (SEI/ASCE), 1801 Alexander Bell Drive, Reston, Virginia 20191.

(1) SEI/ASCE 32-01, Design and Construction of Frost-Protected Shallow Foundations, 2001, IBR approved for §§ 3285.312(b)(2)(ii) and 3285.312(b)(3)(ii).

(2) [Reserved]

(j) The materials listed below are available for purchase from Underwriters Laboratories (UL), 333 Pfingsten Road, Northbrook, Illinois 60062.

(1) UL 181A, Closure Systems for Use With Rigid Air Ducts and Air Connectors, 1994, with 1998 revisions, IBR approved for § 3285.606(a).

(2) UL 181B, Closure Systems for Use With Flexible Air Ducts and Air Connectors, 1995, with 1998 revisions, IBR approved for § 3285.606(a).

§ 3285.5 Definitions.

The definitions contained in this section apply to the terms used in these Model Installation Standards. Where terms are not included, common usage of the terms applies. The definitions are as follows:

Act. The National Manufactured Housing Construction and Safety Standards Act of 1974, 42 U.S.C. 5401-5426.

Anchor assembly. Any device or other means designed to transfer home anchoring loads to the ground.

Anchoring equipment. Ties, straps, cables, turnbuckles, chains, and other approved components, including tensioning devices that are used to secure a manufactured home to anchor assemblies.

Anchoring system. A combination of anchoring equipment and anchor assemblies that will, when properly designed and installed, resist the uplift, overturning, and lateral forces on the manufactured home and on its support and foundation system.

Approved. When used in connection with any material, appliance or construction, means complying with the requirements of the Department of Housing and Urban Development.

Arid region. An area subject to 15 inches or less of annual rainfall.

Base flood. The flood having a one percent chance of being equaled or exceeded in any given year.

Base flood elevation (BFE). The elevation of the base flood, including wave height, relative to the datum specified on a LAHJ's flood hazard map.

Comfort cooling certificate. A certificate permanently affixed to an interior surface of the home specifying the factory design and preparations for air conditioning the manufactured home.

Crossovers. Utility interconnections in multi-section homes that are located where the sections are joined. Crossover connections include heating and cooling ducts, electrical circuits, water pipes, drain plumbing, and gas lines.

Design Approval Primary Inspection Agency (DAPIA). A state or private organization that has been accepted by the Secretary in accordance with the requirements of Part 3282, Subpart H of this chapter, which evaluates and approves or disapproves manufactured home designs and quality control procedures.

Diagonal tie. A tie intended to resist horizontal or shear forces, but which may resist vertical, uplift, and overturning forces.

Flood hazard area. The greater of either: The special flood hazard area shown on the flood insurance rate map; or the area subject to flooding during the design flood and shown on a LAHJ's flood hazard map, or otherwise legally designated.

Flood hazard map. A map delineating the flood hazard area and adopted by a LAHJ.

Footing. That portion of the support system that transmits loads directly to the soil.

Foundation system. A system of support that is capable of transferring all design loads to the ground, including elements of the support system, as defined in this section, or a site-built permanent foundation that meets the requirements of 24 CFR 3282.12.

Ground anchor. A specific anchoring assembly device designed to transfer home anchoring loads to the ground.

Installation instructions. DAPIA-approved instructions provided by the home manufacturer that accompany each new manufactured home and detail the home manufacturer requirements for support and anchoring systems, and other work completed at the installation site to comply with these Model Installation Standards and the Manufactured Home Construction and Safety Standards in 24 CFR part 3280.

Installation standards. Reasonable specifications for the installation of a new manufactured home, at the place of occupancy, to ensure proper siting; the joining of all sections of the home; and the installation of stabilization, support, or anchoring systems.

Labeled. A label, symbol, or other identifying mark of a nationally recognized testing laboratory, inspection agency, or other organization concerned with product evaluation that maintains periodic inspection of production of labeled equipment or materials, and by whose labeling is indicated compliance with nationally recognized standards or tests to determine suitable usage in a specified manner.

Listed or certified. Included in a list published by a nationally recognized testing laboratory, inspection agency, or other organization concerned with product evaluation that maintains periodic inspection of production of listed equipment or materials, and whose listing states either that the equipment or material meets nationally recognized standards or has been tested and found suitable for use in a specified manner.

Local authority having jurisdiction (LAHJ). The state, city, county, city and county, municipality, utility, or organization that has local responsibilities and requirements that must be complied with during the installation of a manufactured home.

Lowest floor. The floor of the lowest enclosed area of a manufactured home. An unfinished or flood-resistant enclosure, used solely for vehicle parking, home access, or limited storage, must not be considered the lowest floor, provided the enclosed area is not constructed so as to render the home in

violation of the flood-related provisions of this standard.

Manufactured home. A structure, transportable in one or more sections, which in the traveling mode is 8 body feet or more in width or 40 body feet or more in length, or which when erected on site is 320 or more square feet, and which is built on a permanent chassis and designed to be used as a dwelling with or without a permanent foundation when connected to the required utilities, and includes the plumbing, heating, air-conditioning, and electrical systems contained in the structure. This term includes all structures that meet the above requirements, except the size requirements and with respect to which the manufacturer voluntarily files a certification, pursuant to § 3282.13 of this chapter, and complies with the MHCSS set forth in part 3280 of this chapter. The term does not include any self-propelled recreational vehicle. Calculations used to determine the number of square feet in a structure will include the total of square feet for each transportable section comprising the completed structure and will be based on the structure's exterior dimensions measured at the largest horizontal projections when erected on-site. These dimensions will include all expandable rooms, cabinets, and other projections containing interior space, but do not include bay windows. Nothing in this definition should be interpreted to mean that a manufactured home necessarily meets the requirements of HUD's Minimum Property Standards (HUD Handbook 4900.1) or that it is automatically eligible for financing under 12 U.S.C. 1709(b) certification.

Manufactured Home Construction and Safety Standards or MHCSS. The Manufactured Home Construction and Safety Standards established in part 3280 of this chapter, pursuant to section 604 of the Act, 42 U.S.C. 5403.

Manufactured home gas supply connector. A listed connector designed for connecting the manufactured home to the gas supply source.

Manufactured home site. A designated parcel of land designed for the installation of one manufactured home for the exclusive use of the occupants of the home.

Manufactured Housing Consensus Committee or MHCC. The consensus committee established pursuant to section 604(a)(3) of the Act, 42 U.S.C. 5403(a)(3).

Model Installation Standards. The installation standards established in part 3285 of this chapter, pursuant to section 605 of the Act, 42 U.S.C. 5404.

Pier. That portion of the support system between the footing and the manufactured home, exclusive of shims. Types of piers include, but are not limited to: Manufactured steel stands; pressure-treated wood; manufactured concrete stands; concrete blocks; and portions of foundation walls.

Ramada. Any freestanding roof or shade structure, installed or erected above a manufactured home or any portion thereof.

Secretary. The Secretary of Housing and Urban Development, or an official of HUD delegated the authority of the Secretary with respect to the Act.

Skirting. A weather-resistant material used to enclose the perimeter, under the living area of the home, from the bottom of the manufactured home to grade.

Stabilizing devices. All components of the anchoring and support systems, such as piers, footings, ties, anchoring equipment, anchoring assemblies, or any other equipment, materials, and methods of construction, that support and secure the manufactured home to the ground.

State. Each of the several states, the District of Columbia, the Commonwealth of Puerto Rico, Guam, the Virgin Islands, and American Samoa.

Support system. Pilings, columns, footings, piers, foundation walls, shims, and any combination thereof that, when properly installed, support the manufactured home.

Tie. Straps, cable, or securing devices used to connect the manufactured home to anchoring assemblies.

Ultimate load. The absolute maximum magnitude of load that a component or system can sustain, limited only by failure.

Utility connection. The connection of the manufactured home to utilities that include, but are not limited to, electricity, water, sewer, gas, or fuel oil.

§ 3285.6

Vertical tie. A tie intended to resist uplifting and overturning forces.

Wind zone. The areas designated on the Basic Wind Zone Map, as further defined in §3280.305(c) of the Manufactured Home Construction and Safety Standards in this chapter, which delineate the wind design load requirements.

Working load. The maximum recommended load that may be exerted on a component or system determined by dividing the ultimate load of a component or system by an appropriate factor of safety.

§ 3285.6 Final leveling of manufactured home.

The manufactured home must be adequately leveled prior to completion of the installation, so that the home's performance will not be adversely affected. The home will be considered adequately leveled if there is no more than ¼ inch difference between adjacent pier supports (frame or perimeter) and the exterior doors and windows of the home do not bind and can be properly operated.

Subpart B—Pre-Installation Considerations

§ 3285.101 Fire separation.

Fire separation distances must be in accordance with the requirements of Chapter 6 of NFPA 501A, 2003 edition (incorporated by reference, see §3285.4) or the requirements of the LAHJ. The installation instructions must clearly indicate this requirement in a separate section and must caution installers to take into account any local requirements on fire separation.

§ 3285.102 Installation of manufactured homes in flood hazard areas.

(a) *Definitions.* Except to the extent otherwise defined in Subpart A, the terms used in this subpart are as defined in 44 CFR 59.1 of the National Flood Insurance Program (NFIP) regulations.

(b) *Applicability.* The provisions of this section apply to the initial installation of new manufactured homes located wholly or partly within a flood hazard area.

24 CFR Ch. XX (4–1–11 Edition)

(c) *Pre-installation considerations.* Prior to the initial installation of a new manufactured home, the installer is responsible for determining whether the manufactured home site lies wholly or partly within a special flood hazard area as shown on the LAHJ's Flood Insurance Rate Map, Flood Boundary and Floodway Map, or Flood Hazard Boundary Map, or if no LAHJ, in accordance with NFIP regulations. If so located, and before an installation method is agreed upon, the map and supporting studies adopted by the LAHJ must be used to determine the flood hazard zone and base flood elevation at the site.

(d) *General elevation and foundation requirements—(1) Methods and practices.* Manufactured homes located wholly or partly within special flood hazard areas must be installed on foundations engineered to incorporate methods and practices that minimize flood damage during the base flood, in accordance with the requirements of the LAHJ, 44 CFR 60.3(a) through (e), and other provisions of 44 CFR referenced by those paragraphs.

(2) *Outside appliances.* (i) Appliances installed on the manufactured home site in flood hazard areas must be anchored and elevated to or above the same elevation as the lowest elevation of the lowest floor of the home.

(ii) Appliance air inlets and exhausts in flood hazard areas must be located at or above the same elevation as the lowest elevation of the lowest floor of the home.

(3) *Related guidance.* Refer to FEMA 85/September 1985, *Manufactured Home Installation in Flood Hazard Areas, 1985* (incorporated by reference, see §3285.4).

§ 3285.103 Site suitability with design zone maps.

Prior to the initial installation of a new manufactured home and as part of making the certification of the installation required under part 3286, upon effect, the installer is to verify that the design and construction of the manufactured home, as indicated on the design zone maps provided with the home, are suitable for the site location where the home is to be installed. The

design zone maps are those identified in part 3280 of this chapter.

(a) *Wind zone.* Manufactured homes must not be installed in a wind zone that exceeds the design wind loads for which the home has been designed, as evidenced by the wind zone indicated on the home's data plate and as further defined by counties or local governments within affected states, as applicable, in § 3280.305(c)(2) of the Manufactured Home Construction and Safety Standards in this chapter.

(b) *Roof load zone.* Manufactured homes must not be located in a roof load zone that exceeds the design roof load for which the home has been designed, as evidenced by the roof load zone indicated on the home's data plate and as further defined by counties or local governments within affected states, as applicable, in § 3280.305(c)(3) of the Manufactured Home Construction and Safety Standards in this chapter. Refer to § 3285.315 for Special Snow Load Conditions.

(c) *Thermal zone.* Manufactured homes must not be installed in a thermal zone that exceeds the thermal zone for which the home has been designed, as evidenced by the thermal zone indicated on the heating/cooling certificate and insulation zone map and as further defined by counties or local governments within affected states, as applicable, in § 3280.504(b)(5) of the Manufactured Home Construction and Safety Standards in this chapter. The manufacturer may provide the heating/cooling information and insulation zone map on the home's data plate.

§ 3285.104 Moving manufactured home to location.

Refer to § 3285.902 for considerations related to moving the manufactured home to the site of installation.

§ 3285.105 Permits, other alterations, and on-site structures.

Refer to § 3285.903 for considerations related to permitting, other alterations, and on-site structures.

Subpart C—Site Preparation

§ 3285.201 Soil conditions.

To help prevent settling or sagging, the foundation must be constructed on firm, undisturbed soil or fill compacted to at least 90 percent of its maximum relative density. All organic material such as grass, roots, twigs, and wood scraps must be removed in areas where footings are to be placed. After removal of organic material, the home site must be graded or otherwise prepared to ensure adequate drainage, in accordance with § 3285.203.

§ 3285.202 Soil classifications and bearing capacity.

The soil classification and bearing capacity of the soil must be determined before the foundation is constructed and anchored. The soil classification and bearing capacity must be determined by one or more of the following methods, unless the soil bearing capacity is established as permitted in paragraph (f) of this section:

(a) *Soil tests.* Soil tests that are in accordance with generally accepted engineering practice; or

(b) *Soil records.* Soil records of the applicable LAHJ; or

(c) *Soil classifications and bearing capacities.* If the soil class or bearing capacity cannot be determined by test or soil records, but its type can be identified, the soil classification, allowable pressures, and torque values shown in Table to § 3285.202 may be used.

(d) A pocket penetrometer; or

(e) In lieu of determining the soil bearing capacity by use of the methods shown in the table, an allowable pressure of 1,500 psf may be used, unless the site-specific information requires the use of lower values based on soil classification and type.

(f) If the soil appears to be composed of peat, organic clays, or uncompacted fill, or appears to have unusual conditions, a registered professional geologist, registered professional engineer, or registered architect must determine the soil classification and maximum allowable soil bearing capacity.

TABLE TO § 3285.202

Soil classification		Soil description	Allowable soil bearing pressure (psf) ¹	Blow count ASTM D 1586-99	Torque probe ³ value ⁴ (inch-pounds)-
Classification number	ASTM D 2487-00 or D 2488-00 (incorporated by reference, see § 3285.4)				
1		Rock or hard pan	4000+		
2	GW, GP, SW, SP, GM, SM	Sandy gravel and gravel; very than dense and/or cemented sands; coarse gravel/cobbles; preloaded silts, clays and coral.	2000	40+	More than 550.
3	GC, SC, ML, CL	Sand; silty sand; clayey sand; silty gravel; medium dense coarse sands; sandy gravel; and very stiff silt, sand clays.	1500	24-39	351-550.
4A	CG, MH ²	Loose to medium dense sands; firm to stiff clays and silts; alluvial fills.	1000	18-23	276-350.
4B	CH, MH ²	Loose sands; firm clays; alluvial fills	1000	12-17	175-275.
5	OL, OH, PT	Uncompacted fill; peat; organic clays	Refer to § 3285.202(e).	0-11	Less than 175.

Notes:
¹ The values provided in this table have not been adjusted for overburden pressure, embedment depth, water table height, or settlement problems.
² For soils classified as CH or MH, without either torque probe values or blow count test results, selected anchors must be rated for a 4B soil.
³ The torque test probe is a device for measuring the torque value of soils to assist in evaluating the holding capacity of the soil in which the ground anchor is placed. The shaft must be of suitable length for the full depth of the ground anchor.
⁴ The torque value is a measure of the load resistance provided by the soil when subject to the turning or twisting force of the probe.

§ 3285.203 Site Drainage.

(a) *Purpose.* Drainage must be provided to direct surface water away from the home to protect against erosion of foundation supports and to prevent water build-up under the home, as shown in Figure to § 3285.203.
 (b) The home site must be graded as shown in Figure to § 3285.203, or other methods, such as a drain tile and automatic sump pump system, must be provided to remove any water that may collect under the home.
 (c) All drainage must be diverted away from the home and must slope a minimum of one-half inch per foot away from the foundation for the first ten feet. Where property lines, walls, slopes, or other physical conditions prohibit this slope, the site must be

provided with drains or swales or otherwise graded to drain water away from the structure, as shown in Figure to § 3285.203.
 (d) *Sloped site considerations.* The home, where sited, must be protected from surface runoff from the surrounding area.
 (e) Refer to § 3285.902 regarding the use of drainage structures to drain surface runoff.
 (f) *Gutters and downspouts.* Manufacturers must specify in their installation instructions whether the home is suitable for the installation of gutters and downspouts. If suitable, the installation instructions must indicate that when gutters and downspouts are installed, the runoff must be directed away from the home.

Figure to § 3285.203 - Grading and drainage.

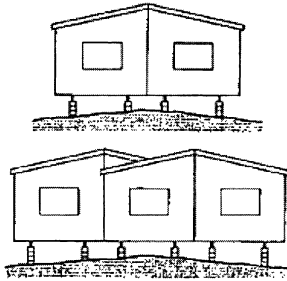

Crown and grade site to slope away from the home

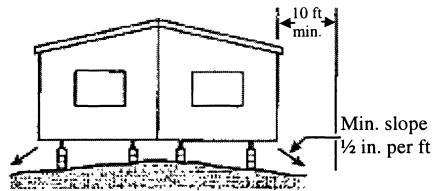

Home sites must be prepared so that there will be no depressions in which surface water may accumulate beneath the home. The area of the site covered by the manufactured home must be graded, sloped, or designed to provide drainage from beneath the home or to the property line.

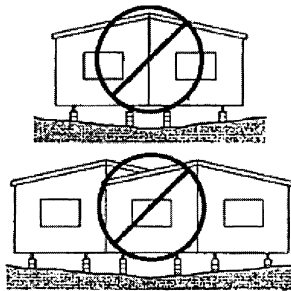

Do not grade site or set the home so that water collects beneath the home.

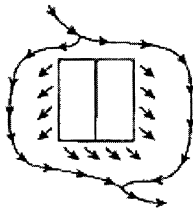

Natural drainage must be diverted around and away from the home.

§ 3285.204 Ground moisture control.

(a) *Vapor retarder.* If the space under the home is to be enclosed with skirting or other materials, a vapor retarder must be installed to cover the ground under the home, unless the home is installed in an arid region with dry soil conditions.

(b) *Vapor retarder material.* A minimum of six mil polyethylene sheeting or its equivalent must be used.

(c) *Proper installation.* (1) The entire area under the home must be covered with the vapor retarder, as noted in § 3285.204(a), except for areas under open porches, decks, and recessed entries. Joints in the vapor retarder must be overlapped at least 12 inches.

(2) The vapor retarder may be placed directly beneath footings, or otherwise installed around or over footings placed at grade, and around anchors or other obstructions.

(3) Any voids or tears in the vapor retarder must be repaired. At least one repair method must be provided in the manufacturer's installation instructions.

Subpart D—Foundations**§ 3285.301 General.**

(a) Foundations for manufactured home installations must be designed and constructed in accordance with this subpart and must be based on site conditions, home design features, and the loads the home was designed to withstand, as shown on the home's data plate.

(b) Foundation systems that are not pier and footing type configurations may be used when verified by engineering data and designed in accordance with § 3285.301(d), consistent with the design loads of the MHCSS. Pier and footing specifications that are different than those provided in this subpart, such as block size, metal piers, section width, loads, and spacing, may be used when verified by engineering data that comply with §§ 3285.301(c) and (d) and are capable of resisting all design loads of the MHCSS.

(c) All foundation details, plans, and test data must be designed and certified by a registered professional engineer or registered architect, and must

not take the home out of compliance with the MHCSS. (See 3285.2)

(d) Alternative foundation systems or designs are permitted in accordance with either of the following:

(1) Systems or designs must be manufactured and installed in accordance with their listings by a nationally recognized testing agency, based on a nationally recognized testing protocol; or

(2) System designs must be prepared by a professional engineer or a registered architect or tested and certified by a professional engineer or registered architect in accordance with acceptable engineering practice and must be manufactured and installed so as not to take the home out of compliance with the Manufactured Home Construction and Safety Standards (part 3280 of this chapter).

§ 3285.302 Flood hazard areas.

In flood hazard areas, foundations, anchorings, and support systems must be capable of resisting loads associated with design flood and wind events or combined wind and flood events, and homes must be installed on foundation supports that are designed and anchored to prevent floatation, collapse, or lateral movement of the structure. Manufacturer's installation instructions must indicate whether:

(a) The foundation specifications have been designed for flood-resistant considerations, and, if so, the conditions of applicability for velocities, depths, or wave action; or

(b) The foundation specifications are not designed to address flood loads.

§ 3285.303 Piers.

(a) *General.* The piers used must be capable of transmitting the vertical live and dead loads to the footings or foundation.

(b) *Acceptable piers—materials specification.* (1) Piers are permitted to be concrete blocks; pressure-treated wood with a water borne preservative, in accordance with AWWPA Standard U1-04 (incorporated by reference, see § 3285.4) for Use Category 4B ground contact applications; or adjustable metal or concrete piers.

(2) Manufactured piers must be listed or labeled for the required vertical load

capacity, and, where required by design, for the appropriate horizontal load capacity.

(c) *Design requirements.* (1) *Load-bearing capacity.* The load bearing capacity for each pier must be designed to include consideration for the dimensions of the home, the design dead and live loads, the spacing of the piers, and the way the piers are used to support the home.

(2) Center beam/mating wall support must be required for multi-section homes and designs must be consistent with Tables 2 and 3 to §3285.303 and Figures A, B, and C to §3285.310.

(d) *Pier loads.* (1) Design support configurations for the pier loads, pier spacing, and roof live loads must be in accordance with Tables 1, 2, and 3 to §3285.303 and the MHCSS. Other pier designs are permitted in accordance with the provisions of this subpart.

(2) Manufactured piers must be rated at least to the loads required to safely support the dead and live loads, as required by §3285.301, and the installation instructions for those piers must be consistent with Tables 1, 2, and 3 to this section.

TABLE 1 TO § 3285.303—FRAME BLOCKING ONLY/PERIMETER SUPPORT NOT REQUIRED EXCEPT AT OPENINGS

Pier spacing	Roof live load (psf)	Location	Load (lbs.)
4 ft. 0 in.	20	Frame	2,900
	30	Frame	3,300
	40	Frame	3,600
6 ft. 0 in.	20	Frame	4,200
	30	Frame	4,700
	40	Frame	5,200
8 ft. 0 in.	20	Frame	5,500
	30	Frame	6,200
	40	Frame	6,900
10 ft. 0 in.	20	Frame	6,800
	30	Frame	7,600
	40	Frame	8,500

NOTES:

- See Table to §3285.312 for cast-in-place footing design by using the noted loads.
- Table 1 is based on the following design assumptions: maximum 16 ft. nominal section width (15 ft. actual width), 12" eave, 10" I-beam size, 300 lbs. pier dead load, 10 psf roof dead load, 6 psf floor dead load, 35 plf wall dead load, and 10 plf chassis dead load.
- Interpolation for other pier spacing is permitted.

4. The pier spacing and loads shown in the above table do not consider flood or seismic loads and are not intended for use in flood or seismic hazard areas. In those areas, the foundation support system is to be designed by a professional engineer or architect.

5. See Table to §3285.312 for sizing of footings.

TABLE 2 TO § 3285.303—FRAME PLUS PERIMETER BLOCKING/PERIMETER BLOCKING REQUIRED

Maximum pier spacing	Roof live load (psf)	Location	Load (lbs.)
4 ft. 0 in.	20	Frame	1,400
		Perimeter	1,900
		Mating	3,200
4 ft. 0 in.	30	Frame	1,400
		Perimeter	2,300
		Mating	3,800
4 ft. 0 in.	40	Frame	1,400
		Perimeter	2,600
		Mating	4,400
6 ft. 0 in.	20	Frame	1,900
		Perimeter	2,700
		Mating	4,700
6 ft. 0 in.	30	Frame	1,900
		Perimeter	3,200
		Mating	5,600
6 ft. 0 in.	40	Frame	1,900
		Perimeter	3,700
		Mating	6,500
8 ft. 0 in.	20	Frame	2,400
		Perimeter	3,500
		Mating	6,100
8 ft. 0 in.	30	Frame	2,400
		Perimeter	4,200
		Mating	7,300
8 ft. 0 in.	40	Frame	2,400
		Perimeter	4,800
		Mating	8,500
10 ft. 0 in.	20	Frame	2,900
		Perimeter	4,300
		Mating	7,600
10 ft. 0 in.	30	Frame	2,900
		Perimeter	5,100
		Mating	9,100
10 ft. 0 in.	40	Frame	2,900
		Perimeter	6,000
		Mating	10,600

NOTES:

- See Table to §3285.312 for cast-in-place footing design by using the noted loads.
- Mating wall perimeter piers and footings only required under full height mating walls supporting roof loads. Refer to Figures A and B to §3285.310.
- Table 2 is based on the following design assumptions: maximum 16 ft. nominal section width (15 ft. actual width), 12" eave, 10"

§ 3285.304

I-beam size, 300 lbs. pier dead load, 10 psf roof dead load, 6 psf floor dead load, 35 plf wall dead load, and 10 plf chassis dead load.

4. Interpolation for other pier spacing is permitted.

5. The pier spacing and loads shown in the above table do not consider flood or seismic loads and are not intended for use in flood or seismic hazard areas. In those areas, the foundation support system is to be designed by a professional engineer or architect.

6. See Table to §3285.312 for sizing of footings.

6. See Table to §3285.312 for sizing of footings.

§ 3285.304 Pier configuration.

(a) *Concrete blocks.* Installation instructions for concrete block piers must be developed in accordance with the following provisions and must be consistent with Figures A and B to §3285.306.

(1) Load-bearing (not decorative) concrete blocks must have nominal dimensions of at least 8 inches × 8 inches × 16 inches;

(2) The concrete blocks must be stacked with their hollow cells aligned vertically; and

(3) When piers are constructed of blocks stacked side-by-side, each layer must be at right angles to the preceding one, as shown in Figure B to §3285.306.

(b) *Caps.* (1) Structural loads must be evenly distributed across capped-hollow block piers, as shown in Figures A and B to §3285.306.

(2) Caps must be solid concrete or masonry at least 4 inches in nominal thickness, or hardboard lumber at least 2 inches nominal in thickness; or be corrosion-protected minimum one-half inch thick steel; or be of other listed materials.

(3) All caps must be of the same length and width as the piers on which they rest.

(4) When split caps are used on double-stacked blocks, the caps must be installed with the long dimension across the joint in the blocks below.

(c) *Gaps.* Any gaps that occur during installation between the bottom of the main chassis beam and foundation support system must be filled by:

(1) Nominal 4 inch × 6 inch × 1 inch shims to level the home and fill any gaps between the base of the main chassis beam and the top of the pier cap;

(2) Shims must be used in pairs, as shown in Figures A and B to §3285.306, and must be driven in tightly so that they do not occupy more than one inch of vertical height; and

(3) Hardwood plates no thicker than 2 inches nominal in thickness or 2 inch or 4 inch nominal concrete block must be used to fill in any remaining vertical gaps.

TABLE 3 TO § 3285.303—RIDGE BEAM SPAN FOOTING CAPACITY

Mating wall opening (ft)	Roof live load (psf)	Pier and footing load (lbs.)
5	20	1,200
	30	1,600
	40	1,900
10	20	2,300
	30	3,100
	40	3,800
15	20	3,500
	30	4,700
	40	5,800
20	20	4,700
	30	6,200
	40	7,500
25	20	5,800
	30	7,800
	40	9,700
30	20	7,000
	30	9,300
	40	11,600
35	20	8,100
	30	10,900
	40	13,600

NOTES:

1. See Table to §3285.312 for cast-in-place footing design by using the noted loads.

2. Table 3 is based on the following design assumptions: maximum 16 ft. nominal section width (15 ft. actual width), 10" I-beam size, 300 lbs. pier dead load, 10 psf roof dead load, 6 psf floor dead load, 35 plf wall dead load, and 10 plf chassis dead load.

3. Loads listed are maximum column loads for each section of the manufactured home.

4. Interpolation for maximum allowable pier and column loads is permitted for mate-line openings between those shown in the table.

5. The pier spacing and loads shown in the above table do not consider flood or seismic loads and are not intended for use in flood or seismic hazard areas. In those areas, the foundation support system must be designed by a professional engineer or registered architect.

(d) *Manufactured pier heights.* Manufactured pier heights must be selected so that the adjustable risers do not extend more than 2 inches when finally positioned.

§ 3285.305 Clearance under homes.

A minimum clearance of 12 inches must be maintained between the lowest member of the main frame (I-beam or channel beam) and the grade under all areas of the home.

§ 3285.306 Design procedures for concrete block piers.

(a) *Frame piers less than 36 inches high.*

(1) Frame piers less than 36 inches high are permitted to be constructed of single, open, or closed-cell concrete blocks, 8 inches " 8 inches " 16 inches, when the design capacity of the block is not exceeded.

(2) The frame piers must be installed so that the long sides are at right angles to the supported I-beam, as shown in Figure A to this section.

(3) The concrete blocks must be stacked with their hollow cells aligned vertically and must be positioned at right angles to the footings.

(4) Horizontal offsets from the top to the bottom of the pier must not exceed one-half inch.

(5) Mortar is not required, unless specified in the installation instructions or required by a registered professional engineer or registered architect.

(b) *Frame piers 36 inches to 67 inches high and corner piers.*

(1) All frame piers between 36 inches and 67 inches high and all corner piers over three blocks high must be constructed out of double, interlocked concrete blocks, as shown in Figure B to this section, when the design capacity of the block is not exceeded. Mortar is not required for concrete block piers, unless otherwise specified in the installation instructions or required by a professional engineer or registered architect.

(2) Horizontal offsets from the top to the bottom of the pier must not exceed one inch.

(c) *All piers over 67 inches high.* Piers over 67 inches high must be designed by a registered professional engineer or registered architect, in accordance with acceptable engineering practice. Mortar is not required for concrete block piers, unless otherwise specified in the manufacturer installation instructions or by the design.

Figure A to § 3285.306 Typical Footing and Pier Design, Single Concrete Block.

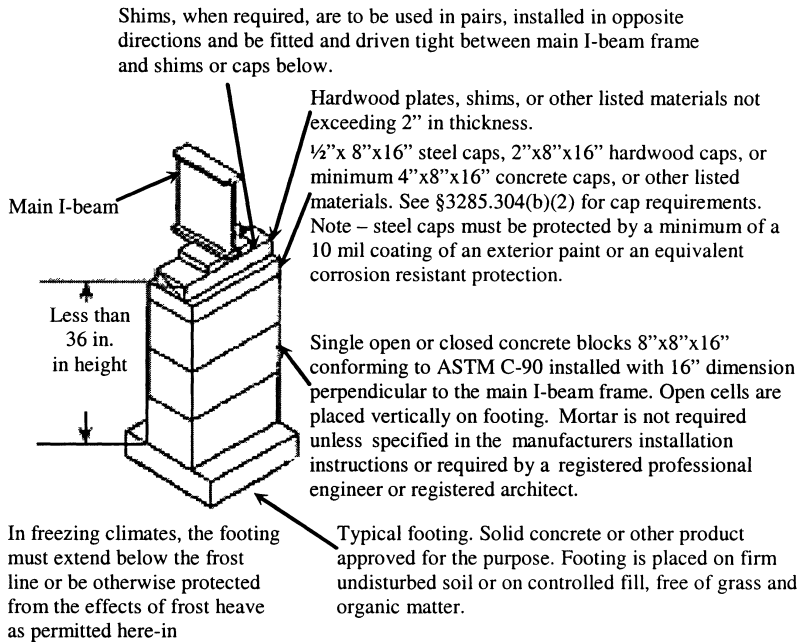
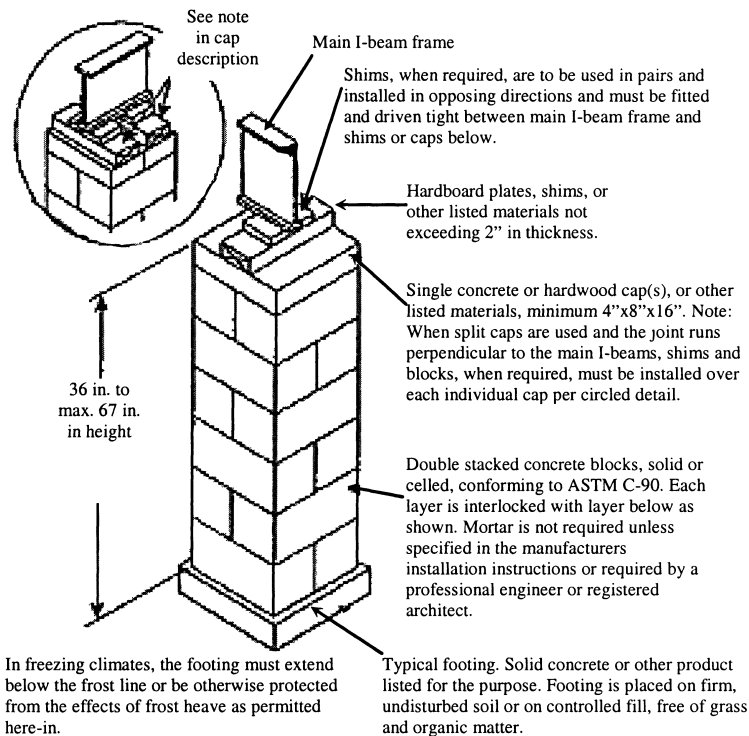

Figure B to 3285.306(b) Typical Footing and Pier Installation, Double Concrete Block.

**§ 3285.307 Perimeter support piers.**

(a) Piers required at mate-line supports, perimeter piers, and piers at exterior wall openings are permitted to be constructed of single open-cell or closed-cell concrete blocks, with nominal dimensions of 8 inches × 8 inches × 16 inches, to a maximum height of 54 inches, as shown in Figure A to this section, when the design capacity of the block is not exceeded.

(b) Piers used for perimeter support must be installed with the long dimension parallel to the perimeter rail.

§ 3285.308 Manufactured piers.

(a) Manufactured piers must be listed and labeled and installed to the pier manufacturer's installation instruc-

tions. See § 3285.303(d)(2) for additional requirements.

(b) Metal or other manufactured piers must be provided with protection against weather deterioration and corrosion at least equivalent to that provided by a coating of zinc on steel of .30 oz./ft.² of surface coated.

§ 3285.309 [Reserved]**§ 3285.310 Pier location and spacing.**

(a) The location and spacing of piers depends upon the dimensions of the home, the live and dead loads, the type of construction (single- or multi-section), I-beam size, soil bearing capacity, footing size, and such other factors as the location of doors or other openings.

§ 3285.310

24 CFR Ch. XX (4-1-11 Edition)

(b) Mate-line and column pier supports must be in accordance with this subpart and consistent with Figures A through C to this section, unless the pier support and footing configuration is designed by a registered professional engineer or registered architect.

(c) Piers supporting the frame must be no more than 24 inches from both

ends and not more than 120 inches center to center under the main rails.

(d) *Pier support locations.* Pier support locations and spacing must be presented to be consistent with Figures A and B to § 3285.312, as applicable, unless alternative designs are provided by a professional engineer or registered architect in accordance with acceptable engineering practice.

Figure A to § 3285.310 Typical Mate-Line Column Pier and Mating Wall Support when Frame Only Blocking is Required.

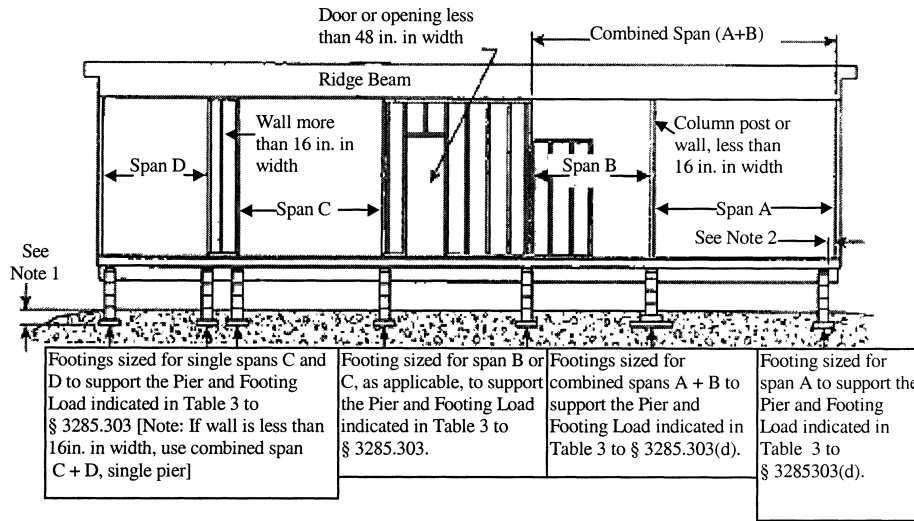

NOTES:

1. Bottom of footings must extend below frost line depth, unless designed for placement above the frost line. (See § 3285.312(b)).
2. Piers may be offset up to 6 in. in either direction along the supported members to allow for plumbing, electrical, mechanical, equipment, crawlspaces, or other devices.
3. Single-stack concrete block pier loads must not exceed 8,000 lbs.
4. Prefabricated piers must not exceed their approved or listed maximum vertical or horizontal design loads.

5. When a full-height mating wall does not support the ridge beam, this area is considered an unsupported span—Span B.
6. Piers are not required at openings in the mating wall that are less than 48 inches in width. Place piers on both sides of mating wall openings that are 48 inches or greater in width. For roof loads of 40 psf or greater, a professional engineer or registered architect must determine the maximum mating wall opening permitted without pier or other supports.

Figure B to § 3285.310(b) Typical Mate-Line Column Pier and Mating Wall Support When Perimeter Blocking is Required.

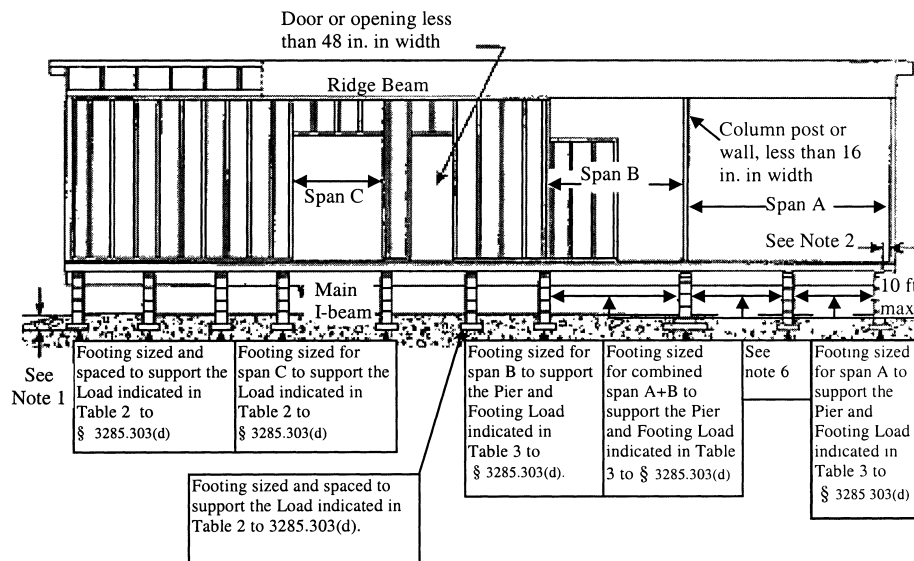

NOTES:

1. Bottom of footings must be below the frost line depth, unless designed for placement above the frost line. (See §3285.312(b)).
2. Piers may be offset 6 in. in either direction along supported members to allow for plumbing electrical, mechanical equipment, crawlspaces, or other devices.
3. Single stack concrete block pier loads must not exceed 8,000 lbs.
4. Piers are not required at openings in the mating wall that are less than 48 inches in width. Place piers on both sides of mating wall openings that are 48 inches or greater in width. For roof loads of 40 psf or greater, a

professional engineer or registered architect must determine the maximum mating wall opening permitted without pier or other supports.

5. When a full-height mating wall does not support the ridge beam, this area is considered an unsupported span—Span B.
6. In areas where the open span is greater than 10 ft., intermediate piers and footings must be placed at maximum 10 ft. on center.
7. Prefabricated piers must not exceed their approved or listed maximum horizontal or vertical design loads.
8. Column piers are in addition to piers required under full-height mating walls.

Figure C to § 3285.310 Typical Mate-Line Column and Piers.

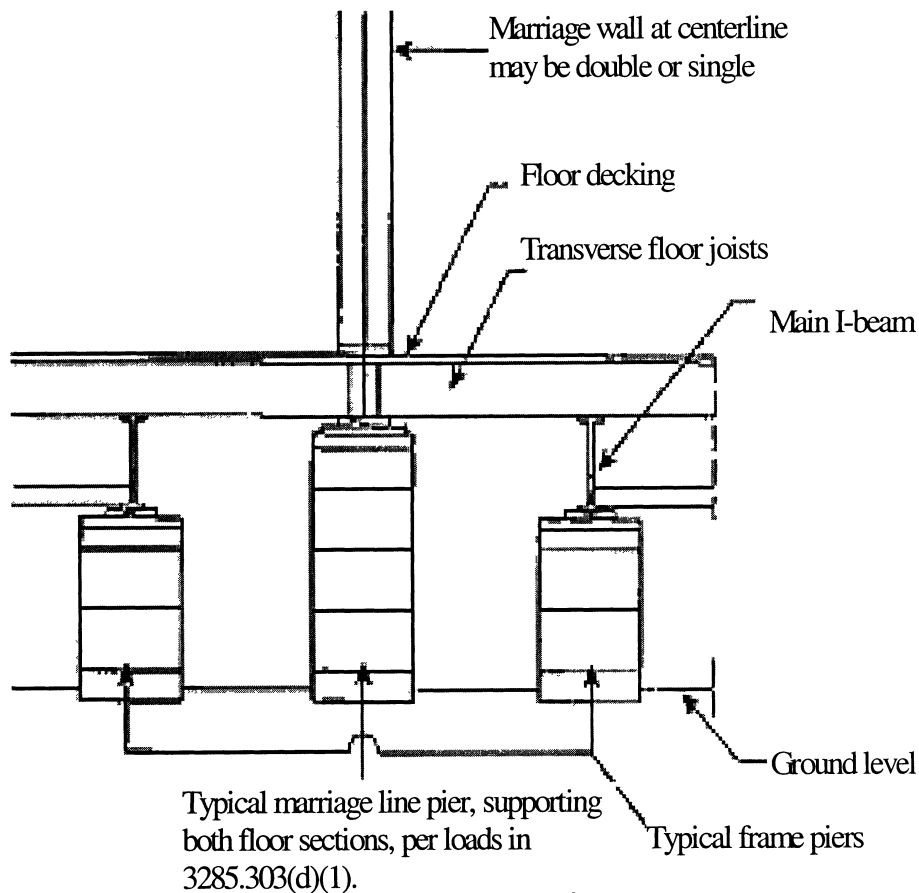

NOTES:

1. Mate-line column support piers are installed with the long dimension of the concrete block perpendicular to the rim joists.

2. Pier and footing designed to support both floor sections. Loads as listed in Table 3 to §3285.303 are total column loads for both sections.

§3285.311 Required perimeter supports.

(a) Perimeter pier or other supports must be located as follows:

(1) On both sides of side wall exterior doors (such as entry, patio, and sliding glass doors) and any other side wall

openings of 48 inches or greater in width, and under load-bearing porch posts, factory installed fireplaces, and fireplace stoves).

(2) Other perimeter supports must be:

(i) Located in accordance with Table 2 to §3285.303; or

(ii) Provided by other means such as additional outriggers or floor joists. When this alternative is used, the designs required by §3285.301 must consider the additional loads in sizing the pier and footing supports under the main chassis beam.

(b) For roof live loads of 40 psf or greater, a professional engineer or architect must determine the maximum sidewall opening permitted without perimeter pier or other supports.

(c) The location and installation of any perimeter pier support must not take the home out of compliance with the Manufactured Home Construction and Safety Standards (part 3280 of this chapter).

§ 3285.312 Footings.

(a) Materials approved for footings must provide equal load-bearing capacity and resistance to decay, as required by this section. Footings must be placed on undisturbed soil or fill compacted to 90 percent of maximum relative density. A footing must support every pier. Footings are to be either:

(1) *Concrete.*

(i) Four inch nominal precast concrete pads meeting or exceeding ASTM C 90-02a, Standard Specification for Loadbearing Concrete Masonry Units (incorporated by reference, see § 3285.4), without reinforcement, with at least a 28-day compressive strength of 1,200 pounds per square inch (psi); or

(ii) Six inch minimum poured-in-place concrete pads, slabs, or ribbons with at least a 28-day compressive strength of 3,000 pounds per square inch (psi). Site-specific soil conditions or design load requirements may also require the use of reinforcing steel in cast-in-place concrete footings.

(2) *Pressure-treated wood.*

(i) Pressure-treated wood footings must consist of a minimum of two layers of nominal 2-inch thick pressure-treated wood, a single layer of nominal ¾-inch thick, pressure-treated plywood with a maximum size of 16 inches by 16 inches, or at least two layers of ¾-inch thick, pressure-treated plywood for sizes greater than 16 inches by 16 inches. Plywood used for this purpose is to be rated exposure 1 or exterior sheathing, in accordance with PS1-95, Construction and Industrial Plywood (incorporated by reference, see § 3285.4).

(ii) Pressure treated lumber is to be treated with a water-borne adhesive, in accordance with AWWA Standard U1-04 (incorporated by reference, see § 3285.4) for Use Category 4B ground contact applications.

(iii) Cut ends of pressure treated lumber must be field-treated, in accordance with AWWA Standard M4-02 (incorporated by reference, see § 3285.4).

(3) *ABS footing pads.*

(i) ABS footing pads are permitted, provided they are installed in accordance with the pad manufacturer installation instructions and certified for use in the soil classification at the site.

(ii) ABS footing pads must be listed or labeled for the required load capacity.

(4) Other Materials. Footings may be of other materials than those identified in this section, provided they are listed for such use and meet all other applicable requirements of this subpart.

(b) *Placement in freezing climates.* Footings placed in freezing climates must be designed using methods and practices that prevent the effects of frost heave by one of the following methods:

(1) Conventional footings. Conventional footings must be placed below the frost line depth for the site unless an insulated foundation or monolithic slab is used (refer to §§ 3285.312(b)(2) and 3285.312(b)(3)). When the frost line depth is not available from the LAHJ, a registered professional engineer, registered architect, or registered geologist must be consulted to determine the required frost line depth for the manufactured home site. This is not subject to the provisions in § 3285.2(c) that also require review by the manufacturer and approval by its DAPIA for any variations to the manufacturer's installation instructions for support and anchoring.

(2) *Monolithic slab systems.* A monolithic slab is permitted above the frost line when all relevant site-specific conditions, including soil characteristics, site preparation, ventilation, and insulative properties of the under floor enclosure, are considered and anchorage requirements are accommodated as set out in § 3285.401. The monolithic slab system must be designed by a registered professional engineer or registered architect:

(i) In accordance with acceptable engineering practice to prevent the effects of frost heave; or

§ 3285.312

24 CFR Ch. XX (4-1-11 Edition)

(ii) In accordance with SEI/ASCE 32-01 (incorporated by reference, see § 3285.4).

(3) *Insulated foundations.* An insulated foundation is permitted above the frost line, when all relevant site-specific conditions, including soil characteristics, site preparation, ventilation, and insulative properties of the under floor enclosure, are considered, and the foundation is designed by a registered professional engineer or registered architect:

(i) In accordance with acceptable engineering practice to prevent the effects of frost heave; or

(ii) In accordance with SEI/ASCE 32-01 (incorporated by reference, see § 3285.4).

(c) *Sizing of footings.* The sizing and layout of footings depends on the load-bearing capacity of the soil, footings, and the piers. See §§ 3285.202 and 3285.303, and Table to 3285.312.

Figure A to § 3285.312 Typical Blocking Diagram for Single Section Homes

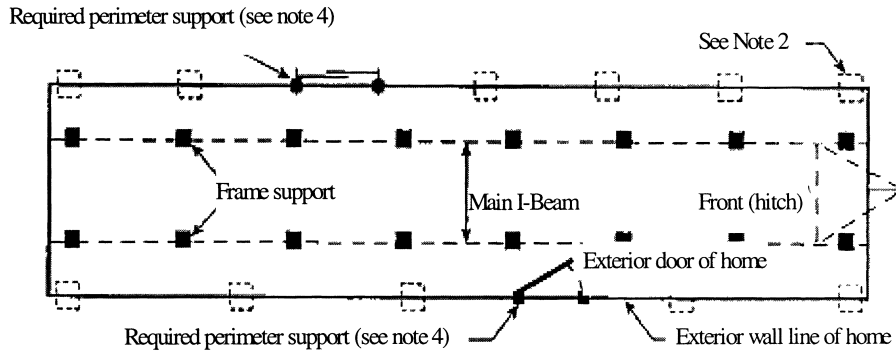

NOTES:

1. Refer to Table 1 of § 3285.303 for pier and footing requirements when frame blocking only is used.

2. In addition to blocking required by § 3285.311, see Table 2 to § 3285.303 for maximum perimeter blocking loads.

3. End piers under main I-beams may be set back a maximum of 24 inches, as measured from the outside edge of the floor to the center of the pier.

4. Place piers on both sides of sidewall exterior doors, patio doors, and sliding glass

doors; under porch posts, factory-installed fireplaces, and fireplace stoves; under jamb studs at multiple window openings; and at any other sidewall openings 48 inches or greater in width. For roof loads of 40 psf or greater, a professional engineer or registered architect must determine the maximum sidewall opening permitted without perimeter supports. See §§ 3285.307 and 3285.311 for additional requirements and for locating perimeter supports.

Figure B to § 3285.312 Typical Blocking Diagram for Multi-section Home.

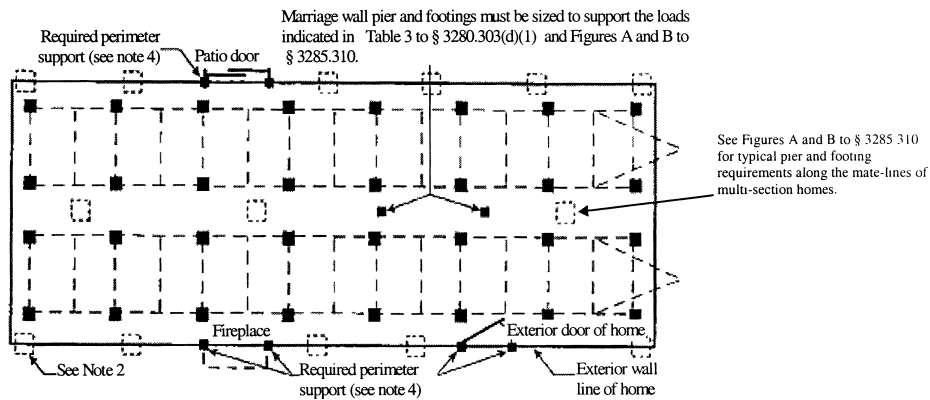

NOTES:

1. Refer to Table 1 to § 3285.303 for pier and footing requirements when frame blocking only is used.
2. In addition to blocking required by § 3285.311, see Tables 2 and 3 to § 3285.303 for maximum perimeter blocking loads.
3. End piers under main I-beams may be set back a maximum of 24 inches, as measured from the outside edge of the floor to the center of the pier.
4. Place piers on both sides of sidewall exterior doors, patio doors, and sliding glass doors; under porch posts, factory-installed fireplaces, and fireplace stoves; under jamb studs at multiple window openings; and at

any other sidewall openings of 48 inches or greater in width. For roof loads of 40 psf or greater, a professional engineer or registered architect must determine the maximum side wall opening permitted without perimeter supports or mating wall opening permitted without pier or other supports. See §§ 3285.307 and 3285.311 for additional information on requirements and for locating perimeter supports.

5. When an end pier under the mate-line also serves as a column pier, it may be set back a maximum of 6 in., as measured from the inside edge of the exterior wall to the center of the pier.

TABLE TO § 3285.312—THE SIZE AND CAPACITY FOR UNREINFORCED CAST-IN-PLACE FOOTINGS

Soil capacity (psf)	Minimum footing size (in.)	8 in. x 16 in. pier		16 in. x 16 in. pier	
		Maximum footing capacity (lbs.)	Unreinforced cast-in-place minimum thickness (in.)	Maximum footing capacity (lbs.)	Unreinforced cast-in-place minimum thickness (in.)
1,000	16 x 16	1,600	6	1,600	6
	20 x 20	2,600	6	2,600	6
	24 x 24	3,700	6	3,700	6
	30 x 30	5,600	8	5,800	6
	36 x 36	7,900	10	8,100	8
	42 x 42	⁴ 10,700	10	10,700	10
1,500	48 x 48	⁴ 13,100	12	13,600	10
	16 x 16	2,500	6	2,500	6
	20 x 20	4,000	6	4,000	6
	24 x 24	5,600	8	5,700	6
2,000	30 x 30	48,500	10	8,900	8
	36 x 36	⁴ 12,400	10	12,600	8
	42 x 42	⁴ 16,500	12	⁴ 16,800	10
	48 x 48	⁴ 21,200	14	⁴ 21,600	12
	16 x 16	3,400	6	3,400	6
	20 x 20	5,300	6	5,300	6
	24 x 24	7,600	8	7,700	6
	30 x 30	⁴ 11,700	10	11,900	8
	36 x 36	⁴ 16,700	15	⁴ 16,900	10

§ 3285.313

24 CFR Ch. XX (4–1–11 Edition)

TABLE TO § 3285.312—THE SIZE AND CAPACITY FOR UNREINFORCED CAST-IN-PLACE FOOTINGS—
Continued

Soil capacity (psf)	Minimum footing size (in.)	8 in. x 16 in. pier		16 in. x 16 in. pier	
		Maximum footing capacity (lbs.)	Unreinforced cast-in-place minimum thickness (in.)	Maximum footing capacity (lbs.)	Unreinforced cast-in-place minimum thickness (in.)
2,500	42 x 42	⁴ 21,700	18	⁴ 22,700	12
	16 x 16	4,300	6	4,300	6
	20 x 20	6,700	6	6,700	6
	24 x 24	⁴ 9,600	8	9,700	6
	30 x 30	⁴ 14,800	10	15,000	8
3,000	36 x 36	⁴ 20,700	12	⁴ 21,400	10
	16 x 16	5,200	6	5,200	6
	20 x 20	8,100	8	8,100	6
	24 x 24	⁴ 11,500	10	11,700	6
	30 x 30	⁴ 17,800	12	⁴ 18,100	8
4,000	36 x 36	⁴ 25,400	14	⁴ 25,900	10
	16 x 16	7,000	6	7,000	6
	20 x 20	⁴ 10,800	8	10,900	6
	24 x 24	⁴ 15,500	10	15,600	8
	30 x 30	⁴ 23,300	12	⁴ 24,200	10

NOTES:

1. The footing sizes shown are for square pads and are based on the area (in.²), shear and bending required for the loads shown. Other configurations, such as rectangular or circular configurations, can be used, provided the area and depth is equal to or greater than the area and depth of the square footing shown in the table, and the distance from the edge of the pier to the edge of the footing is not less than the thickness of the footing.

2. The 6 in. cast-in-place values can be used for 4 in. unreinforced precast concrete footings.

3. The capacity values listed have been reduced by the dead load of the concrete footing.

4. Concrete block piers must not exceed their design capacity of 8,000 lbs. for 8" x 16" single stack block and 16,000 lbs. for 16" x 16" double stack block.

5. A registered professional engineer or registered architect must prepare the design, if the design loads exceed the capacity for single or double stack concrete block piers shown in footnote 4.

§ 3285.313 **Combination systems.**

Support systems that combine both load-bearing capacity and uplift resistance must also be sized and designed for all applicable design loads.

§ 3285.314 [Reserved]

§ 3285.315 **Special snow load conditions.**

(a) *General.* Foundations for homes designed for and located in areas with

roof live loads greater than 40 psf must be designed by the manufacturer for the special snow load conditions, in accordance with acceptable engineering practice. Where site or other conditions prohibit the use of the manufacturer's instructions, a registered professional engineer or registered architect must design the foundation for the special snow load conditions.

(b) *Ramadas.* Ramadas may be used in areas with roof live loads greater than 40 psf. Ramadas are to be self-supporting, except that any connection to the home must be for weatherproofing only.

Subpart E—Anchorage Against Wind

§ 3285.401 **Anchoring instructions.**

(a) After blocking and leveling, the manufactured home must be secured against the wind by use of anchor assembly type installations or by connecting the home to an alternative foundation system. See § 3285.301.

(b) For anchor assembly type installations, the installation instructions must require the home to be secured against the wind, as described in this section. The installation instructions and design for anchor type assemblies

must be prepared by a registered professional engineer or registered architect, in accordance with acceptable engineering practice, the design loads of the MHCSS, and § 3285.301(d).

(c) All anchoring and foundation systems must be capable of meeting the loads that the home was designed to withstand required by part 3280, subpart D of this chapter, as shown on the home's data plate. Exception: Manufactured homes that are installed in less restrictive roof load zone and wind zone areas may have foundation or anchorage systems that are capable of meeting the lower design load provisions of the Standards, if the design for the lower requirements is either provided in the installation instructions or the foundation and anchorage system is designed by a professional engineer or registered architect.

(d) The installation instructions are to include at least the following information and details for anchor assembly-type installations:

(1) The maximum spacing for installing diagonal ties and any required vertical ties or straps to ground anchors;

(2) The minimum and maximum angles or dimensions for installing diagonal ties or straps to ground anchors and the main chassis members of the manufactured home;

(3) Requirements for connecting the diagonal ties to the main chassis members of the manufactured home. If the diagonal ties are attached to the bottom flange of the main chassis beam, the frame must be designed to prevent rotation of the beam;

(4) Requirements for longitudinal and mating wall tie-downs and anchorage;

(5) The method of strap attachment to the main chassis member and ground anchor, including provisions for swivel-type connections;

(6) The methods for protecting vertical and diagonal strapping at sharp corners by use of radius clips or other means; and

(7) As applicable, the requirements for sizing and installation of stabilizer plates.

§ 3285.402 Ground anchor installations.

(a) *Ground anchor certification and testing.* Each ground anchor must be manufactured and provided with installation instructions, in accordance with its listing or certification. A nationally recognized testing agency must list, or a registered professional engineer or registered architect must certify, the ground anchor for use in a classified soil (refer to § 3285.202), based on a nationally recognized testing protocol, or a professional engineer or registered architect must certify that the ground anchor is capable of resisting all loads in paragraph (b) of this section for the soil type or classification.

(b) *Specifications for tie-down straps and ground anchors—(1) Ground anchors.* Ground anchors must be installed in accordance with their listing or certification, be installed to their full depth, be provided with protection against weather deterioration and corrosion at least equivalent to that provided by a coating of zinc on steel of not less than 0.30 oz./ft.² of surface coated, and be capable of resisting a minimum ultimate load of 4,725 lbs. and a working load of 3,150 lbs., as installed, unless reduced capacities are noted in accordance with note 11 of Table 1 to this section or note 12 of Tables 2 and 3 to this section. The ultimate load and working load of ground anchors and anchoring equipment must be determined by a registered professional engineer, registered architect, or tested by a nationally recognized third-party testing agency in accordance with a nationally recognized testing protocol.

(2) *Tie-down straps.* A 1¼ inch x 0.035 inch or larger steel strapping conforming to ASTM D 3953—97, Standard Specification for Strapping, Flat Steel and Seals (incorporated by reference, see § 3285.4), Type 1, Grade 1, Finish B, with a minimum total capacity of 4,725 pounds (lbs.) and a working capacity of 3,150 pounds (lbs.) must be used. The tie-down straps must be provided with protection against weather deterioration and corrosion at least equivalent to that provided by a coating of zinc on steel of not less than 0.30 oz./ft.² of surface coated. Slit or cut edges of coated strapping need not be zinc coated.

§ 3285.402

24 CFR Ch. XX (4-1-11 Edition)

(c) *Number and location of ground anchors.* (1) Ground anchor and anchor strap spacing must be:

(i) No greater than the spacing shown in Tables 1 through 3 to this section and Figures A and B to this section; or

(ii) Designed by a registered engineer or architect, in accordance with acceptable engineering practice and the requirements of the MHCSS for any conditions that are outside the parameters and applicability of the Tables 1 through 3 to this section.

(2) The requirements in paragraph (c) of this section must be used to determine the maximum spacing of ground anchors and their accompanying anchor straps, based on the soil classification determined in accordance with §3285.202:

(i) The installed ground anchor type and size (length) must be listed for use in the soil class at the site and for the minimum and maximum angle permitted between the diagonal strap and the ground; and

(ii) All ground anchors must be installed in accordance with their listing or certification and the ground anchor manufacturer installation instructions; and

(iii) If required by the ground anchor listing or certification, the correct size and type of stabilizer plate is installed. If metal stabilizer plates are used, they must be provided with protection against weather deterioration and corrosion at least equivalent to that provided by a coating of zinc on steel of not less than 0.30 oz./ft.² of surface coated. Alternatively, ABS stabilizer plates may be used when listed and certified for such use.

(3) *Longitudinal anchoring.* Manufactured homes must also be stabilized against wind in the longitudinal direction in all Wind Zones. Manufactured homes located in Wind Zones II and III must have longitudinal ground anchors installed on the ends of the manufactured home transportable section(s) or be provided with alternative systems that are capable of resisting wind forces in the longitudinal direction. See Figure C to §3285.402 for an example of one method that may be used to provide longitudinal anchoring. A professional engineer or registered architect must certify the longitudinal anchoring method or any alternative system used as adequate to provide the required stabilization, in accordance with acceptable engineering practice.

Figure A to § 3285.402 Ground Anchor Locations and Spacing – Plan View.

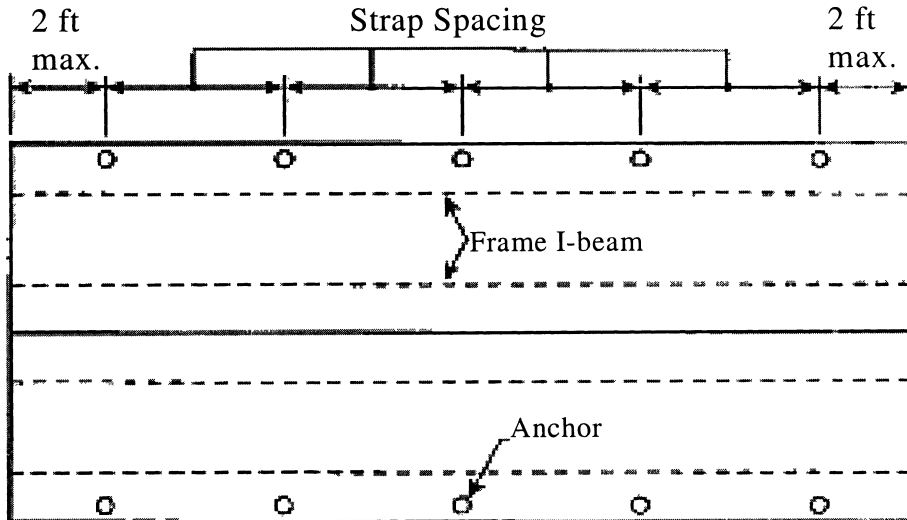

- NOTES:
1. Refer to Tables 1, 2, and 3 to this section for maximum ground anchor spacing.
 2. Longitudinal anchors not shown for clarity; refer to 3285.402(b)(2) for longitudinal anchoring requirements.

Figure B to § 3285.402 Anchor Strap and Pier Relationship.

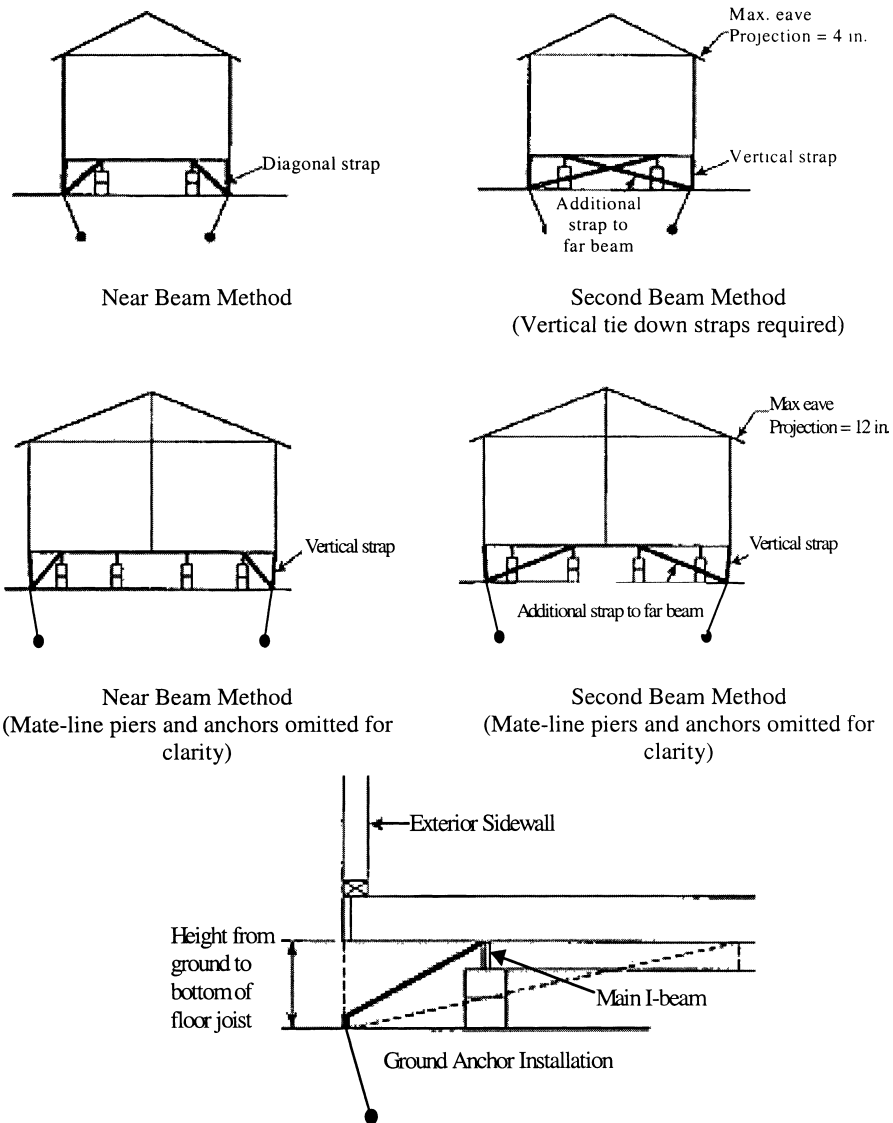

- NOTES:
1. Vertical Straps are not required in Wind Zone I.
 2. The frame must be designed to prevent rotation of the main chassis beam, when the

§ 3285.402

24 CFR Ch. XX (4-1-11 Edition)

diagonal ties are not attached to the top flange of the beam. See § 3285.401(d)(3).

Figure C to § 3285.402 Longitudinal Anchoring

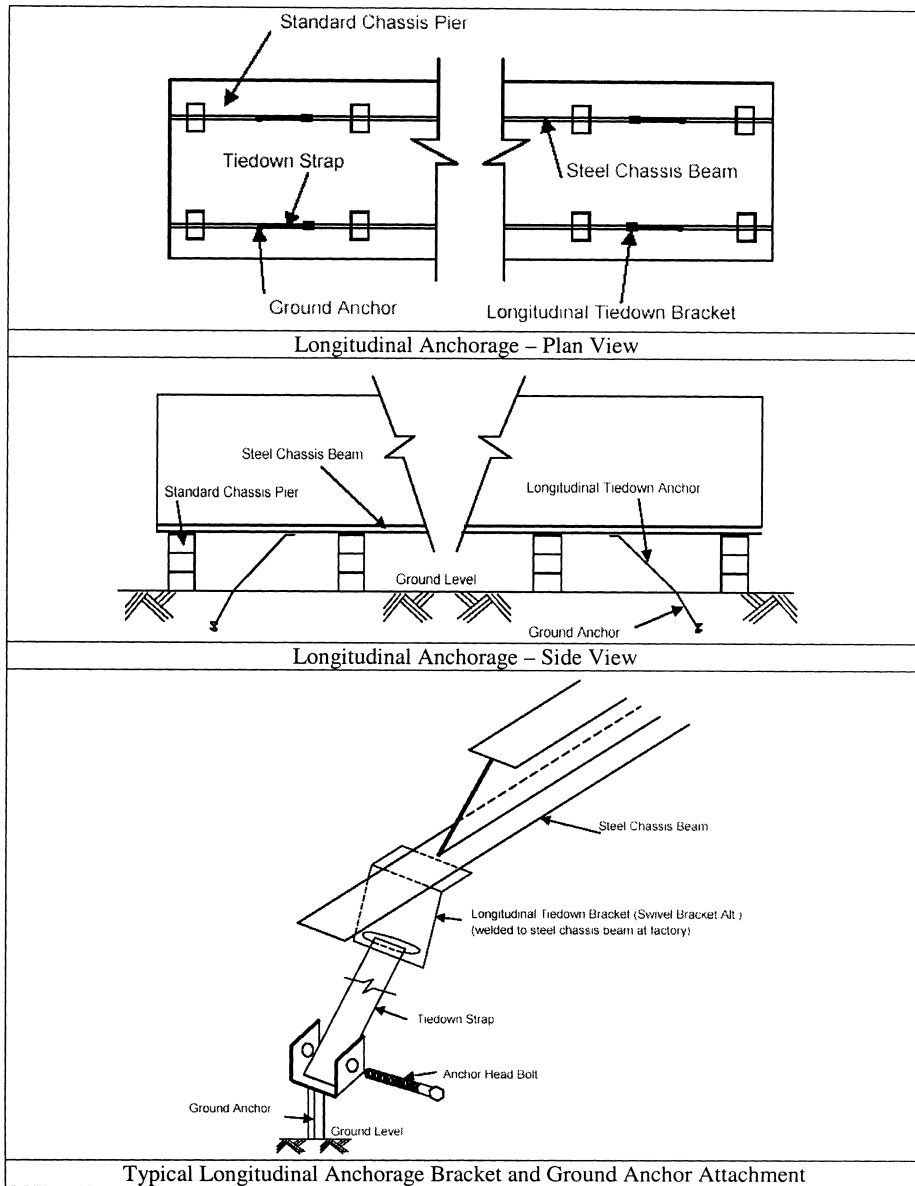

TABLE 1 TO § 3285.402—MAXIMUM DIAGONAL TIE-DOWN STRAP SPACING, WIND ZONE I

Nominal floor width, single section/multi-section	Max. height from ground to diagonal strap attachment	I-beam spacing	
		82.5 in.	99.5 in.
12/24 ft. 144 in. nominal section(s)	25 in	14 ft. 2 in	N/A
	33 in	11 ft. 9 in	N/A
	46 in	9 ft. 1 in	N/A
	67 in	N/A	N/A
14/28 ft. 168 in. nominal section(s)	25 in	18 ft. 2 in	15 ft. 11 in.
	33 in	16 ft. 1 in	13 ft. 6 in.
	46 in	13 ft. 3 in	10 ft. 8 in.
	67 in	10 ft. 0 in	N/A
16/32 ft. 180 in. to 192 in. nominal section(s)	25 in	N/A	19 ft. 5 in.
	33 in	19 ft. 0 in	17 ft. 5 in.
	46 in	16 ft. 5 in	14 ft. 7 in.
	67 in	13 ft. 1 in	11 ft. 3 in.

NOTES:

1. Table is based on maximum 90 in. side-wall height.
2. Table is based on maximum 4 in. inset for ground anchor head from edge of floor or wall.
3. Table is based on main rail (I-beam) spacing per given column.
4. Table is based on maximum 4 in. eave width for single-section homes and maximum 12 in. for multi-section homes.
5. Table is based on maximum 20-degree roof pitch (4.3/12).
6. Table is based upon the minimum height between the ground and the bottom of the floor joist being 18 inches. Interpolation may be required for other heights from ground to strap attachment.
7. Additional tie-downs may be required per the home manufacturer instructions.
8. Ground anchors must be certified for these conditions by a professional engineer, architect, or listed by a nationally recognized testing laboratory.
9. Ground anchors must be installed to their full depth, and stabilizer plates, if required by the ground anchor listing or certification, must also be installed in accordance with the listing or certification and in

accordance with the ground anchor and home manufacturer instructions.

10. Strapping and anchoring equipment must be certified by a registered professional engineer or registered architect, or listed by a nationally recognized testing agency to resist these specified forces, in accordance with testing procedures in ASTM D 3953-97, Standard Specification for Strapping, Flat Steel and Seals (incorporated by reference, see § 3285.4).

11. A reduced ground anchor or strap working load capacity will require reduced tie-down strap and anchor spacing.

12. Ground anchors must not be spaced closer than the minimum spacing permitted by the listing or certification.

13. Table is based on a 3,150 lbs. working load capacity, and straps must be placed within 2 ft. of the ends of the home.

14. Table is based on a minimum angle of 30 degrees and a maximum angle of 60 degrees between the diagonal strap and the ground.

15. Table does not consider flood or seismic loads and is not intended for use in flood or seismic hazard areas. In those areas, the anchorage system is to be designed by a professional engineer or architect.

TABLE 2 TO § 3285.402—MAXIMUM DIAGONAL TIE-DOWN STRAP SPACING, WIND ZONE II.

Nominal floor width, single section/multi-section	Max. height from ground to diagonal strap attachment	Near beam method I-beam spacing		Second beam method I-beam spacing	
		82.5 in.	99.5 in.	82.5 in.	99.5 in.
12 ft/24 ft. 144 in. nominal section(s).	25 in	6 ft. 2 in	4 ft. 3 in	N/A	N/A
	33 in	5 ft. 2 in	N/A	N/A	N/A
	46 in	4 ft. 0 in	N/A	N/A	N/A
	67 in	N/A	N/A	6 ft 1 in	6 ft 3 in
14 ft/28 ft. 168 in. nominal section(s).	25 in	7 ft. 7 in	6 ft. 9 in	N/A	N/A
	33 in	6 ft. 10 in	5 ft. 9 in	N/A	N/A
	46 in	5 ft. 7 in	4 ft. 6 in	N/A	N/A
	67 in	4 ft. 3 in	N/A	N/A	N/A

TABLE 2 TO § 3285.402—MAXIMUM DIAGONAL TIE-DOWN STRAP SPACING, WIND ZONE II.—
Continued

Nominal floor width, single section/multi-section	Max. height from ground to diagonal strap attachment	Near beam method I-beam spacing		Second beam method I-beam spacing	
		82.5 in.	99.5 in.	82.5 in.	99.5 in.
16 ft/32 ft. 180 in. to 192 in. nominal section(s).	25 in	N/A	7 ft. 10 in	N/A	N/A
	33 in	7 ft. 6 in	7 ft. 2 in	N/A	N/A
	46 in	6 ft. 9 in	6 ft. 0 in	N/A	N/A
	67 in	5 ft. 4 in	4 ft. 7 in	N/A	N/A

NOTES:

1. Table is based on maximum 90 in. side-wall height.
2. Table is based on maximum 4 in. inset for ground anchor head from edge of floor or wall.
3. Tables are based on main rail (I-beam) spacing per given column.
4. Table is based on maximum 4 in. eave width for single-section homes and maximum 12 in. for multi-section homes.
5. Table is based on maximum 20-degree roof pitch (4.3/12).
6. All manufactured homes designed to be located in Wind Zone II must have a vertical tie installed at each diagonal tie location.
7. Table is based upon the minimum height between the ground and the bottom of the floor joist being 18 inches. Interpolation may be required for other heights from ground to strap attachment.
8. Additional tie downs may be required per the home manufacturer instructions.
9. Ground anchors must be certified by a professional engineer, or registered architect, or listed by a nationally recognized testing laboratory.
10. Ground anchors must be installed to their full depth, and stabilizer plates, if required by the ground anchor listing or cer-

tification, must also be installed in accordance with the listing or certification and in accordance with the ground anchor and home manufacturer instructions.

11. Strapping and anchoring equipment must be certified by a registered professional engineer or registered architect or must be listed by a nationally recognized testing agency to resist these specified forces, in accordance with testing procedures in ASTM D 3953-97, Standard Specification for Strapping, Flat Steel and Seals (incorporated by reference, see § 3285.4).

12. A reduced ground anchor or strap working load capacity will require reduced tie-down strap and anchor spacing.

13. Ground anchors must not be spaced closer than the minimum spacing permitted by the listing or certification.

14. Table is based on a 3,150 lbs. working load capacity, and straps must be placed within 2 ft. of the ends of the home.

15. Table is based on a minimum angle of 30 degrees and a maximum of 60 degrees between the diagonal strap and the ground.

16. Table does not consider flood or seismic loads and is not intended for use in flood or seismic hazard areas. In those areas, the anchorage system is to be designed by a professional engineer or architect.

TABLE 3 TO § 3285.402—MAXIMUM DIAGONAL TIE-DOWN STRAP SPACING, WIND ZONE III.

Nominal floor width, single section/multi-section	Max. height from ground to diagonal strap attachment	Near beam method I-beam spacing		Second beam method I-beam spacing	
		82.5 in.	99.5 in.	82.5 in.	99.5 in.
12 ft./24 ft. 144 in. nominal section(s).	25 in	5 ft. 1 in	N/A	N/A	N/A
	33 in	4 ft. 3 in	N/A	N/A	N/A
	46 in	N/A	N/A	N/A	N/A
14 ft./28 ft. 168 in. nominal section(s).	67 in	N/A	N/A	N/A	N/A
	25 in	6 ft. 2 in.	5 ft. 7 in	N/A	N/A
	33 in	5 ft. 8 in	4 ft. 9 in	N/A	N/A
16 ft./32 ft. 180 in. to 192 in. nominal sections.	46 in	4 ft. 8 in	N/A	N/A	N/A
	67 in	N/A	N/A	N/A	N/A
	25 in	N/A	6 ft. 3 in	N/A	N/A
	33 in	6 ft. 1 in	5 ft. 11 in	N/A	N/A
	46 in	5 ft. 7 in	5 ft. 0 in	N/A	N/A
	67 in	4 ft. 5 in	N/A	N/A	N/A

NOTES: 1. Table is based on maximum 90 in. sidewall height.

2. Table is based on maximum 4 in. inset for ground anchor head from edge of floor or wall.

3. Table is based on main rail (I-beam) spacing per given column.

4. Table is based on maximum 4 in. eave width for single-section homes and maximum 12 in. for multi-section homes.

5. Table is based on maximum 20-degree roof pitch (4.3/12).

6. All manufactured homes designed to be located in Wind Zone III must have a vertical tie installed at each diagonal tie location.

7. Table is based upon the minimum height between the ground and the bottom of the floor joist being 18 inches. Interpolation may be required for other heights from ground to strap attachment.

8. Additional tie downs may be required per the home manufacturer instructions.

9. Ground anchors must be certified by a professional engineer, or registered architect, or listed by a nationally recognized testing laboratory.

10. Ground anchors must be installed to their full depth, and stabilizer plates, if required by the ground anchor listing or certification, must also be installed in accordance with the listing or certification and per the ground anchor and home manufacturer instructions.

11. Strapping and anchoring equipment must be certified by a registered professional engineer or registered architect or must be listed by a nationally recognized testing agency to resist these specified forces, in accordance with testing procedures in ASTM D 3953-97, Standard Specification for Strapping, Flat Steel and Seals (incorporated by reference, see § 3285.4).

12. A reduced ground anchor or strap working load capacity will require reduced tie-down strap and anchor spacing.

13. Ground anchors must not be spaced closer than the minimum spacing permitted by the listing or certification.

14. Table is based on a 3,150 lbs. working load capacity, and straps must be placed within 2 ft. of the ends of the home.

15. Table is based on a minimum angle of 30 degrees and a maximum angle of 60 degrees between the diagonal strap and the ground.

16. Table does not consider flood or seismic loads and is not intended for use in flood or seismic hazard areas. In those areas, the anchorage system is to be designed by a professional engineer or architect.

§ 3285.403 Sidewall, over-the-roof, mate-line, and shear wall straps.

If sidewall, over-the-roof, mate-line, or shear wall straps are installed on

the home, they must be connected to an anchoring assembly.

§ 3285.404 Severe climatic conditions.

In frost-susceptible soil locations, ground anchor augers must be installed below the frost line, unless the foundation system is frost-protected to prevent the effects of frost heave, in accordance with acceptable engineering practice and § 3280.306 of this chapter and § 3285.312.

§ 3285.405 Severe wind zones.

When any part of a home is installed within 1,500 feet of a coastline in Wind Zones II or III, the manufactured home must be designed for the increased requirements, as specified on the home's data plate (refer to § 3280.5(f) of this chapter) in accordance with acceptable engineering practice. Where site or other conditions prohibit the use of the manufacturer's instructions, a registered professional engineer or registered architect, in accordance with acceptable engineering practice, must design anchorage for the special wind conditions.

§ 3285.406 Flood hazard areas.

Refer to § 3285.302 for anchoring requirements in flood hazard areas.

Subpart F—Optional Features

§ 3285.501 Home installation manual supplements.

Supplemental instructions for optional equipment or features must be approved by the DAPIA as not taking the home out of conformance with the requirements of this part, or part 3280 of this chapter, and included with the manufacturer installation instructions.

§ 3285.502 Expanding rooms.

The support and anchoring systems for expanding rooms must be installed in accordance with designs provided by the home manufacturer or prepared by a registered professional engineer or registered architect, in accordance with acceptable engineering practice.

§ 3285.503 Optional appliances.

(a) *Comfort cooling systems.* When not provided and installed by the home

manufacturer, any comfort cooling systems that are installed must be installed according to the appliance manufacturer's installation instructions.

(1) *Air conditioners.* Air conditioning equipment must be listed or certified by a nationally recognized testing agency for the application for which the unit is intended and installed in accordance with the terms of its listing or certification (see §3280.714 of this chapter).

(i) *Energy efficiency.* (A) Site-installed central air conditioning equipment must be sized to meet the home's heat gain requirement, in accordance with Chapter 28 of the 1997 ASHRAE Handbook of Fundamentals (incorporated by reference, see §3285.4) or ACCA Manual J, Residential Cooling Load, 8th Edition (incorporated by reference, see §3285.4). Information necessary to calculate the home's heat gain can be found on the home's comfort cooling certificate.

(B) The BTU/hr. rated capacity of the site-installed air conditioning equipment must not exceed the air distribution system's rated BTU/hr. capacity as shown on the home's compliance certificate.

(ii) *Circuit rating.* If a manufactured home is factory-provided with an exterior outlet to energize heating and/or air conditioning equipment, the branch circuit rating on the tag adjacent to this outlet must be equal to or greater than the minimum circuit amperage identified on the equipment rating plate.

(iii) *A-coil units.* (A) A-coil air conditioning units must be compatible and listed for use with the furnace in the home and installed in accordance with the appliance manufacturer's instructions.

(B) The air conditioner manufacturer instructions must be followed.

(C) All condensation must be directed beyond the perimeter of the home by means specified by the equipment manufacturer.

(2) *Heat pumps.* Heat pumps must be listed or certified by a nationally recognized testing agency for the application for which the unit is intended and installed in accordance with the terms of its listing or certification. (See §3280.714 of this chapter).

(3) *Evaporative coolers.* (i) A roof-mounted cooler must be listed or certified by a nationally recognized testing agency for the application for which the unit is intended and installed in accordance with the terms of its listing (see §3280.714 of this chapter).

(A) Any discharge grill must not be closer than three feet from a smoke alarm.

(B) Before installing a roof-mounted evaporative cooler on-site, the installer must ensure that the roof will support the weight of the cooler.

(C) A rigid base must be provided to distribute the cooler weight over multiple roof trusses to adequately support the weight of the evaporative cooler.

(ii) An evaporative cooler that is not roof-mounted is to be installed in accordance with the requirements of its listing or the equipment manufacturer's instructions, whichever is the more restrictive.

(b) *Fireplaces and wood-stoves.* When not provided by the home manufacturer, fireplaces and wood-stoves including chimneys and air inlets for fireplaces and wood stoves must be listed for use with manufactured homes and must be installed in accordance with their listings.

(c) *Appliance venting.* (1) All fuel burning heat producing appliances of the vented type except ranges and ovens must be vented to the exterior of the home.

(2) Upon completion, the venting system must comply with all requirements of §§3280.707(b) and 3280.710 of the Manufactured Home Construction and Safety Standards in this chapter.

(3) When the vent exhausts through the floor, the vent must not terminate under the home and must extend to the home's exterior and through any skirting that may be installed.

(d) *Clothes dryer exhaust duct system.* A clothes dryer exhaust duct system must conform with and be completed in accordance with the appliance manufacturer instructions and §3280.708 of this chapter. The vents must exhaust to the exterior of the home, beyond any perimeter skirting installed around it, as shown in Figure to §3285.503.

Figure A to § 3285.503 Dryer Exhaust System.

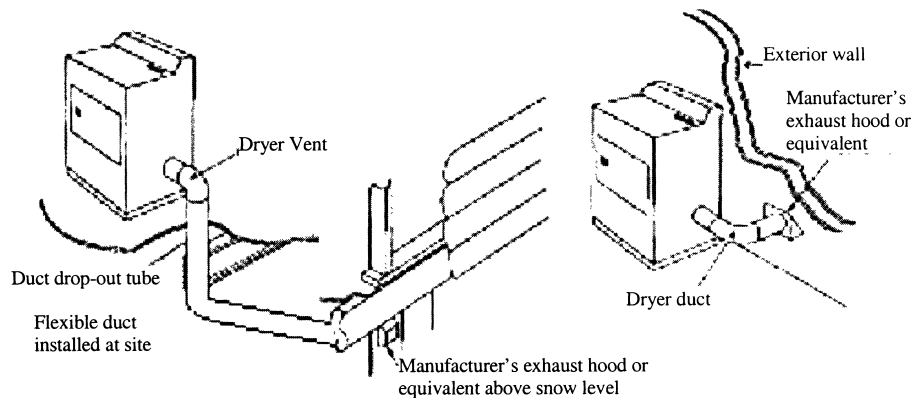

NOTES:

1. Installation of the exhaust system must be in accordance with the dryer manufacturer instructions.
2. Dryer exhaust system must not contain reverse slope or terminate under the home.

§ 3285.504 Skirting.

(a) Skirting, if used, must be of weather-resistant materials or provided with protection against weather deterioration at least equivalent to that provided by a coating of zinc on steel of not less than 0.30 oz./ft.² of surface coated.

(b) Skirting must not be attached in a manner that can cause water to be trapped between the siding and trim or forced up into the wall cavities trim to which it is attached.

(c) All wood skirting within 6 inches of the ground must be pressure-treated in accordance with AWP Standard U1 (incorporated by reference, see §3285.4) for Use Category 4A, Ground Anchor Contact Applications, or be naturally resistant to decay and termite infestations.

(d) Skirting must not be attached in a manner that impedes the contraction and expansion characteristics of the home's exterior covering.

§ 3285.505 Crawlspace ventilation.

(a) A crawlspace with skirting must be provided with ventilation openings. The minimum net area of ventilation

openings must not be less than one square foot (ft.²) for every 150 square feet (ft.²) of the home's floor area. The total area of ventilation openings may be reduced to one square foot (ft.²) for every 1,500 square feet (ft.²) of the home's floor area, where a uniform 6-mil polyethylene sheet material or other acceptable vapor retarder is installed, according to §3285.204, on the ground surface beneath the entire floor area of the home.

(b) Ventilation openings must be placed as high as practicable above the ground.

(c) Ventilation openings must be located on at least two opposite sides to provide cross-ventilation.

(d) Ventilation openings must be covered for their full height and width with a perforated corrosion and weather-resistant covering that is designed to prevent the entry of rodents. In areas subject to freezing, the coverings for the ventilation openings must also be of the adjustable type, permitting them to be in the open or closed position, depending on the climatic conditions.

(e) Access opening(s) not less than 18 inches in width and 24 inches in height and not less than three square feet (ft.²) in area must be provided and must be located so that any utility connections located under the home are accessible.

§ 3285.601

(f) Dryer vents and combustion air inlets must pass through the skirting to the outside. Any surface water runoff from the furnace, air conditioning, or water heater drains must be directed away from under the home or collected by other methods identified in § 3285.203.

Subpart G—Ductwork and Plumbing and Fuel Supply Systems

§ 3285.601 Field assembly.

Home manufacturers must provide specific installation instructions for the proper field assembly of manufacturer-supplied and shipped loose ducts, plumbing, and fuel supply system parts that are necessary to join all sections of the home and are designed to be located underneath the home. The installation instructions must be designed in accordance with applicable requirements of part 3280, subparts G and H, of this chapter, as specified in this subpart.

§ 3285.602 Utility connections.

Refer to § 3285.904 for considerations for utility system connections.

§ 3285.603 Water supply.

(a) *Crossover.* Multi-section homes with plumbing in both sections require water-line crossover connections to join all sections of the home. The crossover design requirements are located in, and must be designed in accordance with, § 3280.609 of this chapter.

(b) *Maximum supply pressure and reduction.* When the local water supply pressure exceeds 80 psi to the manufactured home, a pressure-reducing valve must be installed.

(c) *Mandatory shutoff valve.* (1) An identified and accessible shutoff valve must be installed between the water supply and the inlet.

(2) The water riser for the shutoff valve connection must be located underneath or adjacent to the home.

(3) The shutoff valve must be a full-flow gate or ball valve, or equivalent valve.

(d) *Freezing protection.* Water line crossovers completed during installation must be protected from freezing. The freeze protection design requirements are located in, and must be de-

24 CFR Ch. XX (4–1–11 Edition)

signed in accordance with, § 3280.603 of this chapter.

(1) If subject to freezing temperatures, the water connection must be wrapped with insulation or otherwise protected to prevent freezing.

(2) In areas subject to freezing or sub-freezing temperatures, exposed sections of water supply piping, shutoff valves, pressure reducers, and pipes in water heater compartments must be insulated or otherwise protected from freezing.

(3) *Use of pipe heating cable.* Only pipe heating cable listed for manufactured home use is permitted to be used, and it must be installed in accordance with the cable manufacturer installation instructions.

(e) *Testing procedures.* (1) The water system must be inspected and tested for leaks after completion at the site. The installation instructions must provide testing requirements that are consistent with § 3280.612 of this chapter.

(2) The water heater must be disconnected when using an air-only test.

§ 3285.604 Drainage system.

(a) *Crossovers.* Multi-section homes with plumbing in more than one section require drainage system crossover connections to join all sections of the home. The crossover design requirements are located in, and must be designed in accordance with, § 3280.610 of this chapter.

(b) *Assembly and support.* If portions of the drainage system were shipped loose because they were necessary to join all sections of the home and designed to be located underneath the home, they must be installed and supported in accordance with § 3280.608 of this chapter.

(c) *Proper slopes.* Drains must be completed in accordance with § 3280.610 of this chapter.

(1) Drain lines must not slope less than one-quarter inch per foot, unless otherwise noted on the schematic diagram, as shown in Figure to § 3285.604.

(2) A slope of one-eighth inch per foot may be permitted when a clean-out is installed at the upper end of the run.

(d) *Testing procedures.* The drainage system must be inspected and tested for leaks after completion at the site.

The installation instructions must provide testing requirements that are consistent with § 3280.612 of this chapter.

Figure A to § 3285.604 Drain Pipe Slope and Connections.

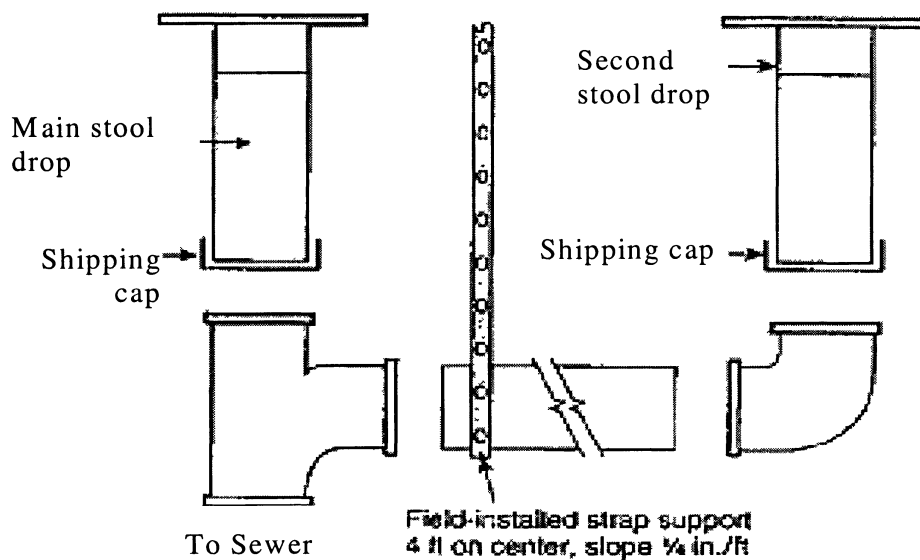

§ 3285.605 Fuel supply system.

(a) *Proper supply pressure.* The gas piping system in the home is designed for a pressure that is at least 7 inches of water column [4oz./in.² or 0.25 psi] and not more than 14 inches of water column [8 oz./in.² or 0.5 psi]. If gas from any supply source exceeds, or could exceed this pressure, a regulator must be installed if required by the LAHJ.

(b) *Crossovers.* (1) Multi-section homes with fuel supply piping in both sections require crossover connections to join all sections of the home. The crossover design requirements are located in, and must be designed in accordance with, § 3280.705 of this chapter.

(2) Tools must not be required to connect or remove the flexible connector quick-disconnect.

(c) *Testing procedures.* The gas system must be inspected and tested for leaks after completion at the site. The installation instructions must provide

testing requirements that are consistent with § 3280.705 of this chapter.

§ 3285.606 Ductwork connections.

(a) Multi-section homes with ductwork in more than one section require crossover connections to complete the duct system of the home. All ductwork connections, including duct collars, must be sealed to prevent air leakage. Galvanized metal straps or tape and mastics listed to UL 181A (incorporated by reference, see § 3285.4), for closure systems with rigid air ducts and connectors, or UL 181B (incorporated by reference, see § 3285.4), for closure systems with flexible air ducts and connectors, must be used around the duct collar and secured tightly to make all connections.

(b) If metal straps are used, they must be secured with galvanized sheet metal screws.

§ 3285.606

24 CFR Ch. XX (4-1-11 Edition)

(c) Metal ducts must be fastened to the collar with a minimum of three galvanized sheet metal screws equally spaced around the collar.

(d) Air conditioning or heating ducts must be installed in accordance with applicable requirements of the duct manufacturer installation instructions.

(e) The duct must be suspended or supported above the ground by straps or other means that are spaced at a maximum distance not to exceed 4'-0" or as otherwise permitted by the installation instructions. When straps are used to support a flexible type duct, the straps must be at least 1/2" wider than the spacing of the metal

spirals encasing the duct. The ducts must be installed such that the straps cannot slip between any two spirals and arranged under the floor to prevent compression or kinking in any location, as shown in Figures A and B to this section. In-floor crossover ducts are permitted, in accordance with § 3285.606(g).

(f) Crossover ducts outside the thermal envelope must be insulated with materials that conform to designs consistent with part 3280, subpart F of this chapter.

(g) In-floor or ceiling crossover duct connections must be installed and sealed to prevent air leakage.

Figure A to §3285.606 – Crossover Duct Installation with Two Connecting Ducts.

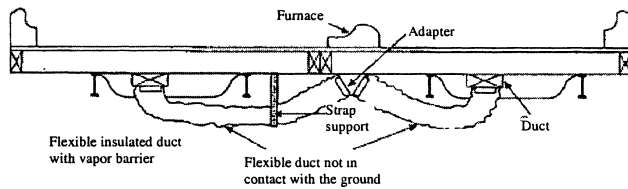

NOTES: 1. This system is typically used when a crossover duct has not been built into the floor and the furnace is outside the I-Beam. With this type of installation, it is

necessary for two flexible ducts to be installed. 2. The crossover duct must be listed for exterior use.

Figure B to §3285.606 Crossover Duct Installation with One Connecting Duct.

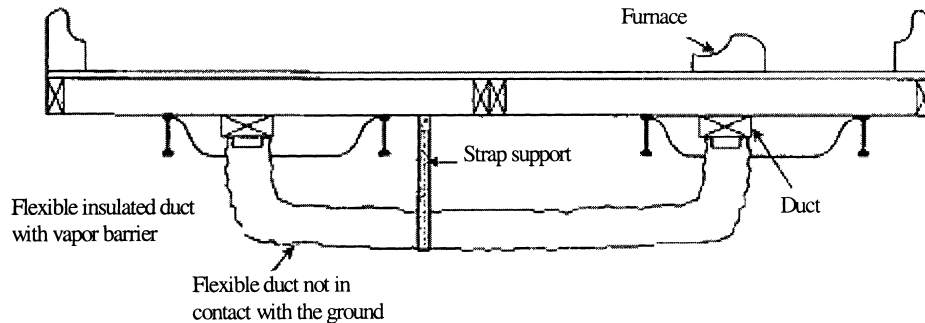

NOTES: 1. This system is typically used when a crossover duct has not been built into the floor and the furnace is situated directly

over the main duct in one section of the home. A single flexible duct is then used to connect the two sections to each other.

2. The crossover duct must be listed for exterior use.

Subpart H—Electrical Systems and Equipment

§ 3285.701 Electrical crossovers.

Multi-section homes with electrical wiring in more than one section require crossover connections to join all sections of the home. The crossover must be designed in accordance with part 3280, subpart I of this chapter, and completed in accordance with the directions provided in the installation instructions.

§ 3285.702 Miscellaneous lights and fixtures.

(a) When the home is installed, exterior lighting fixtures, ceiling-suspended (paddle) fans, and chain-hung lighting fixtures are permitted to be installed in accordance with their listings and part 3280, subpart I of this chapter.

(b) *Grounding.* (1) All the exterior lighting fixtures and ceiling fans installed per § 3285.702(a) must be grounded by a fixture-grounding device or by a fixture-grounding wire.

(2) For chain-hung lighting fixtures, as shown in Figure A to this section, both a fixture-grounding device and a fixture-grounding wire must be used. The identified conductor must be the neutral conductor.

(c) Where lighting fixtures are mounted on combustible surfaces such as hardboard, a limited combustible or noncombustible ring, as shown in Figures A and B to this section, must be installed to completely cover the combustible surface exposed between the fixture canopy and the wiring outlet box.

(d) *Exterior lights.* (1) The junction box covers must be removed and wire-to-wire connections must be made using listed wire connectors.

(2) Wires must be connected black-to-black, white-to-white, and equipment ground-to-equipment ground.

(3) The wires must be pushed into the box, and the lighting fixture must be secured to the junction box.

(4) The lighting fixture must be caulked around its base to ensure a watertight seal to the sidewall.

(5) The light bulb must be installed and the globe must be attached.

(e) *Ceiling fans.* (1) Ceiling-suspended (paddle) fans must be connected to junction box listed and marked for ceiling fan application, in accordance with Article 314.27(b) of the National Electrical Code, NFPA No. 70-2005 (incorporated by reference, see § 3285.4); and

(2) The ceiling fan must be installed with the trailing edges of the blades at least 6 feet 4 inches above the finished floor; and

(3) The wiring must be connected in accordance with the product manufacturer installation instructions.

(f) *Testing.* (1) After completion of all electrical wiring and connections, including crossovers, electrical lights, and ceiling fans, the electrical system must be inspected and tested at the site, in accordance with the testing requirements of § 3280.810(b) of this chapter.

(2) The installation instructions must indicate that each manufactured home must be subjected to the following tests:

(i) An electrical continuity test to ensure that metallic parts are effectively bonded;

(ii) Operational tests of all devices and utilization equipment, except water heaters, electric ranges, electric furnaces, dishwashers, clothes washers/dryers, and portable appliances, to demonstrate that they are connected and in working order; and

(iii) For electrical equipment installed or completed during installation, electrical polarity checks must be completed to determine that connections have been made properly. Visual verification is an acceptable electrical polarity check.

Figure A to § 3285.702 Typical Installation of Chain-Hung Lighting Fixture.

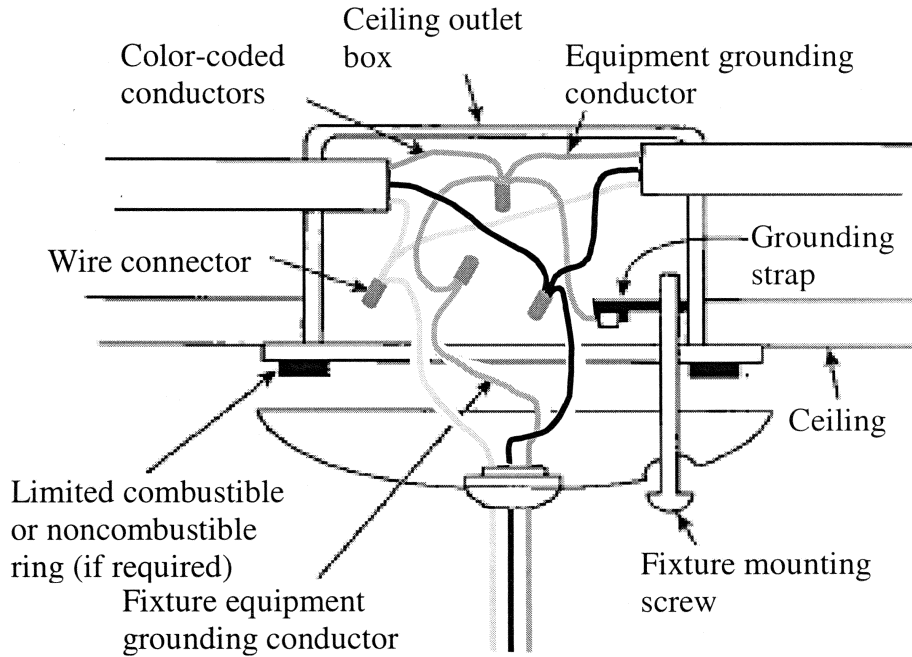
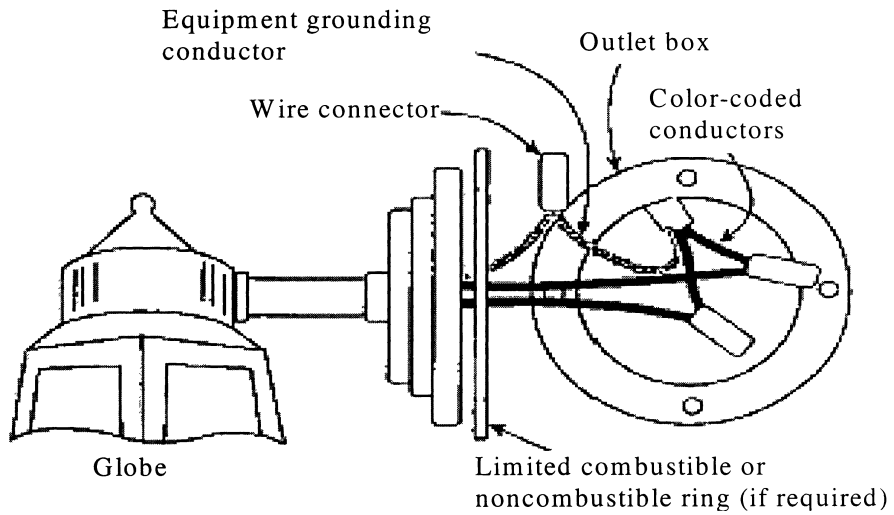

Figure B to § 3285.702 Typical Installation of Surface-Mounted Exterior Lighting Fixture.



[72 FR 59362, Oct. 19, 2007; 72 FR 62308, Nov. 2, 2007]

§ 3285.703 Smoke alarms.

Smoke alarms must be functionally tested in accordance with applicable requirements of the smoke alarm manufacturer instructions and must be consistent with § 3280.208 of this chapter.

§ 3285.704 Telephone and cable TV.

Refer to § 3285.906 for considerations pertinent to installation of telephone and cable TV.

Subpart I—Exterior and Interior Close-Up

§ 3285.801 Exterior close-up.

(a) Exterior siding and roofing necessary to join all sections of the home must be installed according to the product manufacturer installation instructions and must be fastened in accordance with designs and manufacturer instructions, consistent with §§ 3280.305 and 3280.307 of this chapter. Exterior close-up strips/trim must be fastened securely and sealed with exterior sealant (see figure A to this section).

(b) *Joints and seams.* All joints and seams in exterior wall coverings that were disturbed during location of the home must be made weatherproof.

(c) Prior to installing the siding, the polyethylene sheeting covering exterior walls for transit must be completely removed.

(d) Prior to completing the exterior close-up, any holes in the roofing must

be made weatherproof and sealed with a sealant or other material that is suitable for use with the roofing in which the hole is made.

(e) *Mate-line gasket.* The home manufacturer must provide materials and designs for mate-line gaskets or other methods designed to resist the entry of air, water, water vapor, insects, and rodents at all mate-line locations exposed to the exterior (see Figure B to this section).

(f) *Hinged roofs and eaves.* Hinged roofs and eaves must be completed during installation in compliance with all requirements of the Manufactured Home Construction and Safety Standards (24 CFR part 3280) and the Manufactured Home Procedural and Enforcement Regulations (24 CFR part 3282). Unless exempted by the following provisions, hinged roofs are also subject to a final inspection for compliance with the Manufactured Home Construction and Safety Standards (24 CFR part 3280) by the IPIA or a qualified independent inspector acceptable to the IPIA. Homes with hinged roofs that are exempted from IPIA inspection are instead to be completed and inspected in accordance with the Manufactured Home Installation Program (24 CFR part 3286). This includes homes:

(1) That are designed to be located in Wind Zone I;

(2) In which the pitch of the hinged roof is less than 7:12; and

(3) In which fuel burning appliance flue penetrations are not above the hinge.

FIGURE A to §3285.801 Installation of Field-Applied Horizontal Lap Siding

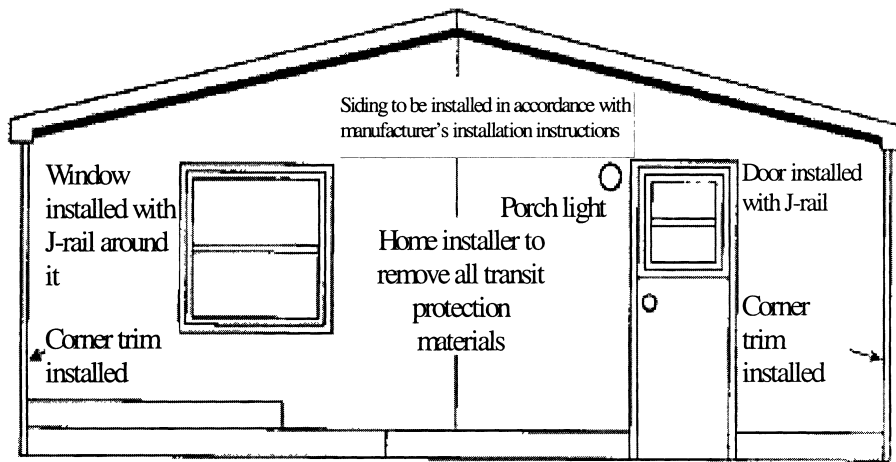

NOTES:

1. Multi-section homes with horizontal-lap siding can be shipped with no siding on the front and rear end walls.

2. The manufacturer must install doors/windows trimmed with J-rail or the equivalent and protect all exposed materials not designed for exposure to the weather with

plastic sheeting for transport. Siding, starter trim, and vents may be shipped loose in the home for installation on set-up.

3. All home installers must ensure that all field installed trim, windows, doors, and other openings are properly sealed according to the siding manufacturer installation instructions.

Figure B to § 3285.801 Mate-Line Gasket.

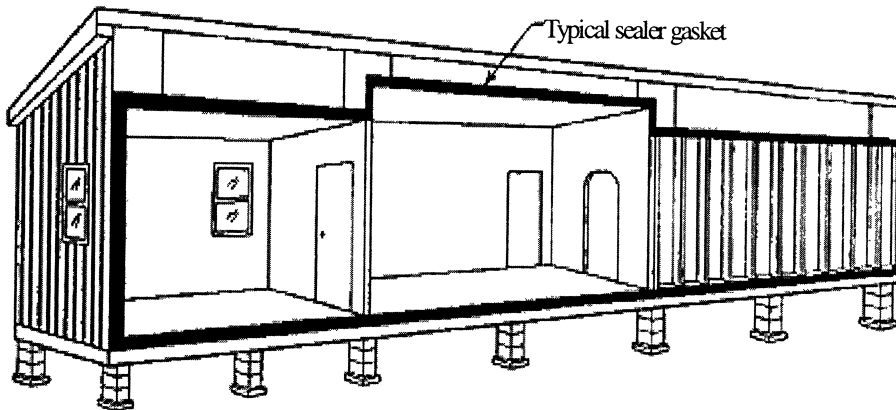

NOTE: On multi-section manufactured homes, install the sealer gasket on the ceiling, end walls, and floor mate-line prior to joining the sections together.

§ 3285.802 Structural interconnection of multi-section homes.

(a) For multi-section homes, structural interconnections along the interior and exterior at the mate-line are necessary to join all sections of the home.

(b) Structural interconnection must be designed in accordance with the requirements located in § 3280.305 of this chapter to ensure a completely integrated structure.

(c) Upon completion of the exterior close-up, no gaps are permitted between the structural elements being interconnected along the mate-line of multi-section homes. However, prior to completion of the exterior close-up, gaps that do not exceed one inch are permitted between structural elements provided:

(1) The gaps are closed before completion of close-up;

(2) The home sections are in contact with each other; and

(3) The mating gasket is providing a proper seal. All such gaps must be shimmed with dimensional lumber, and fastener lengths used to make connections between the structural elements must be increased to provide adequate penetration into the receiving member.

§ 3285.803 Interior close-up.

(a) All shipping blocking, strapping, or bracing must be removed from appliances, windows, and doors.

(b) Interior close up items necessary to join all sections of the home or items subject to transportation damage may be packaged or shipped with the home for site installation.

(c) Shipped-loose wall paneling necessary for the joining of all sections of the home must be installed by using polyvinyl acetate (PVA) adhesive on all framing members and fastened with minimum 1½ inch long staples or nails at 6 inches on center panel edges and 12 inches on center in the field, unless alternative fastening methods are permitted in the installation instructions (see Figure A to § 3285.803).

FIGURE A to §3285.803 - Installation of Interior Field-Applied Panels.

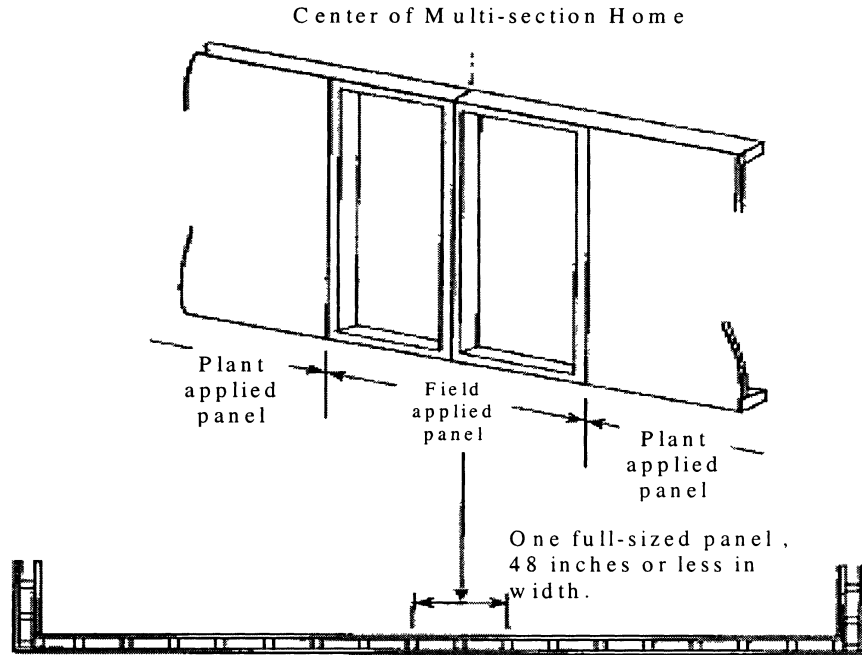

NOTE: Specific designs must be approved by a DAPIA and included in the home manufacturer installation instructions.

Subpart J—Optional Information for Manufacturer’s Installation Instructions

§ 3285.804 Bottom board repair.

(a) The bottom board covering must be inspected for any loosening or areas that might have been damaged or torn during installation or transportation. Any missing insulation is to be replaced prior to closure and repair of the bottom board.

(b) Any splits or tears in the bottom board must be resealed with tape or patches in accordance with methods provided in the manufacturers installation instructions.

(c) Plumbing P-traps must be checked to be sure they are well-insulated and covered.

(d) All edges of repaired areas must be taped or otherwise sealed.

§ 3285.901 General.

The planning and permitting processes, as well as utility connection, access, and other requirements, are outside of HUD’s authority and may be governed by LAHJs. These Model Installation Standards do not attempt to comprehensively address such requirements. However, HUD recommends that the manufacturer’s installation instructions include the information and advisories in this Subpart J, in order to protect the manufactured home, as constructed in accordance with the MHCSS.

§ 3285.902 Moving manufactured home to location.

It is recommended that the installation instructions indicate that the LAHJ be informed before moving the manufactured home to the site. It is

also recommended that the installation instructions indicate that the manufactured home is not to be moved to the site until the site is prepared in accordance with subpart C of this part and when the utilities are available as required by the LAHJ. Examples of related areas that might be addressed in the installation instructions for meeting this recommendation include:

(a) *Access for the transporter.* Before attempting to move a home, ensure that the transportation equipment and home can be routed to the installation site and that all special transportation permits required by the LAHJ have been obtained.

(b) *Drainage structures.* Ditches and culverts used to drain surface runoff meet the requirements of the LAHJ and are considered in the overall site preparation.

§ 3285.903 Permits, alterations, and on-site structures.

It is recommended that the installation instructions include the following information related to permits, alterations, and on-site structures:

(a) *Issuance of permits.* All necessary LAHJ fees should be paid and permits should be obtained, which may include verification that LAHJ requirements regarding encroachments in streets, yards, and courts are obeyed and that permissible setback and fire separation distances from property lines and public roads are met.

(b) *Alterations.* Prior to making any alteration to a home or its installation, contact the LAHJ to determine if plan approval and permits are required.

(c) *Installation of on-site structures.* Each accessory building and structure is designed to support all of its own live and dead loads, unless the structure, including any attached garage, carport, deck, and porch, is to be attached to the manufactured home and is otherwise included in the installation instructions or designed by a registered professional engineer or registered architect.

§ 3285.904 Utility system connections.

(a) It is recommended that the manufacturer's installation instructions indicate the following procedures be used

prior to making any utility system connection:

(1) Where an LAHJ and utility services are available, that the LAHJ and all utility services each be consulted before connecting the manufactured home to any utilities, or

(2) Where no LAHJ exists and utility services are available, that the utilities be consulted before connecting the manufactured home to any utility service; or

(3) In rural areas where no LAHJ or utility services are available, that a professional be consulted prior to making any system connections.

(b) *Qualified personnel.* Only qualified personnel familiar with local requirements are permitted to make utility site connections and conduct tests.

(c) *Drainage system.* The main drain line must be connected to the site's sewer hookup, using an elastomeric coupler or by other methods acceptable to the LAHJ, as shown in Figure A to this section.

(d) *Fuel supply system.*

(1) *Conversion of gas appliances.* A service person acceptable to the LAHJ must convert the appliance from one type of gas to another, following instructions by the manufacturer of each appliance.

(2) *Orifices and regulators.* Before making any connections to the site supply, the inlet orifices of all gas-burning appliances must be checked to ensure they are correctly set up for the type of gas to be supplied.

(3) *Connection procedures.* Gas-burning appliance vents must be inspected to ensure that they are connected to the appliance and that roof jacks are properly installed and have not come loose during transit.

(4) *Gas appliance start-up procedures.* The LAHJ should be consulted concerning the following gas appliance startup procedures:

(i) One at a time, opening equipment shutoff valves, lighting pilot lights when provided, and adjusting burners and spark igniters for automatic ignition systems, in accordance with each appliance manufacturer instructions.

(ii) Checking the operation of the furnace and water heater thermostats.

Figure A to § 3285.904 – Connection to Site Sewer.

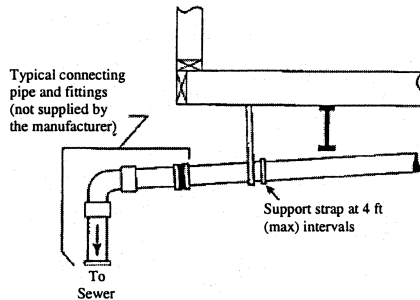

NOTE: Fittings in the drainage system that are subject to freezing, such as P-traps in the floor, are protected with insulation by the manufacturer. Insulation must be replaced if it is removed for access to the P-trap.

§ 3285.905 Heating oil systems.

It is recommended that the installation instructions include the following information related to heating oil systems, when applicable:

(a) Homes equipped with oil burning furnaces should have their oil supply tank and piping installed and tested on-site, in accordance with NFPA 31, Standard for the Installation of Oil Burning Equipment, 2001 (incorporated by reference, see § 3285.4) or the LAHJ, whichever is more stringent.

(b) The oil burning furnace manufacturer's instructions should be consulted for pipe size and installation procedures.

(c) Oil storage tanks and pipe installations should meet all applicable local regulations.

(d) *Tank installation requirements.* (1) The tank should be located where it is accessible to service and supply and where it is safe from fire and other hazards.

(2) In flood hazard areas, the oil storage tank should be anchored and elevated to or above the design flood elevation, or anchored and designed to prevent flotation, collapse, or permanent lateral movement during the design flood.

(3) *Leak test procedure.* Before the system is operated, it should be checked for leaks in the tank and supply piping, in accordance with NFPA 31, Standard

for the Installation of Oil Burning Equipment, 2001 (incorporated by reference, see § 3285.4) or the requirements of the LAHJ, whichever is more stringent.

§ 3285.906 Telephone and cable TV.

It is recommended that the installation instructions explain that telephone and cable TV wiring should be installed in accordance with requirements of the LAHJ and the National Electrical Code, NFPA No. 70-2005 (incorporated by reference, see § 3285.4).

§ 3285.907 Manufacturer additions to installation instructions.

A manufacturer may include in its installation instructions items that are not required by this chapter as long as the items included by the manufacturer are consistent with the Model Installation Standards in this part and do not take the manufactured home out of compliance with the MHCSS.

PART 3286—MANUFACTURED HOME INSTALLATION PROGRAM

Subpart A—Generally Applicable Provisions and Requirements

- Sec.
- 3286.1 Purpose.
- 3286.2 Applicability.
- 3286.3 Definitions.
- 3286.5 Overview of installation program.
- 3286.7 Consumer information.
- 3286.9 Manufacturer shipment responsibilities.
- 3286.11 Temporary storage of units.
- 3286.13 Waiver of rights invalid.

Office of Asst. Sec. for Housing, HUD

§ 3286.1

3286.15 Consultation with the Manufactured Housing Consensus Committee (MHCC).

Subpart B—Certification of Installation in HUD-Administered States

- 3286.101 Purpose.
- 3286.102 Information provided by manufacturer.
- 3286.103 DAPIA-approved installation instructions.
- 3286.105 Requirement for installer licensing.
- 3286.107 Installation in accordance with standards.
- 3286.109 Inspection requirements—generally.
- 3286.111 Installer certification of installation.
- 3286.113 Information provided by retailer.
- 3286.115 Date of installation.
- 3286.117 Completion of sale date.

Subpart C—Installer Licensing in HUD-Administered States

- 3286.201 Purpose.
- 3286.203 Installation license required.
- 3286.205 Prerequisites for installation license.
- 3286.207 Process for obtaining installation license.
- 3286.209 Denial, suspension, or revocation of installation license.
- 3286.211 Expiration and renewal of installation licenses.

Subpart D—Training of Installers in HUD-Administered States

- 3286.301 Purpose.
- 3286.303 Responsibilities of qualified trainers.
- 3286.305 Installation trainer criteria.
- 3286.307 Process for obtaining trainer's qualification.
- 3286.308 Training curriculum.
- 3286.309 Continuing education—trainers and curriculum.
- 3286.311 Suspension or revocation of trainer's qualification.
- 3286.313 Expiration and renewal of trainer qualification.

Subpart E—Installer Responsibilities of Installation in HUD-Administered States

- 3286.401 Purpose.
- 3286.403 Licensing requirements.
- 3286.405 Installation suitability.
- 3286.407 Supervising work of crew.
- 3286.409 Obtaining inspection.
- 3286.411 Certifying installation.
- 3286.413 Recordkeeping.

Subpart F—Inspection of Installations in HUD-Administered States

- 3286.501 Purpose.

- 3286.503 Inspection required.
- 3286.505 Minimum elements to be inspected.
- 3286.507 Verifying installation.
- 3286.509 Reinspection upon failure to pass.
- 3286.511 Inspector qualifications.

Subpart G—Retailer Responsibilities in HUD-Administered States

- 3286.601 Purpose.
- 3286.603 At or before sale.
- 3286.605 After sale.
- 3286.607 Recordkeeping.

Subpart H—Oversight and Enforcement in HUD-Administered States

- 3286.701 Purpose.
- 3286.703 Failure to comply.
- 3286.705 Applicability of dispute resolution program.

Subpart I—State Programs

- 3286.801 Purpose.
- 3286.803 State qualifying installation programs.
- 3286.805 Procedures for identification as qualified installation program.
- 3286.807 Recertification required.
- 3286.809 Withdrawal of qualifying installation program status.
- 3286.811 Effect on other manufactured housing program requirements.
- 3286.813 Inclusion in state plan.

AUTHORITY: 42 U.S.C. 3535(d), 5404, and 5424.

SOURCE: 73 FR 35292, June 20, 2008, unless otherwise noted.

Subpart A—Generally Applicable Provisions and Requirements

§ 3286.1 Purpose.

(a) *Purpose.* The purpose of this part is to establish the regulations that are applicable to HUD's administration of an installation program that meets the requirements of sections 602 (42 U.S.C. 5401) and 605 (42 U.S.C. 5404) of the National Manufactured Housing Construction and Safety Standards Act of 1974. The purpose of this subpart A is to establish the regulations that are applicable with respect to all manufactured homes before they are sold to a purchaser. The requirements in subpart A apply regardless of whether the actual installation of a manufactured home is regulated by HUD or a state with a qualifying installation program.

(b) *Implementation.* This part is effective on October 20, 2008. Implementation will be undertaken in accordance

§ 3286.2

24 CFR Ch. XX (4-1-11 Edition)

with the phased-in schedule provided by notice published in the FEDERAL REGISTER.

§ 3286.2 Applicability.

(a) *All states.* The requirements in subpart A are applicable in all states.

(b) *States without installation programs.* The requirements in subparts B through H of this part are applicable only in those states where HUD is administering an installation program in accordance with this part.

(c) *States with installation programs.* The requirements in subpart I of this part are applicable to only those states that want to administer their own installation programs in lieu of the installation program administered by HUD in accordance with this part.

(d) *Exclusion.* None of the requirements of this part apply to:

(1) Any structure that a manufacturer certifies as being excluded from the coverage of the Act in accordance with § 3282.12 of this chapter; or

(2) Temporary housing units provided under the Robert T. Stafford Disaster Relief and Emergency Assistance Act (42 U.S.C. 5121 *et seq.*) to victims of Presidentially declared disasters, when the manufactured home is installed by persons holding an emergency contractor license issued by the state in which the home is sited or installed by the Federal Emergency Management Agency; or

(3) Any manufactured home after the initial installation of the home following the first purchase of the home in good faith for purposes other than resale. State installation programs may regulate subsequent installations of manufactured homes.

(4) Any manufactured home installed on Indian reservations.

§ 3286.3 Definitions.

The following definitions apply in this part, except as otherwise noted in the regulations in this part:

Act means the National Manufactured Housing Construction and Safety Standards Act of 1974, 42 U.S.C. 5401-5425.

Certification of installation means the certification, provided by an installer under the HUD-administered installation program in accordance with

§ 3286.111, that indicates that the manufactured home has been installed in compliance with the appropriate design and instructions and has been inspected as required by this part.

Defect means any defect in the performance, construction, components, or material of a manufactured home that renders the home or any part thereof not fit for the ordinary use for which it was intended.

Design Approval Primary Inspection Agency (DAPIA) means a state agency or private organization that has been accepted by the Secretary, in accordance with the requirement of subpart H of part 3282, to evaluate and either approve or disapprove manufactured home designs and quality control procedures.

Distributor means any person engaged in the sale and distribution of manufactured homes for resale.

HUD means the United States Department of Housing and Urban Development.

HUD-administered installation program means the installation program to be administered by HUD, in accordance with this part, in those states that do not have a qualifying installation program.

Installation means completion of work done specified in § 3286.505 to stabilize, support, anchor, and close up a manufactured home and to join sections of a multi-section manufactured home, when any such work is governed by the federal installation standards in part 3285 of this chapter or by state installation standards that are certified as part of a qualifying installation program.

Installation defect means any defect in the performance, installation, installation components, installation material, or close-up of a manufactured home that renders the home or any part thereof not fit for the ordinary use for which it was intended or otherwise takes the home out of compliance with the Manufactured Home Construction and Safety Standards in 24 CFR part 3280.

Installation design means drawings, specifications, sketches, and the related engineering calculations, tests, and data in support of the installation

configurations and systems to be incorporated in the installation of manufactured homes.

Installation instructions means DAPIA-approved instructions provided by the home manufacturer that accompany each new manufactured home and detail the home manufacturer requirements for support and anchoring systems and other work completed at the installation site to comply with the Model Manufactured Home Installation Standards in 24 CFR part 3285 and the Manufactured Home Construction and Safety Standards in 24 CFR part 3280.

Installation standards means the standards established by HUD in 24 CFR part 3285, or any set of state standards that the Secretary has determined provide protection to the residents of manufactured homes that equals or exceeds the protection provided by the standards in 24 CFR part 3285.

Installer means the person or entity who is retained to engage in, or who engages in, the business of directing, supervising, controlling, or correcting the initial installation of a manufactured home, as governed by part 3285 of this chapter.

Installer's license or *installation license* means the evidence that an installer has met the requirements for installing manufactured homes under the HUD-administered installation program. The term does not incorporate a state-issued installation license or certification, except to the extent provided in this part. The term does not imply that HUD approves or recommends an installer or warrants the work of an installer, and should not be used in any way that indicates HUD approval in violation of 18 U.S.C. 709.

Lessee means the first person who leases a manufactured home from a retailer after the initial installation.

Manufactured home means a structure, transportable in one or more sections, which, in the traveling mode, is 8 body feet or more in width or 40 body feet or more in length, or, when erected on-site, is 320 or more square feet, and which is built on a permanent chassis and designed to be used as a dwelling with or without a permanent foundation when connected to the required utilities, and includes the plumbing,

heating, air-conditioning, and electrical systems contained therein. The term also includes any structure that meets all the requirements of this paragraph except the size requirements and with respect to which the manufacturer voluntarily files a certification pursuant to § 3282.13 of this chapter and complies with the installation standards established under part 3285 and the construction and safety standards in part 3280 of this chapter, but such term does not include any self-propelled recreational vehicle. Calculations used to determine the number of square feet in a structure will include the total of square feet for each transportable section comprising the completed structure and will be based on the structure's exterior dimensions measured at the largest horizontal projections when erected on-site. These dimensions will include all expandable rooms, cabinets, and other projections containing interior space, but do not include bay windows. Nothing in this definition should be interpreted to mean that a manufactured home necessarily meets the requirements of HUD's Minimum Property Standards (HUD Handbook 4900.1) or that it is automatically eligible for financing under 12 U.S.C. 1709(b).

Manufactured Housing Consensus Committee, or *MHCC*, means the consensus committee established pursuant to section 604(a)(3) of the Act, 42 U.S.C. 5403(a)(3).

Manufacturer means any person engaged in manufacturing or assembling manufactured homes, including any person engaged in importing manufactured homes for resale.

Manufacturer's certification label means the permanent label that is required by § 3280.11 of this chapter to be affixed to each transportable section of each manufactured home.

Person includes, unless the context indicates otherwise, corporations, companies, associations, firms, partnerships, societies, and joint stock companies, as well as individuals, but does not include any agency of government or tribal government entity.

Professional engineer or *registered architect* means an individual or entity: licensed to practice engineering or architecture in a state; and subject to all

laws and limitations imposed by the state agency that regulates the applicable profession, and who is engaged in the professional practice of rendering service or creative work requiring education, training, and experience in architecture or engineering sciences and the application of special knowledge of the mathematical, physical, and engineering sciences in such professional or creative work as consultation, investigation, evaluation, planning or design, and supervision of construction for the purpose of securing compliance with specifications and design for any such work.

Purchaser means the first person purchasing a manufactured home in good faith for purposes other than resale.

Qualified trainer means a person who has met the requirements established in subpart D of this part to be recognized as qualified to provide training to installers for purposes of the HUD-administered installation program.

Qualifying installation program means an installation program that a state certifies, in accordance with the requirements set out in subpart I of this part, as meeting the requirements of 42 U.S.C. 5404(c)(3).

Resident means any person residing in the manufactured home.

Retailer means any person engaged in the sale, leasing, or distribution of new manufactured homes primarily to persons who in good faith purchase or lease a manufactured home for purposes other than resale, and, for purposes of this part, the term includes any manufacturer or distributor that sells a manufactured home directly to a purchaser.

Secretary means the Secretary of Housing and Urban Development.

Set up means any assembly or installation of a manufactured home on-site that includes aspects of work that are governed by parts 3280 or 3285 of this chapter.

State includes each of the 50 states, the District of Columbia, the Commonwealth of Puerto Rico, Guam, the Virgin Islands, and American Samoa.

§ 3286.5 Overview of installation program.

(a) *HUD-administered installation program.* HUD will administer the installa-

tion program, as established and set out in subparts A through H of this part, in a state unless that state administers its own qualifying installation program. The states in which HUD administers an installation program can be identified under this part by referring to a list on a Web site maintained by HUD or by calling HUD. For convenience only, the current URL of the Web site is <http://www.hud.gov/offices/hsg/sfh/mhs/mhshome.cfm> and the current toll-free telephone number to contact the HUD Office of Manufactured Housing Programs is 1-800-927-2891, extension 57.

(b) *State-administered installation programs.* States that have qualifying installation programs, as established through the procedures set out in subpart I of this part, will administer their own programs, except for generally applicable requirements in this subpart A.

(c) *Manufacturer and retailer requirements.* (1) Manufacturers and retailers are responsible for compliance of the home with the construction and safety standards in part 3280 of this chapter, in accordance with the Act and applicable regulations. Manufacturers and retailers must also comply with applicable requirements in this part relating to the installation of the manufactured home.

(2) In the installation instructions required pursuant to part 3285 of this chapter, the manufacturer must include instructions for supporting the manufactured home or sections of homes temporarily and protecting the interior of the manufactured home or sections of homes from damage, pending the first siting of the home for occupancy. The instructions must be adequate to assure that the temporary supports and weatherization used will be sufficient to prevent the home and its transportable sections from being brought out of conformance with the construction and safety standards in part 3280 of this chapter if the home or its sections is either:

(i) Stored at any location for more than 30 days; or

(ii) In the possession of any entity for more than 30 days.

(d) *HUD oversight.* The Secretary may take such actions as are authorized by

the Act to oversee the system established by the regulations in this part, as the Secretary deems appropriate.

§ 3286.7 Consumer information.

(a) *Manufacturer's consumer manual.* In each consumer manual provided by a manufacturer as required in § 3282.207 of this chapter, the manufacturer must include a recommendation that any home that has been reinstalled after its original installation should be inspected after it is set up, in order to assure that it has not been damaged and is properly installed.

(b) *Retailer disclosures before sale or lease.* Prior to execution of the sales contract to purchase or agreement to lease a manufactured home, the retailer must provide the purchaser or lessee with a consumer disclosure. This disclosure must be in a document separate from the sales or lease agreement. The disclosure must include the following information, as applicable:

(1) When the installation of the home is in a state that administers its own qualifying installation program, the consumer disclosure must clearly state that the home will be required to comply with all state requirements for the installation of the home;

(2) When the installation of the home is in a state that does not administer its own qualifying installation program, the consumer disclosure must clearly state that the home will be required to comply with federal requirements, including installation in accordance with federal installation standards set forth in 24 CFR part 3285 and certification by a licensed installer of installation work, regardless of whether the work is performed by the homeowner or anyone else, and when certification includes inspection by an appropriate person;

(3) For all homes, the home may also be required to comply with additional state and local requirements for its installation;

(4) For all homes, additional information about the requirements disclosed under paragraphs (b)(1) through (b)(4) of this section is available from the retailer and, in the case of the federal requirements, is available in part 3286 of Title 24 of the Code of Federal Regula-

tions and from the U.S. Department of Housing and Urban Development;

(5) For all homes, compliance with any additional federal, state, and local requirements, including a requirement for inspection of the installation of the home, may involve additional costs to the purchaser or lessee; and

(6) For all homes, a recommendation that any home that has been reinstalled after its original installation should be professionally inspected after it is set up, in order to assure that it has not been damaged in transit and is properly installed.

§ 3286.9 Manufacturer shipment responsibilities.

(a) *Providing information to HUD.* At or before the time that each manufactured home is shipped by a manufacturer, the manufacturer must provide HUD, through the Production Inspection Primary Inspection Agency (IPIA), in accordance with § 3282.552 of this chapter, with information, as applicable, about:

(1) The serial number and manufacturer's certification label number of the home;

(2) The manufacturer of the home; and

(3) The name and address of the retailer or distributor that has arranged for the home to be shipped.

(b) *Manufacturer's installation instructions.* The manufacturer is required to provide with each manufactured home, installation designs and instructions for the installation of the manufactured home that have been approved by a DAPIA. A DAPIA must give approval only if the installation designs and instructions provide equal or greater protection than the protection provided under the installation standards.

§ 3286.11 Temporary storage of units.

Pursuant to § 3286.5(c), the manufacturer is required to provide instructions for the temporary support and protection of the interior from damage of its manufactured homes or sections of homes. Every manufacturer, distributor, retailer, or installer that has possession of a home is required to support each transportable section of a manufactured home that is temporarily located on a site used by that

§ 3286.13

manufacturer, distributor, retailer, or installer in accordance with the manufacturer's instructions.

§ 3286.13 Waiver of rights invalid.

Any provision of a contract or agreement entered into by a manufactured home purchaser that seeks to waive any recourse to either the HUD installation program or a state-qualifying installation program is void.

§ 3286.15 Consultation with the Manufactured Housing Consensus Committee (MHCC).

The Secretary will seek input from the MHCC when revising the installation program regulations in this part 3286. Before publication of a proposed rule to revise these regulations, the Secretary will provide the MHCC with a 120-day opportunity to comment on such revision. The MHCC may send to the Secretary any of the MHCC's own recommendations to adopt new installation program regulations or to modify or repeal any of the regulations in this part. Along with each recommendation, the MHCC must set forth pertinent data and arguments in support of the action sought. The Secretary will either: Accept or modify the recommendation and publish it for public comment in accordance with section 553 of the Administrative Procedure Act (5 U.S.C. 553), along with an explanation of the reasons for any such modification; or reject the recommendation entirely, and provide to the MHCC a written explanation of the reasons for the rejection. This section does not supersede section 605 of the National Manufactured Housing Construction and Safety Standards Act.

Subpart B—Certification of Installation in HUD-Administered States

§ 3286.101 Purpose.

The purpose of this subpart B is to establish the systems for tracking and certifying a manufactured home installation that is to be completed in accordance with the HUD-administered installation program.

24 CFR Ch. XX (4-1-11 Edition)

§ 3286.102 Information provided by manufacturer.

(a) *Shipment of home to retailer or distributor.* At the time the manufactured home is shipped to a retailer or distributor, the manufacturer must provide notice to the retailer or distributor that tracking information for the home is being provided to HUD, and the information must be updated by the retailer or distributor in accordance with the requirements in § 3286.113. Such notice must include all of the information required in § 3286.9(a). The manufacturer is also encouraged to provide notice to the retailer that reminds the retailer of its other responsibilities under this part.

(b) *Manufacturer's installation instructions.* The manufacturer is required to include in its installation instructions for the home a notice that the home is required to be installed in accordance with:

(1) An installation design and instructions that have been provided by the manufacturer and approved by the Secretary directly or through review by the DAPIA; or

(2) An installation design and instructions that have been prepared and certified by a professional engineer or registered architect, that have been approved by the manufacturer and the DAPIA as providing a level of protection for residents of the home that equals or exceeds the protection provided by the federal installation standards in part 3285 of this chapter.

§ 3286.103 DAPIA-approved installation instructions.

(a) *Providing instructions to purchaser or lessee.* (1) For each manufactured home sold or leased to a purchaser or lessee, the retailer must provide the purchaser or lessee with a copy of the manufacturer's DAPIA-approved installation instructions for the home.

(2) If the installation requires a design that is different from that provided by the manufacturer in paragraph (a)(1) of this section, the installation design and instructions must be prepared and certified by a professional engineer or registered architect, that have been approved by the manufacturer and the DAPIA as providing a level of protection for residents of the

home that equals or exceeds the protection provided by the federal installation standards in part 3285 of this chapter.

(b) *Providing instructions to installer.* When the retailer or manufacturer agrees to provide any set up in connection with the sale of the home, the retailer or manufacturer must provide a copy of the approved installation instructions required in paragraph (a)(1) of this section or, as applicable, installation design and instructions required in paragraph (a)(2) of this section to each company or, in the case of sole proprietor, to each individual who performs set up or installation work on the home.

§ 3286.105 Requirement for installer licensing.

(a) *Installer Licensing.* The installer that installs a manufactured home in a state that does not have a qualifying installation program must be certified or licensed in accordance with the requirements in subpart C of this part.

(b) *Use of licensed installer.* When the retailer or manufacturer agrees to provide any set up in connection with the sale or lease of the home, the retailer or manufacturer must ensure that the installer is licensed in accordance with these regulations.

§ 3286.107 Installation in accordance with standards.

(a) *Compliance with installation requirements.* (1) For purposes of determining installer compliance, a manufactured home that is subject to the requirements of this subpart B must be installed in accordance with:

(i) An installation design and instructions that have been provided by the manufacturer and approved by the Secretary directly or through review by the DAPIA; or

(ii) An installation design and instructions that have been prepared and certified by a professional engineer or registered architect, that have been approved by the manufacturer and the DAPIA as providing a level of protection for residents of the home that equals or exceeds the protection provided by the federal installation standards in part 3285 of this chapter.

(2) If the installation instructions do not comply with the installation standards, the manufacturer is responsible for any aspect of installation that is completed in accordance with the installation instructions and that does not comply with the installation standards.

(3) All installation work must be in conformance with accepted practices to ensure durable, livable, and safe housing, and must demonstrate acceptable workmanship reflecting, at a minimum, journeyman quality of work of the various trades.

(4) Except as set out in paragraph (a)(2) of this section, all installation defects due to the work of the installer are the responsibility of the installer or retailer or manufacturer that retained the installer and must be corrected.

(5) If the manufacturer or retailer retains the installer, they are jointly and severally responsible with the installer for correcting installation defects.

(6) Installation defects must be corrected within 60 days after the date of discovery of the installation defect.

(b) *Secretarial approval of manufacturer's designs.* A manufacturer that seeks a Secretarial determination under paragraph (a) of this section that its installation designs and instructions provide protection to residents of manufactured homes that equals or exceeds the protection provided by the HUD federal installation standards in part 3285 of this chapter must send the request for such determination and a copy of the applicable designs and instructions to: Administrator, Office of Manufactured Housing Programs, HUD, 451 Seventh Street, SW., Room 9164, Washington, DC 20410-8000, or to a fax number or e-mail address obtained by calling the Office of Manufactured Housing Programs at the toll-free telephone number 1-800-927-2891, extension 57.

(c) *Compliance with construction and safety standards.* The installer must not take the home out of compliance with the construction and safety standards applicable under part 3280 of this chapter.

(d) *Homeowner installations.* The purchaser of a home sited in a state in

§ 3286.109

which HUD administers the installation program may perform installation work on the home that is in accordance with paragraph (a) of this section, provided that the work is certified in accordance with § 3286.111.

(e) *Compliance with construction and safety standards.* This rule does not alter or affect the requirements of the Act concerning compliance with the construction and safety standards, and the implementing regulations in parts 3280 and 3282 of this chapter, which apply regardless of where the work is completed.

§ 3286.109 Inspection requirements—generally.

The installer or the retailer must arrange for the inspection of the installation work on any manufactured home that is sited in a state without a qualifying installation program. Before the home can be occupied, the installer must certify, and the inspector must verify, the home as having been installed in conformance with the requirements of § 3286.107(a). The requirements for installer certification are set out in subpart E of this part.

§ 3286.111 Installer certification of installation.

(a) *Certification required.* When the installation work is complete, a licensed installer must visit the jobsite and certify that:

(1) The manufactured home has been installed in accordance with:

(i) An installation design and instructions that have been provided by the manufacturer and approved by the Secretary directly or through review by the DAPIA; or

(ii) An installation design and instructions that have been prepared and certified by a professional engineer or registered architect, that have been approved by the manufacturer and the DAPIA as providing a level of protection for residents of the home that equals or exceeds the protection provided by the federal installation standards in part 3285 of this chapter.

(2) The installation of the home has been inspected as required by § 3286.503 and an inspector has verified the installation as meeting the requirements of this part.

(3) All installation defects brought to the installer's attention have been corrected.

(b) *Recipients of certification.* The installer must provide a signed copy of its certification to the retailer that contracted with the purchaser or lessee for the sale or lease of the home, and to the purchaser or other person with whom the installer contracted for the installation work.

§ 3286.113 Information provided by retailer.

(a) *Tracking information.* Within 30 days from the time a purchaser or lessee enters into a contract to purchase or lease a manufactured home, the retailer or distributor of the home must provide HUD with the following information:

(1) The home's serial number and manufacturer's certification label number;

(2) The name and address of the retailer or distributor that is selling or leasing the home;

(3) The state and address where the home is to be sited, and, if known, the name of the local jurisdiction; and

(4) The name of the purchaser or lessee.

(b) *Installation information.* Within 30 days from the date of installation, the retailer or distributor of the home must provide HUD with the following information:

(1) The name, address, telephone number, and license number of the licensed installer;

(2) The date of installer certification of completion of the installation;

(3) The date a qualified inspector verified the installation as being in compliance with the requirements of this part; and

(4) The name, address, and telephone number of the qualified inspector who performed the inspection of the installation as required by § 3286.109.

(c) *Method of providing information.* (1) The retailer or distributor must provide a copy of the information set forth in paragraphs (a) and (b) of this section to HUD by providing a copy of the information to HUD by facsimile, e-mail, or first-class or overnight delivery.

(2) The information must be sent to: Administrator, Office of Manufactured

Housing Programs, HUD, 451 Seventh Street, SW., Room 9164, Washington, DC 20410-8000, or to a fax number or e-mail address obtained by calling the Office of Manufactured Housing Programs. For convenience only, the URL of the Web site is <http://www.hud.gov/offices/hsg/sfh/mhs/mhshome.cfm> and the toll-free telephone number to contact the Office of Manufactured Housing Programs is 1-800-927-2891, extension 57.

(d) *Correcting information.* If the information provided by the retailer changes after it has been provided to HUD, the retailer must correct the information within 10 business days after the retailer learns of the change.

(e) *Record retention requirements.* The retailer or distributor must maintain a copy of the records required in paragraphs (a) and (b) of this section for 3 years from the date of installation, as under § 3286.115.

§ 3286.115 Date of installation.

The date of installation will be the date the installer has certified that all required inspections have been completed, all utilities are connected, and the manufactured home is ready for occupancy as established, if applicable, by a certificate of occupancy, except as follows: If the manufactured home has not been sold to the first person purchasing the home in good faith for purposes other than resale by the date the home is ready for occupancy, the date of installation is the date of the purchase agreement or sales contract for the manufactured home.

§ 3286.117 Completion of sale date.

(a) *Date of sale defined.* For purposes of determining the responsibilities of a manufacturer, retailer, or distributor under subpart I of part 3282 of this chapter, the sale of a manufactured home will not be considered complete until all the goods and services that the manufacturer, retailer, or distributor agreed to provide at the time the contract was entered into have been provided.

(b) *Compliance with construction and safety standards.* When a retailer or manufacturer is providing the installation and an installer installs a home in such a way as to create an imminent

safety hazard or cause the home to not comply with the construction and safety standards in part 3280 of this chapter, and those issues are discovered during the installation of the home, the sale or lease of the home is not complete until the home is corrected.

Subpart C—Installer Licensing in HUD-Administered States

§ 3286.201 Purpose.

The purpose of this subpart C is to establish the requirements for a person to qualify to install a manufactured home in accordance with the HUD-administered installation program. Installers will be required to meet licensing, training, and insurance requirements established in this part. Licensed installers will self-certify their installations of manufactured homes to be in compliance with the Model Manufactured Home Installation Standards in part 3285 of this chapter. In order for such an installer to self-certify compliance with the installation standards, the installer will have to assure that acceptable inspections, as required in subpart F of this part, are performed.

§ 3286.203 Installation license required.

(a) *Installation license required.* (1) Any individual or entity that engages in the business of directing, supervising, or controlling initial installations of new manufactured homes in a state without a qualifying installation program must itself have, or must employ someone who has, a valid manufactured home installation license issued in accordance with the requirements of this subpart C. For each installation covered under these requirements, the licensed installer, and any company that employs the licensed installer, will be responsible for the proper and competent performance of all employees working under the licensed installer's supervision and for assuring that the installation work complies with this part.

(2) A business that employs a licensed installer to represent the business and hold the installer's license retains primary responsibility for performance of the installation work in

§ 3286.205

24 CFR Ch. XX (4-1-11 Edition)

compliance with the requirements of this part.

(3) A license is not required for individuals working as direct employees of a licensed installer or for the company that employs a licensed installer, provided that those individuals are supervised by a licensed installer.

(4) The installer must display an original or a copy of a valid installation license at the site of the installation while performing work related to the installation of the home.

(5) The installer is responsible for understanding and following, as applicable, the approved manufacturer installation instructions and any alternative installation design and instructions that have been certified by a professional engineer or registered architect, that have been approved by the manufacturer and DAPIA as providing a level of protection for residents of the home that equals or exceeds the protection provided by the federal installation standards in part 3285 of this chapter.

(b) *Installation license not required.* An installation license is not required for:

(1) Site preparation that is not subject to the requirements of part 3285 of this chapter;

(2) Connection of utilities to the manufactured home;

(3) Add-ons subject to the requirements of §3282.8(j) of this chapter;

(4) Temporary installations on dealer, distributor, manufacturer, or other sales or storage lots, when the manufactured home is not serving as an occupied residence;

(5) Home maintenance, repairs, or corrections, or other noninstallation-related work performed by the home manufacturer under warranty or other obligations or service agreements;

(6) Installations performed by authorized representatives of the Federal Emergency Management Agency in order to provide emergency housing after a natural disaster; or

(7) Work performed at the home site that is not covered by the federal installation standards in part 3285 of this chapter or the requirements of this part.

§ 3286.205 Prerequisites for installation license.

(a) *Required experience.* (1) In order to obtain an installation license to perform manufactured home installations under the HUD-administered installation program, an individual must meet at least one of the following minimum experience requirements:

(i) 1,800 hours of experience installing manufactured homes;

(ii) 3,600 hours of experience in the construction of manufactured homes;

(iii) 3,600 hours of experience as a building construction supervisor;

(iv) 1,800 hours as an active manufactured home installation inspector;

(v) Completion of one year of a college program in a construction-related field; or

(vi) Any combination of experience or education from paragraphs (a)(1)(i) through (a)(1)(v) of this section that totals 3,600 hours.

(2) An installer who is certified or licensed to perform manufactured home installations in a state with a qualifying installation program may be exempted by the Secretary from complying with these experience requirements, if the Secretary determines that the state requirements are substantially equal to the HUD experience requirements.

(b) *Required training—(1) Initial applicant.* An applicant for an installation license must complete 12 hours of training, at least 4 hours of which must consist of training on the federal installation standards in part 3285 of this chapter and the installation program regulations in this part. An installer who is licensed to perform installations in a state with a qualified installation program may postpone the training requirements of this section until October 20, 2009.

(2) *Renewal applicant.* In order to qualify for renewal of an installation license, the licensed installer must complete 8 hours of continuing education during the 3-year license period, including in any particular subject area that may be required by HUD to be covered in order to assure adequate understanding of installation requirements.

(3) The training required under this paragraph (b) must be conducted by

trainers who meet the requirements of subpart D of this part and must meet the curriculum requirements established in § 3286.308 or § 3286.309, as applicable.

(c) *Testing.* An applicant for an installation license must have successfully received a passing grade of 70 percent on a HUD-administered or HUD-approved examination covering the Manufactured Home Installation Program and the federal installation standards in part 3285.

(d) *Surety bond or insurance.* An applicant for an installation license must provide evidence of and must maintain, when available in the state of installation, a surety bond or insurance that will cover the cost of repairing all damage to the home and its supports caused by the installer during the installation up to and including replacement of the home. HUD may require the licensed installer to provide proof of the surety bond or insurance at any time. The licensed installer must notify HUD of any changes or cancellations with the surety bond or insurance coverage.

§ 3286.207 Process for obtaining installation license.

(a) *Where to apply.* An applicant for an initial or renewed installation license must provide the applicant's legal name, address, and telephone number to HUD. The application, with all required information, must be sent to: Administrator, Office of Manufactured Housing Programs, HUD, 451 Seventh Street, SW., Room 9164, Washington, DC 20410-8000, or to a fax number or e-mail address obtained by calling the Office of Manufactured Housing Programs. For convenience only, the current URL of the Web site is <http://www.hud.gov/offices/hsg/sfh/mhs/mhshome.cfm>, and the current toll-free telephone number to contact the Office of Manufactured Housing Programs is 1-800-927-2891, extension 57.

(b) *Proof of experience.* Every applicant for an initial installation license must submit verification of the experience required in § 3286.205(a). This verification may be in the form of statements by past or present employers or a self-certification that the applicant meets those experience require-

ments, but HUD may contact the applicant for additional verification at any time. The applicant must also provide to HUD employment information relevant to the applicant's experience as an installer, including the dates and type of such employment. An installer who is certified or licensed to perform manufactured home installations in a state with a qualifying installation program may seek an exemption from the experience requirement by submitting proof of such certification or license.

(c) *Proof of training.* Every applicant for an initial installation license, or the renewal of an installation license, must submit verification of successful completion of the training required in § 3286.205(b). This verification must be in the form of a certificate of completion from a qualified trainer that the applicant has completed the requisite number of hours of a qualifying curriculum, as set out in § 3286.308 or § 3286.309.

(d) *Proof of surety bond or insurance.* Every applicant for an installation license must submit the name of the applicant's surety bond or insurance carrier and the number of the policy required in § 3286.205(d).

(e) *Other application submissions.* (1) Every applicant for an installation license must submit a list of all states in which the applicant holds a similar installation certification or license, and a list of all states in which the applicant has had such a certification or license revoked, suspended, or denied.

(2) When the examination is not administered by HUD, every applicant for an initial installation license must submit certification of a passing grade on the examination required by § 3286.205(c).

(f) *Issuance or denial of an installation license.* (1) When HUD confirms that an applicant has met the requirements in this subpart C, HUD will either:

(i) Provide an installation license to the applicant that, as long as the installation license remains in effect, establishes the applicant's qualification to install manufactured homes in a state subject to the HUD-administered installation program; or

(ii) Provide a written explanation of why HUD deems the applicant to not

§ 3286.209

24 CFR Ch. XX (4-1-11 Edition)

qualify for an installation license, including on grounds applicable under § 3286.209 for suspension or revocation of an installation license and any other specified evidence of inability to adequately meet the requirements of this part.

(2) An applicant who is denied an installation license under this subpart C, other than for failure to pass the installation license test, may request from HUD an opportunity for a presentation of views, in accordance with subpart D of part 3282 of this chapter, for the purpose of establishing the applicant's qualifications to obtain an installation license.

(g) *Assignment of license prohibited.* An installation license issued under this part may not be transferred, assigned, or pledged to another entity or individual.

§ 3286.209 Denial, suspension, or revocation of installation license.

(a) *Oversight.* The Secretary may make a continuing evaluation of the manner in which each licensed installer is carrying out his or her responsibilities under this subpart C.

(b) *Denial, suspension, or revocation.* After notice and an opportunity for a presentation of views in accordance with subpart D of part 3282 of this chapter, the Secretary may deny, suspend, or revoke an installation license under this part. An installation license may be denied, suspended, or revoked for, among other things:

- (1) Providing false records or information to any party;
- (2) Refusing to submit information that the Secretary requires to be submitted;
- (3) Failure to comply with applicable requirements of parts 3285, 3286, or 3288 of this chapter;
- (4) Failure to take appropriate actions upon a failed inspection, as provided in § 3286.509;
- (5) Fraudulently obtaining or attempting to obtain an installation license, or fraudulently or deceptively using an installation license;
- (6) Using or attempting to use an expired, suspended, or revoked installation license;
- (7) Violating state or federal laws that relate to the fitness and qualifica-

tion or ability of the applicant to install homes; or

(8) Engaging in poor conduct or workmanship as evidenced by one or more of the following:

- (i) Installing one or more homes that fail to meet the requirements of § 3286.107;
- (ii) An unsatisfied judgment in favor of a consumer;
- (iii) Repeatedly engaging in fraud, deception, misrepresentation, or knowing omissions of material facts relating to installation contracts;
- (iv) Having a similar state installation license or certification denied, suspended, or revoked;
- (v) Having the renewal of a similar state installation license or certification denied for any cause other than failure to pay a renewal fee; or
- (vi) Failure to maintain the surety bond or insurance required by § 3286.205(d).

(c) *Other criteria.* In deciding whether to suspend or revoke an installation license, the Secretary will consider the impact of the suspension or revocation on other affected parties and will seek to assure that the sales and siting of manufactured homes are not unduly disrupted.

(d) *Reinstating an installation license.* An installer whose installation license has been denied, suspended, or revoked may submit a new application in accordance with this subpart C. Installers whose installation licenses have been suspended may also reinstate their installation licenses in any manner provided under the terms of their suspensions.

§ 3286.211 Expiration and renewal of installation licenses.

(a) *Expiration.* Each installation license issued or renewed under this subpart C will expire 3 years after the date of its issuance or renewal.

(b) *Renewal.* An application for the renewal of an installation license must include the information required by, and must be submitted to, HUD in accordance with § 3286.207, and must be submitted at least 60 days before the date the license expires. Any person applying for a license renewal after the date the license expires must apply for a new installation license following the

requirements established under this subpart C for application for an initial installation license.

Subpart D—Training of Installers in HUD-Administered States

§ 3286.301 Purpose.

The purpose of this subpart D is to establish the requirements for a person to qualify to provide the training required under subpart C of this part. This training is required for manufactured home installers who want to be licensed in accordance with the HUD-administered installation program.

§ 3286.303 Responsibilities of qualified trainers.

(a) *Curriculum and hours.* In providing training to installers for the purpose of qualifying installers under the HUD-administered installation program, qualified trainers must adequately address the curriculum and instruction-time requirements established in subparts C and D of this part.

(b) *Attendance records.* Qualified trainers must maintain records of the times, locations, names of attendees at each session, and content of all courses offered. When an attendee misses a significant portion of any training session, the trainer must assure that the attendee makes up the missed portion of the instruction.

(c) *Certificates of completion of training.* Qualified trainers must provide certificates of completion to course attendees that indicate the level of compliance with the applicable curriculum and time requirements under subparts C and D of this part.

(d) *Record retention.* All records maintained by trainers and continuing education providers must be retained for 3 years, and must be made available to HUD upon request.

(e) *Testing of installers.* Qualified trainers may be authorized to administer the installation license testing required for initial licensing of installers, as set forth in § 3286.205(c).

§ 3286.305 Installation trainer criteria.

(a) *Trainer qualification required.* (1) All classes that provide manufactured home installation education classes used to satisfy the requirements for

the initial issuance and renewal of installation licenses under subpart C of this part must be taught by trainers who are registered with HUD as qualified trainers. In order to register with HUD as a qualified trainer, a person must meet the experience requirements of this section.

(2) Any entity other than a natural person may also provide initial training and continuing education, as long as such entity establishes its qualification as a trainer by providing evidence and assurance that the entity's individual trainers meet the requirements of this section.

(b) *Experience prerequisites.* In order to qualify as a trainer, an individual or other training entity must provide to HUD evidence that each individual who will be responsible for providing training:

(1) Has a minimum of 3,600 hours of experience in one or more of the following:

(i) As a supervisor of manufactured home installations;

(ii) As a supervisor in the building construction industry;

(iii) In design work related to the building construction industry; or

(2) Has completed a 2-year educational program in a construction-related field.

(c) *Certification of curriculum.* In order to register as a qualified trainer, an individual or other training entity must submit to HUD certification that training provided in accordance with this subpart D will meet the curriculum requirements established in § 3286.308 or § 3286.309, as applicable.

§ 3286.307 Process for obtaining trainer's qualification.

(a) *Where to apply.* An applicant for qualification as a trainer must provide the applicant's legal name, address, and telephone number to HUD. The application, with all required information, must be sent to: Administrator, Office of Manufactured Housing Programs, HUD, 451 Seventh Street, SW., Room 9164, Washington DC 20410-8000, or to a fax number or e-mail address obtained by calling the Office of Manufactured Housing Programs. For convenience only, the URL of the Web site is <http://www.hud.gov/offices/hsg/sfh/mhs/>

§ 3286.308

24 CFR Ch. XX (4-1-11 Edition)

mshome.cfm, and the toll-free telephone number to contact the Office of Manufactured Housing Programs is 1-800-927-2891, extension 57.

(b) *Proof of experience.* (1) Every individual applicant for initial qualification as a trainer must submit verification of the experience required in § 3286.305. This verification may be in the form of statements by past or present employers or a self-certification that the applicant meets those experience requirements, but HUD may contact the applicant for additional verification at any time. The applicant must also provide to HUD employment information relevant to the applicant's experience as a trainer, including the dates and type of such employment. A trainer who is licensed, or otherwise certified, to provide manufactured home installation training in a state with a qualifying installation program may seek an exemption from the experience requirement by submitting proof of such license or other certification. An individual who applies for renewal qualification as a trainer is not required to submit additional proof of experience.

(2) An entity that seeks to be designated as a qualified trainer must provide evidence and assurance that the entity's individual trainers meet the experience requirements in § 3286.305.

(c) *Other qualification information.* (1) An applicant for initial or renewal qualification as a trainer must submit to HUD a list of all states in which the applicant has had a similar training qualification revoked, suspended, or denied.

(2) An applicant also must submit to HUD a certification that training provided in accordance with this subpart D will meet the curriculum requirements established in § 3286.308 or § 3286.309, as applicable.

(d) *Confirmation or denial of qualification.* (1) When HUD confirms that an applicant has met the experience and curriculum requirements in this section, HUD will either:

(i) Provide to the applicant a written confirmation that the applicant is a qualified trainer under this part, and will add the applicant's name to a list maintained by HUD of qualified trainers; or

(ii) Provide a written explanation of why HUD deems the applicant to not qualify as a trainer, including on grounds applicable under § 3286.311 for suspension or revocation of a qualification and any other specified evidence of inability to meet the requirements of this part.

(2) An applicant whose qualification is denied by HUD may request an opportunity for a presentation of views, in accordance with subpart D of part 3282 of this chapter, for the purpose of establishing the applicant's qualifications to be a qualified trainer or the adequacy of any training curriculum that is challenged by HUD.

(e) *Assignment of qualification prohibited.* A qualification issued under this subpart D may not be transferred, assigned, or pledged to another entity or individual.

§ 3286.308 Training curriculum.

(a) *Curriculum for initial installer licensing.* The training provided by qualified trainers to installers to meet the initial requirements of the HUD-administered installation program must include at least 12 hours of training, at least 4 hours of which must consist of training on the federal installation standards in part 3285 of this chapter and the installation program regulations in this part. The curriculum must include, at a minimum, training in the following areas:

(1) An overview of the Act and the general regulatory structure of the HUD manufactured housing program;

(2) An overview of the manufactured home installation standards and regulations established in parts 3285 and 3286 of this chapter, and specific instruction including:

- (i) Preinstallation considerations;
- (ii) Site preparation;
- (iii) Foundations;
- (iv) Anchorage against wind;
- (v) Optional features, including comfort cooling systems;
- (vi) Ductwork and plumbing and fuel supply systems;
- (vii) Electrical systems; and
- (viii) Exterior and interior close-up work;

(3) An overview of the construction and safety standards and regulations

found in parts 3280 and 3282 of this chapter;

(4) Licensing requirements applicable to installers;

(5) Installer responsibilities for correction of improper installation, including installer obligations under applicable state and HUD manufactured housing dispute resolution programs;

(6) Inspection requirements and procedures;

(7) Problem-reporting mechanisms;

(8) Operational checks and adjustments; and

(9) Penalties for any person's failure to comply with the requirements of this part 3286 and parts 3285 and 3288 of this chapter.

(b) *Updating curriculum.* Qualified trainers must revise and modify course curriculum as needed to include, at a minimum, any relevant modifications to the Act or the implementing standards and regulations in this chapter, as well as to provide any training further mandated by HUD.

§ 3286.309 Continuing education-trainers and curriculum.

(a) *HUD-mandated elements.* Only qualified trainers are permitted to provide any training on particular subject areas that are required by HUD to be an element of the continuing education requirement set out in § 3286.205(b)(2) for the renewal of an installer's license. In implementing this requirement, HUD will:

(1) Establish the minimum number of hours and the required curriculum for such subject areas, according to experience with the program and changes in program requirements; and

(2) Provide information about the hours and curriculum directly to qualified trainers and licensed installers, or through general publication of the information.

(b) *Other training.* (1) The remainder of the 8 hours required to meet the continuing education requirement may be met through training provided either by qualified trainers or by any combination of the following:

(i) Accredited educational institutions, including community colleges and universities;

(ii) A provider of continuing education units who is certified by the

International Association for Continuing Education and Training;

(iii) Agencies at any level of government; and

(iv) State or national professional associations.

(2) The curriculum for the remainder of the 8 hours of continuing education training must relate to any aspect of manufactured home installation or construction, or to the general fields of building construction or contracting.

§ 3286.311 Suspension or revocation of trainer's qualification.

(a) *Oversight.* The Secretary may make a continuing evaluation of the manner in which each qualified trainer is carrying out the trainer's responsibilities under this subpart D.

(b) *Suspension or revocation of qualification.* After notice and an opportunity for a presentation of views in accordance with subpart D of part 3282 of this chapter, the Secretary may suspend or revoke a trainer's qualification under this part. A trainer's qualification may be suspended or revoked for cause, which may include:

(1) Providing false records or information to HUD;

(2) Refusing to submit information required to be submitted by the Secretary in accordance with the Act;

(3) Certifying, or improperly assisting certification of, a person as having met the training requirements established in this part when that person has not completed the required training;

(4) Failing to appropriately supervise installation training that is used to meet the requirements of this part and that is provided by other persons; and

(5) Any other failures to comply with the requirements of this part.

(c) *Other criteria.* In deciding whether to suspend or revoke a trainer's qualification, the Secretary will consider the impact of the suspension or revocation on other affected parties and will seek to assure that the sales and siting of manufactured homes are not unduly disrupted.

(d) *Reinstating qualification.* A trainer whose qualification has been suspended or revoked may submit a new application to be qualified in accordance with this subpart D no sooner than 6 months

§ 3286.313

after the date of suspension or revocation. A trainer whose qualification has been suspended may also reinstate the qualification in any manner provided under the terms of the suspension.

§ 3286.313 Expiration and renewal of trainer qualification.

(a) *Expiration.* Each notice of qualification issued or renewed under this subpart D will expire 5 years after the date of its issuance or renewal.

(b) *Renewal.* An application for the renewal of a trainer qualification must be submitted to HUD in accordance with § 3286.307, and must be submitted at least 60 days before the date the trainer's term of qualification expires. Any person applying for a qualification renewal after the date the qualification expires must apply for a new qualification, following the requirements established under this subpart D for application for initial qualification as an installation trainer.

Subpart E—Installer Responsibilities of Installation in HUD-Administered States

§ 3286.401 Purpose.

The purpose of this subpart E is to set out the responsibilities of the installer who is accountable for the installation of a manufactured home in compliance with the requirements of the HUD-administered installation program.

§ 3286.403 Licensing requirements.

An installer of manufactured homes must comply with the licensing requirements set forth in subpart C of this part.

§ 3286.405 Installation suitability.

(a) *Site appropriateness.* Before installing a manufactured home at any site, the installer must assure that the site is suitable for installing the home by verifying that:

- (1) The site is accessible;
- (2) The site is appropriate for the foundation or support and stabilization system that is to be used to install the home in accordance with the federal installation standards or alternative

24 CFR Ch. XX (4–1–11 Edition)

requirements in part 3285 of this chapter;

(3) The data plate required by § 3280.5 of this chapter is affixed to the home, that the home is designed for the roof load, wind load, and thermal zones that are applicable to the intended site; and

(4) The installation site is protected from surface run-off and can be graded in accordance with part 3285.

(b) *Installer notification of unsuitable site.* If the installer determines that the home cannot be installed properly at the site, the installer must:

(1) Notify the purchaser or other person with whom the installer contracted for the installation work, identifying the reasons why the site is unsuitable;

(2) Notify the retailer that contracted with the purchaser for the sale of the home, identifying the reasons why the site is unsuitable;

(3) Notify HUD, identifying the reasons why the site is unsuitable;

(4) Decline to install the home until the site and the home are both verified by the installer as suitable for the site under this section; and

(5) Ensure that all unique characteristics of the site have been fully addressed.

(c) *Installer notification of failures to comply with the construction and safety standards.* If the installer notices and recognizes failures to comply with the construction and safety standards in part 3280 of this chapter prior to beginning any installation work, during the course of the installation work, or after the installation work is complete, the installer must notify the manufacturer and retailer of each failure to comply.

(d) *Retailer notification.* The retailer must provide a copy of the notification received in paragraphs (b) and (c) of this section to any subsequent installer.

§ 3286.407 Supervising work of crew.

The installer will be responsible for the work performed by each person engaged to perform installation tasks on a manufactured home, in accordance with the HUD-administered installation program.

§ 3286.409 Obtaining inspection.

(a) *Inspection obligations.* Ten business days prior to the completion of installation, the installer must arrange for a third-party inspection of the work performed, in accordance with subpart F of this part, unless the installer and retailer who contracted with the purchaser for the sale of the home agree, in writing, that during the same time period the retailer will arrange for the inspection. Such inspection must be performed as soon as practicable by an inspector who meets the qualifications set forth in § 3286.511. The scope of the inspections that are required to be performed is addressed in § 3286.505.

(b) *Contract rights not affected.* Failure to arrange for an inspection of a home within 5 business days will not affect the validity or enforceability of any sale or contract for the sale of any manufactured home.

(c) *State or local permits.* The licensed installer should obtain all necessary permits required under state or local laws.

§ 3286.411 Certifying installation.

(a) *Certification required.* When the installation work is complete, a licensed installer must visit the jobsite and certify that:

(1) The manufactured home has been installed in accordance with:

(i) An installation design and instructions that have been provided by the manufacturer and approved by the Secretary directly or through review by the DAPIA; or

(ii) An installation design and instructions that have been prepared and certified by a professional engineer or registered architect, that have been approved by the manufacturer and the DAPIA as providing a level of protection for residents of the home that equals or exceeds the protection provided by the federal installation standards in part 3285 of this chapter.

(2) The installation of the home has been inspected as required by § 3286.503, and an inspector has verified the installation as meeting the requirements of this part.

(3) All installation defects brought to the installer's attention have been corrected.

(b) *Recipients of certification.* The installer must provide a signed copy of its certification to the retailer that contracted with the purchaser or lessee for the sale or lease of the home, and to the purchaser or other person with whom the installer contracted for the installation work.

§ 3286.413 Recordkeeping.

(a) *Records to be retained.* The installer must retain:

(1) A record of the name and address of the purchaser or other person with whom the installer contracted for the installation work and the address of the home installed;

(2) A copy of the contract pursuant to which the installer performed the installation work;

(3) A copy of any notice from an inspector disapproving the installation work;

(4) A copy of the qualified inspector's verification of the installation work;

(5) A copy of the installer's certification of completion of installation in accordance with the requirements of this part; and

(6) A copy of foundation designs used to install the home, if different from the designs provided by the manufacturer, including evidence that the foundation designs and instructions were certified by a professional engineer or registered architect, including the name, address, and telephone number of the professional engineer or architect certifying the designs.

(b) *Retention requirement.* The records listed in paragraph (a) of this section must be maintained for a period of 3 years after the installer certifies completion of installation.

Subpart F—Inspection of Installations in HUD-Administered States**§ 3286.501 Purpose.**

The purpose of this subpart F is to provide additional detail about the inspection that must be performed by a qualified third-party inspector before the installation of a manufactured home may be verified by the inspector and certified by the installer under the HUD-administered installation program.

§ 3286.503

24 CFR Ch. XX (4–1–11 Edition)

§ 3286.503 Inspection required.

(a) *Timing of requirements.* Ten business days prior to the completion of the installation of each manufactured home, the installer must arrange for a third-party inspection of the work performed, unless the installer and retailer who contracted with the purchaser for the sale of the home agree, in writing, that during the same time period the retailer will arrange for the inspection. Such inspection must be performed as soon as practicable by an inspector that meets the qualifications set out in § 3286.511. The scope of the inspections that are required to be performed is addressed in § 3286.505.

(b) *Disclosure of requirement.* At the time of sale, the retailer must disclose to the purchaser, in a manner provided in § 3286.7, that the manufactured home must be installed in accordance with applicable federal and state law, including requirements for a third-party inspection of the installation. If the cost of inspection of the home's installation is not included in the sales price of the home, the sales contract must include a clear disclosure about whether the purchaser will be charged separately for the inspection of the home's installation and the amount of such charge.

(c) *Providing instructions to inspectors.* Installation instructions must be made available to the inspector at the installation site by the installer.

§ 3286.505 Minimum elements to be inspected.

The installation of every manufactured home that is subject to the HUD-administered installation program is required to be inspected for each of the installation elements included in a checklist. The checklist must include assurance that each of the following elements complies with the requirements of part 3285 of this chapter:

- (a) Site location with respect to home design and construction;
- (b) Consideration of site-specific conditions;
- (c) Site preparation and grading for drainage;
- (d) Foundation construction;
- (e) Anchorage;
- (f) Installation of optional features;

- (g) Completion of ductwork, plumbing, and fuel supply systems;
- (h) Electrical systems;
- (i) Exterior and interior close-up;
- (j) Skirting, if installed; and
- (k) Completion of operational checks and adjustments.

§ 3286.507 Verifying installation.

(a) *Verification by inspector.* When an inspector is satisfied that the manufactured home has been installed in accordance with the requirements of this part, the inspector must provide verification of the installation in writing and return the evidence of such verification to the installer.

(b) *Certification by installer.* (1) Once an installation has been inspected and verified, the installer is permitted to certify the installation as provided in § 3286.111. The installer must provide a signed copy of the certification to:

- (i) The retailer that contracted with the purchaser for the sale of the home;
- (ii) The purchaser; and
- (iii) Any other person that contracted to obtain the services of the installer for the installation work on the home.

(2) The installer must retain records in accordance with § 3286.413.

§ 3286.509 Reinspection upon failure to pass.

(a) *Procedures for failed inspection.* If the inspector cannot verify the installation of the manufactured home, the inspector must immediately notify the installer of any failures to comply with the installation standards and explain the reasons why the inspector cannot issue verification that the installation complies with the requirements of this part. After the installation is corrected, it must be reinspected before verification can be issued.

(b) *Cost of reinspection.* If there is any cost for the reinspection of an installation that an inspector has refused to verify, that cost must be paid by the installer or the retailer and, absent a written agreement with the purchaser that specifically states otherwise, that cost cannot be charged to the purchaser of the manufactured home.

§ 3286.511 Inspector qualifications.

(a) *Qualifications.* Any individual or entity who meets at least one of the following qualifications is permitted to review the work and verify the installation of a manufactured home that is subject to the requirements of the HUD-administered installation program:

(1) A manufactured home or residential building inspector employed by the local authority having jurisdiction over the site of the home, provided that the jurisdiction has a residential code enforcement program;

(2) A professional engineer;

(3) A registered architect;

(4) A HUD-accepted Production Inspection Primary Inspection Agency (PIIA) or a Design Approval Primary Inspection Agency (DAPIA); or

(5) An International Code Council certified inspector.

(b) *Independence required.* The inspector must be independent of the manufacturer, the retailer, the installer, and any other person that has a monetary interest, other than collection of an inspection fee, in the completion of the sale of the home to the purchaser.

(c) *Suspension or revocation of inspection authority.* After notice and an opportunity for a presentation of views in accordance with subpart D of part 3282 of this chapter, the Secretary may suspend or revoke an inspector's authority to inspect manufactured home installations under this part in HUD-administered states. An inspector's authority may be suspended or revoked for cause. In deciding whether to suspend or revoke an inspector's authority to conduct such installation inspections, the Secretary will consider the impact of the suspension or revocation on other affected parties and will seek to assure that the sales and siting of manufactured homes are not unduly disrupted.

(d) *Reinstating inspection authority.* An inspector whose authority to inspect manufactured home installations in HUD-administered states has been suspended or revoked under this section may apply for reauthorization by contacting: Administrator, Office of Manufactured Housing Programs, HUD, 451 Seventh Street, SW., Room 9164, Washington, DC 20410-8000, or to a fax number or e-mail address obtained by call-

ing the Office of Manufactured Housing Programs at the toll-free telephone number 1-800-927-2891, extension 57.

Subpart G—Retailer Responsibilities in HUD-Administered States**§ 3286.601 Purpose.**

The purpose of this subpart G is to set out the requirements that apply to a retailer with respect to the federal installation requirements applicable to new manufactured homes that the retailer sells or leases and that will be installed in states that do not have qualifying installation programs. These requirements are in addition to other requirements that apply to retailers of manufactured homes pursuant to other parts of this chapter.

§ 3286.603 At or before sale.

(a) *Before contract.* (1) The retailer is required to support each transportable section of a manufactured home that is temporarily or permanently located on a site used by a retailer in accordance with the manufacturer's instructions.

(2) Before a purchaser or lessee signs a contract of sale or lease for a manufactured home, the retailer must:

(i) Provide the purchaser or lessee with a copy of the consumer disclosure statement required in § 3286.7(b); and

(ii) Verify that the wind, thermal, and roof load zones of the home being purchased or leased are appropriate for the site where the purchaser or lessee plans to install the home for occupancy; and

(iii) If the cost of inspection of the home's installation is not included in the sales price of the home, provide the disclosure required in § 3286.7(b).

(b) *Occupancy site not known.* When at the time of purchase the purchaser does not know the locale for the initial siting of the home for occupancy, the retailer must advise the purchaser that:

(1) The home was designed and constructed for specific wind, thermal, and roof load zones; and

(2) If the home is sited in a different zone, the home may not pass the required installation inspection because the home will have been installed in a

§ 3286.605

manner that would take it out of compliance with the construction and safety standards in part 3280 of this chapter.

(c) *Verification of installer license.* When the retailer or manufacturer agrees to provide any set up in connection with the sale or lease of the home, the retailer or manufacturer must verify that the installer is licensed in accordance with these regulations.

§ 3286.605 After sale.

(a) *Tracking installation information.* The retailer is responsible for providing to HUD the information required pursuant to § 3286.113.

(b) *Other tracking and compliance requirements.* The retailer continues to be responsible for compliance with the tracking and compliance requirements set out in subpart F of part 3282 of this chapter, which are related to HUD construction and safety standards.

§ 3286.607 Recordkeeping.

The retailer is responsible for the reporting and recordkeeping requirements under § 3286.113.

Subpart H—Oversight and Enforcement in HUD-Administered States

§ 3286.701 Purpose.

The purpose of this subpart H is to set out the mechanisms by which manufacturers, retailers, distributors, installers, and installation inspectors will be held accountable for assuring the appropriate installation of manufactured homes. The requirements in subpart A of this part are applicable in all states, the requirements in subparts B through H are applicable in states where the HUD-administered installation program operates, and the requirements in subpart I are applicable in states with qualifying installation programs. It is the policy of the Secretary, regarding manufactured home installation program enforcement matters, to cooperate with state or local agencies having authority to regulate the installation of manufactured homes. In addition to actions expressly recognized under this subpart H and other

24 CFR Ch. XX (4–1–11 Edition)

provisions in this part, however, HUD may take any actions authorized by the Act in order to oversee the system established by the regulations in this part.

§ 3286.703 Failure to comply.

(a) *Penalties and injunctive relief.* Failure to comply with the requirements of this part is a prohibited act under section 610(a)(7) of the Act, 42 U.S.C. 5409(a). Any person who fails to comply with the requirements of this part is subject to civil and criminal penalties, and to actions for injunctive relief, in accordance with sections 611 and 612 of the Act, 42 U.S.C. 5410 and 5411.

(b) *Presentation of views.* When practicable, the Secretary will provide notice to any person against whom an action for injunctive relief is contemplated and will afford such person an opportunity to request a presentation of views. The procedures set forth in §§ 3282.152 through 3282.154 of this chapter shall apply to each request to present views and to each presentation of views authorized in accordance with this section.

(c) *Investigations.* The procedures for investigations and investigational proceedings are set forth in part 3800 of this chapter.

§ 3286.705 Applicability of dispute resolution program.

(a) *Generally.* Regardless of any action taken under § 3286.703, for any defect in a manufactured home that is reported during the one-year period beginning on the date of installation, as specified in § 3286.115, any rights and remedies available under the HUD dispute resolution program, as implemented in part 3288 of this chapter, continue to apply as provided in that part.

(b) *Waiver of rights invalid.* Any provision of a contract or agreement entered into by a manufactured home purchaser that seeks to waive any recourse to either HUD or a state dispute resolution program is void.

Subpart I—State Programs

§ 3286.801 Purpose.

The purpose of this subpart I is to establish the requirements that must be

met by a state to implement and administer its own installation program, either as part of its approved state plan or under this subpart, in such a way that the state would not be covered by the HUD-administered installation program. This subpart I also establishes the procedure for determining whether a state installation program meets the requirements of the Act for a qualifying installation program that will operate in lieu of the HUD-administered installation program.

§ 3286.803 State qualifying installation programs.

(a) *Qualifying installation program supersedes.* The HUD-administered installation program will not be implemented in any state that is identified as fully or conditionally accepted under the requirements and procedures of this subpart I or in accordance with part 3282 of this chapter.

(b) *Minimum elements.* To be accepted as a fully qualifying installation program, a state installation program must include the following elements:

(1) Installation standards that meet or exceed the requirements of § 3286.107(a) and that apply to every initial installation of a new manufactured home within the state;

(2) The training of manufactured home installers;

(3) The licensing of, or other method of certifying or approving, manufactured home installers to perform the initial installations of new manufactured homes in the state;

(4) A method for inspecting the initial installations of new manufactured homes in the state that is implemented and used to hold installers responsible for the work they perform; and

(5) Provision of adequate funding and personnel to administer the state installation program.

(c) *Conditional acceptance.* (1) A state installation program that meets the minimum requirements set forth under paragraphs (b)(1), (4), and (5) of this section may be conditionally accepted by the Secretary if the state provides assurances deemed adequate by the Secretary that the state is moving to meet all of the requirements for full acceptance. If the Secretary conditionally accepts a state's installation

program, the Secretary will provide to the state an explanation of what is necessary to obtain full acceptance.

(2) A conditionally accepted state will be permitted to implement its own installation program in lieu of the HUD-administered program for a period of not more than 3 years. The Secretary may for good cause grant an extension of conditional approval upon petition by the state.

(d) *Limited exemptions from requirements.* A state installation program may be accepted by the Secretary as a qualifying installation program if the state can demonstrate that it lacks legal authority, as a matter of federal law, to impose the minimum requirements set forth under paragraph (b) of this section in certain geographic areas of the state, but that the minimum requirements do apply in all other geographic areas of the state.

§ 3286.805 Procedures for identification as qualified installation program.

(a) *Submission of certification.* (1) A state seeking identification as having a qualified installation program must submit a completed State Installation Program Certification form to the Secretary for review and acceptance and indicate if the installation program will be part of its approved state plan in accordance with part 3282 of this chapter.

(2) A state must include a qualified installation program as part of any state plan application submitted for approval under § 3282.302 of this chapter, if the state does not have a fully or conditionally approved state plan in effect at the time of submission of the state plan application. In all other cases, a qualified installation program is permitted, but is not required, to be submitted as a part of a state plan approved in accordance with § 3282.305 of this chapter.

(b) *HUD review and action.* (1) The Secretary will review the State Installation Program Certification form submitted by a state and may request that the state submit additional information as necessary. Unless the Secretary has contacted the state for additional

information or has conditionally accepted or rejected the state installation program, the state installation program will be considered to have been accepted by the Secretary as a fully qualifying installation program as of the earlier of:

(i) Ninety days after the Secretary receives the state's completed State Installation Program Certification form; or

(ii) The date that the Secretary issues notification to the state of its full acceptance.

(2) A notice of full or conditional acceptance will include the effective date of acceptance.

(c) *Rejection of state installation program.* (1) If the Secretary intends to reject a state's installation program, the Secretary will provide to the state an explanation of what is necessary to obtain full or conditional acceptance. The state will be given 90 days from the date the Secretary provides such explanation to submit a revised State Installation Program Certification form.

(2) If the Secretary decides that any revised State Installation Program Certification form is inadequate, or if the state fails to submit a revised form within the 90-day period or otherwise indicates that it does not intend to change its form, the Secretary will notify the state that its installation program is not accepted.

(3) A state whose State Installation Program Certification form is rejected has a right to a presentation of views on the rejection using the procedures set forth under subpart D of part 3282 of this chapter. The state's request for a presentation of views must be submitted to the Secretary within 60 days after the Secretary has provided notification that the state's installation program has been rejected.

§ 3286.807 Recertification required.

(a) *Recertification.* To maintain its status as a qualified installation program when the installation program is not part of the approved state plan in accordance with part 3282 of this chapter, a state must submit a new State Installation Program Certification form to the Secretary for review and action as follows:

(1) Every 5 years after the state's most recent certification as a qualified installation program; and

(2) Whenever there is a change to the state's installation program or a change in the HUD requirements applicable to qualifying installation programs such that the state's installation program no longer complies with the minimum requirements set forth in § 3286.803(b), regardless of when the state's next regular recertification of its installation program would be due.

(b) *Due date of recertification.* (1) A state's recertification required in paragraph (a) of this section must be filed within 90 days of, as applicable:

(i) The 5-year anniversary of the effective date of the Secretary's acceptance of the state's most recent certification as a qualified installation program; and

(ii) The effective date of the state or HUD action that makes a significant change to the state's installation program.

(2) Upon petition by the state, the Secretary may for good cause grant an extension of the deadline for recertification.

(c) *Failure to Recertify.* (1) A state whose certification of its installation program, when the installation program is not part of the approved state plan in accordance with part 3282 of this chapter, has been accepted by the Secretary is permitted to administer its installation program in lieu of the HUD-administered installation program until the effective date of a notification by the Secretary that the state's certification of its installation program is no longer approved.

(2) A state whose recertification of its installation program is rejected by the Secretary has a right to a presentation of views on the rejection using the procedures set forth under subpart D of part 3282 of this chapter. The state's request for a presentation of views must be submitted to the Secretary within 60 days after the Secretary has provided notification that the state's recertification of its installation program has been rejected.

§ 3286.809 Withdrawal of qualifying installation program status.

(a) *Voluntary withdrawal.* Any state that intends to withdraw from its responsibilities to administer a qualifying installation program should provide the Secretary with a minimum of 90 days notice.

(b) *Involuntary withdrawal.* Whenever the Secretary finds, after affording notice and an opportunity for a hearing in accordance with subpart D of part 3282 of this chapter, that a state installation program fails to comply substantially with any provision of the installation program requirements or that the state program has become inadequate, the Secretary will notify the state of withdrawal of acceptance or conditional acceptance of the state installation program. The HUD-administered installation program will begin to operate in such state at such time as the Secretary establishes in issuing the finding.

§ 3286.811 Effect on other manufactured housing program requirements.

A state with a qualifying installation program will operate in lieu of HUD with respect to only the installation program established under subparts B through H of this part. No state may permit its installation program, even if it is a qualified installation program under this part, to supersede the requirements applicable to HUD's Manufactured Housing Construction and Safety Standards and enforcement programs. Regardless of whether a state has a qualified installation program:

(a) *Construction and safety standards.* Any responsibilities, rights, and remedies applicable under the Manufactured Home Construction and Safety Standards Act in part 3280 of this chapter and the Manufactured Home Procedural and Enforcement Regulations in part 3282 of this chapter continue to apply as provided in those parts; and

(b) *Dispute resolution.* For any defect in a manufactured home that is reported during the one-year period beginning on the date of installation defined in § 3286.115, any responsibilities, rights, and remedies applicable under the HUD dispute resolution program as implemented in part 3288 of this chap-

ter continue to apply as provided in that part.

§ 3286.813 Inclusion in state plan.

If a state installation program is included in a state plan approved in accordance with § 3282.302 of this chapter, the state installation program is subject to all of the requirements for such a state plan, including annual review by HUD.

PART 3288—MANUFACTURED HOME DISPUTE RESOLUTION PROGRAM**Subpart A—General**

Sec.

3288.1 Purpose and scope.

3288.3 Definitions.

3288.5 Retailer notification at sale.

Subpart B—HUD Manufactured Home Dispute Resolution Program in HUD-Administered States

3288.10 Applicability.

3288.15 Eligibility for dispute resolution.

3288.20 Reporting a defect.

3288.25 Initiation of dispute resolution.

3288.30 Screening of dispute resolution request.

3288.33 Notice of dispute resolution.

3288.35 Mediation.

3288.40 Nonbinding arbitration.

3288.45 HUD review and order.

Subpart C—Alternative Process in HUD-Administered States

3288.100 Scope and applicability.

3288.105 Time when Alternative Process is available.

3288.110 Alternative Process agreements.

Subpart D—State Dispute Resolution Programs in Non-HUD-Administered States

3288.200 Applicability.

3288.205 Minimum requirements.

3288.210 Acceptance and recertification process.

3288.215 Effect on other manufactured home program requirements.

Subpart E—Dispute Resolution Program Rulemaking Procedures

3288.300 Applicability.

3288.305 Consultation with the Manufactured Housing Consensus Committee.

AUTHORITY: 42 U.S.C. 3535(d), 5422 and 5424.

§ 3288.1

24 CFR Ch. XX (4–1–11 Edition)

SOURCE: 72 FR 27229, May 14, 2007, unless otherwise noted.

Subpart A—General

§ 3288.1 Purpose and scope.

(a) *Purpose.* The Act is intended, in part, to protect the quality, safety, durability, and affordability of manufactured homes. Section 623(c)(12) of the Act (42 U.S.C. 5422 (c)(12)) requires the implementation of “a dispute resolution program for the timely resolution of disputes between manufacturers, retailers, and installers of manufactured homes regarding responsibility, and for the issuance of appropriate orders, for the correction or repair of defects in manufactured homes that are reported during the 1-year period beginning on the date of installation.” The purpose of this part is to provide a dispute resolution program for the timely resolution of disputes among manufacturers, retailers, and installers regarding the responsibility for correction or repair of defects reported by the homeowner or others and reported in the 1-year period after the first installation of the manufactured home.

(b) *Scope—(1) Applicability.* In carrying out this purpose, it is presumed that if a manufactured home contains an alleged defect that is reported in the first year after installation and was not caused by the homeowner, then the manufacturer, retailer, or installer is responsible for the alleged defect and the dispute resolution process recognized in this part is an appropriate means for resolving disputes about responsibility for correction and repair of the alleged defect. For purposes of the dispute resolution process recognized in this part, only alleged defects reported in the first year after the first installation are covered by the process. The state where the home is sited determines whether the HUD Manufactured Home Dispute Resolution Program or a state program applies. Subpart A of this part establishes general provisions applicable to HUD’s implementation of a dispute resolution program as required by the Act. Subpart B of this part establishes the HUD Manufactured Home Dispute Resolution Program that HUD will administer in any state that does not establish a program

that complies with the Act and been accepted by HUD as provided in subpart D of this part. Subpart C of this part provides an Alternative Process for manufacturers, retailers, and installers who agree that a homeowner is not responsible for the alleged defect to resolve their disputes about responsibility for correction or repair outside of the HUD Mediation and Arbitration Process under subpart B. Subpart D of this part establishes the minimum requirements that must be met by a state applying to implement its own dispute resolution program that complies with the Act, and the procedure for determining whether the requirements for complying have been met. Subpart E of this part establishes special rulemaking procedures that apply to the issuance of new regulations that implement the dispute resolution requirements set forth in section 623 of the Act (42 U.S.C. 5422).

(2) *Warranties not affected.* This part is not a warranty program and the requirements established in this part do not replace the manufacturer’s or any other warranty program. Such warranty program may have its own requirements.

§ 3288.3 Definitions.

The following definitions apply in this part:

Act means the National Manufactured Housing Construction and Safety Standards Act of 1974, 42 U.S.C. 5401–5426.

Appropriate order means an order issued by HUD or an order that is enforceable under state law.

Date of installation means the date all utilities are connected and the manufactured home is ready for occupancy as established, if applicable, by a certificate of occupancy, except as follows: if the manufactured home has not been sold to the first person purchasing the home in good faith for purposes other than resale by the date the home is ready for occupancy, the date of installation is the date of closing under the purchase agreement or sales contract for the manufactured home.

Day means a calendar day.

Defect means any defect in the performance, construction, components, or material of a manufactured home

that renders the home or any part of the home not fit for the ordinary use for which it was intended, including, but not limited to, a defect in the construction, safety, or installation of the home. For purposes of state certification under § 3288.205, HUD will find it acceptable if the threshold for the state's program is functionally equivalent to this definition.

Dispute resolution provider means a person or entity providing dispute resolution services for HUD.

Homeowner means a person who purchased or leased the manufactured home in good faith for purposes other than resale.

HUD means the U.S. Department of Housing and Urban Development.

Installer means the person who is retained to engage in, or who engages in, the business of directing, supervising, controlling, or correcting the initial installation of a manufactured home.

Manufactured home has the same meaning as the term "manufactured home" as defined in 24 CFR 3280.2.

Manufactured Housing Consensus Committee or MHCC means the consensus committee established pursuant to section 604(a)(3) of the Act, 42 U.S.C. 5403(a)(3).

Party or parties means, individually or collectively, the manufacturer, retailer, or installer of a manufactured home in which a defect has been reported in accordance with § 3288.20.

State Administrative Agency means an agency of a state that has been approved or conditionally approved to carry out the state plan for enforcement of the standards pursuant to section 623 of the Act, 42 U.S.C. 5422.

Timely reporting means the reporting of an alleged defect within 1 year after the date of installation of a manufactured home in accordance with § 3288.20.

Timely resolution means the resolution of disputes among manufacturers, retailers, and installers within 120 days of the time a request for dispute resolution is made, except that if the defect presents an unreasonable risk of injury, death, or significant loss or damage to valuable personal property, the resolution must be within 60 days of the time a request for dispute resolution is made.

§ 3288.5 Retailer notification at sale.

Retailer notice at the time of signing. At the time of signing a contract for sale or lease for a manufactured home, the retailer must provide the purchaser with a retailer notice. This notice may be in a separate document from the sales contract or may be incorporated clearly in a separate section on consumer dispute resolution information at the top of the sales contract. The notice must include the following language:

The U.S. Department of Housing and Urban Development (HUD) Manufactured Home Dispute Resolution Program is available to resolve disputes among manufacturers, retailers, or installers concerning defects in manufactured homes. Many states also have a consumer assistance or dispute resolution program. For additional information about these programs, see sections titled "Dispute Resolution Process" and "Additional Information—HUD Manufactured Home Dispute Resolution Program" in the Consumer Manual required to be provided to the purchaser. These programs are not warranty programs and do not replace the manufacturer's, or any other person's, warranty program.

Subpart B—HUD Manufactured Home Dispute Resolution Program in HUD-Administered States

§ 3288.10 Applicability.

The requirements of the HUD Manufactured Home Dispute Resolution Program established in this subpart B apply in each state that does not establish a state dispute resolution program that complies with the Act and has been accepted by HUD as provided in subpart D of this part.

§ 3288.15 Eligibility for dispute resolution.

(a) *Initiation of actions.* Manufacturers, retailers, and installers of manufactured homes are eligible to initiate and participate in the HUD Manufactured Home Dispute Resolution Program. Homeowners may initiate action under, and be observers to, the HUD Manufactured Home Dispute Resolution Program.

(b) *Eligible disputes.* Only disputes concerning alleged defects that have

been reported to the manufacturer, retailer, installer, HUD, or a State Administrative Agency within 1 year after the date of the first installation of the manufactured home are eligible for resolution through the HUD Manufactured Home Dispute Resolution Program. The eligible dispute includes the defect alleged in a timely report and any related issues.

§ 3288.20 Reporting a defect.

(a) *Making a report.* To preserve the right to request dispute resolution through HUD, alleged defects must be reported to the manufacturer, retailer, installer, HUD, or a State Administrative Agency. An alleged defect may be reported by a homeowner, manufacturer, retailer, or installer.

(b) *Form of report.* It is recommended that alleged defects be reported in writing, including, but not limited to, e-mail, written letter, certified mail, or fax. The existence of an alleged defect may also be reported by telephone.

(c) *Content of report.* No particular form or format is required to report an alleged defect, but any such report must, at a minimum, include a description of the alleged defect, the name of homeowner, and the address of the home.

(d) *Record of report*—(1) *To evidence timeliness.* To establish timely reporting, the report of an alleged defect that is made to the manufacturer, retailer, installer, or a State Administrative Agency of the manufactured home should be done in a manner that will create a dated record of the report that demonstrates that the report was made within 1 year after the date of installation; for example, by certified mail, fax, or email. Persons who report an alleged defect by telephone should make a contemporaneous note of the telephone call, including date, time, the name of the person who received the report, the name of the business contacted, and the telephone number called. If the matter goes to arbitration, the arbitrator and HUD will review whether there is sufficient evidence to believe the report was made on a timely basis.

(2) *Obligation to retain.* Each report of a defect, including logs of telephonic complaints, received by a manufac-

turer, retailer, a State Administrative Agency or installer, must be maintained for 3 years from the date of receipt.

(e) *Reports made to a State Administrative Agency.* Reports of defects in the manufactured home that are made in the first year after its installation can be sent to the appropriate State Administrative Agency. Contact information about a State Administrative Agency is available at <http://www.hud.gov>. Contact the appropriate State Administrative Agency to determine the method for making the report.

(f) *Reports made to HUD.* Reports of alleged defects in the manufactured home that are made in the first year after its installation can be sent to HUD. The report to HUD may be made using any of the following methods:

(1) In writing at: HUD, Office of Regulatory Affairs and Manufactured Housing, Attn: Dispute Resolution, 451 Seventh Street, SW., Washington, DC 20410-8000;

(2) By telephone at: (202) 708-6423 or (800) 927-2891;

(3) By fax at: (202) 708-4213; or

(4) By e-mail at mhs@hud.gov.

(g) *Effect of report.* The reporting of an alleged defect does not initiate the HUD Manufactured Home Dispute Resolution Program, but only establishes whether the requirement of timely reporting in accordance with § 3288.15(b) has been met. The HUD Manufactured Home Dispute Resolution Process is initiated when a request for dispute resolution is submitted to HUD in accordance with § 3288.25.

§ 3288.25 Initiation of dispute resolution.

(a) *Preliminary effort.* HUD strongly encourages the homeowner or party reporting an alleged defect to seek to resolve the dispute directly with any manufacturer, retailer, or installer that the person reporting the defect believes to be responsible before initiating the HUD dispute resolution process.

(b) *Request for dispute resolution.* Any of the parties or the homeowner may initiate the HUD Manufactured Home Dispute Resolution Program at any time after an alleged defect has been

reported, by requesting dispute resolution, as follows:

(1) By mailing, e-mailing, or otherwise delivering a written request for dispute resolution to the dispute resolution provider at the address or e-mail address provided either at <http://www.hud.gov>, or by contacting HUD's Office of Regulatory Affairs and Manufactured Housing at (202) 708-6423 or (800) 927-2891;

(2) By faxing a request for dispute resolution to the fax number provided either at <http://www.hud.gov>, or by contacting HUD's Office of Regulatory Affairs and Manufactured Housing at (202) 708-6423 or (800) 927-2891; or

(3) By telephoning a request for dispute resolution to the number provided either at <http://www.hud.gov>, or by contacting HUD's Office of Regulatory Affairs and Manufactured Housing at (202) 708-6423 or (800) 927-2891.

(c) *Requested information.* The dispute resolution provider will request at least the following information when a person seeks to initiate dispute resolution under the HUD Manufactured Home Dispute Resolution Program:

(1) The name, address, and contact information of the homeowner;

(2) The name and contact information of the manufacturer, retailer, and installer of the manufactured home, to the extent available;

(3) The date the report of the alleged defect was made;

(4) The name and contact information of the recipient or recipients of the report of the alleged defect;

(5) The date of installation of the manufactured home affected by the alleged defect; and

(6) A description of the alleged defect.

§ 3288.30 Screening of dispute resolution request.

(a) *Review for sufficiency.* When the request for dispute resolution has been received by the dispute resolution provider, a screening neutral will review the sufficiency of the information provided in the request for dispute resolution and determine if the dispute resolution process should proceed. If the screening neutral determines that a defect is properly alleged and timely reported, notice of the request will be

forwarded, as provided in § 3288.33, to the manufacturer, retailer, and installer, as appropriate and to the extent the appropriate parties can be identified based on the information in the request.

(b) *Insufficient information.* If a request for dispute resolution is lacking any information necessary to determine if the dispute resolution process should proceed, the screening neutral will contact the requester or the parties about supplementing the initial request. If information necessary to qualify the matter for the HUD Manufactured Home Dispute Resolution Program is not received within a reasonable time established by the screening neutral, the request for dispute resolution will be considered withdrawn.

(c) *Denial of a dispute.* Denial by all of the parties that there is a dispute does not preclude the dispute resolution process from going forward to mediation. A screening neutral's determination that a defect is properly alleged is prima facie evidence of a dispute. If the defect has not been corrected or repaired, the matter will be referred to mediation.

(d) *Determination of unreasonable risk.* If the screening neutral determines there is sufficient documentation of an alleged defect presenting an unreasonable risk of injury or death, he or she will send a copy of the request to HUD.

§ 3288.33 Notice of dispute resolution.

(a) Once the screening neutral determines that a defect is properly alleged and timely reported, notice about the request will be forwarded to the parties by overnight delivery, commercial carrier, or fax.

(b) If the parties have not initiated the Alternative Process in accordance with § 3288.105 of this part within 7 days of the screening neutral's notification, the screening neutral will refer the matter to mediation.

§ 3288.35 Mediation.

(a) *Mediator.* The dispute resolution provider will provide for the selection of a mediator. The selected mediator will not be the person who screened the

§ 3288.40

24 CFR Ch. XX (4–1–11 Edition)

dispute resolution request. The selected mediator will mediate the dispute and attempt to facilitate a settlement. If a party identifies any other party that should be included in the mediation, the mediator will contact the other party and provide information about the scheduled mediation meetings.

(b) *Time*—(1) *For reaching settlement.* Except as provided in paragraph (b)(2) of this section, the parties are allowed 30 days from the commencement of the mediation to reach a mediated settlement. In every case, the dispute resolution provider will notify the parties and the homeowner, in writing, of the date of the commencement of the mediation.

(2) *Alleged defects presenting an unreasonable risk of injury, death, or significant loss or damage to valuable personal property.* For mediations involving alleged defects that appear to present an unreasonable risk of injury, death, or significant loss or damage to valuable personal property as determined by the screening neutral, the parties have a maximum 10 days from the commencement of the mediation to reach a settlement.

(3) *For corrective repairs.* Unless a longer period is agreed to in writing by the parties to the mediated settlement and the homeowner, corrective repairs must be completed no later than 30 days after the date the settlement agreement is signed by the applicable parties.

(c) *Denial of dispute.* During mediation, denial of a dispute by all parties without acceptance of responsibility will result in the mediator referring the matter to arbitration for determination of the defect and responsibility for the defect.

(d) *Written settlement agreement.*

(1) Upon reaching an agreement, the parties will sign a written settlement agreement. The dispute resolution provider will forward copies of the agreements with the original signatures of the parties to the parties, the homeowner, and to HUD.

(2) Sample agreements will be made available to the parties as drafting guidance by the dispute resolution provider.

(e) *Failure of mediation.* If mediation is not successful, parties or the homeowner may proceed to nonbinding arbitration, as provided in §3288.40 of this part.

(f) *Confidentiality.* Except for the report of an alleged defect, any request for dispute resolution, and any written settlement agreement, all other documents and communications provided in confidence and used in the mediation will be confidential, in accordance with the Administrative Dispute Resolution Act of 1996 (5 U.S.C. 571 *et seq.*).

§ 3288.40 Nonbinding arbitration.

(a) *When initiated.* (1) If, following mediation under §3288.35, the parties fail to reach a settlement, any party or the homeowner may, within 15 days of the expiration of the deadline applicable under §3288.35(b), initiate nonbinding arbitration.

(2) In addition, arbitration may be initiated upon referral by the mediator pursuant to §3288.35(c).

(b) *Written request*—(1) *Submission to HUD.* A written request for arbitration must be submitted to the dispute resolution provider and how to make a request for dispute resolution will be available at <http://www.hud.gov> or by contacting HUD's Office of Manufactured Housing Programs at (202) 708-6423 or (800) 927-2891.

(2) *Contents of request.* The written request for arbitration must include:

- (i) The name and address of the party making the request;
- (ii) A brief description of the alleged defect or a copy of the report of the alleged defect; and
- (iii) A copy of the request for dispute resolution.

(c) *Appointment and authority of arbitrator.* Upon receipt of the request, the dispute resolution provider will select an arbitrator. The arbitrator will have the authority to:

- (1) Set hearing dates and deadlines;
- (2) Conduct on-site inspections;
- (3) Issue requests for documentation and information necessary to complete the record;
- (4) Dismiss frivolous allegations;
- (5) Make proposed findings, including findings of defect and culpability and a

disposition recommendation to HUD; and

(6) Recommend apportionment of the responsibility of paying for or providing any correction or repair of the home when recommending that culpability be assessed to more than one party.

(d) *Denial of dispute.* If the parties deny a dispute exists and the arbitrator determines there is a defect, the arbitrator will make a determination of responsibility for the defect.

(e) *Notice to parties.* The dispute resolution provider will provide the parties and the homeowner with a notice setting forth the date, place, and time an arbitration is to be held.

(f) *Proceedings.* (1) If all parties do not request an in-person hearing under paragraph (f)(2) of this section within 5 days of the dispute resolution provider's receipt of the request for arbitration, or if the arbitrator rejects the request for an in-person hearing, the arbitrator may conduct either a record review or a telephonic hearing.

(2) If any party wants to request an in-person hearing, in which the parties or their representatives may personally appear before the arbitrator, the arbitrator will consider such a request if it is made by all of the parties that are participating in the arbitration. Such an in-person hearing will be held at the discretion of the arbitrator, after considering appropriate factors, such as cost.

(g) *Effect on nonparticipating parties.* If a party chooses not to participate in the arbitration, the process will continue without further input from that party. In such a case, the arbitrator may rely on the record developed through the arbitration to find a nonparticipating party responsible for correction or repair of a defect.

(h) *Completion of arbitration.* (1) Unless an extension is granted for good cause by HUD, the arbitrator, within 21 days of the dispute resolution provider's receipt of the request for arbitration, the arbitrator will complete the arbitration process and provide HUD with all background information used during the arbitration and with a written, nonbinding recommendation as to which party or parties are respon-

sible for the defect, and what corrective actions should be taken.

(2) Unless an extension is granted for good cause by HUD, the arbitrator, within 21 days of the dispute resolution provider's receipt of the request for arbitration, will provide the parties with a copy of the nonbinding recommendation that was delivered to HUD, in accordance with § 3288.40(h)(1).

(i) *Settlement offers.* At any time before HUD issues a final order, the parties may submit to HUD a proposal to resolve the dispute.

§ 3288.45 HUD review and order.

(a) *Appropriate order.* HUD will review the arbitrator's recommendation provided in accordance with § 3288.40(h), any settlement offers presented by the parties in accordance with § 3288.40(i), and the information gathered during the arbitration, and will issue an appropriate order in which HUD may accept, modify, or reject the recommendations. HUD will forward a copy of the order to the arbitrator and to each of the parties and the homeowner, whether or not a party chose to participate in the arbitration.

(b) *Contents of order.* If HUD finds that a defect exists, the order will include the following:

(1) Assignment of responsibility for the correction and repair of all defects and associated costs; and

(2) If the manufacturer, retailer, or installer is responsible for corrective action, a date by which the correction and repair of each defect must be completed, taking into consideration the seriousness of the defect.

(c) *Failure to comply.* Failure to comply with an order issued by HUD is a violation of section 610(a)(5) of the Act (42 U.S.C. 5409(a)(5)).

Subpart C—Alternative Process in HUD-Administered States

§ 3288.100 Scope and applicability.

The requirements of this subpart C may be followed in lieu of the requirements of subpart B of this part to resolve disputes among manufacturers, retailers, and installers of manufactured homes in any state where subpart B of this part would otherwise apply. In limited circumstances, this

§ 3288.105

subpart C permits manufacturers, retailers, and installers of manufactured homes to use neutrals of their choosing to resolve disputes concerning alleged defects in manufactured homes.

§ 3288.105 Time when Alternative Process is available.

(a) The Alternative Process may be invoked after an alleged defect has been reported, pursuant to § 3288.15(b). However, the Alternative Process may not be invoked more than 7 days after notification of a request for dispute resolution has been received by all of the parties. The notification must be delivered by overnight delivery, commercial carrier, or fax by the screening neutral, in accordance with § 3288.30. If within 7 days of the receipt of notification, the Alternative Process is not initiated, the screening neutral will refer the matter to the mediator. Once the Alternative Process is invoked, neither the parties nor the homeowner may invoke the Mediation and Arbitration Process in the HUD Manufactured Home Dispute Resolution Program for 30 days.

(b) No particular form or format is required to provide notification for the Alternative Process, but the party or parties submitting the notification must include a statement from the parties participating in the Alternative Process stating that the homeowner is not responsible for the alleged defect and that one or more of the parties will correct or repair the defect. All required agreements are set forth in § 3288.110 of this part. The parties must also make reasonable efforts to include the following information in the notification:

- (1) Identification of the case; and
- (2) Identification of the parties participating in the Alternative Process.

(c) The screening neutral will notify the parties if the case is referred to the Alternative Process for resolution.

§ 3288.110 Alternative Process agreements.

(a) *Required agreement.* To use the Alternative Process, the manufacturer, retailer, and installer of the manufactured home at issue, as appropriate, must agree:

24 CFR Ch. XX (4–1–11 Edition)

(1) That there is a defect in the manufactured home;

(2) That the manufacturer, retailer, or installer is responsible for the defect;

(3) That the homeowner is not responsible for the defect;

(4) To engage a neutral to evaluate the dispute and make an assignment of responsibility for correction and repair; and

(5) To notify the homeowner of, and allow the homeowner to be present at, any meetings and to inform the homeowner of the outcome.

(b) *Additional element of agreement.* In addition, the parties should agree to act upon the neutral's assignment of responsibility for correction and repair.

Subpart D—State Dispute Resolution Programs in Non-HUD Administered States

§ 3288.200 Applicability.

This subpart D establishes the minimum requirements that must be met by a state to implement its own dispute resolution program and therefore not be covered by the HUD Manufactured Home Dispute Resolution Program established in accordance with subpart B. The subpart also establishes the procedure for determining whether the state dispute resolution program meets the requirements of the Act for operating in lieu of the HUD Manufactured Home Dispute Resolution Program.

§ 3288.205 Minimum requirements.

(a) *List of requirements.* The HUD Manufactured Home Dispute Resolution Program will not be implemented in any state that complies with the procedures of this subpart D and that has a dispute resolution program that provides for the following minimum requirements:

(1) The timely resolution of disputes among manufacturers, retailers, or installers regarding responsibility for correction and repair of defects in manufactured homes;

(2) The issuance of appropriate orders for correction and repair of defects in such homes;

(3) A coverage period for disputes that includes at least defects that are reported within 1 year after the date of first installation; and

(4) Adequate funding and personnel.

(b) *Applicability to programs in state plans.* (1) In order to include a dispute resolution program in a state plan that on February 8, 2008 is fully or conditionally approved under § 3282.302 of this chapter, a state must amend its state plan to provide for the requirements of paragraphs (a)(1) through (3) of this section.

(2) After February 8, 2008, a state that submits a state plan for approval in accordance with § 3282.302 of this chapter must provide for the requirements of paragraphs (a)(1) through (3) of this section in its state plan.

§ 3288.210 Acceptance and recertification process.

(a) *Submission of certification.* A state seeking HUD acceptance of its state dispute resolution program under this subpart must submit to HUD a completed Dispute Resolution Certification Form, which is available by contacting HUD by telephone at (202) 708-6423 or by e-mail at *mhs@hud.gov*. The certification may be submitted as a part of, or independent of, a state plan under § 3282.302 of this chapter. If included as part of a state plan, the state does not have to separately certify that it meets the requirements of § 3288.205(a)(4).

(b) *HUD review and action.* (1) HUD will review the Dispute Resolution Certification Form submitted by a state and may contact the state to request additional clarification or information as necessary. Upon completing its review, HUD will provide the state with notice of acceptance, conditional acceptance, or rejection of its dispute resolution program.

(2) A notice of acceptance will include the date of acceptance.

(3) If HUD rejects a state's dispute resolution program, HUD will provide an explanation of what is necessary to obtain full acceptance. A revised Dispute Resolution Certification Form may be submitted within 30 days of receipt of such notification. If the revised Dispute Resolution Certification Form is inadequate or if the state fails to resubmit within the 30-day period or oth-

erwise indicates that it does not intend to change its Dispute Resolution Certification Form, HUD will notify the state that its dispute resolution program is not accepted and that it has a right to a hearing on the rejection using the procedures set forth under subpart D of part 3282 of this chapter.

(c) *Conditional acceptance.* A state meeting three of the four minimum requirements set forth under § 3288.205(a)(1) through (4) will be conditionally accepted by HUD. If HUD conditionally accepts a state's dispute resolution program, HUD will provide an explanation of what is necessary to obtain full acceptance. A revised Dispute Resolution Certification Form may be submitted within 30 days of receipt of such notification. Any state conditionally accepted will be permitted to implement its own dispute resolution program for a period of not more than 3 years, absent extension of this period by HUD.

(d) *Revocation.* If HUD becomes aware at any time that a state no longer meets the minimum requirements set forth under § 3288.205, HUD may revoke acceptance of the state's certification after an opportunity for a hearing, using the procedures set forth under subpart D of part 3282.

(e) *Recertification of a program not included in state plan.* Except as provided in paragraph (f), to maintain its accepted status, a state whose program is not included in an approved or conditionally approved state plan must submit a current Dispute Resolution Certification Form to HUD for review and acceptance as follows:

(1) Every 3 years within 90 days of the day and month of the most recent date of HUD's acceptance of the state's program or

(2) Whenever there is a significant change to the program.

(f) *Inclusion in state plan.* If a state dispute resolution program is part of a state plan, it will be reviewed annually as part of the state plan and separate recertification of the state's dispute resolution program is not required.

§ 3288.215 Effect on other manufactured home program requirements.

A state with an accepted dispute resolution program will operate in lieu of

§ 3288.300

HUD's Manufactured Home Dispute Resolution Program established under subpart B of this part 3288. A state dispute resolution program, even if it is an accepted dispute resolution program under this part, does not supersede the requirements applicable to any other aspect of HUD's manufactured home program. Any responsibilities, rights, and remedies applicable under the Manufactured Home Construction and Safety Standards in part 3280 of this chapter and the Manufactured Home Procedural and Enforcement Regulations in part 3282 of this chapter continue to apply as provided in those parts in all states.

Subpart E—Dispute Resolution Program Rulemaking Procedures

§ 3288.300 Applicability.

This subpart establishes special regulatory procedures for issuing or revising dispute resolution program regulations as codified in this part.

§ 3288.305 Consultation with the Manufactured Housing Consensus Committee.

HUD will seek input from the MHCC when revising the HUD Manufactured Home Dispute Resolution Program regulations in this part 3288. Before publication of a proposed rule to revise these regulations, HUD will provide the MHCC with an opportunity to comment on such revision. The MHCC may send to HUD any of the MHCC's own recommendations to adopt new dispute resolution program regulations or to modify or repeal any of the regulations in this part. Along with each recommendation, the MHCC must set forth pertinent data and arguments in support of the action sought. HUD will either: accept or modify the recommendation and publish it for public comment in accordance with section 553 of the Administrative Procedure Act (5 U.S.C. 553), along with an explanation of the reasons for any such modification; or reject the recommendation entirely, and provide to the MHCC a written explanation of the reasons for the rejection. This section does not supersede section 605 of the National Manufactured Housing Con-

24 CFR Ch. XX (4-1-11 Edition)

struction and Safety Standards Act of 1974 (42 U.S.C. 5404).

PART 3500—REAL ESTATE SETTLEMENT PROCEDURES ACT

Sec.

- 3500.1 Designation and applicability.
- 3500.2 Definitions.
- 3500.3 Questions or suggestions from public and copies of public guidance documents.
- 3500.4 Reliance upon rule, regulation or interpretation by HUD.
- 3500.5 Coverage of RESPA.
- 3500.6 Special information booklet at time of loan application.
- 3500.7 Good faith estimate.
- 3500.8 Use of HUD-1 or HUD-1A settlement statements.
- 3500.9 Reproduction of settlement statements.
- 3500.10 One-day advance inspection of HUD-1 or HUD-1A settlement statement; delivery; recordkeeping.
- 3500.11 Mailing.
- 3500.12 No fee.
- 3500.13 Relation to State laws.
- 3500.14 Prohibition against kickbacks and unearned fees.
- 3500.15 Affiliated business arrangements.
- 3500.16 Title companies.
- 3500.17 Escrow accounts.
- 3500.18 Validity of contracts and liens.
- 3500.19 Enforcement.
- 3500.20 [Reserved]
- 3500.21 Mortgage servicing transfers.
- 3500.22 Severability.
- 3500.23 ESIGN ability.

APPENDIX A TO PART 3500—INSTRUCTIONS FOR COMPLETING HUD-1 AND HUD-1A SETTLEMENT STATEMENTS; SAMPLE HUD-1 AND HUD-1A STATEMENTS

APPENDIX B TO PART 3500—ILLUSTRATIONS OF REQUIREMENTS OF RESPA

APPENDIX C TO PART 3500—INSTRUCTIONS FOR COMPLETING GOOD FAITH ESTIMATE (GFE) FORM

APPENDIX D TO PART 3500—AFFILIATED BUSINESS ARRANGEMENT DISCLOSURE STATEMENT FORMAT

APPENDIX E TO PART 3500—ARITHMETIC STEPS

APPENDIX MS-1 TO PART 3500—SERVICING DISCLOSURE STATEMENT

APPENDIX MS-2 TO PART 3500—NOTICE OF ASSIGNMENT, SALE, OR TRANSFER OF SERVICING RIGHTS

AUTHORITY: 12 U.S.C. 2601 *et seq.*; 42 U.S.C. 3535(d).

SOURCE: 57 FR 49607, Nov. 2, 1992, unless otherwise noted. Sections 3500.1 through 3500.19 and 3500.21 revised at 61 FR 13233, Mar. 26, 1996.

§ 3500.1 Designation and applicability.

(a) *Designation.* This part may be referred to as Regulation X.

(b) *Applicability.* The following sections, as revised by the final rule published on *November 17, 2008*, are applicable as follows:

(1) Sections 3500.8(b), 3500.17, 3500.21, 3500.22 and 3500.23, and Appendices E and MS-1 are applicable commencing January 16, 2009.

(2) Section 203.27, the definitions other than *Required use* in §3500.2, §3500.7, §§3500.8(a) and(c), §3500.9, and Appendices A and C, are applicable commencing January 1, 2010.

[73 FR 68239, Nov. 17, 2008; 74 FR 2370, Jan. 15, 2009, as amended at 74 FR 10174, Mar. 10, 2009; 74 FR 22826, May 15, 2009]

§ 3500.2 Definitions.

(a) *Statutory terms.* All terms defined in RESPA (12 U.S.C. 2602) are used in accordance with their statutory meaning unless otherwise defined in paragraph (b) of this section or elsewhere in this part.

(b) *Other terms.* As used in this part:

Application means the submission of a borrower's financial information in anticipation of a credit decision relating to a federally related mortgage loan, which shall include the borrower's name, the borrower's monthly income, the borrower's social security number to obtain a credit report, the property address, an estimate of the value of the property, the mortgage loan amount sought, and any other information deemed necessary by the loan originator. An application may either be in writing or electronically submitted, including a written record of an oral application.

Balloon payment has the same meaning as "balloon payment" under Regulation Z (12 CFR part 226).

Business day means a day on which the offices of the business entity are open to the public for carrying on substantially all of the entity's business functions.

Changed circumstances means: (1)(i) Acts of God, war, disaster, or other emergency;

(ii) Information particular to the borrower or transaction that was relied on in providing the GFE and that changes or is found to be inaccurate after the

GFE has been provided. This may include information about the credit quality of the borrower, the amount of the loan, the estimated value of the property, or any other information that was used in providing the GFE;

(iii) New information particular to the borrower or transaction that was not relied on in providing the GFE; or

(iv) Other circumstances that are particular to the borrower or transaction, including boundary disputes, the need for flood insurance, or environmental problems.

(2) Changed circumstances do not include:

(i) The borrower's name, the borrower's monthly income, the property address, an estimate of the value of the property, the mortgage loan amount sought, and any information contained in any credit report obtained by the loan originator prior to providing the GFE, unless the information changes or is found to be inaccurate after the GFE has been provided; or

(ii) Market price fluctuations by themselves.

Dealer means, in the case of property improvement loans, a seller, contractor, or supplier of goods or services. In the case of manufactured home loans, "dealer" means one who engages in the business of manufactured home retail sales.

Dealer loan or dealer consumer credit contract means, generally, any arrangement in which a dealer assists the borrower in obtaining a federally related mortgage loan from the funding lender and then assigns the dealer's legal interests to the funding lender and receives the net proceeds of the loan. The funding lender is the lender for the purposes of the disclosure requirements of this part. If a dealer is a "creditor" as defined under the definition of "federally related mortgage loan" in this part, the dealer is the lender for purposes of this part.

Effective date of transfer is defined in section 6(i)(1) of RESPA (12 U.S.C. 2605(i)(1)). In the case of a home equity conversion mortgage or reverse mortgage as referenced in this section, the effective date of transfer is the transfer date agreed upon by the transferee servicer and the transferor servicer.

§ 3500.2

24 CFR Ch. XX (4-1-11 Edition)

Federally related mortgage loan or *mortgage loan* means as follows:

(1) Any loan (other than temporary financing, such as a construction loan):

(i) That is secured by a first or subordinate lien on residential real property, including a refinancing of any secured loan on residential real property upon which there is either:

(A) Located or, following settlement, will be constructed using proceeds of the loan, a structure or structures designed principally for occupancy of from one to four families (including individual units of condominiums and cooperatives and including any related interests, such as a share in the cooperative or right to occupancy of the unit); or

(B) Located or, following settlement, will be placed using proceeds of the loan, a manufactured home; and

(ii) For which one of the following paragraphs applies. The loan:

(A) Is made in whole or in part by any lender that is either regulated by or whose deposits or accounts are insured by any agency of the Federal Government;

(B) Is made in whole or in part, or is insured, guaranteed, supplemented, or assisted in any way:

(1) By the Secretary or any other officer or agency of the Federal Government; or

(2) Under or in connection with a housing or urban development program administered by the Secretary or a housing or related program administered by any other officer or agency of the Federal Government;

(C) Is intended to be sold by the originating lender to the Federal National Mortgage Association, the Government National Mortgage Association, the Federal Home Loan Mortgage Corporation (or its successors), or a financial institution from which the loan is to be purchased by the Federal Home Loan Mortgage Corporation (or its successors);

(D) Is made in whole or in part by a “creditor”, as defined in section 103(f) of the Consumer Credit Protection Act (15 U.S.C. 1602(f)), that makes or invests in residential real estate loans aggregating more than \$1,000,000 per year. For purposes of this definition, the term “creditor” does not include

any agency or instrumentality of any State, and the term “residential real estate loan” means any loan secured by residential real property, including single-family and multifamily residential property;

(E) Is originated either by a dealer or, if the obligation is to be assigned to any maker of mortgage loans specified in paragraphs (1)(ii) (A) through (D) of this definition, by a mortgage broker; or

(F) Is the subject of a home equity conversion mortgage, also frequently called a “reverse mortgage,” issued by any maker of mortgage loans specified in paragraphs (1)(ii) (A) through (D) of this definition.

(2) Any installment sales contract, land contract, or contract for deed on otherwise qualifying residential property is a federally related mortgage loan if the contract is funded in whole or in part by proceeds of a loan made by any maker of mortgage loans specified in paragraphs (1)(ii) (A) through (D) of this definition.

(3) If the residential real property securing a mortgage loan is not located in a State, the loan is not a federally related mortgage loan.

Good faith estimate or *GFE* means an estimate of settlement charges a borrower is likely to incur, as a dollar amount, and related loan information, based upon common practice and experience in the locality of the mortgaged property, as provided on the form prescribed in §3500.7 and prepared in accordance with the Instructions in Appendix C to this part.

HUD-1 or HUD-1A settlement statement (also *HUD-1* or *HUD-1A*) means the statement that is prescribed by the Secretary in this part for setting forth settlement charges in connection with either the purchase or the refinancing (or other subordinate lien transaction) of 1- to 4-family residential property.

Lender means, generally, the secured creditor or creditors named in the debt obligation and document creating the lien. For loans originated by a mortgage broker that closes a federally related mortgage loan in its own name in a table funding transaction, the lender is the person to whom the obligation is initially assigned at or after settlement. A lender, in connection with

dealer loans, is the lender to whom the loan is assigned, unless the dealer meets the definition of creditor as defined under “federally related mortgage loan” in this section. See also §3500.5(b)(7), secondary market transactions.

Loan originator means a lender or mortgage broker.

Managerial employee means an employee of a settlement service provider who does not routinely deal directly with consumers, and who either hires, directs, assigns, promotes, or rewards other employees or independent contractors, or is in a position to formulate, determine, or influence the policies of the employer. Neither the term “managerial employee” nor the term “employee” includes independent contractors, but a managerial employee may hold a real estate brokerage or agency license.

Manufactured home is defined in §3280.2 of this title.

Mortgage broker means a person (not an employee of a lender) or entity that renders origination services and serves as an intermediary between a borrower and a lender in a transaction involving a federally related mortgage loan, including such a person or entity that closes the loan in its own name in a table funded transaction. A loan correspondent approved under 24 CFR 202.8 for Federal Housing Administration programs is a mortgage broker for purposes of this part.

Mortgaged property means the real property that is security for the federally related mortgage loan.

Origination service means any service involved in the creation of a mortgage loan, including but not limited to the taking of the loan application, loan processing, and the underwriting and funding of the loan, and the processing and administrative services required to perform these functions.

Person is defined in section 3(5) of RESPA (12 U.S.C. 2602(5)).

Prepayment penalty has the same meaning as “prepayment penalty” under Regulation Z (12 CFR part 226).

Public Guidance Documents means documents that HUD has published in the FEDERAL REGISTER, and that it may amend from time-to-time by publication in the FEDERAL REGISTER.

These documents are also available from HUD at the address indicated in 24 CFR 3500.3.

Refinancing means a transaction in which an existing obligation that was subject to a secured lien on residential real property is satisfied and replaced by a new obligation undertaken by the same borrower and with the same or a new lender. The following shall not be treated as a refinancing, even when the existing obligation is satisfied and replaced by a new obligation with the same lender (this definition of “refinancing” as to transactions with the same lender is similar to Regulation Z, 12 CFR 226.20(a)):

(1) A renewal of a single payment obligation with no change in the original terms;

(2) A reduction in the annual percentage rate as computed under the Truth in Lending Act with a corresponding change in the payment schedule;

(3) An agreement involving a court proceeding;

(4) A workout agreement, in which a change in the payment schedule or change in collateral requirements is agreed to as a result of the consumer’s default or delinquency, unless the rate is increased or the new amount financed exceeds the unpaid balance plus earned finance charges and premiums for continuation of allowable insurance; and

(5) The renewal of optional insurance purchased by the consumer that is added to an existing transaction, if disclosures relating to the initial purchase were provided.

Regulation Z means the regulations issued by the Board of Governors of the Federal Reserve System (12 CFR part 226) to implement the Federal Truth in Lending Act (15 U.S.C. 1601 *et seq.*), and includes the Commentary on Regulation Z.

Required use means a situation in which a person must use a particular provider of a settlement service in order to have access to some distinct service or property, and the person will pay for the settlement service of the particular provider or will pay a charge attributable, in whole or in part, to the settlement service. However, the offering of a package (or combination of settlement services) or the offering of

§ 3500.2

24 CFR Ch. XX (4-1-11 Edition)

discounts or rebates to consumers for the purchase of multiple settlement services does not constitute a required use. Any package or discount must be optional to the purchaser. The discount must be a true discount below the prices that are otherwise generally available, and must not be made up by higher costs elsewhere in the settlement process.

RESPA means the Real Estate Settlement Procedures Act of 1974, 12 U.S.C. 2601 *et seq.*

Servicer means the person responsible for the servicing of a mortgage loan (including the person who makes or holds a mortgage loan if such person also services the mortgage loan). The term does not include:

(1) The Federal Deposit Insurance Corporation (FDIC) or the Resolution Trust Corporation (RTC), in connection with assets acquired, assigned, sold, or transferred pursuant to section 13(c) of the Federal Deposit Insurance Act or as receiver or conservator of an insured depository institution; and

(2) The Federal National Mortgage Corporation (FNMA); the Federal Home Loan Mortgage Corporation (Freddie Mac); the RTC; the FDIC; HUD, including the Government National Mortgage Association (GNMA) and the Federal Housing Administration (FHA) (including cases in which a mortgage insured under the National Housing Act (12 U.S.C. 1701 *et seq.*) is assigned to HUD); the National Credit Union Administration (NCUA); the Farmers Home Administration or its successor agency under Public Law 103-354 (FmHA); and the Department of Veterans Affairs (VA), in any case in which the assignment, sale, or transfer of the servicing of the mortgage loan is preceded by termination of the contract for servicing the loan for cause, commencement of proceedings for bankruptcy of the servicer, or commencement of proceedings by the FDIC or RTC for conservatorship or receivership of the servicer (or an entity by which the servicer is owned or controlled).

Servicing means receiving any scheduled periodic payments from a borrower pursuant to the terms of any mortgage loan, including amounts for escrow accounts under section 10 of

RESPA (12 U.S.C. 2609), and making the payments to the owner of the loan or other third parties of principal and interest and such other payments with respect to the amounts received from the borrower as may be required pursuant to the terms of the mortgage servicing loan documents or servicing contract. In the case of a home equity conversion mortgage or reverse mortgage as referenced in this section, servicing includes making payments to the borrower.

Settlement means the process of executing legally binding documents regarding a lien on property that is subject to a federally related mortgage loan. This process may also be called “closing” or “escrow” in different jurisdictions.

Settlement service means any service provided in connection with a prospective or actual settlement, including, but not limited to, any one or more of the following:

(1) Origination of a federally related mortgage loan (including, but not limited to, the taking of loan applications, loan processing, and the underwriting and funding of such loans);

(2) Rendering of services by a mortgage broker (including counseling, taking of applications, obtaining verifications and appraisals, and other loan processing and origination services, and communicating with the borrower and lender);

(3) Provision of any services related to the origination, processing or funding of a federally related mortgage loan;

(4) Provision of title services, including title searches, title examinations, abstract preparation, insurability determinations, and the issuance of title commitments and title insurance policies;

(5) Rendering of services by an attorney;

(6) Preparation of documents, including notarization, delivery, and recordation;

(7) Rendering of credit reports and appraisals;

(8) Rendering of inspections, including inspections required by applicable law or any inspections required by the sales contract or mortgage documents prior to transfer of title;

(9) Conducting of settlement by a settlement agent and any related services;

(10) Provision of services involving mortgage insurance;

(11) Provision of services involving hazard, flood, or other casualty insurance or homeowner's warranties;

(12) Provision of services involving mortgage life, disability, or similar insurance designed to pay a mortgage loan upon disability or death of a borrower, but only if such insurance is required by the lender as a condition of the loan;

(13) Provision of services involving real property taxes or any other assessments or charges on the real property;

(14) Rendering of services by a real estate agent or real estate broker; and

(15) Provision of any other services for which a settlement service provider requires a borrower or seller to pay.

Special information booklet means the booklet prepared by the Secretary pursuant to section 5 of RESPA (12 U.S.C. 2604) to help persons understand the nature and costs of settlement services. The Secretary publishes the form of the special information booklet in the FEDERAL REGISTER. The Secretary may issue or approve additional booklets or alternative booklets by publication of a Notice in the FEDERAL REGISTER.

State means any State of the United States, the District of Columbia, the Commonwealth of Puerto Rico, and any territory or possession of the United States.

Table funding means a settlement at which a loan is funded by a contemporaneous advance of loan funds and an assignment of the loan to the person advancing the funds. A table-funded transaction is not a secondary market transaction (see § 3500.5(b)(7)).

Third party means a settlement service provider other than a loan originator.

Title company means any institution, or its duly authorized agent, that is qualified to issue title insurance.

Title service means any service involved in the provision of title insurance (lender's or owner's policy), including but not limited to: title examination and evaluation; preparation and issuance of title commitment; clearance of underwriting objections; preparation and issuance of a title in-

urance policy or policies; and the processing and administrative services required to perform these functions. The term also includes the service of conducting a settlement.

Tolerance means the maximum amount by which the charge for a category or categories of settlement costs may exceed the amount of the estimate for such category or categories on a GFE.

[61 FR 13233, Mar. 26, 1996, as amended at 61 FR 29252, June 7, 1996; 61 FR 58475, Nov. 15, 1996; 62 FR 20088, Apr. 24, 1997; 73 FR 68239, Nov. 17, 2008; 74 FR 22826, May 15, 2009]

EFFECTIVE DATE NOTE: At 61 FR 29252, June 7, 1996, § 3500.2(b) was amended by adding a definition of "managerial employee", effective Oct. 7, 1996. At 61 FR 51782, Oct. 4, 1996, the effective date was delayed until further notice.

§ 3500.3 Questions or suggestions from public and copies of public guidance documents.

Any questions or suggestions from the public regarding RESPA, or requests for copies of HUD Public Guidance Documents, should be directed to the Director, Office of Consumer and Regulatory Affairs, Department of Housing and Urban Development, 451 Seventh Street SW., Washington, DC 20410-8000, rather than to HUD field offices. Legal questions may be directed to the Assistant General Counsel, GSE/RESPA Division, at this address.

§ 3500.4 Reliance upon rule, regulation or interpretation by HUD.

(a) *Rule, regulation or interpretation.*
(1) For purposes of sections 19 (a) and (b) of RESPA (12 U.S.C. 2617 (a) and (b)) only the following constitute a rule, regulation or interpretation of the Secretary:

(i) All provisions, including appendices, of this part. Any other document referred to in this part is not incorporated in this part unless it is specifically set out in this part;

(ii) Any other document that is published in the FEDERAL REGISTER by the Secretary and states that it is an "interpretation," "interpretive rule," "commentary," or a "statement of policy" for purposes of section 19(a) of RESPA. Such documents will be prepared by HUD staff and counsel. Such

§ 3500.5

24 CFR Ch. XX (4–1–11 Edition)

documents may be revoked or amended by a subsequent document published in the FEDERAL REGISTER by the Secretary.

(2) A “rule, regulation, or interpretation thereof by the Secretary” for purposes of section 19(b) of RESPA (12 U.S.C. 2617(b)) shall not include the special information booklet prescribed by the Secretary or any other statement or issuance, whether oral or written, by an officer or representative of the Department of Housing and Urban Development (HUD), letter or memorandum by the Secretary, General Counsel, any Assistant Secretary or other officer or employee of HUD, preamble to a regulation or other issuance of HUD, Public Guidance Document, report to Congress, pleading, affidavit or other document in litigation, pamphlet, handbook, guide, telegraphic communication, explanation, instructions to forms, speech or other material of any nature which is not specifically included in paragraph (a)(1) of this section.

(b) *Unofficial interpretations; staff discretion.* In response to requests for interpretation of matters not adequately covered by this part or by an official interpretation issued under paragraph (a)(1)(ii) of this section, unofficial staff interpretations may be provided at the discretion of HUD staff or counsel. Written requests for such interpretations should be directed to the address indicated in §3500.3. Such interpretations provide no protection under section 19(b) of RESPA (12 U.S.C. 2617(b)). Ordinarily, staff or counsel will not issue unofficial interpretations on matters adequately covered by this part or by official interpretations or commentaries issued under paragraph (a)(1)(ii) of this section.

(c) All informal counsel’s opinions and staff interpretations issued before November 2, 1992, were withdrawn as of that date. Courts and administrative agencies, however, may use previous opinions to determine the validity of conduct under the previous Regulation X.

§ 3500.5 Coverage of RESPA.

(a) *Applicability.* RESPA and this part apply to all federally related mortgage

loans, except for the exemptions provided in paragraph (b) of this section.

(b) *Exemptions.* (1) A loan on property of 25 acres or more.

(2) *Business purpose loans.* An extension of credit primarily for a business, commercial, or agricultural purpose, as defined by Regulation Z, 12 CFR 226.3(a)(1). Persons may rely on Regulation Z in determining whether the exemption applies.

(3) *Temporary financing.* Temporary financing, such as a construction loan. The exemption for temporary financing does not apply to a loan made to finance construction of 1- to 4-family residential property if the loan is used as, or may be converted to, permanent financing by the same lender or is used to finance transfer of title to the first user. If a lender issues a commitment for permanent financing, with or without conditions, the loan is covered by this part. Any construction loan for new or rehabilitated 1- to 4-family residential property, other than a loan to a *bona fide* builder (a person who regularly constructs 1- to 4-family residential structures for sale or lease), is subject to this part if its term is for two years or more. A “bridge loan” or “swing loan” in which a lender takes a security interest in otherwise covered 1- to 4-family residential property is not covered by RESPA and this part.

(4) *Vacant land.* Any loan secured by vacant or unimproved property, unless within two years from the date of the settlement of the loan, a structure or a manufactured home will be constructed or placed on the real property using the loan proceeds. If a loan for a structure or manufactured home to be placed on vacant or unimproved property will be secured by a lien on that property, the transaction is covered by this part.

(5) *Assumption without lender approval.* Any assumption in which the lender does not have the right expressly to approve a subsequent person as the borrower on an existing federally related mortgage loan. Any assumption in which the lender’s permission is both required and obtained is covered by RESPA and this part, whether or not the lender charges a fee for the assumption.

(6) *Loan conversions.* Any conversion of a federally related mortgage loan to different terms that are consistent with provisions of the original mortgage instrument, as long as a new note is not required, even if the lender charges an additional fee for the conversion.

(7) *Secondary market transactions.* A *bona fide* transfer of a loan obligation in the secondary market is not covered by RESPA and this part, except as set forth in section 6 of RESPA (12 U.S.C. 2605) and §3500.21. In determining what constitutes a *bona fide* transfer, HUD will consider the real source of funding and the real interest of the funding lender. Mortgage broker transactions that are table-funded are not secondary market transactions. Neither the creation of a dealer loan or dealer consumer credit contract, nor the first assignment of such loan or contract to a lender, is a secondary market transaction (see §3500.2.)

[61 FR 13233, Mar. 26, 1996, as amended at 61 FR 58475, Nov. 15, 1996]

§ 3500.6 Special information booklet at time of loan application.

(a) *Lender to provide special information booklet.* Subject to the exceptions set forth in this paragraph, the lender shall provide a copy of the special information booklet to a person from whom the lender receives, or for whom the lender prepares, a written application for a federally related mortgage loan. When two or more persons apply together for a loan, the lender is in compliance if the lender provides a copy of the booklet to one of the persons applying.

(1) The lender shall provide the special information booklet by delivering it or placing it in the mail to the applicant not later than three business days (as that term is defined in §3500.2) after the application is received or prepared. However, if the lender denies the borrower's application for credit before the end of the three-business-day period, then the lender need not provide the booklet to the borrower. If a borrower uses a mortgage broker, the mortgage broker shall distribute the special information booklet and the lender need not do so. The intent of this provision is that the applicant re-

ceive the special information booklet at the earliest possible date.

(2) In the case of a federally related mortgage loan involving an open-ended credit plan, as defined in §226.2(a)(20) of Regulation Z (12 CFR), a lender or mortgage broker that provides the borrower with a copy of the brochure entitled "When Your Home is On the Line: What You Should Know About Home Equity Lines of Credit", or any successor brochure issued by the Board of Governors of the Federal Reserve System, is deemed to be in compliance with this section.

(3) In the categories of transactions set forth at the end of this paragraph, the lender or mortgage broker does not have to provide the booklet to the borrower. Under the authority of section 19(a) of RESPA (12 U.S.C. 2617(a)), the Secretary may issue a revised or separate special information booklet that deals with these transactions, or the Secretary may choose to endorse the forms or booklets of other Federal agencies. In such an event, the requirements for delivery by lenders and the availability of the booklet or alternate materials for these transactions will be set forth in a Notice in the FEDERAL REGISTER. This paragraph shall apply to the following transactions:

- (i) Refinancing transactions;
- (ii) Closed-end loans, as defined in 12 CFR 226.2(a)(10) of Regulation Z, when the lender takes a subordinate lien;
- (iii) Reverse mortgages; and
- (iv) Any other federally related mortgage loan whose purpose is not the purchase of a 1- to 4-family residential property.

(b) *Revision.* The Secretary may from time to time revise the special information booklet by publishing a notice in the FEDERAL REGISTER.

(c) *Reproduction.* The special information booklet may be reproduced in any form, provided that no change is made other than as provided under paragraph (d) of this section. The special information booklet may not be made a part of a larger document for purposes of distribution under RESPA and this section. Any color, size and quality of paper, type of print, and method of reproduction may be used so long as the booklet is clearly legible.

§ 3500.7

24 CFR Ch. XX (4-1-11 Edition)

(d) *Permissible changes.* (1) No changes to, deletions from, or additions to the special information booklet currently prescribed by the Secretary shall be made other than those specified in this paragraph (d) or any others approved in writing by the Secretary. A request to the Secretary for approval of any changes shall be submitted in writing to the address indicated in §3500.3, stating the reasons why the applicant believes such changes, deletions or additions are necessary.

(2) The cover of the booklet may be in any form and may contain any drawings, pictures or artwork, provided that the words “settlement costs” are used in the title. Names, addresses and telephone numbers of the lender or others and similar information may appear on the cover, but no discussion of the matters covered in the booklet shall appear on the cover.

(3) The special information booklet may be translated into languages other than English.

§ 3500.7 Good faith estimate.

(a) *Lender to provide.* (1) Except as otherwise provided in paragraphs (a), (b), or (h) of this section, not later than 3 business days after a lender receives an application, or information sufficient to complete an application, the lender must provide the applicant with a GFE. In the case of dealer loans, the lender must either provide the GFE or ensure that the dealer provides the GFE.

(2) The lender must provide the GFE to the loan applicant by hand delivery, by placing it in the mail, or, if the applicant agrees, by fax, e-mail, or other electronic means.

(3) The lender is not required to provide the applicant with a GFE if, before the end of the 3-business-day period:

(i) The lender denies the application; or

(ii) The applicant withdraws the application.

(4) The lender is not permitted to charge, as a condition for providing a GFE, any fee for an appraisal, inspection, or other similar settlement service. The lender may, at its option, charge a fee limited to the cost of a credit report. The lender may not charge additional fees until after the

applicant has received the GFE. If the GFE is mailed to the applicant, the applicant is considered to have received the GFE 3 calendar days after it is mailed, not including Sundays and the legal public holidays specified in 5 U.S.C. 6103(a).

(5) The lender may at any time collect from the loan applicant any information that it requires in addition to the required application information. However, the lender is not permitted to require, as a condition for providing a GFE, that an applicant submit supplemental documentation to verify the information provided on the application.

(b) *Mortgage broker to provide.* (1) Except as otherwise provided in paragraphs (a), (b), or (h) of this section, either the lender or the mortgage broker must provide a GFE not later than 3 business days after a mortgage broker receives either an application or information sufficient to complete an application. The lender is responsible for ascertaining whether the GFE has been provided. If the mortgage broker has provided a GFE, the lender is not required to provide an additional GFE.

(2) The mortgage broker must provide the GFE by hand delivery, by placing it in the mail, or, if the applicant agrees, by fax, email, or other electronic means.

(3) The mortgage broker is not required to provide the applicant with a GFE if, before the end of the 3-business-day period:

(i) The mortgage broker or lender denies the application; or

(ii) The applicant withdraws the application.

(4) The mortgage broker is not permitted to charge, as a condition for providing a GFE, any fee for an appraisal, inspection, or other similar settlement service. The mortgage broker may, at its option, charge a fee limited to the cost of a credit report. The mortgage broker may not charge additional fees until after the applicant has received the GFE. If the GFE is mailed to the applicant, the applicant is considered to have received the GFE 3 calendar days after it is mailed, not including Sundays and the legal public holidays specified in 5 U.S.C. 6103(a).

(5) The mortgage broker may at any time collect from the loan applicant any information that it requires in addition to the required application information. However, the mortgage broker is not permitted to require, as a condition for providing a GFE, that an applicant submit supplemental documentation to verify the information provided on the application.

(c) *Availability of GFE terms.* Except as provided in this paragraph, the estimate of the charges and terms for all settlement services must be available for at least 10 business days from when the GFE is provided, but it may remain available longer, if the loan originator extends the period of availability. The estimate for the following charges are excepted from this requirement: the interest rate, charges and terms dependent upon the interest rate, which includes the charge or credit for the interest rate chosen, the adjusted origination charges, and per diem interest.

(d) *Content and form of GFE.* The GFE form is set out in Appendix C to this part. The loan originator must prepare the GFE in accordance with the requirements of this section and the Instructions in Appendix C to this part. The instructions in Appendix C to this part allow for flexibility in the preparation and distribution of the GFE in hard copy and electronic format.

(e) *Tolerances for amounts included on GFE.* (1) Except as provided in paragraph (f) of this section, the actual charges at settlement may not exceed the amounts included on the GFE for:

- (i) The origination charge;
- (ii) While the borrower's interest rate is locked, the credit or charge for the interest rate chosen;
- (iii) While the borrower's interest rate is locked, the adjusted origination charge; and
- (iv) Transfer taxes.

(2) Except as provided in paragraph (f) below, the sum of the charges at settlement for the following services may not be greater than 10 percent above the sum of the amounts included on the GFE:

- (i) Lender-required settlement services, where the lender selects the third party settlement service provider;
- (ii) Lender-required services, title services and required title insurance,

and owner's title insurance, when the borrower uses a settlement service provider identified by the loan originator; and

(iii) Government recording charges.

(3) The amounts charged for all other settlement services included on the GFE may change at settlement.

(f) *Binding GFE.* The loan originator is bound, within the tolerances provided in paragraph (e) of this section, to the settlement charges and terms listed on the GFE provided to the borrower, unless a new GFE is provided prior to settlement consistent with this paragraph (f). If a loan originator provides a revised GFE consistent with this paragraph, the loan originator must document the reason that a new GFE was provided. Loan originators must retain documentation of any reasons for providing a new GFE for no less than 3 years after settlement.

(1) *Changed circumstances affecting settlement costs.* If changed circumstances result in increased costs for any settlement services such that the charges at settlement would exceed the tolerances for those charges, the loan originator may provide a revised GFE to the borrower. If a revised GFE is to be provided, the loan originator must do so within 3 business days of receiving information sufficient to establish changed circumstances. The revised GFE may increase charges for services listed on the GFE only to the extent that the changed circumstances actually resulted in higher charges.

(2) *Changed circumstances affecting loan.* If changed circumstances result in a change in the borrower's eligibility for the specific loan terms identified in the GFE, the loan originator may provide a revised GFE to the borrower. If a revised GFE is to be provided, the loan originator must do so within 3 business days of receiving information sufficient to establish changed circumstances.

(3) *Borrower-requested changes.* If a borrower requests changes to the mortgage loan identified in the GFE that change the settlement charges or the terms of the loan, the loan originator may provide a revised GFE to the borrower. If a revised GFE is to be provided, the loan originator must do so

§ 3500.8

24 CFR Ch. XX (4-1-11 Edition)

within 3 business days of the borrower's request.

(4) *Expiration of original GFE.* If a borrower does not express an intent to continue with an application within 10 business days after the GFE is provided, or such longer time specified by the loan originator pursuant to paragraph (c) above, the loan originator is no longer bound by the GFE.

(5) *Interest rate dependent charges and terms.* If the interest rate has not been locked by the borrower, or a locked interest rate has expired, the charge or credit for the interest rate chosen, the adjusted origination charges, per diem interest, and loan terms related to the interest rate may change. If the borrower later locks the interest rate, a new GFE must be provided showing the revised interest rate-dependent charges and terms. All other charges and terms must remain the same as on the original GFE, except as otherwise provided in paragraph (f) of this section.

(6) *New home purchases.* In transactions involving new home purchases, where settlement is anticipated to occur more than 60 calendar days from the time a GFE is provided, the loan originator may provide the GFE to the borrower with a clear and conspicuous disclosure stating that at any time up until 60 calendar days prior to closing, the loan originator may issue a revised GFE. If no such separate disclosure is provided, the loan originator cannot issue a revised GFE, except as otherwise provided in paragraph (f) of this section.

(g) *GFE is not a loan commitment.* Nothing in this section shall be interpreted to require a loan originator to make a loan to a particular borrower. The loan originator is not required to provide a GFE if the loan originator does not have available a loan for which the borrower is eligible.

(h) *Open-end lines of credit (home-equity plans) under Truth in Lending Act.* In the case of a federally related mortgage loan involving an open-end line of credit (home-equity plan) covered under the Truth in Lending Act and Regulation Z, a lender or mortgage broker that provides the borrower with the disclosures required by 12 CFR 226.5b of Regulation Z at the time the borrower applies for such loan shall be

deemed to satisfy the requirements of this section.

(i) *Violations of section 5 of RESPA (12 U.S.C. 2604).* A loan originator that violates the requirements of this section shall be deemed to have violated section 5 of RESPA. If any charges at settlement exceed the charges listed on the GFE by more than the permitted tolerances, the loan originator may cure the tolerance violation by reimbursing to the borrower the amount by which the tolerance was exceeded, at settlement or within 30 calendar days after settlement. A borrower will be deemed to have received timely reimbursement if the loan originator delivers or places the payment in the mail within 30 calendar days after settlement.

(Approved by the Office of Management and Budget under control number 2502-0265)

[61 FR 13233, Mar. 26, 1996, as amended at 61 FR 58476, Nov. 15, 1996; 73 FR 68240, Nov. 17, 2008]

§ 3500.8 Use of HUD-1 or HUD-1A settlement statements.

(a) *Use by settlement agent.* The settlement agent shall use the HUD-1 settlement statement in every settlement involving a federally related mortgage loan in which there is a borrower and a seller. For transactions in which there is a borrower and no seller, such as refinancing loans or subordinate lien loans, the HUD-1 may be utilized by using the borrower's side of the HUD-1 statement. Alternatively, the form HUD-1A may be used for these transactions. The HUD-1 or HUD-1A may be modified as permitted under this part. Either the HUD-1 or the HUD-1A, as appropriate, shall be used for every RESPA-covered transaction, unless its use is specifically exempted. The use of the HUD-1 or HUD-1A is exempted for open-end lines of credit (home-equity plans) covered by the Truth in Lending Act and Regulation Z.

(b) *Charges to be stated.* The settlement agent shall complete the HUD-1 or HUD-1A, in accordance with the instructions set forth in Appendix A to this part. The loan originator must transmit to the settlement agent all information necessary to complete the HUD-1 or HUD-1A.

(1) *In general.* The settlement agent shall state the actual charges paid by the borrower and seller on the HUD-1, or by the borrower on the HUD-1A. The settlement agent must separately itemize each third party charge paid by the borrower and seller. All origination services performed by or on behalf of the loan originator must be included in the loan originator's own charge. Administrative and processing services related to title services must be included in the title underwriter's or title agent's own charge. The amount stated on the HUD-1 or HUD-1A for any itemized service cannot exceed the amount actually received by the settlement service provider for that itemized service, unless the charge is an average charge in accordance with paragraph (b)(2) of this section.

(2) *Use of average charge.* (i) The average charge for a settlement service shall be no more than the average amount paid for a settlement service by one settlement service provider to another settlement service provider on behalf of borrowers and sellers for a particular class of transactions involving federally related mortgage loans. The total amounts paid by borrowers and sellers for a settlement service based on the use of an average charge may not exceed the total amounts paid to the providers of that service for the particular class of transactions.

(ii) The settlement service provider shall define the particular class of transactions for purposes of calculating the average charge as all transactions involving federally related mortgage loans for:

(A) A period of time as determined by the settlement service provider, but not less than 30 calendar days and not more than 6 months;

(B) A geographic area as determined by the settlement service provider; and

(C) A type of loan as determined by the settlement service provider.

(iii) A settlement service provider may use an average charge in the same class of transactions for which the charge was calculated. If the settlement service provider uses the average charge for any transaction in the class, the settlement service provider must use the same average charge in every

transaction within that class for which a GFE was provided.

(iv) The use of an average charge is not permitted for any settlement service if the charge for the service is based on the loan amount or property value. For example, an average charge may not be used for transfer taxes, interest charges, reserves or escrow, or any type of insurance, including mortgage insurance, title insurance, or hazard insurance.

(v) The settlement service provider must retain all documentation used to calculate the average charge for a particular class of transactions for at least 3 years after any settlement for which that average charge was used.

(c) *Violations of section 4 of RESPA (12 U.S.C. 2604).* A violation of any of the requirements of this section will be deemed to be a violation of section 4 of RESPA. An inadvertent or technical error in completing the HUD-1 or HUD-1A shall not be deemed a violation of section 4 of RESPA if a revised HUD-1 or HUD-1A is provided in accordance with the requirements of this section within 30 calendar days after settlement.

[73 FR 68241, Nov. 17, 2008]

§ 3500.9 Reproduction of settlement statements.

(a) *Permissible changes—HUD-1.* The following changes and insertions are permitted when the HUD-1 settlement statement is reproduced:

(1) The person reproducing the HUD-1 may insert its business name and logo in section A and may rearrange, but not delete, the other information that appears in section A.

(2) The name, address, and other information regarding the lender and settlement agent may be printed in sections F and H, respectively.

(3) Reproduction of the HUD-1 must conform to the terminology, sequence, and numbering of line items as presented in lines 100-1400. However, blank lines or items listed in lines 100-1400 that are not used locally or in connection with mortgages by the lender may be deleted, except for the following: Lines 100, 120, 200, 220, 300, 301, 302, 303, 400, 420, 500, 520, 600, 601, 602, 603, 700, 800, 900, 1000, 1100, 1200, 1300, and 1400.

§ 3500.10

The form may be shortened correspondingly. The number of a deleted item shall not be used for a substitute or new item, but the number of a blank space on the HUD-1 may be used for a substitute or new item.

(4) Charges not listed on the HUD-1, but that are customary locally or pursuant to the lender's practice, may be inserted in blank spaces. Where existing blank spaces on the HUD-1 are insufficient, additional lines and spaces may be added and numbered in sequence with spaces on the HUD-1.

(5) The following variations in layout and format are within the discretion of persons reproducing the HUD-1 and do not require prior HUD approval: size of pages; tint or color of pages; size and style of type or print; vertical spacing between lines or provision for additional horizontal space on lines (for example, to provide sufficient space for recording time periods used in proration); printing of the HUD-1 contents on separate pages, on the front and back of a single page, or on one continuous page; use of multicopy tear-out sets; printing on rolls for computer purposes; reorganization of sections B through I, when necessary to accommodate computer printing; and manner of placement of the HUD number, but not the OMB approval number, neither of which may be deleted. The designation of the expiration date of the OMB number may be deleted. Any changes in the HUD number or OMB approval number may be announced by notice in the FEDERAL REGISTER, rather than by amendment of this part.

(6) The borrower's information and the seller's information may be provided on separate pages.

(7) Signature lines may be added.

(8) The HUD-1 may be translated into languages other than English.

(9) An additional page may be attached to the HUD-1 for the purpose of including customary recitals and information used locally in real estate settlements; for example, breakdown of payoff figures, a breakdown of the borrower's total monthly mortgage payments, check disbursements, a statement indicating receipt of funds, applicable special stipulations between buyer and seller, and the date funds are transferred. If space permits, such in-

24 CFR Ch. XX (4-1-11 Edition)

formation may be added at the end of the HUD-1.

(10) As required by HUD/FHA in FHA-insured loans.

(11) As allowed by § 3500.17, relating to an initial escrow account statement.

(b) *Permissible changes—HUD-1A.* The changes and insertions on the HUD-1 permitted under paragraph (a) of this section are also permitted when the HUD-1A settlement statement is reproduced, except the changes described in paragraphs (a)(3) and (6) of this section.

(c) *Written approval.* Any other deviation in the HUD-1 or HUD-1A forms is permissible only upon receipt of written approval of the Secretary. A request to the Secretary for approval shall be submitted in writing to the address indicated in § 3500.3 and shall state the reasons why the applicant believes such deviation is needed. The prescribed form(s) must be used until approval is received.

(Approved by the Office of Management and Budget under control numbers 2502-0265 and 2502-0491)

[61 FR 13233, Mar. 26, 1996, as amended at 73 FR 68242, Nov. 17, 2008]

§ 3500.10 One-day advance inspection of HUD-1 or HUD-1A settlement statement; delivery; recordkeeping.

(a) *Inspection one day prior to settlement upon request by the borrower.* The settlement agent shall permit the borrower to inspect the HUD-1 or HUD-1A settlement statement, completed to set forth those items that are known to the settlement agent at the time of inspection, during the business day immediately preceding settlement. Items related only to the seller's transaction may be omitted from the HUD-1.

(b) *Delivery.* The settlement agent shall provide a completed HUD-1 or HUD-1A to the borrower, the seller (if there is one), the lender (if the lender is not the settlement agent), and/or their agents. When the borrower's and seller's copies of the HUD-1 or HUD-1A differ as permitted by the instructions in appendix A to this part, both copies shall be provided to the lender (if the lender is not the settlement agent). The settlement agent shall deliver the completed HUD-1 or HUD-1A at or before the settlement, except as provided

in paragraphs (c) and (d) of this section.

(c) *Waiver.* The borrower may waive the right to delivery of the completed HUD-1 or HUD-1A no later than at settlement by executing a written waiver at or before settlement. In such case, the completed HUD-1 or HUD-1A shall be mailed or delivered to the borrower, seller, and lender (if the lender is not the settlement agent) as soon as practicable after settlement.

(d) *Exempt transactions.* When the borrower or the borrower's agent does not attend the settlement, or when the settlement agent does not conduct a meeting of the parties for that purpose, the transaction shall be exempt from the requirements of paragraphs (a) and (b) of this section, except that the HUD-1 or HUD-1A shall be mailed or delivered as soon as practicable after settlement.

(e) *Recordkeeping.* The lender shall retain each completed HUD-1 or HUD-1A and related documents for five years after settlement, unless the lender disposes of its interest in the mortgage and does not service the mortgage. In that case, the lender shall provide its copy of the HUD-1 or HUD-1A to the owner or servicer of the mortgage as a part of the transfer of the loan file. Such owner or servicer shall retain the HUD-1 or HUD-1A for the remainder of the five-year period. The Secretary shall have the right to inspect or require copies of records covered by this paragraph (e).

(Approved by the Office of Management and Budget under control number 2502-0265)

§ 3500.11 Mailing.

The provisions of this part requiring or permitting mailing of documents shall be deemed to be satisfied by placing the document in the mail (whether or not received by the addressee) addressed to the addresses stated in the loan application or in other information submitted to or obtained by the lender at the time of loan application or submitted or obtained by the lender or settlement agent, except that a revised address shall be used where the lender or settlement agent has been expressly informed in writing of a change in address.

§ 3500.12 No fee.

No fee shall be imposed or charge made upon any other person, as a part of settlement costs or otherwise, by a lender in connection with a federally related mortgage loan made by it (or a loan for the purchase of a manufactured home), or by a servicer (as that term is defined under 12 U.S.C. 2605(i)(2)) for or on account of the preparation and distribution of the HUD-1 or HUD-1A settlement statement, escrow account statements required pursuant to section 10 of RESPA (12 U.S.C. 2609), or statements required by the Truth in Lending Act, 15 U.S.C. 1601 *et seq.*

§ 3500.13 Relation to State laws.

(a) State laws that are inconsistent with RESPA or this part are preempted to the extent of the inconsistency. However, RESPA and these regulations do not annul, alter, affect, or exempt any person subject to their provisions from complying with the laws of any State with respect to settlement practices, except to the extent of the inconsistency.

(b) Upon request by any person, the Secretary is authorized to determine if inconsistencies with State law exist; in doing so, the Secretary shall consult with appropriate Federal agencies.

(1) The Secretary may not determine that a State law or regulation is inconsistent with any provision of RESPA or this part, if the Secretary determines that such law or regulation gives greater protection to the consumer.

(2) In determining whether provisions of State law or regulations concerning affiliated business arrangements are inconsistent with RESPA or this part, the Secretary may not construe those provisions that impose more stringent limitations on affiliated business arrangements as inconsistent with RESPA so long as they give more protection to consumers and/or competition.

(c) Any person may request the Secretary to determine whether an inconsistency exists by submitting to the address indicated in § 3500.3, a copy of the State law in question, any other

§ 3500.14

24 CFR Ch. XX (4-1-11 Edition)

law or judicial or administrative opinion that implements, interprets or applies the relevant provision, and an explanation of the possible inconsistency. A determination by the Secretary that an inconsistency with State law exists will be made by publication of a notice in the FEDERAL REGISTER. "Law" as used in this section includes regulations and any enactment which has the force and effect of law and is issued by a State or any political subdivision of a State.

(d) A specific preemption of conflicting State laws regarding notices and disclosures of mortgage servicing transfers is set forth in § 3500.21(h).

[61 FR 13233, Mar. 26, 1996, as amended at 61 FR 58476, Nov. 15, 1996]

§ 3500.14 Prohibition against kickbacks and unearned fees.

(a) *Section 8 violation.* Any violation of this section is a violation of section 8 of RESPA (12 U.S.C. 2607) and is subject to enforcement as such under § 3500.19.

(b) *No referral fees.* No person shall give and no person shall accept any fee, kickback or other thing of value pursuant to any agreement or understanding, oral or otherwise, that business incident to or part of a settlement service involving a federally related mortgage loan shall be referred to any person. Any referral of a settlement service is not a compensable service, except as set forth in § 3500.14(g)(1). A company may not pay any other company or the employees of any other company for the referral of settlement service business.

(c) *No split of charges except for actual services performed.* No person shall give and no person shall accept any portion, split, or percentage of any charge made or received for the rendering of a settlement service in connection with a transaction involving a federally related mortgage loan other than for services actually performed. A charge by a person for which no or nominal services are performed or for which duplicative fees are charged is an unearned fee and violates this section. The source of the payment does not determine whether or not a service is compensable. Nor may the prohibitions of this part be avoided by creating an

arrangement wherein the purchaser of services splits the fee.

(d) *Thing of value.* This term is broadly defined in section 3(2) of RESPA (12 U.S.C. 2602(2)). It includes, without limitation, monies, things, discounts, salaries, commissions, fees, duplicate payments of a charge, stock, dividends, distributions of partnership profits, franchise royalties, credits representing monies that may be paid at a future date, the opportunity to participate in a money-making program, retained or increased earnings, increased equity in a parent or subsidiary entity, special bank deposits or accounts, special or unusual banking terms, services of all types at special or free rates, sales or rentals at special prices or rates, lease or rental payments based in whole or in part on the amount of business referred, trips and payment of another person's expenses, or reduction in credit against an existing obligation. The term "payment" is used throughout §§ 3500.14 and 3500.15 as synonymous with the giving or receiving any "thing of value" and does not require transfer of money.

(e) *Agreement or understanding.* An agreement or understanding for the referral of business incident to or part of a settlement service need not be written or verbalized but may be established by a practice, pattern or course of conduct. When a thing of value is received repeatedly and is connected in any way with the volume or value of the business referred, the receipt of the thing of value is evidence that it is made pursuant to an agreement or understanding for the referral of business.

(f) *Referral.* (1) A referral includes any oral or written action directed to a person which has the effect of affirmatively influencing the selection by any person of a provider of a settlement service or business incident to or part of a settlement service when such person will pay for such settlement service or business incident thereto or pay a charge attributable in whole or in part to such settlement service or business.

(2) A referral also occurs whenever a person paying for a settlement service or business incident thereto is required to use (see § 3500.2, "required use") a

particular provider of a settlement service or business incident thereto.

(g) *Fees, salaries, compensation, or other payments.* (1) Section 8 of RESPA permits:

(i) A payment to an attorney at law for services actually rendered;

(ii) A payment by a title company to its duly appointed agent for services actually performed in the issuance of a policy of title insurance;

(iii) A payment by a lender to its duly appointed agent or contractor for services actually performed in the origination, processing, or funding of a loan;

(iv) A payment to any person of a *bona fide* salary or compensation or other payment for goods or facilities actually furnished or for services actually performed;

(v) A payment pursuant to cooperative brokerage and referral arrangements or agreements between real estate agents and real estate brokers. (The statutory exemption restated in this paragraph refers only to fee divisions within real estate brokerage arrangements when all parties are acting in a real estate brokerage capacity, and has no applicability to any fee arrangements between real estate brokers and mortgage brokers or between mortgage brokers.);

(vi) Normal promotional and educational activities that are not conditioned on the referral of business and that do not involve the defraying of expenses that otherwise would be incurred by persons in a position to refer settlement services or business incident thereto; or

(vii) An employer's payment to its own employees for any referral activities.

(2) The Department may investigate high prices to see if they are the result of a referral fee or a split of a fee. If the payment of a thing of value bears no reasonable relationship to the market value of the goods or services provided, then the excess is not for services or goods actually performed or provided. These facts may be used as evidence of a violation of section 8 and may serve as a basis for a RESPA investigation. High prices standing alone are not proof of a RESPA violation. The value of a referral (i.e., the value of any addi-

tional business obtained thereby) is not to be taken into account in determining whether the payment exceeds the reasonable value of such goods, facilities or services. The fact that the transfer of the thing of value does not result in an increase in any charge made by the person giving the thing of value is irrelevant in determining whether the act is prohibited.

(3) *Multiple services.* When a person in a position to refer settlement service business, such as an attorney, mortgage lender, real estate broker or agent, or developer or builder, receives a payment for providing additional settlement services as part of a real estate transaction, such payment must be for services that are actual, necessary and distinct from the primary services provided by such person. For example, for an attorney of the buyer or seller to receive compensation as a title agent, the attorney must perform core title agent services (for which liability arises) separate from attorney services, including the evaluation of the title search to determine the insurability of the title, the clearance of underwriting objections, the actual issuance of the policy or policies on behalf of the title insurance company, and, where customary, issuance of the title commitment, and the conducting of the title search and closing.

(h) *Recordkeeping.* Any documents provided pursuant to this section shall be retained for five (5) years from the date of execution.

(i) *Appendix B of this part.* Illustrations in appendix B of this part demonstrate some of the requirements of this section.

[61 FR 13233, Mar. 26, 1996, as amended at 61 FR 29252, June 7, 1996; 61 FR 58476, Nov. 15, 1996]

EFFECTIVE DATE NOTE: At 61 FR 29252, June 7, 1996, §3500.14 was amended by revising the last sentence of paragraph (b), the heading of paragraph (g), and paragraph (g)(1), effective Oct. 7, 1996. At 61 FR 51782, Oct. 4, 1996, the effective date was delayed until further notice. For the convenience of the user, the new text is set forth as follows:

§ 3500.14 Prohibition against kickbacks and unearned fees.

* * * * *

§ 3500.15

24 CFR Ch. XX (4-1-11 Edition)

(b) * * * A business entity (whether or not in an affiliate relationship) may not pay any other business entity or the employees of any other business entity for the referral of settlement service business.

* * * * *

(g) Exemptions for fees, salaries, compensation, or other payments. (1) The following are permissible:

(i) A payment to an attorney at law for services actually rendered;

(ii) A payment by a title company to its duly appointed agent for services actually performed in the issuance of a policy of title insurance;

(iii) A payment by a lender to its duly appointed agent or contractor for services actually performed in the origination, processing, or funding of a loan;

(iv) A payment to any person of a bona fide salary or compensation or other payment for goods or facilities actually furnished or for services actually performed;

(v) A payment pursuant to cooperative brokerage and referral arrangements or agreements between real estate agents and real estate brokers. (The statutory exemption restated in this paragraph refers only to fee divisions within real estate brokerage arrangements when all parties are acting in a real estate brokerage capacity, and has no applicability to any fee arrangements between real estate brokers and mortgage brokers or between mortgage brokers.)

(vi) Normal promotional and educational activities that are not conditioned on the referral of business and do not involve the defraying of expenses that otherwise would be incurred by persons in a position to refer settlement services or business incident thereto;

(vii) A payment by an employer to its own bona fide employee for generating business for that employer;

(viii) In a controlled business arrangement, a payment by an employer of a bonus to a managerial employee based on criteria relating to performance (such as profitability, capture rate, or other thresholds) of a business entity in the controlled business arrangement. However, the amount of such bonus may not be calculated as a multiple of the number or value of referrals of settlement service business to a business entity in a controlled business arrangement; and

(ix)(A) A payment by an employer to its bona fide employee for the referral of settlement service business to a settlement service provider that has an affiliate relationship with the employer or in which the employer has a direct or beneficial ownership interest of more than 1 percent, if the following conditions are met:

(1) The employee does not perform settlement services in any transaction; and

(2) Before the referral, the employee provides to the person being referred a written disclosure in the format of the Controlled Business Arrangement Disclosure Statement, set forth in appendix D to this part.

(B) For purposes of this paragraph (g)(1)(ix), the marketing of a settlement service or product of an affiliated entity, including the collection and conveyance of information or the taking of an application or order for an affiliated entity, does not constitute the performance of a settlement service. Under this paragraph (g)(1)(ix), marketing of a settlement service or product may include incidental communications with the consumer after the application or order, such as providing the consumer with information about the status of an application or order; marketing shall not include serving as the ongoing point of contact for coordinating the delivery and provision of settlement services.

* * * * *

§ 3500.15 Affiliated business arrangements.

(a) General. An affiliated business arrangement is defined in section 3(7) of RESPA (12 U.S.C. 2602(7)).

(b) Violation and exemption. An affiliated business arrangement is not a violation of section 8 of RESPA (12 U.S.C. 2607) and of § 3500.14 if the conditions set forth in this section are satisfied. Paragraph (b)(1) of this section shall not apply to the extent it is inconsistent with section 8(c)(4)(A) of RESPA (12 U.S.C. 2607(c)(4)(A)).

(1) The person making each referral has provided to each person whose business is referred a written disclosure, in the format of the Affiliated Business Arrangement Disclosure Statement set forth in appendix D of this part, of the nature of the relationship (explaining the ownership and financial interest) between the provider of settlement services (or business incident thereto) and the person making the referral and of an estimated charge or range of charges generally made by such provider (which describes the charge using the same terminology, as far as practical, as section L of the HUD-1 settlement statement). The disclosures must be provided on a separate piece of paper no later than the time of each referral or, if the lender requires use of a particular provider,

the time of loan application, except that:

(i) Where a lender makes the referral to a borrower, the condition contained in paragraph (b)(1) of this section may be satisfied at the time that the good faith estimate or a statement under § 3500.7(d) is provided; and

(ii) Whenever an attorney or law firm requires a client to use a particular title insurance agent, the attorney or law firm shall provide the disclosures no later than the time the attorney or law firm is engaged by the client. Failure to comply with the disclosure requirements of this section may be overcome if the person making a referral can prove by a preponderance of the evidence that procedures reasonably adopted to result in compliance with these conditions have been maintained and that any failure to comply with these conditions was unintentional and the result of a *bona fide* error. An error of legal judgment with respect to a person's obligations under RESPA is not a *bona fide* error. Administrative and judicial interpretations of section 130(c) of the Truth in Lending Act shall not be binding interpretations of the preceding sentence or section 8(d)(3) of RESPA (12 U.S.C. 2607(d)(3)).

(2) No person making a referral has required (as defined in § 3500.2, "required use") any person to use any particular provider of settlement services or business incident thereto, except if such person is a lender, for requiring a buyer, borrower or seller to pay for the services of an attorney, credit reporting agency, or real estate appraiser chosen by the lender to represent the lender's interest in a real estate transaction, or except if such person is an attorney or law firm for arranging for issuance of a title insurance policy for a client, directly as agent or through a separate corporate title insurance agency that may be operated as an adjunct to the law practice of the attorney or law firm, as part of representation of that client in a real estate transaction.

(3) The only thing of value that is received from the arrangement other than payments listed in § 3500.14(g) is a return on an ownership interest or franchise relationship.

(i) In an affiliated business arrangement:

(A) *Bona fide* dividends, and capital or equity distributions, related to ownership interest or franchise relationship, between entities in an affiliate relationship, are permissible; and

(B) *Bona fide* business loans, advances, and capital or equity contributions between entities in an affiliate relationship (in any direction), are not prohibited—so long as they are for ordinary business purposes and are not fees for the referral of settlement service business or unearned fees.

(ii) A return on an ownership interest does not include:

(A) Any payment which has as a basis of calculation no apparent business motive other than distinguishing among recipients of payments on the basis of the amount of their actual, estimated or anticipated referrals;

(B) Any payment which varies according to the relative amount of referrals by the different recipients of similar payments; or

(C) A payment based on an ownership, partnership or joint venture share which has been adjusted on the basis of previous relative referrals by recipients of similar payments.

(iii) Neither the mere labelling of a thing of value, nor the fact that it may be calculated pursuant to a corporate or partnership organizational document or a franchise agreement, will determine whether it is a *bona fide* return on an ownership interest or franchise relationship. Whether a thing of value is such a return will be determined by analyzing facts and circumstances on a case by case basis.

(iv) A return on franchise relationship may be a payment to or from a franchisee but it does not include any payment which is not based on the franchise agreement, nor any payment which varies according to the number or amount of referrals by the franchisor or franchisee or which is based on a franchise agreement which has been adjusted on the basis of a previous number or amount of referrals by the franchisor or franchisees. A franchise agreement may not be constructed to insulate against kickbacks or referral fees.

§ 3500.16

24 CFR Ch. XX (4-1-11 Edition)

(c) *Definitions.* As used in this section:

(1) *Associate* is defined in section 3(8) of RESPA (12 U.S.C. 2602(8)).

(2) *Affiliate relationship* means the relationship among business entities where one entity has effective control over the other by virtue of a partnership or other agreement or is under common control with the other by a third entity or where an entity is a corporation related to another corporation as parent to subsidiary by an identity of stock ownership.

(3) *Beneficial ownership* means the effective ownership of an interest in a provider of settlement services or the right to use and control the ownership interest involved even though legal ownership or title may be held in another person's name.

(4) *Control*, as used in the definitions of "associate" and "affiliate relationship," means that a person:

(i) Is a general partner, officer, director, or employer of another person;

(ii) Directly or indirectly or acting in concert with others, or through one or more subsidiaries, owns, holds with power to vote, or holds proxies representing, more than 20 percent of the voting interests of another person;

(iii) Affirmatively influences in any manner the election of a majority of the directors of another person; or

(iv) Has contributed more than 20 percent of the capital of the other person.

(5) *Direct ownership* means the holding of legal title to an interest in a provider of settlement service except where title is being held for the beneficial owner.

(6) *Franchise* is defined in 16 CFR 436.2(a).

(7) *Franchisor* is defined in 16 CFR 436.2(c).

(8) *Franchisee* is defined in 16 CFR 436.2(d).

(9) *Person who is in a position to refer settlement service business* means any real estate broker or agent, lender, mortgage broker, builder or developer, attorney, title company, title agent, or other person deriving a significant portion of his or her gross income from providing settlement services.

(d) *Recordkeeping.* Any documents provided pursuant to this section shall

be retained for 5 years after the date of execution.

(e) *Appendix B of this part.* Illustrations in appendix B of this part demonstrate some of the requirements of this section.

[61 FR 13233, Mar. 26, 1996, as amended at 61 FR 29252, June 7, 1996; 61 FR 58476, Nov. 15, 1996]

EFFECTIVE DATE NOTE: At 61 FR 29252, June 7, 1996, §3500.15 was amended by revising the introductory text of paragraph (b)(1), effective Oct. 7, 1996. At 61 FR 51782, Oct. 4, 1996, the effective date was delayed until further notice. For the convenience of the user, the new text is set forth as follows:

§ 3500.15 Controlled business arrangements.

* * * * *

(b) * * *

(1) Prior to the referral, the person making a referral has provided to each person whose business is referred a written disclosure, in the format of the Controlled Business Arrangement Disclosure Statement set forth in appendix D of this part. This disclosure shall specify the nature of the relationship (explaining the ownership and financial interest) between the person performing settlement services (or business incident thereto) and the person making the referral, and shall describe the estimated charge or range of charges (using the same terminology, as far as practical, as section L of the HUD-1 or HUD-1A settlement statement) generally made by the provider of settlement services. The disclosure must be provided on a separate piece of paper no later than the time of each referral or, if the lender requires the use of a particular provider, the time of loan application, except that:

* * * * *

§ 3500.16 Title companies.

No seller of property that will be purchased with the assistance of a federally related mortgage loan shall violate section 9 of RESPA (12 U.S.C. 2608). Section 3500.2 defines "required use" of a provider of a settlement service. Section 3500.19(c) explains the liability of a seller for a violation of this section.

§ 3500.17 Escrow accounts.

(a) *General.* This section sets out the requirements for an escrow account that a lender establishes in connection with a federally related mortgage loan.

It sets limits for escrow accounts using calculations based on monthly payments and disbursements within a calendar year. If an escrow account involves biweekly or any other payment period, the requirements in this section shall be modified accordingly. A HUD Public Guidance Document entitled “Biweekly Payments—Example” provides examples of biweekly accounting and a HUD Public Guidance Document entitled “Annual Escrow Account Disclosure Statement—Example” provides examples of a 3-year accounting cycle that may be used in accordance with paragraph (c)(9) of this section. A HUD Public Guidance Document entitled “Consumer Disclosure for Voluntary Escrow Account Payments” provides a model disclosure format that originators and servicers are encouraged, but not required, to provide to consumers when the originator or servicer anticipates a substantial increase in disbursements from the escrow account after the first year of the loan. The disclosures in that model format may be combined with or included in the Initial Escrow Account Statement required in § 3500.17(g).

(b) *Definitions.* As used in this section:

Aggregate (or) composite analysis, hereafter called *aggregate analysis*, means an accounting method a servicer uses in conducting an escrow account analysis by computing the sufficiency of escrow account funds by analyzing the account as a whole. Appendix E to this part sets forth examples of aggregate escrow account analyses.

Annual escrow account statement means a statement containing all of the information set forth in § 3500.17(i). As noted in § 3500.17(i), a servicer shall submit an annual escrow account statement to the borrower within 30 calendar days of the end of the escrow account computation year, after conducting an escrow account analysis.

Cushion or reserve (hereafter *cushion*) means funds that a servicer may require a borrower to pay into an escrow account to cover unanticipated disbursements or disbursements made before the borrower’s payments are available in the account, as limited by § 3500.17(c).

Deficiency is the amount of a negative balance in an escrow account. As noted in § 3500.17(f), if a servicer advances funds for a borrower, then the servicer must perform an escrow account analysis before seeking repayment of the deficiency.

Delivery means the placing of a document in the United States mail, first-class postage paid, addressed to the last known address of the recipient. Hand delivery also constitutes delivery.

Disbursement date means the date on which the servicer actually pays an escrow item from the escrow account.

Escrow account means any account that a servicer establishes or controls on behalf of a borrower to pay taxes, insurance premiums (including flood insurance), or other charges with respect to a federally related mortgage loan, including charges that the borrower and servicer have voluntarily agreed that the servicer should collect and pay. The definition encompasses any account established for this purpose, including a “trust account”, “reserve account”, “impound account”, or other term in different localities. An “escrow account” includes any arrangement where the servicer adds a portion of the borrower’s payments to principal and subsequently deducts from principal the disbursements for escrow account items. For purposes of this section, the term “escrow account” excludes any account that is under the borrower’s total control.

Escrow account analysis means the accounting that a servicer conducts in the form of a trial running balance for an escrow account to:

- (1) Determine the appropriate target balances;
- (2) Compute the borrower’s monthly payments for the next escrow account computation year and any deposits needed to establish or maintain the account; and
- (3) Determine whether shortages, surpluses or deficiencies exist.

Escrow account computation year is a 12-month period that a servicer establishes for the escrow account beginning with the borrower’s initial payment date. The term includes each 12-month period thereafter, unless a servicer chooses to issue a short year statement

§ 3500.17

24 CFR Ch. XX (4-1-11 Edition)

under the conditions stated in § 3500.17(i)(4).

Escrow account item or separate item means any separate expenditure category, such as “taxes” or “insurance”, for which funds are collected in the escrow account for disbursement. An escrow account item with installment payments, such as local property taxes, remains one escrow account item regardless of multiple disbursement dates to the tax authority.

Initial escrow account statement means the first disclosure statement that the servicer delivers to the borrower concerning the borrower’s escrow account. The initial escrow account statement shall meet the requirements of § 3500.17(g) and be in substantially the format set forth in § 3500.17(h).

Installment payment means one of two or more payments payable on an escrow account item during an escrow account computation year. An example of an installment payment is where a jurisdiction bills quarterly for taxes.

Payment due date means the date each month when the borrower’s monthly payment to an escrow account is due to the servicer. The initial payment date is the borrower’s first payment due date to an escrow account.

Penalty means a late charge imposed by the payee for paying after the disbursement is due. It does not include any additional charge or fee imposed by the payee associated with choosing installment payments as opposed to annual payments or for choosing one installment plan over another.

Pre-accrual is a practice some servicers use to require borrowers to deposit funds, needed for disbursement and maintenance of a cushion, in the escrow account some period before the disbursement date. Pre-accrual is subject to the limitations of § 3500.17(c).

Shortage means an amount by which a current escrow account balance falls short of the target balance at the time of escrow analysis.

Single-item analysis means an accounting method servicers use in conducting an escrow account analysis by computing the sufficiency of escrow account funds by considering each escrow item separately. Appendix E to this part sets forth examples of single-item analysis.

Submission (of an escrow account statement) means the delivery of the statement.

Surplus means an amount by which the current escrow account balance exceeds the target balance for the account.

System of recordkeeping means the servicer’s method of keeping information that reflects the facts relating to that servicer’s handling of the borrower’s escrow account, including, but not limited to, the payment of amounts from the escrow account and the submission of initial and annual escrow account statements to borrowers.

Target balance means the estimated month end balance in an escrow account that is just sufficient to cover the remaining disbursements from the escrow account in the escrow account computation year, taking into account the remaining scheduled periodic payments, and a cushion, if any.

Trial running balance means the accounting process that derives the target balances over the course of an escrow account computation year. Section 3500.17(d) provides a description of the steps involved in performing a trial running balance.

(c) *Limits on payments to escrow accounts.* (1) A lender or servicer (hereafter servicer) shall not require a borrower to deposit into any escrow account, created in connection with a federally related mortgage loan, more than the following amounts:

(i) *Charges at settlement or upon creation of an escrow account.* At the time a servicer creates an escrow account for a borrower, the servicer may charge the borrower an amount sufficient to pay the charges respecting the mortgaged property, such as taxes and insurance, which are attributable to the period from the date such payment(s) were last paid until the initial payment date. The “amount sufficient to pay” is computed so that the lowest month end target balance projected for the escrow account computation year is zero (–) (see Step 2 in appendix E to this part). In addition, the servicer may charge the borrower a cushion that shall be no greater than one-sixth ($\frac{1}{6}$) of the estimated total annual payments from the escrow account.

(ii) *Charges during the life of the escrow account.* Throughout the life of an escrow account, the servicer may charge the borrower a monthly sum equal to one-twelfth ($\frac{1}{12}$) of the total annual escrow payments which the servicer reasonably anticipates paying from the account. In addition, the servicer may add an amount to maintain a cushion no greater than one-sixth ($\frac{1}{6}$) of the estimated total annual payments from the account. However, if a servicer determines through an escrow account analysis that there is a shortage or deficiency, the servicer may require the borrower to pay additional deposits to make up the shortage or eliminate the deficiency, subject to the limitations set forth in §3500.17(f).

(2) *Escrow analysis at creation of escrow account.* Before establishing an escrow account, the servicer must conduct an escrow account analysis to determine the amount the borrower must deposit into the escrow account (subject to the limitations of paragraph (c)(1)(i) of this section), and the amount of the borrower's periodic payments into the escrow account (subject to the limitations of paragraph (c)(1)(ii) of this section). In conducting the escrow account analysis, the servicer must estimate the disbursement amounts according to paragraph (c)(7) of this section. Pursuant to paragraph (k) of this section, the servicer must use a date on or before the deadline to avoid a penalty as the disbursement date for the escrow item and comply with any other requirements of paragraph (k) of this section. Upon completing the initial escrow account analysis, the servicer must prepare and deliver an initial escrow account statement to the borrower, as set forth in paragraph (g) of this section. The servicer must use the escrow account analysis to determine whether a surplus, shortage, or deficiency exists and must make any adjustments to the account pursuant to paragraph (f) of this section.

(3) *Subsequent escrow account analyses.* For each escrow account, the servicer must conduct an escrow account analysis at the completion of the escrow account computation year to determine the borrower's monthly escrow

account payments for the next computation year, subject to the limitations of paragraph (c)(1)(ii) of this section. In conducting the escrow account analysis, the servicer must estimate the disbursement amounts according to paragraph (c)(7) of this section. Pursuant to paragraph (k) of this section, the servicer must use a date on or before the deadline to avoid a penalty as the disbursement date for the escrow item and comply with any other requirements of paragraph (k) of this section. The servicer must use the escrow account analysis to determine whether a surplus, shortage, or deficiency exists, and must make any adjustments to the account pursuant to paragraph (f) of this section. Upon completing an escrow account analysis, the servicer must prepare and submit an annual escrow account statement to the borrower, as set forth in paragraph (i) of this section.

(4) *Aggregate accounting required.* All servicers must use the aggregate accounting method in conducting escrow account analyses.

(5) *Cushion.* The cushion must be no greater than one-sixth ($\frac{1}{6}$) of the estimated total annual disbursements from the escrow account.

(6) *Restrictions on pre-accrual.* A servicer must not practice pre-accrual.

(7) *Servicer estimates of disbursement amounts.* To conduct an escrow account analysis, the servicer shall estimate the amount of escrow account items to be disbursed. If the servicer knows the charge for an escrow item in the next computation year, then the servicer shall use that amount in estimating disbursement amounts. If the charge is unknown to the servicer, the servicer may base the estimate on the preceding year's charge, or the preceding year's charge as modified by an amount not exceeding the most recent year's change in the national Consumer Price Index for all urban consumers (CPI, all items). In cases of unassessed new construction, the servicer may base an estimate on the assessment of comparable residential property in the market area.

(8) *Provisions in mortgage documents.* The servicer must examine the mortgage loan documents to determine the

§ 3500.17

24 CFR Ch. XX (4-1-11 Edition)

applicable cushion for each escrow account. If the mortgage loan documents provide for lower cushion limits, then the terms of the loan documents apply. Where the terms of any mortgage loan document allow greater payments to an escrow account than allowed by this section, then this section controls the applicable limits. Where the mortgage loan documents do not specifically establish an escrow account, whether a servicer may establish an escrow account for the loan is a matter for determination by other Federal or State law. If the mortgage loan document is silent on the escrow account limits and a servicer establishes an escrow account under other Federal or State law, then the limitations of this section apply unless applicable Federal or State law provides for a lower amount. If the loan documents provide for escrow accounts up to the RESPA limits, then the servicer may require the maximum amounts consistent with this section, unless an applicable Federal or State law sets a lesser amount.

(9) *Assessments for periods longer than one year.* Some escrow account items may be billed for periods longer than one year. For example, servicers may need to collect flood insurance or water purification escrow funds for payment every three years. In such cases, the servicer shall estimate the borrower's payments for a full cycle of disbursements. For a flood insurance premium payable every 3 years, the servicer shall collect the payments reflecting 36 equal monthly amounts. For two out of the three years, however, the account balance may not reach its low monthly balance because the low point will be on a three-year cycle, as compared to an annual one. The annual escrow account statement shall explain this situation (see example in the HUD Public Guidance Document entitled "Annual Escrow Account Disclosure Statement—Example", available in accordance with §3500.3).

(d) *Methods of escrow account analysis.* (1) The following sets forth the steps servicers must use to determine whether their use of aggregate analysis conforms with the limitations in §3500.17(c)(1). The steps set forth in this section result in maximum limits. Servicers may use accounting proce-

dures that result in lower target balances. In particular, servicers may use a cushion less than the permissible cushion or no cushion at all. This section does not require the use of a cushion.

(2) *Aggregate analysis.* (i) In conducting the escrow account analysis using aggregate analysis, the target balances may not exceed the balances computed according to the following arithmetic operations:

(A) The servicer first projects a trial balance for the account as a whole over the next computation year (a trial running balance). In doing so the servicer assumes that it will make estimated disbursements on or before the earlier of the deadline to take advantage of discounts, if available, or the deadline to avoid a penalty. The servicer does not use pre-accrual on these disbursement dates. The servicer also assumes that the borrower will make monthly payments equal to one-twelfth of the estimated total annual escrow account disbursements.

(B) The servicer then examines the monthly trial balances and adds to the first monthly balance an amount just sufficient to bring the lowest monthly trial balance to zero, and adjusts all other monthly balances accordingly.

(C) The servicer then adds to the monthly balances the permissible cushion. The cushion is two months of the borrower's escrow payments to the servicer or a lesser amount specified by State law or the mortgage document (net of any increases or decreases because of prior year shortages or surpluses, respectively).

(ii) *Lowest monthly balance.* Under aggregate analysis, the lowest monthly target balance for the account shall be less than or equal to one-sixth of the estimated total annual escrow account disbursements or a lesser amount specified by State law or the mortgage document. The target balances that the servicer derives using these steps yield the maximum limit for the escrow account. Appendix E to this part illustrates these steps.

(e) *Transfer of servicing.* (1) If the new servicer changes either the monthly payment amount or the accounting method used by the transferor (old) servicer, then the new servicer shall

provide the borrower with an initial escrow account statement within 60 days of the date of servicing transfer.

(i) Where a new servicer provides an initial escrow account statement upon the transfer of servicing, the new servicer shall use the effective date of the transfer of servicing to establish the new escrow account computation year.

(ii) Where the new servicer retains the monthly payments and accounting method used by the transferor servicer, then the new servicer may continue to use the escrow account computation year established by the transferor servicer or may choose to establish a different computation year using a short-year statement. At the completion of the escrow account computation year or any short year, the new servicer shall perform an escrow analysis and provide the borrower with an annual escrow account statement.

(2) The new servicer shall treat shortages, surpluses and deficiencies in the transferred escrow account according to the procedures set forth in §3500.17(f).

(f) *Shortages, surpluses, and deficiencies requirements*—(1) *Escrow account analysis.* For each escrow account, the servicer shall conduct an escrow account analysis to determine whether a surplus, shortage or deficiency exists.

(i) As noted in §3500.17(c)(2) and (3), the servicer shall conduct an escrow account analysis upon establishing an escrow account and at completion of the escrow account computation year.

(ii) The servicer may conduct an escrow account analysis at other times during the escrow computation year. If a servicer advances funds in paying a disbursement, which is not the result of a borrower's payment default under the underlying mortgage document, then the servicer shall conduct an escrow account analysis to determine the extent of the deficiency before seeking repayment of the funds from the borrower under this paragraph (f).

(2) *Surpluses.* (i) If an escrow account analysis discloses a surplus, the servicer shall, within 30 days from the date of the analysis, refund the surplus to the borrower if the surplus is greater than or equal to 50 dollars (\$50). If the surplus is less than 50 dollars (\$50),

the servicer may refund such amount to the borrower, or credit such amount against the next year's escrow payments.

(ii) These provisions regarding surpluses apply if the borrower is current at the time of the escrow account analysis. A borrower is current if the servicer receives the borrower's payments within 30 days of the payment due date. If the servicer does not receive the borrower's payment within 30 days of the payment due date, then the servicer may retain the surplus in the escrow account pursuant to the terms of the mortgage loan documents.

(iii) After an initial or annual escrow analysis has been performed, the servicer and the borrower may enter into a voluntary agreement for the forthcoming escrow accounting year for the borrower to deposit funds into the escrow account for that year greater than the limits established under paragraph (c) of this section. Such an agreement shall cover only one escrow accounting year, but a new voluntary agreement may be entered into after the next escrow analysis is performed. The voluntary agreement may not alter how surpluses are to be treated when the next escrow analysis is performed at the end of the escrow accounting year covered by the voluntary agreement.

(3) *Shortages.* (i) If an escrow account analysis discloses a shortage of less than one month's escrow account payment, then the servicer has three possible courses of action:

(A) The servicer may allow a shortage to exist and do nothing to change it;

(B) The servicer may require the borrower to repay the shortage amount within 30 days; or

(C) The servicer may require the borrower to repay the shortage amount in equal monthly payments over at least a 12-month period.

(ii) If an escrow account analysis discloses a shortage that is greater than or equal to one month's escrow account payment, then the servicer has two possible courses of action:

(A) The servicer may allow a shortage to exist and do nothing to change it; or

§ 3500.17

24 CFR Ch. XX (4-1-11 Edition)

(B) The servicer may require the borrower to repay the shortage in equal monthly payments over at least a 12-month period.

(4) *Deficiency.* If the escrow account analysis confirms a deficiency, then the servicer may require the borrower to pay additional monthly deposits to the account to eliminate the deficiency.

(i) If the deficiency is less than one month's escrow account payment, then the servicer:

(A) May allow the deficiency to exist and do nothing to change it;

(B) May require the borrower to repay the deficiency within 30 days; or

(C) May require the borrower to repay the deficiency in 2 or more equal monthly payments.

(ii) If the deficiency is greater than or equal to 1 month's escrow payment, the servicer may allow the deficiency to exist and do nothing to change it or may require the borrower to repay the deficiency in two or more equal monthly payments.

(iii) These provisions regarding deficiencies apply if the borrower is current at the time of the escrow account analysis. A borrower is current if the servicer receives the borrower's payments within 30 days of the payment due date. If the servicer does not receive the borrower's payment within 30 days of the payment due date, then the servicer may recover the deficiency pursuant to the terms of the mortgage loan documents.

(5) *Notice of shortage or deficiency in escrow account.* The servicer shall notify the borrower at least once during the escrow account computation year if there is a shortage or deficiency in the escrow account. The notice may be part of the annual escrow account statement or it may be a separate document.

(g) *Initial escrow account statement.* (1) Submission at settlement, or within 45 calendar days of settlement. As noted in §3500.17(c)(2), the servicer shall conduct an escrow account analysis before establishing an escrow account to determine the amount the borrower shall deposit into the escrow account, subject to the limitations of §3500.17(c)(1)(i). After conducting the escrow account analysis for each es-

crow account, the servicer shall submit an initial escrow account statement to the borrower at settlement or within 45 calendar days of settlement for escrow accounts that are established as a condition of the loan.

(i) The initial escrow account statement shall include the amount of the borrower's monthly mortgage payment and the portion of the monthly payment going into the escrow account and shall itemize the estimated taxes, insurance premiums, and other charges that the servicer reasonably anticipates to be paid from the escrow account during the escrow account computation year and the anticipated disbursement dates of those charges. The initial escrow account statement shall indicate the amount that the servicer selects as a cushion. The statement shall include a trial running balance for the account.

(ii) Pursuant to §3500.17(h)(2), the servicer may incorporate the initial escrow account statement into the HUD-1 or HUD-1A settlement statement. If the servicer does not incorporate the initial escrow account statement into the HUD-1 or HUD-1A settlement statement, then the servicer shall submit the initial escrow account statement to the borrower as a separate document.

(2) *Time of submission of initial escrow account statement for an escrow account established after settlement.* For escrow accounts established after settlement (and which are not a condition of the loan), a servicer shall submit an initial escrow account statement to a borrower within 45 calendar days of the date of establishment of the escrow account.

(h) *Format for initial escrow account statement.* (1) The format and a completed example for an initial escrow account statement are set out in HUD Public Guidance Documents entitled "Initial Escrow Account Disclosure Statement—Format" and "Initial Escrow Account Disclosure Statement—Example", available in accordance with §3500.3.

(2) *Incorporation of initial escrow account statement into HUD-1 or HUD-1A settlement statement.* Pursuant to §3500.9(a)(11), a servicer may add the initial escrow account statement to

the HUD-1 or HUD-1A settlement statement. The servicer may include the initial escrow account statement in the basic text or may attach the initial escrow account statement as an additional page to the HUD-1 or HUD-1A settlement statement.

(3) *Identification of payees.* The initial escrow account statement need not identify a specific payee by name if it provides sufficient information to identify the use of the funds. For example, appropriate entries include: county taxes, hazard insurance, condominium dues, etc. If a particular payee, such as a taxing body, receives more than one payment during the escrow account computation year, the statement shall indicate each payment and disbursement date. If there are several taxing authorities or insurers, the statement shall identify each taxing body or insurer (e.g., "City Taxes", "School Taxes", "Hazard Insurance", or "Flood Insurance," etc.).

(i) *Annual escrow account statements.* For each escrow account, a servicer shall submit an annual escrow account statement to the borrower within 30 days of the completion of the escrow account computation year. The servicer shall also submit to the borrower the previous year's projection or initial escrow account statement. The servicer shall conduct an escrow account analysis before submitting an annual escrow account statement to the borrower.

(1) *Contents of annual escrow account statement.* The annual escrow account statement shall provide an account history, reflecting the activity in the escrow account during the escrow account computation year, and a projection of the activity in the account for the next year. In preparing the statement, the servicer may assume scheduled payments and disbursements will be made for the final 2 months of the escrow account computation year. The annual escrow account statement must include, at a minimum, the following (the items in paragraphs (i)(1)(i) through (i)(1)(iv) must be clearly itemized):

(i) The amount of the borrower's current monthly mortgage payment and the portion of the monthly payment going into the escrow account;

(ii) The amount of the past year's monthly mortgage payment and the portion of the monthly payment that went into the escrow account;

(iii) The total amount paid into the escrow account during the past computation year;

(iv) The total amount paid out of the escrow account during the same period for taxes, insurance premiums, and other charges (as separately identified);

(v) The balance in the escrow account at the end of the period;

(vi) An explanation of how any surplus is being handled by the servicer;

(vii) An explanation of how any shortage or deficiency is to be paid by the borrower; and

(viii) If applicable, the reason(s) why the estimated low monthly balance was not reached, as indicated by noting differences between the most recent account history and last year's projection. HUD Public Guidance Documents entitled "Annual Escrow Account Disclosure Statement—Format" and "Annual Escrow Account Disclosure Statement—Example" set forth an acceptable format and methodology for conveying this information.

(2) *No annual statements in the case of default, foreclosure, or bankruptcy.* This paragraph (i)(2) contains an exemption from the provisions of §3500.17(i)(1). If at the time the servicer conducts the escrow account analysis the borrower is more than 30 days overdue, then the servicer is exempt from the requirements of submitting an annual escrow account statement to the borrower under §3500.17(i). This exemption also applies in situations where the servicer has brought an action for foreclosure under the underlying mortgage loan, or where the borrower is in bankruptcy proceedings. If the servicer does not issue an annual statement pursuant to this exemption and the loan subsequently is reinstated or otherwise becomes current, the servicer shall provide a history of the account since the last annual statement (which may be longer than 1 year) within 90 days of the date the account became current.

(3) *Delivery with other material.* The servicer may deliver the annual escrow account statement to the borrower

with other statements or materials, including the Substitute 1098, which is provided for federal income tax purposes.

(4) *Short year statements.* A servicer may issue a short year annual escrow account statement (“short year statement”) to change one escrow account computation year to another. By using a short year statement a servicer may adjust its production schedule or alter the escrow account computation year for the escrow account.

(i) *Effect of short year statement.* The short year statement shall end the “escrow account computation year” for the escrow account and establish the beginning date of the new escrow account computation year. The servicer shall deliver the short year statement to the borrower within 60 days from the end of the short year.

(ii) *Short year statement upon servicing transfer.* Upon the transfer of servicing, the transferor (old) servicer shall submit a short year statement to the borrower within 60 days of the effective date of transfer.

(iii) *Short year statement upon loan payoff.* If a borrower pays off a mortgage loan during the escrow account computation year, the servicer shall submit a short year statement to the borrower within 60 days after receiving the pay-off funds.

(j) *Formats for annual escrow account statement.* The formats and completed examples for annual escrow account statements using single-item analysis (pre-rule accounts) and aggregate analysis are set out in HUD Public Guidance Documents entitled “Annual Escrow Account Disclosure Statement—Format” and “Annual Escrow Account Disclosure Statement—Example”.

(k) *Timely payments.* (1) If the terms of any federally related mortgage loan require the borrower to make payments to an escrow account, the servicer must pay the disbursements in a timely manner, that is, on or before the deadline to avoid a penalty, as long as the borrower’s payment is not more than 30 days overdue.

(2) The servicer must advance funds to make disbursements in a timely manner as long as the borrower’s payment is not more than 30 days overdue. Upon advancing funds to pay a dis-

bursalment, the servicer may seek repayment from the borrower for the deficiency pursuant to paragraph (f) of this section.

(3) For the payment of property taxes from the escrow account, if a taxing jurisdiction offers a servicer a choice between annual and installment disbursements, the servicer must also comply with this paragraph (k)(3). If the taxing jurisdiction neither offers a discount for disbursements on a lump sum annual basis nor imposes any additional charge or fee for installment disbursements, the servicer must make disbursements on an installment basis. If, however, the taxing jurisdiction offers a discount for disbursements on a lump sum annual basis or imposes any additional charge or fee for installment disbursements, the servicer may at the servicer’s discretion (but is not required by RESPA to), make lump sum annual disbursements in order to take advantage of the discount for the borrower or avoid the additional charge or fee for installments, as long as such method of disbursement complies with paragraphs (k)(1) and (k)(2) of this section. HUD encourages, but does not require, the servicer to follow the preference of the borrower, if such preference is known to the servicer.

(4) Notwithstanding paragraph (k)(3) of this section, a servicer and borrower may mutually agree, on an individual case basis, to a different disbursement basis (installment or annual) or disbursement date for property taxes from that required under paragraph (k)(3) of this section, so long as the agreement meets the requirements of paragraphs (k)(1) and (k)(2) of this section. The borrower must voluntarily agree; neither loan approval nor any term of the loan may be conditioned on the borrower’s agreeing to a different disbursement basis or disbursement date.

(1) *System of recordkeeping.* (1) Each servicer shall keep records, which may involve electronic storage, microfiche storage, or any method of computerized storage, so long as the information is easily retrievable, reflecting the servicer’s handling of each borrower’s escrow account. The servicer’s records shall include, but not be limited to, the payment of amounts into and from the escrow account and the submission of

initial and annual escrow account statements to the borrower.

(2) The servicer responsible for servicing the borrower's escrow account shall maintain the records for that account for a period of at least five years after the servicer last serviced the escrow account.

(3) A servicer shall provide the Secretary with information contained in the servicer's records for a specific escrow account, or for a number or class of escrow accounts, within 30 days of the Secretary's written request for the information. The servicer shall convert any information contained in electronic storage, microfiche or computerized storage to paper copies for review by the Secretary.

(i) To aid in investigations, the Secretary may also issue an administrative subpoena for the production of documents, and for the testimony of such witnesses as the Secretary deems advisable.

(ii) If the subpoenaed party refuses to obey the Secretary's administrative subpoena, the Secretary is authorized to seek a court order requiring compliance with the subpoena from any United States district court. Failure to obey such an order of the court may be punished as contempt of court.

(4) Borrowers may seek information contained in the servicer's records by complying with the provisions set forth in 12 U.S.C. 2605(e) and § 3500.21(f).

(5) After receiving a request (by letter or subpoena) from the Department for information relating to whether a servicer submitted an escrow account statement to the borrower, the servicer shall respond within 30 days. If the servicer is unable to provide the Department with such information, the Secretary shall deem that lack of information to be evidence of the servicer's failure to submit the statement to the borrower.

(m) *Penalties.* (1) A servicer's failure to submit to a borrower an initial or annual escrow account statement meeting the requirements of this part shall constitute a violation of section 10(d) of RESPA (12 U.S.C. 2609(d)) and this section. For each such violation, the Secretary shall assess a civil penalty of 75 dollars (\$75), except that the total of the assessed penalties shall not

exceed \$130,000 for any one servicer for violations that occur during any consecutive 12-month period.

(2) Violations described in paragraph (m)(1) of this section do not require any proof of intent. However, if a lender or servicer is shown to have intentionally disregarded the requirements that it submit the escrow account statement to the borrower, then the Secretary shall assess a civil penalty of \$110 for each violation, with no limit on the total amount of the penalty.

(n) *Civil penalties procedures.* The following procedures shall apply whenever the Department seeks to impose a civil money penalty for violation of section 10(c) of RESPA (12 U.S.C. 2609(c)):

(1) *Purpose and scope.* This paragraph (n) explains the procedures by which the Secretary may impose penalties under 12 U.S.C. 2609(d). These procedures include administrative hearings, judicial review, and collection of penalties. This paragraph (n) governs penalties imposed under 12 U.S.C. 2609(d) and, when noted, adopts those portions of 24 CFR part 30 that apply to all other civil penalty proceedings initiated by the Secretary.

(2) *Authority.* The Secretary has the authority to impose civil penalties under section 10(d) of RESPA (12 U.S.C. 2609(d)).

(3) *Notice of intent to impose civil money penalties.* Whenever the Secretary intends to impose a civil money penalty for violations of section 10(c) of RESPA (12 U.S.C. 2609(c)), the responsible program official, or his or her designee, shall serve a written Notice of Intent to Impose Civil Money Penalties (Notice of Intent) upon any servicer on which the Secretary intends to impose the penalty. A copy of the Notice of Intent must be filed with the Docket Clerk, Office of Administrative Law Judges, at the address provided in the Notice of Intent. The Notice of Intent will provide:

(i) A short, plain statement of the facts upon which the Secretary has determined that a civil money penalty should be imposed, including a brief description of the specific violations under 12 U.S.C. 2609(c) with which the servicer is charged and whether such

violations are believed to be intentional or unintentional in nature, or a combination thereof;

(ii) The amount of the civil money penalty that the Secretary intends to impose and whether the limitations in 12 U.S.C. 2609(d)(1), apply;

(iii) The right of the servicer to a hearing on the record to appeal the Secretary's preliminary determination to impose a civil penalty;

(iv) The procedures to appeal the penalty;

(v) The consequences of failure to appeal the penalty; and

(vi) The name, address, and telephone number of the representative of the Department, and the address of the Docket Clerk, Office of Administrative Law Judges, should the servicer decide to appeal the penalty.

(4) *Appeal procedures.* (i) *Answer.* To appeal the imposition of a penalty, a servicer shall, within 30 days after receiving service of the Notice of Intent, file a written Answer with the Docket Clerk, Office of Administrative Law Judges, Department of Housing and Urban Development, at the address provided in the Notice of Intent. The Answer shall include a statement that the servicer admits, denies, or does not have (and is unable to obtain) sufficient information to admit or deny each allegation made in the Notice of Intent. A statement of lack of information shall have the effect of a denial. Any allegation that is not denied shall be deemed admitted. Failure to submit an Answer within the required period of time will result in a decision by the Administrative Law Judge based upon the Department's submission of evidence in the Notice of Intent.

(ii) *Submission of evidence.* A servicer that receives the Notice of Intent has a right to present evidence. Evidence must be submitted within 45 calendar days from the date of service of the Notice of Intent, or by such other time as may be established by the Administrative Law Judge (ALJ). The servicer's failure to submit evidence within the required period of time will result in a decision by the Administrative Law Judge based upon the Department's submission of evidence in the Notice of Intent. The servicer may present evidence of the following:

(A) The servicer did submit the required escrow account statement(s) to the borrower(s); or

(B) Even if the servicer did not submit the required statement(s), that the failure was not the result of an intentional disregard of the requirements of RESPA (for purposes of determining the penalty).

(iii) *Review of the record.* The Administrative Law Judge will review the evidence submitted by the servicer, if any, and that submitted by the Department. The Administrative Law Judge shall make a determination based upon a review of the written record, except that the Administrative Law Judge may order an oral hearing if he or she finds that the determination turns on the credibility or veracity of a witness, or that the matter cannot be resolved by review of the documentary evidence. If the Administrative Law Judge decides that an oral hearing is appropriate, then the procedural rules set forth at 24 CFR part 30 shall apply, to the extent that they are not inconsistent with this section.

(iv) *Burden of proof.* The burden of proof or the burden of going forward with the evidence shall be upon the proponent of an action. The Department's submission of evidence that the servicer's system of records lacks information that the servicer submitted the escrow account statement(s) to the borrower(s) shall satisfy the Department's burden. Upon the Department's presentation of evidence of this lack of information in the servicer's system of records, the burden of proof shifts from the Secretary to the servicer to provide evidence that it submitted the statement(s) to the borrower.

(v) *Standard of proof.* The standard of proof shall be the preponderance of the evidence.

(5) *Determination of the Administrative Law Judge.* (i) Following the hearing or the review of the written record, the Administrative Law Judge shall issue a decision that shall contain findings of fact, conclusions of law, and the amount of any penalties imposed. The decision shall include a determination of whether the servicer has failed to submit any required statements and, if so, whether the servicer's failure was

the result of an intentional disregard for the law's requirements.

(ii) The Administrative Law Judge shall issue the decision to all parties within 30 days of the submission of the evidence or the post-hearing briefs, whichever is the last to occur.

(iii) The decision of the Administrative Law Judge shall constitute the final decision of the Department and shall be final and binding on the parties.

(6) *Judicial review.* (i) A person against whom the Department has imposed a civil money penalty under this part may obtain a review of the Department's final decision by filing a written petition for a review of the record with the appropriate United States district court.

(ii) The petition must be filed within 30 days after the decision is filed with the Docket Clerk, Office of Administrative Law Judges.

(7) *Collection of penalties.* (i) If any person fails to comply with the Department's final decision imposing a civil money penalty, the Secretary, if the time for judicial review of the decision has expired, may request the Attorney General to bring an action in an appropriate United States district court to obtain a judgment against the person that has failed to comply with the Department's final decision.

(ii) In any such collection action, the validity and appropriateness of the Department's final decision imposing the civil penalty shall not be subject to review in the district court.

(iii) The Secretary may obtain such other relief as may be available, including attorney fees and other expenses in connection with the collection action.

(iv) Interest on and other charges for any unpaid penalty may be assessed in accordance with 31 U.S.C. 3717.

(8) *Offset.* In addition to any other rights as a creditor, the Secretary may seek to collect a civil money penalty through administrative offset.

(9) At any time before the decision of the Administrative Law Judge, the Secretary and the servicer may enter into an administrative settlement. The settlement may include provisions for interest, attorney's fees, and costs related to the proceeding. Such settle-

ment will terminate the appearance before the Administrative Law Judge.

(o) *Discretionary payments.* Any borrower's discretionary payment (such as credit life or disability insurance) made as part of a monthly mortgage payment is to be noted on the initial and annual statements. If a discretionary payment is established or terminated during the escrow account computation year, this change should be noted on the next annual statement. A discretionary payment is not part of the escrow account unless the payment is required by the lender, in accordance with the definition of "settlement service" in § 3500.2, or the servicer chooses to place the discretionary payment in the escrow account. If a servicer has not established an escrow account for a federally related mortgage loan and only receives payments for discretionary items, this section is not applicable.

(Approved by the Office of Management and Budget under control number 2502-0501)

[61 FR 13233, Mar. 26, 1996, as amended at 61 FR 46510, Sept. 3, 1996; 61 FR 50219, Sept. 24, 1996; 61 FR 58476, Nov. 15, 1996; 63 FR 3236, Jan. 21, 1998; 68 FR 12789, Mar. 17, 2003; 72 FR 5589, Feb. 6, 2007; 73 FR 68242, Nov. 17, 2008; 74 FR 4636, Jan. 26, 2009]

§ 3500.18 Validity of contracts and liens.

Section 17 of RESPA (12 U.S.C. 2615) governs the validity of contracts and liens under RESPA.

§ 3500.19 Enforcement.

(a) *Enforcement policy.* It is the policy of the Secretary regarding RESPA enforcement matters to cooperate with Federal, State, or local agencies having supervisory powers over lenders or other persons with responsibilities under RESPA. Federal agencies with supervisory powers over lenders may use their powers to require compliance with RESPA. In addition, failure to comply with RESPA may be grounds for administrative action by the Secretary under 2 CFR part 2424 concerning debarment, suspension, ineligibility of contractors and grantees, or under part 25 of this title concerning the HUD Mortgagee Review Board.

§ 3500.20

Nothing in this paragraph is a limitation on any other form of enforcement that may be legally available.

(b) *Violations of section 8 of RESPA (12 U.S.C. 2607), § 3500.14, or § 3500.15.* Any person who violates §§ 3500.14 or 3500.15 shall be deemed to violate section 8 of RESPA and shall be sanctioned accordingly.

(c) *Violations of section 9 of RESPA (12 U.S.C. 2608) or § 3500.16.* Any person who violates section 3500.16 of this part shall be deemed to violate section 9 of RESPA and shall be sanctioned accordingly.

(d) *Investigations.* The procedures for investigations and investigational proceedings are set forth in 24 CFR part 3800.

[61 FR 13233, Mar. 26, 1996, as amended at 72 FR 73497, Dec. 27, 2007]

§ 3500.20 [Reserved]

§ 3500.21 Mortgage servicing transfers.

(a) *Definitions.* As used in this section:

Master servicer means the owner of the right to perform servicing, which may actually perform the servicing itself or may do so through a subservicer.

Mortgage servicing loan means a federally related mortgage loan, as that term is defined in § 3500.2, subject to the exemptions in § 3500.5, when the mortgage loan is secured by a first lien. The definition does not include subordinate lien loans or open-end lines of credit (home equity plans) covered by the Truth in Lending Act and Regulation Z, including open-end lines of credit secured by a first lien.

Qualified written request means a written correspondence from the borrower to the servicer prepared in accordance with paragraph (e)(2) of this section.

Subservicer means a servicer who does not own the right to perform servicing, but who does so on behalf of the master servicer.

Transferee servicer means a servicer who obtains or who will obtain the right to perform servicing functions pursuant to an agreement or understanding.

Transferor servicer means a servicer, including a table funding mortgage broker or dealer on a first lien dealer

24 CFR Ch. XX (4–1–11 Edition)

loan, who transfers or will transfer the right to perform servicing functions pursuant to an agreement or understanding.

(b) *Servicing Disclosure Statement; Requirements.* (1) At the time an application for a mortgage servicing loan is submitted, or within 3 business days after submission of the application, the lender, mortgage broker who anticipates using table funding, or dealer who anticipates a first lien dealer loan shall provide to each person who applies for such a loan a Servicing Disclosure Statement. A format for the Servicing Disclosure Statement appears as Appendix MS-1 to this part. The specific language of the Servicing Disclosure Statement is not required to be used. The information set forth in “Instructions to Preparer” on the Servicing Disclosure Statement need not be included with the information given to applicants, and material in square brackets is optional or alternative language. The model format may be annotated with additional information that clarifies or enhances the model language. The lender, table funding mortgage broker, or dealer should use the language that best describes the particular circumstances.

(2) The Servicing Disclosure Statement must indicate whether the servicing of the loan may be assigned, sold, or transferred to any other person at any time while the loan is outstanding. If the lender, table funding mortgage broker, or dealer in a first lien dealer loan will engage in the servicing of the mortgage loan for which the applicant has applied, the disclosure may consist of a statement that the entity will service such loan and does not intend to sell, transfer, or assign the servicing of the loan. If the lender, table funding mortgage broker, or dealer in a first lien dealer loan will not engage in the servicing of the mortgage loan for which the applicant has applied, the disclosure may consist of a statement that such entity intends to assign, sell, or transfer servicing of such mortgage loan before the first payment is due. In all other instances, the disclosure must state that the servicing of the loan may be assigned, sold or transferred while the loan is outstanding.

(c) *Servicing Disclosure Statement; Delivery.* The lender, table funding mortgage broker, or dealer that anticipates a first lien dealer loan shall deliver the Servicing Disclosure Statement within 3 business days from receipt of the application by hand delivery, by placing it in the mail, or, if the applicant agrees, by fax, e-mail, or other electronic means. In the event the borrower is denied credit within the 3 business-day period, no servicing disclosure statement is required to be delivered. If co-applicants indicate the same address on their application, one copy delivered to that address is sufficient. If different addresses are shown by co-applicants on the application, a copy must be delivered to each of the co-applicants.

(d) *Notices of Transfer; loan servicing—*
 (1) *Requirement for notice.* (i) Except as provided in this paragraph (d)(1)(i) or paragraph (d)(1)(ii) of this section, each transferor servicer and transferee servicer of any mortgage servicing loan shall deliver to the borrower a written Notice of Transfer, containing the information described in paragraph (d)(3) of this section, of any assignment, sale, or transfer of the servicing of the loan. The following transfers are not considered an assignment, sale, or transfer of mortgage loan servicing for purposes of this requirement if there is no change in the payee, address to which payment must be delivered, account number, or amount of payment due:

- (A) Transfers between affiliates;
- (B) Transfers resulting from mergers or acquisitions of servicers or subservicers; and
- (C) Transfers between master servicers, where the subservicer remains the same.

(ii) The Federal Housing Administration (FHA) is not required under paragraph (d) of this section to submit to the borrower a Notice of Transfer in cases where a mortgage insured under the National Housing Act is assigned to FHA.

(2) *Time of notice.* (i) Except as provided in paragraph (d)(2)(ii) of this section:

- (A) The transferor servicer shall deliver the Notice of Transfer to the borrower not less than 15 days before the effective date of the transfer of the

servicing of the mortgage servicing loan;

(B) The transferee servicer shall deliver the Notice of Transfer to the borrower not more than 15 days after the effective date of the transfer; and

(C) The transferor and transferee servicers may combine their notices into one notice, which shall be delivered to the borrower not less than 15 days before the effective date of the transfer of the servicing of the mortgage servicing loan.

(ii) The Notice of Transfer shall be delivered to the borrower by the transferor servicer or the transferee servicer not more than 30 days after the effective date of the transfer of the servicing of the mortgage servicing loan in any case in which the transfer of servicing is preceded by:

(A) Termination of the contract for servicing the loan for cause;

(B) Commencement of proceedings for bankruptcy of the servicer; or

(C) Commencement of proceedings by the Federal Deposit Insurance Corporation (FDIC) or the Resolution Trust Corporation (RTC) for conservatorship or receivership of the servicer or an entity that owns or controls the servicer.

(iii) Notices of Transfer delivered at settlement by the transferor servicer and transferee servicer, whether as separate notices or as a combined notice, will satisfy the timing requirements of paragraph (d)(2) of this section.

(3) *Notices of Transfer; contents.* The Notices of Transfer required under paragraph (d) of this section shall include the following information:

(i) The effective date of the transfer of servicing;

(ii) The name, consumer inquiry addresses (including, at the option of the servicer, a separate address where qualified written requests must be sent), and a toll-free or collect-call telephone number for an employee or department of the transferee servicer;

(iii) A toll-free or collect-call telephone number for an employee or department of the transferor servicer that can be contacted by the borrower for answers to servicing transfer inquiries;

(iv) The date on which the transferor servicer will cease to accept payments relating to the loan and the date on

which the transferee servicer will begin to accept such payments. These dates shall either be the same or consecutive days;

(v) Information concerning any effect the transfer may have on the terms or the continued availability of mortgage life or disability insurance, or any other type of optional insurance, and any action the borrower must take to maintain coverage;

(vi) A statement that the transfer of servicing does not affect any other term or condition of the mortgage documents, other than terms directly related to the servicing of the loan; and

(vii) A statement of the borrower's rights in connection with complaint resolution, including the information set forth in paragraph (e) of this section. Appendix MS-2 of this part illustrates a statement satisfactory to the Secretary.

(4) *Notices of Transfer; sample notice.* Sample language that may be used to comply with the requirements of paragraph (d) of this section is set out in appendix MS-2 of this part. Minor modifications to the sample language may be made to meet the particular circumstances of the servicer, but the substance of the sample language shall not be omitted or substantially altered.

(5) *Consumer protection during transfer of servicing.* During the 60-day period beginning on the effective date of transfer of the servicing of any mortgage servicing loan, if the transferor servicer (rather than the transferee servicer that should properly receive payment on the loan) receives payment on or before the applicable due date (including any grace period allowed under the loan documents), a late fee may not be imposed on the borrower with respect to that payment and the payment may not be treated as late for any other purposes.

(e) *Duty of loan servicer to respond to borrower inquiries*—(1) *Notice of receipt of inquiry.* Within 20 business days of a servicer of a mortgage servicing loan receiving a qualified written request from the borrower for information relating to the servicing of the loan, the servicer shall provide to the borrower a written response acknowledging receipt of the qualified written response.

This requirement shall not apply if the action requested by the borrower is taken within that period and the borrower is notified of that action in accordance with the paragraph (f)(3) of this section. By notice either included in the Notice of Transfer or separately delivered by first-class mail, postage prepaid, a servicer may establish a separate and exclusive office and address for the receipt and handling of qualified written requests.

(2) *Qualified written request; defined.* (i) For purposes of paragraph (e) of this section, a qualified written request means a written correspondence (other than notice on a payment coupon or other payment medium supplied by the servicer) that includes, or otherwise enables the servicer to identify, the name and account of the borrower, and includes a statement of the reasons that the borrower believes the account is in error, if applicable, or that provides sufficient detail to the servicer regarding information relating to the servicing of the loan sought by the borrower.

(ii) A written request does not constitute a qualified written request if it is delivered to a servicer more than 1 year after either the date of transfer of servicing or the date that the mortgage servicing loan amount was paid in full, whichever date is applicable.

(3) *Action with respect to the inquiry.* Not later than 60 business days after receiving a qualified written request from the borrower, and, if applicable, before taking any action with respect to the inquiry, the servicer shall:

(i) Make appropriate corrections in the account of the borrower, including the crediting of any late charges or penalties, and transmit to the borrower a written notification of the correction. This written notification shall include the name and telephone number of a representative of the servicer who can provide assistance to the borrower; or

(ii) After conducting an investigation, provide the borrower with a written explanation or clarification that includes:

(A) To the extent applicable, a statement of the servicer's reasons for concluding the account is correct and the

name and telephone number of an employee, office, or department of the servicer that can provide assistance to the borrower; or

(B) Information requested by the borrower, or an explanation of why the information requested is unavailable or cannot be obtained by the servicer, and the name and telephone number of an employee, office, or department of the servicer that can provide assistance to the borrower.

(4) *Protection of credit rating.* (i) During the 60-business day period beginning on the date of the servicer receiving from a borrower a qualified written request relating to a dispute on the borrower's payments, a servicer may not provide adverse information regarding any payment that is the subject of the qualified written request to any consumer reporting agency (as that term is defined in section 603 of the Fair Credit Reporting Act, 15 U.S.C. 1681a).

(ii) In accordance with section 17 of RESPA (12 U.S.C. 2615), the protection of credit rating provision of paragraph (e)(4)(i) of this section does not impede a lender or servicer from pursuing any of its remedies, including initiating foreclosure, allowed by the underlying mortgage loan instruments.

(f) *Damages and costs.* (1) Whoever fails to comply with any provision of this section shall be liable to the borrower for each failure in the following amounts:

(i) *Individuals.* In the case of any action by an individual, an amount equal to the sum of any actual damages sustained by the individual as the result of the failure and, when there is a pattern or practice of noncompliance with the requirements of this section, any additional damages in an amount not to exceed \$1,000.

(ii) *Class actions.* In the case of a class action, an amount equal to the sum of any actual damages to each borrower in the class that result from the failure and, when there is a pattern or practice of noncompliance with the requirements of this section, any additional damages in an amount not greater than \$1,000 for each class member. However, the total amount of any additional damages in a class action may not exceed the lesser of \$500,000 or 1

percent of the net worth of the servicer.

(iii) *Costs.* In addition, in the case of any successful action under paragraph (f) of this section, the costs of the action and any reasonable attorneys' fees incurred in connection with the action.

(2) *Nonliability.* A transferor or transferee servicer shall not be liable for any failure to comply with the requirements of this section, if within 60 days after discovering an error (whether pursuant to a final written examination report or the servicer's own procedures) and before commencement of an action under this section and the receipt of written notice of the error from the borrower, the servicer notifies the person concerned of the error and makes whatever adjustments are necessary in the appropriate account to ensure that the person will not be required to pay an amount in excess of any amount that the person otherwise would have paid.

(g) *Timely payments by servicer.* If the terms of any mortgage servicing loan require the borrower to make payments to the servicer of the loan for deposit into an escrow account for the purpose of assuring payment of taxes, insurance premiums, and other charges with respect to the mortgaged property, the servicer shall make payments from the escrow account in a timely manner for the taxes, insurance premiums, and other charges as the payments become due, as governed by the requirements in § 3500.17(k).

(h) *Preemption of State laws.* A lender who makes a mortgage servicing loan or a servicer shall be considered to have complied with the provisions of any State law or regulation requiring notice to a borrower at the time of application for a loan or transfer of servicing of a loan if the lender or servicer complies with the requirements of this section. Any State law requiring notice to the borrower at the time of application or at the time of transfer of servicing of the loan is preempted, and there shall be no additional borrower disclosure requirements. Provisions of State law, such as those requiring additional notices to insurance companies or taxing authorities, are not preempted by section 6 of RESPA or this

§ 3500.22

section, and this additional information may be added to a notice prepared under this section, if the procedure is allowable under State law.

(Approved by the Office of Management and Budget under control number 2502-0458)

[61 FR 13233, Mar. 26, 1996, as amended at 73 FR 68242, Nov. 17, 2008]

§ 3500.22 Severability.

If any particular provision of this part or the application of any particular provision to any person or circumstance is held invalid, the remainder of this part and the application of such provisions to other persons or circumstances shall not be affected by such holding.

[73 FR 68242, Nov. 17, 2008]

§ 3500.23 ESIGN applicability.

The Electronic Signatures in Global and National Commerce Act (“ESIGN”), 15 U.S.C. 7001-7031, shall apply to this part.

[73 FR 68243, Nov. 17, 2008]

APPENDIX A TO PART 3500—INSTRUCTIONS FOR COMPLETING HUD-1 AND HUD-1A SETTLEMENT STATEMENTS; SAMPLE HUD-1 AND HUD-1A STATEMENTS

The following are instructions for completing the HUD-1 settlement statement, required under section 4 of RESPA and 24 CFR part 3500 (Regulation X) of the Department of Housing and Urban Development regulations. This form is to be used as a statement of actual charges and adjustments paid by the borrower and the seller, to be given to the parties in connection with the settlement. The instructions for completion of the HUD-1 are primarily for the benefit of the settlement agents who prepare the statements and need not be transmitted to the parties as an integral part of the HUD-1. There is no objection to the use of the HUD-1 in transactions in which its use is not legally required. Refer to the definitions section of HUD’s regulations (24 CFR 3500.2) for specific definitions of many of the terms that are used in these instructions.

General Instructions

Information and amounts may be filled in by typewriter, hand printing, computer printing, or any other method producing clear and legible results. Refer to HUD’s regulations (Regulation X) regarding rules applicable to reproduction of the HUD-1 for the

24 CFR Ch. XX (4-1-11 Edition)

purpose of including customary recitals and information used locally in settlements; for example, a breakdown of payoff figures, a breakdown of the Borrower’s total monthly mortgage payments, check disbursements, a statement indicating receipt of funds, applicable special stipulations between Borrower and Seller, and the date funds are transferred.

The settlement agent shall complete the HUD-1 to itemize all charges imposed upon the Borrower and the Seller by the loan originator and all sales commissions, whether to be paid at settlement or outside of settlement, and any other charges which either the Borrower or the Seller will pay at settlement. Charges for loan origination and title services should not be itemized except as provided in these instructions. For each separately identified settlement service in connection with the transaction, the name of the person ultimately receiving the payment must be shown together with the total amount paid to such person. Items paid to and retained by a loan originator are disclosed as required in the instructions for lines in the 800-series of the HUD-1 (and for per diem interest, in the 900-series of the HUD-1).

As a general rule, charges that are paid for by the seller must be shown in the seller’s column on page 2 of the HUD-1 (unless paid outside closing), and charges that are paid for by the borrower must be shown in the borrower’s column (unless paid outside closing). However, in order to promote comparability between the charges on the GFE and the charges on the HUD-1, if a seller pays for a charge that was included on the GFE, the charge should be listed in the borrower’s column on page 2 of the HUD-1. That charge should also be offset by listing a credit in that amount to the borrower on lines 204-209 on page 1 of the HUD-1, and by a charge to the seller in lines 506-509 on page 1 of the HUD-1. If a loan originator (other than for no-cost loans), real estate agent, other settlement service provider, or other person pays for a charge that was included on the GFE, the charge should be listed in the borrower’s column on page 2 of the HUD-1, with an offsetting credit reported on page 1 of the HUD-1, identifying the party paying the charge.

Charges paid outside of settlement by the borrower, seller, loan originator, real estate agent, or any other person, must be included on the HUD-1 but marked “P.O.C.” for “Paid Outside of Closing” (settlement) and must not be included in computing totals. However, indirect payments from a lender to a mortgage broker may not be disclosed as P.O.C., and must be included as a credit on Line 802. P.O.C. items must not be placed in the Borrower or Seller columns, but rather on the appropriate line outside the columns. The settlement agent must indicate whether

P.O.C. items are paid for by the Borrower, Seller, or some other party by marking the items paid for by whoever made the payment as "P.O.C." with the party making the payment identified in parentheses, such as "P.O.C. (borrower)" or "P.O.C. (seller)".

In the case of "no cost" loans where "no cost" encompasses third party fees as well as the upfront payment to the loan originator, the third party services covered by the "no cost" provisions must be itemized and listed in the borrower's column on the HUD-1/1A with the charge for the third party service. These itemized charges must be offset with a negative adjusted origination charge on Line 803 and recorded in the columns.

Blank lines are provided in section L for any additional settlement charges. Blank lines are also provided for additional insertions in sections J and K. The names of the recipients of the settlement charges in section L and the names of the recipients of adjustments described in section J or K should be included on the blank lines.

Lines and columns in section J which relate to the Borrower's transaction may be left blank on the copy of the HUD-1 which will be furnished to the Seller. Lines and columns in section K which relate to the Seller's transaction may be left blank on the copy of the HUD-1 which will be furnished to the Borrower.

Line Item Instructions

Instructions for completing the individual items on the HUD-1 follow.

Section A. This section requires no entry of information.

Section B. Check appropriate loan type and complete the remaining items as applicable.

Section C. This section provides a notice regarding settlement costs and requires no additional entry of information.

Sections D and E. Fill in the names and current mailing addresses and zip codes of the Borrower and the Seller. Where there is more than one Borrower or Seller, the name and address of each one is required. Use a supplementary page if needed to list multiple Borrowers or Sellers.

Section F. Fill in the name, current mailing address and zip code of the Lender.

Section G. The street address of the property being sold should be listed. If there is no street address, a brief legal description or other location of the property should be inserted. In all cases give the zip code of the property.

Section H. Fill in name, address, zip code and telephone number of settlement agent, and address and zip code of "place of settlement."

Section I. Fill in date of settlement.

Section J. Summary of Borrower's Transaction. Line 101 is for the contract sales price of the property being sold, excluding the price of any items of tangible personal prop-

erty if Borrower and Seller have agreed to a separate price for such items.

Line 102 is for the sales price of any items of tangible personal property excluded from Line 101. Personal property could include such items as carpets, drapes, stoves, refrigerators, etc. What constitutes personal property varies from state to state. Manufactured homes are not considered personal property for this purpose.

Line 103 is used to record the total charges to Borrower detailed in Section L and totaled on Line 1400.

Lines 104 and 105 are for additional amounts owed by the Borrower, such as charges that were not listed on the GFE or items paid by the Seller prior to settlement but reimbursed by the Borrower at settlement. For example, the balance in the Seller's reserve account held in connection with an existing loan, if assigned to the Borrower in a loan assumption case, will be entered here. These lines will also be used when a tenant in the property being sold has not yet paid the rent, which the Borrower will collect, for a period of time prior to the settlement. The lines will also be used to indicate the treatment for any tenant security deposit. The Seller will be credited on Lines 404-405.

Lines 106 through 112 are for items which the Seller had paid in advance, and for which the Borrower must therefore reimburse the Seller. Examples of items for which adjustments will be made may include taxes and assessments paid in advance for an entire year or other period, when settlement occurs prior to the expiration of the year or other period for which they were paid. Additional examples include flood and hazard insurance premiums, if the Borrower is being substituted as an insured under the same policy; mortgage insurance in loan assumption cases; planned unit development or condominium association assessments paid in advance; fuel or other supplies on hand, purchased by the Seller, which the Borrower will use when Borrower takes possession of the property; and ground rent paid in advance.

Line 120 is for the total of Lines 101 through 112.

Line 201 is for any amount paid against the sales price prior to settlement.

Line 202 is for the amount of the new loan made by the Lender when a loan to finance construction of a new structure constructed for sale is used as or converted to a loan to finance purchase. Line 202 should also be used for the amount of the first user loan, when a loan to purchase a manufactured home for resale is converted to a loan to finance purchase by the first user. For other loans covered by 24 CFR part 3500 (Regulation X) which finance construction of a new structure or purchase of a manufactured home, list the sales price of the land on Line

104, the construction cost or purchase price of manufactured home on Line 105 (Line 101 would be left blank in this instance) and amount of the loan on Line 202. The remainder of the form should be completed taking into account adjustments and charges related to the temporary financing and permanent financing and which are known at the date of settlement.

Line 203 is used for cases in which the Borrower is assuming or taking title subject to an existing loan or lien on the property.

Lines 204-209 are used for other items paid by or on behalf of the Borrower. Lines 204-209 should be used to indicate any financing arrangements or other new loan not listed in Line 202. For example, if the Borrower is using a second mortgage or note to finance part of the purchase price, whether from the same lender, another lender or the Seller, insert the principal amount of the loan with a brief explanation on Lines 204-209. Lines 204-209 should also be used where the Borrower receives a credit from the Seller for closing costs, including seller-paid GFE charges. They may also be used in cases in which a Seller (typically a builder) is making an "allowance" to the Borrower for items that the Borrower is to purchase separately.

Lines 210 through 219 are for items which have not yet been paid, and which the Borrower is expected to pay, but which are attributable in part to a period of time prior to the settlement. In jurisdictions in which taxes are paid late in the tax year, most cases will show the proration of taxes in these lines. Other examples include utilities used but not paid for by the Seller, rent collected in advance by the Seller from a tenant for a period extending beyond the settlement date, and interest on loan assumptions.

Line 220 is for the total of Lines 201 through 219.

Lines 301 and 302 are summary lines for the Borrower. Enter total in Line 120 on Line 301. Enter total in Line 220 on Line 302.

Line 303 must indicate either the cash required from the Borrower at settlement (the usual case in a purchase transaction), or cash payable to the Borrower at settlement (if, for example, the Borrower's earnest money exceeds the Borrower's cash obligations in the transaction or there is a cash-out refinance). Subtract Line 302 from Line 301 and enter the amount of cash due to or from the Borrower at settlement on Line 303. The appropriate box should be checked. If the Borrower's earnest money is applied toward the charge for a settlement service, the amount so applied should not be included on Line 303 but instead should be shown on the appropriate line for the settlement service, marked "P.O.C. (Borrower)", and must not be included in computing totals.

Section K. Summary of Seller's Transaction. Instructions for the use of Lines 101 and 102 and 104-112 above, apply also to Lines 401-412.

Line 420 is for the total of Lines 401 through 412.

Line 501 is used if the Seller's real estate broker or other party who is not the settlement agent has received and holds a deposit against the sales price (earnest money) which exceeds the fee or commission owed to that party. If that party will render the excess deposit directly to the Seller, rather than through the settlement agent, the amount of excess deposit should be entered on Line 501 and the amount of the total deposit (including commissions) should be entered on Line 201.

Line 502 is used to record the total charges to the Seller detailed in section L and totaled on Line 1400.

Line 503 is used if the Borrower is assuming or taking title subject to existing liens which are to be deducted from sales price.

Lines 504 and 505 are used for the amounts (including any accrued interest) of any first and/or second loans which will be paid as part of the settlement.

Line 506 is used for deposits paid by the Borrower to the Seller or other party who is not the settlement agent. Enter the amount of the deposit in Line 201 on Line 506 unless Line 501 is used or the party who is not the settlement agent transfers all or part of the deposit to the settlement agent, in which case the settlement agent will note in parentheses on Line 507 the amount of the deposit that is being disbursed as proceeds and enter in the column for Line 506 the amount retained by the above-described party for settlement services. If the settlement agent holds the deposit, insert a note in Line 507 which indicates that the deposit is being disbursed as proceeds.

Lines 506 through 509 may be used to list additional liens which must be paid off through the settlement to clear title to the property. Other Seller obligations should be shown on Lines 506-509, including charges that were disclosed on the GFE but that are actually being paid for by the Seller. These Lines may also be used to indicate funds to be held by the settlement agent for the payment of either repairs, or water, fuel, or other utility bills that cannot be prorated between the parties at settlement because the amounts used by the Seller prior to settlement are not yet known. Subsequent disclosure of the actual amount of these post-settlement items to be paid from settlement funds is optional. Any amounts entered on Lines 204-209 including Seller financing arrangements should also be entered on Lines 506-509.

Instructions for the use of Lines 510 through 519 are the same as those for Lines 210 to 219 above.

Line 520 is for the total of Lines 501 through 519.

Lines 601 and 602 are summary lines for the Seller. Enter the total in Line 420 on Line 610. Enter the total in Line 520 on Line 602.

Line 603 must indicate either the cash required to be paid to the Seller at settlement (the usual case in a purchase transaction), or the cash payable by the Seller at settlement. Subtract Line 602 from Line 601 and enter the amount of cash due to or from the Seller at settlement on Line 603. The appropriate box should be checked.

Section L. Settlement Charges.

Line 700 is used to enter the sales commission charged by the sales agent or real estate broker.

Lines 701-702 are to be used to state the split of the commission where the settlement agent disburses portions of the commission to two or more sales agents or real estate brokers.

Line 703 is used to enter the amount of sales commission disbursed at settlement. If the sales agent or real estate broker is retaining a part of the deposit against the sales price (earnest money) to apply towards the sales agent's or real estate broker's commission, include in Line 703 only that part of the commission being disbursed at settlement and insert a note on Line 704 indicating the amount the sales agent or real estate broker is retaining as a "P.O.C." item.

Line 704 may be used for additional charges made by the sales agent or real estate broker, or for a sales commission charged to the Borrower, which will be disbursed by the settlement agent.

Line 801 is used to record "Our origination charge," which includes all charges received by the loan originator, except any charge for the specific interest rate chosen (points). This number must not be listed in either the buyer's or seller's column. The amount shown in Line 801 must include any amounts received for origination services, including administrative and processing services, performed by or on behalf of the loan originator.

Line 802 is used to record "Your credit or charge (points) for the specific interest rate chosen," which states the charge or credit adjustment as applied to "Our origination charge," if applicable. This number must not be listed in either column or shown on page one of the HUD-1.

For a mortgage broker originating a loan in its own name, the amount shown on Line 802 will be the difference between the initial loan amount and the total payment to the mortgage broker from the lender. The total payment to the mortgage broker will be the sum of the price paid for the loan by the lender and any other payments to the mortgage broker from the lender, including any payments based on the loan amount or loan terms, and any flat rate payments. For a mortgage broker originating a loan in another entity's name, the amount shown on

Line 802 will be the sum of all payments to the mortgage broker from the lender, including any payments based on the loan amount or loan terms, and any flat rate payments.

In either case, when the amount paid to the mortgage broker exceeds the initial loan amount, there is a credit to the borrower and it is entered as a negative amount. When the initial loan amount exceeds the amount paid to the mortgage broker, there is a charge to the borrower and it is entered as a positive amount. For a lender, the amount shown on Line 802 may include any credit or charge (points) to the Borrower.

Line 803 is used to record "Your adjusted origination charges," which states the net amount of the loan origination charges, the sum of the amounts shown in Lines 801 and 802. This amount must be listed in the columns as either a positive number (for example, where the origination charge shown in Line 801 exceeds any credit for the interest rate shown in Line 802 or where there is an origination charge in Line 801 and a charge for the interest rate (points) is shown on Line 802) or as a negative number (for example, where the credit for the interest rate shown in Line 802 exceeds the origination charges shown in Line 801).

In the case of "no cost" loans, where "no cost" refers only to the loan originator's fees, the amounts shown in Lines 801 and 802 should offset, so that the charge shown on Line 803 is zero. Where "no cost" includes third party settlement services, the credit shown in Line 802 will more than offset the amount shown in Line 801. The amount shown in Line 803 will be a negative number to offset the settlement charges paid indirectly through the loan originator.

Lines 804-808 may be used to record each of the "Required services that we select." Each settlement service provider must be identified by name and the amount paid recorded either inside the columns or as paid to the provider outside closing ("P.O.C."), as described in the General Instructions.

Line 804 is used to record the appraisal fee.

Line 805 is used to record the fee for all credit reports.

Line 806 is used to record the fee for any tax service.

Line 807 is used to record any flood certification fee.

Lines 808 and additional sequentially numbered lines, as needed, are used to record other third party services required by the loan originator. These Lines may also be used to record other required disclosures from the loan originator. Any such disclosures must be listed outside the columns.

Lines 901-904. This series is used to record the items which the Lender requires to be paid at the time of settlement, but which are not necessarily paid to the lender (e.g., FHA mortgage insurance premium), other than

reserves collected by the Lender and recorded in the 1000-series.

Line 901 is used if interest is collected at settlement for a part of a month or other period between settlement and the date from which interest will be collected with the first regular monthly payment. Enter that amount here and include the per diem charges. If such interest is not collected until the first regular monthly payment, no entry should be made on Line 901.

Line 902 is used for mortgage insurance premiums due and payable at settlement, including any monthly amounts due at settlement and any upfront mortgage insurance premium, but not including any reserves collected by the Lender and recorded in the 1000-series. If a lump sum mortgage insurance premium paid at settlement is included on Line 902, a note should indicate that the premium is for the life of the loan.

Line 903 is used for homeowner's insurance premiums that the Lender requires to be paid at the time of settlement, except reserves collected by the Lender and recorded in the 1000-series.

Lines 904 and additional sequentially numbered lines are used to list additional items required by the Lender (except for reserves collected by the Lender and recorded in the 1000-series), including premiums for flood or other insurance. These lines are also used to list amounts paid at settlement for insurance not required by the Lender.

Lines 1000-1007. This series is used for amounts collected by the Lender from the Borrower and held in an account for the future payment of the obligations listed as they fall due. Include the time period (number of months) and the monthly assessment. In many jurisdictions this is referred to as an "escrow", "impound", or "trust" account. In addition to the property taxes and insurance listed, some Lenders may require reserves for flood insurance, condominium owners' association assessments, etc. The amount in line 1001 must be listed in the columns, and the itemizations in lines 1002 through 1007 must be listed outside the columns.

After itemizing individual deposits in the 1000 series, the servicer shall make an adjustment based on aggregate accounting. This adjustment equals the difference between the deposit required under aggregate accounting and the sum of the itemized deposits. The computation steps for aggregate accounting are set out in 24 CFR §3500.17(d). The adjustment will always be a negative number or zero (-0-), except for amounts due to rounding. The settlement agent shall enter the aggregate adjustment amount outside the columns on a final line of the 1000 series of the HUD-1 or HUD-1A statement. Appendix E to this part sets out an example of aggregate analysis.

Lines 1100-1108. This series covers title charges and charges by attorneys and closing or settlement agents. The title charges include a variety of services performed by title companies or others, and include fees directly related to the transfer of title (title examination, title search, document preparation), fees for title insurance, and fees for conducting the closing. The legal charges include fees for attorneys representing the lender, seller, or borrower, and any attorney preparing title work. The series also includes any settlement, notary, and delivery fees related to the services covered in this series. Disbursements to third parties must be broken out in the appropriate lines or in blank lines in the series, and amounts paid to these third parties must be shown outside of the columns if included in Line 1101. Charges not included in Line 1101 must be listed in the columns.

Line 1101 is used to record the total for the category of "Title services and lender's title insurance." This amount must be listed in the columns.

Line 1102 is used to record the settlement or closing fee.

Line 1103 is used to record the charges for the owner's title insurance and related endorsements. This amount must be listed in the columns.

Line 1104 is used to record the lender's title insurance premium and related endorsements.

Line 1105 is used to record the amount of the lender's title policy limit. This amount is recorded outside of the columns.

Line 1106 is used to record the amount of the owner's title policy limit. This amount is recorded outside of the columns.

Line 1107 is used to record the amount of the total title insurance premium, including endorsements, that is retained by the title agent. This amount is recorded outside of the columns.

Line 1108 used to record the amount of the total title insurance premium, including endorsements, that is retained by the title underwriter. This amount is recorded outside of the columns.

Additional sequentially numbered lines in the 1100-series may be used to itemize title charges paid to other third parties, as identified by name and type of service provided.

Lines 1200-1206. This series covers government recording and transfer charges. Charges paid by the borrower must be listed in the columns as described for lines 1201 and 1203, with itemizations shown outside the columns. Any amounts that are charged to the seller and that were not included on the Good Faith Estimate must be listed in the columns.

Line 1201 is used to record the total "Government recording charges," and the amount must be listed in the columns.

Line 1202 is used to record, outside of the columns, the itemized recording charges.

Line 1203 is used to record the transfer taxes, and the amount must be listed in the columns.

Line 1204 is used to record, outside of the columns, the amounts for local transfer taxes and stamps.

Line 1205 is used to record, outside of the columns, the amounts for State transfer taxes and stamps.

Line 1206 and additional sequentially numbered lines may be used to record specific itemized third party charges for government recording and transfer services, but the amounts must be listed outside the columns.

Line 1301 and additional sequentially numbered lines must be used to record required services that the borrower can shop for, such as fees for survey, pest inspection, or other similar inspections. These lines may also be used to record additional itemized settlement charges that are not included in a specific category, such as fees for structural and environmental inspections; pre-sale inspections of heating, plumbing or electrical equipment; or insurance or warranty coverage. The amounts must be listed in either the borrower's or seller's column.

Line 1400 must state the total settlement charges as calculated by adding the amounts within each column.

Page 3

Comparison of Good Faith Estimate (GFE) and HUD-1/1A Charges

The comparison chart must be prepared using the exact information and amounts from the GFE and the actual settlement charges shown on the HUD-1/1A Settlement Statement. The comparison chart is comprised of three sections: "Charges That Cannot Increase", "Charges That Cannot Increase More Than 10%", and "Charges That Can Change".

"Charges That Cannot Increase". The amounts shown in Blocks 1 and 2, in Line A, and in Block 8 on the borrower's GFE must be entered in the appropriate line in the Good Faith Estimate column. The amounts shown on Lines 801, 802, 803 and 1203 of the HUD-1/1A must be entered in the corresponding line in the HUD-1/1A column. The HUD-1/1A column must include any amounts shown on page 2 of the HUD-1 in the column as paid for by the borrower, plus any amounts that are shown as P.O.C. by or on behalf of the borrower. If there is a credit in Block 2 of the GFE or Line 802 of the HUD-1/1A, the credit should be entered as a negative number.

"Charges That Cannot Increase More Than 10%". A description of each charge included in Blocks 3 and 7 on the borrower's GFE must be entered on separate lines in this section, with the amount shown on the bor-

rower's GFE for each charge entered in the corresponding line in the Good Faith Estimate column. For each charge included in Blocks 4, 5 and 6 on the borrower's GFE for which the loan originator selected the provider or for which the borrower selected a provider identified by the loan originator, a description must be entered on a separate line in this section, with the amount shown on the borrower's GFE for each charge entered in the corresponding line in the Good Faith Estimate column. The loan originator must identify any third party settlement services for which the borrower selected a provider other than one identified by the loan originator so that the settlement agent can include those charges in the appropriate category. Additional lines may be added if necessary. The amounts shown on the HUD-1/1A for each line must be entered in the HUD-1/1A column next to the corresponding charge from the GFE, along with the appropriate HUD-1/1A line number. The HUD-1/1A column must include any amounts shown on page 2 of the HUD-1 in the column as paid for by the borrower, plus any amounts that are shown as P.O.C. by or on behalf of the borrower.

The amounts shown in the Good Faith Estimate and HUD-1/1A columns for this section must be separately totaled and entered in the designated line. If the total for the HUD-1/1A column is greater than the total for the Good Faith Estimate column, then the amount of the increase must be entered both as a dollar amount and as a percentage increase in the appropriate line.

"Charges That Can Change". The amounts shown in Blocks 9, 10 and 11 on the borrower's GFE must be entered in the appropriate line in the Good Faith Estimate column. Any third party settlement services for which the borrower selected a provider other than one identified by the loan originator must also be included in this section. The amounts shown on the HUD-1/1A for each charge in this section must be entered in the corresponding line in the HUD-1/1A column, along with the appropriate HUD-1/1A line number. The HUD-1/1A column must include any amounts shown on page 2 of the HUD-1 in the column as paid for by the borrower, plus any amounts that are shown as P.O.C. by or on behalf of the borrower. Additional lines may be added if necessary.

Loan Terms

This section must be completed in accordance with the information and instructions provided by the lender. The lender must provide this information in a format that permits the settlement agent to simply enter the necessary information in the appropriate spaces, without the settlement agent having to refer to the loan documents themselves.

*Instructions for Completing HUD-1A**Line-Item Instructions*

NOTE: The HUD-1A is an optional form that may be used for refinancing and subordinate-lien federally related mortgage loans, as well as for any other one-party transaction that does not involve the transfer of title to residential real property. The HUD-1 form may also be used for such transactions, by utilizing the borrower's side of the HUD-1 and following the relevant parts of the instructions as set forth above. The use of either the HUD-1 or HUD-1A is not mandatory for open-end lines of credit (home-equity plans), as long as the provisions of Regulation Z are followed.

Page 1

The identification information at the top of the HUD-1A should be completed as follows:

The borrower's name and address is entered in the space provided. If the property securing the loan is different from the borrower's address, the address or other location information on the property should be entered in the space provided. The loan number is the lender's identification number for the loan. The settlement date is the date of settlement in accordance with 24 CFR 3500.2, not the end of any applicable rescission period. The name and address of the lender should be entered in the space provided.

Section L. Settlement Charges. This section of the HUD-1A is similar to Section L of the HUD-1, with minor changes or omissions, including deletion of lines 700 through 704, relating to real estate broker commissions. The instructions for Section L in the HUD-1, should be followed insofar as possible. Inapplicable charges should be ignored, as should any instructions regarding seller items.

Line 1400 in the HUD-1A is for the total settlement charges charged to the borrower. Enter this total on line 1601. This total should include Section L amounts from additional pages, if any are attached to this HUD-1A.

Section M. Disbursement to Others. This section is used to list payees, other than the borrower, of all or portions of the loan proceeds (including the lender, if the loan is paying off a prior loan made by the same lender), when the payee will be paid directly out of the settlement proceeds. It is not used to list payees of settlement charges, nor to list funds disbursed directly to the borrower, even if the lender knows the borrower's intended use of the funds.

For example, in a refinancing transaction, the loan proceeds are used to pay off an existing loan. The name of the lender for the loan being paid off and the pay-off balance would be entered in Section M. In a home improvement transaction when the proceeds are to be paid to the home improvement contractor, the name of the contractor and the amount paid to the contractor would be entered in Section M. In a consolidation loan, or when part of the loan proceeds is used to pay off other creditors, the name of each creditor and the amount paid to that creditor would be entered in Section M. If the proceeds are to be given directly to the borrower and the borrower will use the proceeds to pay off existing obligations, this would not be reflected in Section M.

Section N. Net Settlement. Line 1600 normally sets forth the principal amount of the loan as it appears on the related note for this loan. In the event this form is used for an

Background

The HUD-1A settlement statement is to be used as a statement of actual charges and adjustments to be given to the borrower at settlement, as defined in this part. The instructions for completion of the HUD-1A are for the benefit of the settlement agent who prepares the statement; the instructions are not a part of the statement and need not be transmitted to the borrower. There is no objection to using the HUD-1A in transactions in which it is not required, and its use in open-end lines of credit transactions (home-equity plans) is encouraged. It may not be used as a substitute for a HUD-1 in any transaction that has a seller.

Refer to the "definitions" section (§3500.2) of 24 CFR part 3500 (Regulation X) for specific definitions of terms used in these instructions.

General Instructions

Information and amounts may be filled in by typewriter, hand printing, computer printing, or any other method producing clear and legible results. Refer to 24 CFR 3500.9 regarding rules for reproduction of the HUD-1A. Additional pages may be attached to the HUD-1A for the inclusion of customary recitals and information used locally for settlements or if there are insufficient lines on the HUD-1A. The settlement agent shall complete the HUD-1A in accordance with the instructions for the HUD-1 to the extent possible, including the instructions for disclosing items paid outside closing and for no cost loans.

Blank lines are provided in Section L for any additional settlement charges. Blank lines are also provided in Section M for recipients of all or portions of the loan proceeds. The names of the recipients of the settlement charges in Section L and the names of the recipients of the loan proceeds in Section M should be set forth on the blank lines.

Office of Asst. Sec. for Housing, HUD

Pt. 3500, App. A

open-ended home equity line whose approved amount is greater than the initial amount advanced at settlement, the amount shown on Line 1600 will be the loan amount advanced at settlement. Line 1601 is used for all settlement charges that both are included in the totals for lines 1400 and 1602, and are not financed as part of the principal amount of the loan. This is the amount normally received by the lender from the borrower at settlement, which would occur when some or all of the settlement charges were paid in cash by the borrower at settlement, instead of being financed as part of the principal amount of the loan. Failure to include any such amount in line 1601 will result in an error in the amount calculated on line 1604. Items paid outside of closing (P.O.C.) should not be included in Line 1601.

Line 1602 is the total amount from line 1400.

Line 1603 is the total amount from line 1520.

Line 1604 is the amount disbursed to the borrower. This is determined by adding together the amounts for lines 1600 and 1601, and then subtracting any amounts listed on lines 1602 and 1603.

Page 2

This section of the HUD-1A is similar to page 3 of the HUD-1. The instructions for page 3 of the HUD-1, should be followed insofar as possible. The HUD-1/1A Column should include any amounts shown on page 1 of the HUD-1A in the column as paid for by the borrower, plus any amounts that are shown as P.O.C. by the borrower. Inapplicable charges should be ignored.



A. Settlement Statement (HUD-1)

OMB Approval No. 2502-0265

B. Type of Loan			6. File Number:	7. Loan Number:	8. Mortgage Insurance Case Number:
1. <input type="checkbox"/> FHA	2. <input type="checkbox"/> RHS	3. <input type="checkbox"/> Conv. Unins.			
4. <input type="checkbox"/> VA	5. <input type="checkbox"/> Conv. Ins.				
C. Note: This form is furnished to give you a statement of actual settlement costs. Amounts paid to and by the settlement agent are shown. Items marked "p.o.c." were paid outside the closing; they are shown here for informational purposes and are not included in the totals.					
D. Name & Address of Borrower:		E. Name & Address of Seller:		F. Name & Address of Lender:	
G. Property Location:		H. Settlement Agent: Place of Settlement:		I. Settlement Date:	

J. Summary of Borrower's Transaction		K. Summary of Seller's Transaction	
100. Gross Amount Due from Borrower		400. Gross Amount Due to Seller	
101. Contract sales price		401. Contract sales price	
102. Personal property		402. Personal property	
103. Settlement charges to borrower (line 1400)		403.	
104.		404.	
105.		405.	
Adjustment for items paid by seller in advance		Adjustments for items paid by seller in advance	
106. City/town taxes to		406. City/town taxes to	
107. County taxes to		407. County taxes to	
108. Assessments to		408. Assessments to	
109.		409.	
110.		410.	
111.		411.	
112.		412.	
120. Gross Amount Due from Borrower		420. Gross Amount Due to Seller	
200. Amounts Paid by or in Behalf of Borrower		500. Reductions In Amount Due to Seller	
201. Deposit or earnest money		501. Excess deposit (see instructions)	
202. Principal amount of new loan(s)		502. Settlement charges to seller (line 1400)	
203. Existing loan(s) taken subject to		503. Existing loan(s) taken subject to	
204.		504. Payoff of first mortgage loan	
205.		505. Payoff of second mortgage loan	
206.		506.	
207.		507.	
208.		508.	
209.		509.	
Adjustments for items unpaid by seller		Adjustments for items unpaid by seller	
210. City/town taxes to		510. City/town taxes to	
211. County taxes to		511. County taxes to	
212. Assessments to		512. Assessments to	
213.		513.	
214.		514.	
215.		515.	
216.		516.	
217.		517.	
218.		518.	
219.		519.	
220. Total Paid by/for Borrower		520. Total Reduction Amount Due Seller	
300. Cash at Settlement from/to Borrower		600. Cash at Settlement to/from Seller	
301. Gross amount due from borrower (line 120)		601. Gross amount due to seller (line 420)	
302. Less amounts paid by/for borrower (line 220)	()	602. Less reductions in amount due seller (line 520)	()
303. Cash <input type="checkbox"/> From <input type="checkbox"/> To Borrower		603. Cash <input type="checkbox"/> To <input type="checkbox"/> From Seller	

The Public Reporting Burden for this collection of information is estimated at 35 minutes per response for collecting, reviewing, and reporting the data. This agency may not collect this information, and you are not required to complete this form, unless it displays a currently valid OMB control number. No confidentiality is assured; this disclosure is mandatory. This is designed to provide the parties to a RESPA covered transaction with information during the settlement process.

L. Settlement Charges							
700. Total Real Estate Broker Fees						Paid From Borrower's Funds at Settlement	Paid From Seller's Funds at Settlement
Division of commission (line 700) as follows:							
701. \$		to					
702. \$		to					
703. Commission paid at settlement							
704.							
800. Items Payable in Connection with Loan							
801. Our origination charge	\$		(from GFE #1)				
802. Your credit or charge (points) for the specific interest rate chosen	\$		(from GFE #2)				
803. Your adjusted origination charges			(from GFE #4)				
804. Appraisal fee to			(from GFE #3)				
805. Credit report to			(from GFE #3)				
806. Tax service to			(from GFE #3)				
807. Flood certification			(from GFE #5)				
808.							
900. Items Required by Lender to Be Paid in Advance							
901. Daily interest charges from	to	@ \$	/day	(from GFE #10)			
902. Mortgage insurance premium	for	months to		(from GFE #3)			
903. Homeowner's insurance	for	years to		(from GFE #11)			
904.							
1000. Reserves Deposited with Lender							
1001. Initial deposit for your escrow account			(from GFE #9)				
1002. Homeowner's insurance	months @ \$	per month	\$				
1003. Mortgage insurance	months @ \$	per month	\$				
1004. Property taxes	months @ \$	per month	\$				
1005.	months @ \$	per month	\$				
1006.	months @ \$	per month	\$				
1007. Aggregate Adjustment			\$				
1100. Title Charges							
1101. Title services and lender's title insurance			(from GFE #4)				
1102. Settlement or closing fee	\$						
1103. Owner's title insurance			(from GFE #5)				
1104. Lender's title insurance	\$						
1105. Lender's title policy limit	\$						
1106. Owner's title policy limit	\$						
1107. Agent's portion of the total title insurance premium	\$						
1108. Underwriter's portion of the total title insurance premium	\$						
1200. Government Recording and Transfer Charges							
1201. Government recording charges			(from GFE #7)				
1202. Deed \$	Mortgage \$	Releases \$					
1203. Transfer taxes (from GFE #8)							
1204. City/County tax/stamps	Deed \$	Mortgage \$					
1205. State tax/stamps	Deed \$	Mortgage \$					
1206.							
1300. Additional Settlement Charges							
1301. Required services that you can shop for			(from GFE #6)				
1302.	\$						
1303.	\$						
1304.							
1305.							
1400. Total Settlement Charges (enter on lines 103, Section J and 502, Section K)							

Comparison of Good Faith Estimate (GFE) and HUD-1 Charges		Good Faith Estimate	HUD-1
Charges That Cannot Increase	HUD-1 Line Number		
Our origination charge	# 801		
Your credit or charge (points) for the specific interest rate chosen	# 802		
Your adjusted origination charges	# 803		
Transfer taxes	#1203		

Charges That in Total Cannot Increase More Than 10%		Good Faith Estimate	HUD-1
Government recording charges	# 1201		
	#		
	#		
	#		
	#		
	#		
	#		
	#		
	#		
Total			
Increase between GFE and HUD-1 Charges		\$	or %

Charges That Can Change		Good Faith Estimate	HUD-1
Initial deposit for your escrow account	#1001		
Daily interest charges	# 901 \$ /day		
Homeowner's insurance	# 903		
	#		
	#		
	#		

Loan Terms

Your initial loan amount is	\$ []
Your loan term is	[] years
Your initial interest rate is	[] %
Your initial monthly amount owed for principal, interest, and any mortgage insurance is	\$ [] includes <input type="checkbox"/> Principal <input type="checkbox"/> Interest <input type="checkbox"/> Mortgage Insurance
Can your interest rate rise?	<input type="checkbox"/> No. <input type="checkbox"/> Yes, it can rise to a maximum of []%. The first change will be on [] and can change again every [] after []. Every change date, your interest rate can increase or decrease by []%. Over the life of the loan, your interest rate is guaranteed to never be lower than []% or higher than []%.
Even if you make payments on time, can your loan balance rise?	<input type="checkbox"/> No. <input type="checkbox"/> Yes, it can rise to a maximum of \$ [].
Even if you make payments on time, can your monthly amount owed for principal, interest, and mortgage insurance rise?	<input type="checkbox"/> No. <input type="checkbox"/> Yes, the first increase can be on [] and the monthly amount owed can rise to \$ []. The maximum it can ever rise to is \$ [].
Does your loan have a prepayment penalty?	<input type="checkbox"/> No. <input type="checkbox"/> Yes, your maximum prepayment penalty is \$ [].
Does your loan have a balloon payment?	<input type="checkbox"/> No. <input type="checkbox"/> Yes, you have a balloon payment of \$ [] due in [] years on [].
Total monthly amount owed including escrow account payments	<input type="checkbox"/> You do not have a monthly escrow payment for items, such as property taxes and homeowner's insurance. You must pay these items directly yourself. <input type="checkbox"/> You have an additional monthly escrow payment of \$ [] that results in a total initial monthly amount owed of \$ []. This includes principal, interest, any mortgage insurance and any items checked below: <input type="checkbox"/> Property taxes <input type="checkbox"/> Homeowner's insurance <input type="checkbox"/> Flood insurance <input type="checkbox"/> [] <input type="checkbox"/> [] <input type="checkbox"/> []

Note: If you have any questions about the Settlement Charges and Loan Terms listed on this form, please contact your lender.



Settlement Statement (HUD-1A)
Optional Form for Transactions without Sellers

OMB Approval No. 2502-0265

Name and Address of Borrower:	Name and Address of Lender:
Property Location: (if different from above)	Settlement Agent:
	Place of Settlement:
Loan Number:	Settlement Date:

L. Settlement Charges				M. Disbursements to Others	
800. Items Payable in Connection with Loan				1501.	
801. Our origination charge		(from GFE #1) \$			
802. Your credit or charge points for the specific interest rate chosen		(from GFE #2) \$			1502.
803. Your adjusted origination charges		(from GFE #3)			
804. Appraisal fee to		(from GFE #4)			1503.
805. Credit report to		(from GFE #5)			
806. Tax service to		(from GFE #6)			1504.
807. Flood certification		(from GFE #7)			
808.					1505.
900. Items Required by Lender to Be Paid in Advance					
901. Daily interest charges from to @ \$ /day		(from GFE #10)			1506.
902. Mortgage insurance premium for months to		(from GFE #9)			
903. Homeowner's insurance for years to		(from GFE #11)			1507.
904.					
1000. Reserves Deposited with Lender				1508.	
1001. Initial deposit for your escrow account		(from GFE #8)			
1002. Homeowner's insurance months @ \$ per month \$					1509.
1003. Mortgage insurance months @ \$ per month \$					
1004. Property taxes months @ \$ per month \$					1510.
1005. months @ \$ per month \$					
1006. months @ \$ per month \$					1511.
1007. Aggregate Adjustment -\$					
1100. Title Charges				1512.	
1101. Title insurance and lender's title insurance		(from GFE #6)			
1102. Settlement or closing fee		\$			1513.
1103. Owner's title insurance		(from GFE #5)			
1104. Lender's title insurance		\$			1514.
1105. Lender's title policy limit \$					
1106. Owner's title policy limit \$					1515.
1107. Agent's portion of the total title insurance premium		\$			
1108. Underwriter's portion of the total title insurance premium		\$			1520. Total Disbursed (enter on line 1403)
1200. Government Recording and Transfer Charges					
1201. Government recording charges		(from GFE #7)			
1202. Deed \$ Mortgage \$ Release \$					
1203. Transfer taxes		(from GFE #8)			
1204. City/County tax/stamps Deed \$ Mortgage \$					
1205. State tax/stamps Deed \$ Mortgage \$					
1206.					
1300. Additional Settlement Charges				1600. Net Settlement	
1301. Required services that you can shop for		(from GFE #6)		1600. Loan Amount	\$
1302.		\$		1601. Plus Cash/Check from Borrower	\$
1303.		\$		1602. Minus Total Settlement Charges (line 1403)	\$
1304.				1603. Minus Total Disbursements to Others (line 1520)	\$
1305.				1604. Equals Total Disbursements to Borrower (after expiration of any applicable rescission period required by law)	\$
1400. Total Settlement Charges (enter on line 1602, Section N)					

The Public Reporting Burden for this collection of information is estimated to average 35 minutes per response for collecting, reviewing, and reporting the data. This agency may not collect this information, and you are not required to complete this form, unless it displays a currently valid OMB control number. No confidentiality is assured; this disclosure is mandatory. This is designed to provide the parties to a RESPA covered transaction with information during the settlement process.

APPENDIX B TO PART 3500—ILLUSTRATIONS OF REQUIREMENTS OF RESPA

The following illustrations provide additional guidance on the meaning and coverage of the provisions of RESPA. Other provisions of Federal or State law may also be applicable to the practices and payments discussed in the following illustrations.

1. *Facts:* A, a provider of settlement services, provides settlement services at abnormally low rates or at no charge at all to B, a builder, in connection with a subdivision being developed by B. B agrees to refer purchasers of the completed homes in the subdivision to A for the purchase of settlement services in connection with the sale of individual lots by B.

Comments: The rendering of services by A to B at little or no charge constitutes a thing of value given by A to B in return for the referral of settlement services business and both A and B are in violation of section 8 of RESPA.

2. *Facts:* B, a lender, encourages persons who receive federally-related mortgage loans from it to employ A, an attorney, to perform title searches and related settlement services in connection with their transaction. B and A have an understanding that in return for the referral of this business A provides legal services to B or B's officers or employees at abnormally low rates or for no charge.

Comments: Both A and B are in violation of section 8 of RESPA. Similarly, if an attorney gives a portion of his or her fees to another attorney, a lender, a real estate broker or any other provider of settlement services, who had referred prospective clients to the attorney, section 8 would be violated by both persons.

3. *Facts:* A, a real estate broker, obtains all necessary licenses under state law to act as a title insurance agent. A refers individuals who are purchasing homes in transactions in which A participates as a broker to B, an unaffiliated title company, for the purchase of title insurance services. A performs minimal, if any, title services in connection with the issuance of the title insurance policy (such as placing an application with the title company). B pays A a commission (or A retains a portion of the title insurance premium) for the transactions or alternatively B receives a portion of the premium paid directly from the purchaser.

Comments: The payment of a commission or portion of the title insurance premium by B to A, or receipt of a portion of the payment for title insurance under circumstances where no substantial services are being performed by A is a violation of section 8 of RESPA. It makes no difference whether the payment comes from B or the purchaser. The amount of the payment must bear a reasonable relationship to the services rendered.

Here A really is being compensated for a referral of business to B.

4. *Facts:* A is an attorney who, as a part of his legal representation of clients in residential real estate transactions, orders and reviews title insurance policies for his clients. A enters into a contract with B, a title company, to be an agent of B under a program set up by B. Under the agreement, A agrees to prepare and forward title insurance applications to B, to re-examine the preliminary title commitment for accuracy and if he chooses to attempt to clear exceptions to the title policy before closing. A agrees to assume liability for waiving certain exceptions to title, but never exercises this authority. B performs the necessary title search and examination work, determines insurability of title, prepares documents containing substantive information in title commitments, handles closings for A's clients and issues title policies. A receives a fee from his client for legal services and an additional fee for his title agent "services" from the client's title insurance premium to B.

Comments: A and B are violating section 8 of RESPA. Here, A's clients are being double billed because the work A performs as a "title agent" is that which he already performs for his client in his capacity as an attorney. For A to receive a separate payment as a title agent, A must perform necessary core title work and may not contract out the work. To receive additional compensation as a title agent for this transaction, A must provide his client with core title agent services for which he assumes liability, and which includes, at a minimum, the evaluation of the title search to determine insurability of the title, and the issuance of a title commitment where customary, the clearance of underwriting objections, and the actual issuance of the policy or policies on behalf of the title company. A may not be compensated for the mere re-examination of work performed by B. Here, A is not performing these services and may not be compensated as a title agent under section 8(c)(1)(B). Referral fees or splits of fees may not be disguised as title agent commissions when the core title agent work is not performed. Further, because B created the program and gave A the opportunity to collect fees (a thing of value) in exchange for the referral of settlement service business, it has violated section 8 of RESPA.

5. *Facts:* A, a "mortgage originator," receives loan applications, funds the loans with its own money or with a wholesale line of credit for which A is liable, and closes the loans in A's own name. Subsequently, B, a mortgage lender, purchases the loans and compensates A for the value of the loans, as well as for any mortgage servicing rights.

Comments: Compensation for the sale of a mortgage loan and servicing rights constitutes a secondary market transaction,

rather than a referral fee, and is beyond the scope of section 8 of RESPA. For purposes of section 8, in determining whether a *bona fide* transfer of the loan obligation has taken place, HUD examines the real source of funding, and the real interest of the named settlement lender.

6. *Facts:* A, a credit reporting company, places a facsimile transmission machine (FAX) in the office of B, a mortgage lender, so that B can easily transmit requests for credit reports and A can respond. A supplies the FAX machine at no cost or at a reduced rental rate based on the number of credit reports ordered.

Comments: Either situation violates section 8 of RESPA. The FAX machine is a thing of value that A provides in exchange for the referral of business from B. Copying machines, computer terminals, printers, or other like items which have general use to the recipient and which are given in exchange for referrals of business also violate RESPA.

7. *Facts:* A, a real estate broker, refers title business to B, a company that is a licensed title agent for C, a title insurance company. A owns more than 1% of B. B performs the title search and examination, makes determinations of insurability, issues the commitment, clears underwriting objections, and issues a policy of title insurance on behalf of C, for which C pays B a commission. B pays annual dividends to its owners, including A, based on the relative amount of business each of its owners refers to B.

Comments: The facts involve an affiliated business arrangement. The payments of a commission by C to B is not a violation of section 8 of RESPA if the amount of the commission constitutes reasonable compensation for the services performed by B for C. The payment of a dividend or the giving of any other thing of value by B to A that is based on the amount of business referred to B by A does not meet the affiliated business agreement exemption provisions and such actions violate section 8. Similarly, if the amount of stock held by A in B (or, if B were a partnership, the distribution of partnership profits by B to A) varies based on the amount of business referred or expected to be referred, or if B retained any funds for subsequent distribution to A where such funds were generally in proportion to the amount of business A referred to B relative to the amount referred by other owners such arrangements would violate section 8. The exemption for controlled business arrangements would not be available because the payments here would not be considered returns on ownership interests. Further, the required disclosure of the affiliated business arrangement and estimated charges have not been provided.

8. *Facts:* Same as illustration 7, but B pays annual dividends in proportion to the amount of stock held by its owners, includ-

ing A, and the distribution of annual dividends is not based on the amount of business referred or expected to be referred.

Comments: If A and B meet the requirements of the affiliated business arrangement exemption there is not a violation of RESPA. Since the payment is a return on ownership interests, A and B will be exempt from section 8 if (1) A also did not require anyone to use the services of B, and (2) A disclosed its ownership interest in B on a separate disclosure form and provided an estimate of B's charges to each person referred by A to B (see appendix D of this part), and (3) B makes no payment (nor is there any other thing of value exchanged) to A other than dividends.

9. *Facts:* A, a franchisor for franchised real estate brokers, owns B, a provider of settlement services. C, a franchisee of A, refers business to B.

Comments: This is an affiliated business arrangement. A, B and C will all be exempt from section 8 if C discloses its franchise relationship with the owner of B on a separate disclosure form and provides an estimate of B's charges to each person referred to B (see appendix D of this part) and C does not require anyone to use B's services and A gives no thing a value to C under the franchise agreement (such as an adjusted level of franchise payment based on the referrals), and B makes no payments to A other than dividends representing a return on ownership interest (rather than, *e.g.*, an adjusted level of payment being based on the referrals). Nor may B pay C anything of value for the referral.

10. *Facts:* A is a real estate broker who refers business to its affiliate title company B. A makes all required written disclosures to the homebuyer of the arrangement and estimated charges and the homebuyer is not required to use B. B refers or contracts out business to C who does all the title work and splits the fee with B. B passes its fee to A in the form of dividends, a return on ownership interest.

Comments: The relationship between A and B is an affiliated business arrangement. However, the affiliated business arrangement exemption does not provide exemption between an affiliated entity, B, and a third party, C. Here, B is a mere "shell" and provides no substantive services for its portion of the fee. The arrangement between B and C would be in violation of section 8(a) and (b). Even if B had an affiliate relationship with C, the required exemption criteria have not been met and the relationship would be subject to section 8.

11. *Facts:* A, a mortgage lender is affiliated with B, a title company, and C, an escrow company and offers consumers a package of mortgage title and escrow services at a discount from the prices at which such services

would be sold if purchased separately. Neither A, B, nor C, requires consumers to purchase the services of their sister companies and each company sells such services separately and as part of the package. A also pays its employees (i.e., loan officers, secretaries, etc.) a bonus for each loan, title insurance or closing that A's employees generate for A, B, or C respectively. A pays such employee bonuses out of its own funds and receives no payments or reimbursements for such bonuses from B or C. At or before the time that customers are told by A or its employees about the services offered by B and C and/of the package of services that is available, the customers are provided with an affiliated business disclosure form.

Comments: A's selling of a package of settlement services at a discount to a settlement service purchaser does not violate section 8 of RESPA. A's employees are making appropriate affiliated business disclosures and since the services are available separately and as part of a package, there is not "required use" of the additional services. A's payments of bonuses to its employees for the referral of business to A or A's affiliates, B and C, are exempt from section 8 under section 3500.14(g)(1). However, if B or C reimbursed A for any bonuses that A paid to its employees for referring business to B or C, such reimbursements would violate section 8. Similarly, if B or C paid bonuses to A's employees directly for generating business for them, such payments would violate section 8.

12. *Facts:* A, a real estate broker, is affiliated with B, a mortgage lender, and C, a title agency. A employs F to advise and assist any customers of A who have executed sales contracts regarding mortgage loans and title insurance. F collects and transmits (by computer, fax, mail, or other means) loan applications or other information to B and C for processing. A pays F a small salary and a bonus for every loan closed with B or title insurance issued with C. F furnishes the controlled business disclosure to consumers at the time of each referral. F receives no other compensation from the real estate or mortgage transaction and performs no settlement services in any transaction. At the end of each of A's fiscal years, M, a managerial employee of A, receives a \$1,000 bonus if 20% of the consumers who purchase a home through A close a loan on the home with B and have the title issued by C. During the year, M acted as a real estate agent for his neighbor and received a real estate sales commission for selling his neighbor's home.

Comments: Under §3500.14(g)(1), employers may pay their own *bona fide* employees for generating business for their employer (§3500.14(g)(1)(vii)). Employers may also pay their own *bona fide* employees for generating business for their affiliate business entities (§3500.14(g)(1)(ix)), as long as the employees

do not perform settlement services in any transaction and disclosure is made. This permits a company to employ a person whose primary function is to market the employer's or its affiliate's settlement services (frequently referred to as a Financial Services Representative, or "FSR"). An FSR may not perform any settlement services including, for example, those services of a real estate agent, loan processor, settlement agent, attorney, or mortgage broker. In accordance with the terms of the exemption at §3500.14(g)(1)(ix), the marketing of a settlement service or product of an affiliated entity, including the collection and conveyance of information or the taking of an application or order for the services of an affiliated entity, does not constitute the performance of a settlement service. Under the exemption, marketing of a settlement service or product also may include incidental communications with the consumer after the application or order, such as providing the consumer with information about the status of an application or order; marketing may not include serving as the ongoing point of contact for coordinating the delivery and provision of settlement services.

Thus, in the circumstances described, F and M may receive the additional compensation without violating RESPA.

Also, employers may pay managerial employees compensation in the form of bonuses based on a percentage of transactions completed by an affiliated company (frequently called a "capture rate"), as long as the payment is not directly calculated as a multiple of the number or value of the referrals. 24 CFR 3500.14(g)(1)(viii). A managerial employee who receives compensation for performing settlement services in three or fewer transactions in any calendar year "does not routinely" deal directly with the consumer and is not precluded from receiving managerial compensation.

13. *Facts.* A is a mortgage broker who provides origination services to submit a loan to a Lender for approval. The mortgage broker charges the borrower a uniform fee for the total origination services, as well as a direct up-front charge for reimbursement of credit reporting, appraisal services or similar charges.

Comment. The mortgage broker's fee must be itemized in the Good Faith Estimate and on the HUD-1 Settlement Statement. Other charges which are paid for by the borrower and paid in advance are listed as P.O.C. on the HUD-1 Settlement Statement, and reflect the actual provider charge for such services. Also, any other fee or payment received by the mortgage broker from either the lender or the borrower arising from the

initial funding transaction, including a servicing release premium or yield spread premium, is to be noted on the Good Faith Estimate and listed in the 800 series of the HUD-1 Settlement Statement.

14. *Facts.* A is a dealer in home improvements who has established funding arrangements with several lenders. Customers for home improvements receive a proposed contract from A. The proposal requires that customers both execute forms authorizing a credit check and employment verification, and, frequently, execute a dealer consumer credit contract secured by a lien on the customer's (borrower's) 1- to 4-family residential property. Simultaneously with the completion and certification of the home improvement work, the note is assigned by the dealer to a funding lender.

Comments. The loan that is assigned to the funding lender is a loan covered by RESPA, when a lien is placed on the borrower's 1- to 4-family residential structure. The dealer loan or consumer credit contract originated by a dealer is also a RESPA-covered transaction, except when the dealer is not a "creditor" under the definition of "federally related mortgage loan" in §3500.2. The lender to whom the loan will be assigned is responsible for assuring that the lender or the dealer delivers to the borrower a Good Faith Estimate of closing costs consistent with Regulation X, and that the HUD-1 or HUD-1A Settlement Statement is used in conjunction with the settlement of the loan to be assigned. A dealer who, under §3500.2, is covered by RESPA as a creditor is responsible for the Good Faith Estimate of Closing Costs and the use of the appropriate settlement statement in connection with the loan.

[57 FR 49607, Nov. 2, 1992; 57 FR 56857, Dec. 1, 1992, as amended at 59 FR 6521, Feb. 10, 1994; 61 FR 13251, Mar. 26, 1996; 61 FR 29253, June 7, 1996; 61 FR 58476, Nov. 15, 1996]

EFFECTIVE DATE NOTE: At 61 FR 29253, June 7, 1996, appendix B to part 3500 was amended by revising Illustration 11, redesignating Illustrations 12 and 13 as Illustrations 13 and 14, respectively, and adding a new Illustration 12, effective Oct. 7, 1996. At 61 FR 51782, Oct. 4, 1996, the effective date was delayed until further notice. For the convenience of the user, the revised text is set forth as follows:

APPENDIX B TO PART 3500—ILLUSTRATIONS OF REQUIREMENTS OF RESPA

* * * * *

11. *Facts:* A, a mortgage lender, is affiliated with B, a title company, and C, an escrow company, and offers consumers a package of mortgage, title, and escrow services at a discount from the prices at which such services would be sold if purchased separately. A, B,

and C are subsidiaries of H, a holding company, which also controls a retail stock brokerage firm, D. None of A, B, or C requires consumers to purchase the services of its sister companies, and each company sells such services separately and as part of the package. A also pays an employee T, a full-time bank teller who does not perform settlement services, a bonus for each loan, title insurance binder, or closing that T generates for A, B, or C. A pays T these bonuses out of A's own funds and receives no reimbursements for these bonuses from B, C, or H. At the time that T refers customers to B and C, T provides the customers with a disclosure using the controlled business arrangement disclosure format. Also, Z, a stockbroker employee of D, occasionally refers her customers to A, B, or C; gives a statement in the controlled business disclosure format; and receives a payment from D for each referral.

Comments: Selling a package of settlement services at a discount is not prohibited by RESPA, consistent with the definition of "required use" in 24 CFR 3500.2. Also, A is always allowed to compensate its own employees for business generated for A's company. Here, A may also compensate T, an employee who does not perform settlement services in this or any transaction, for referring business to a business entity in an affiliate relationship with A. Z, who does not perform settlement services in this or any transaction, can also be compensated by D, but not by anyone else. Employees who perform settlement services cannot be compensated for referrals to other settlement service providers. None of the entities in an affiliated relationship with each other may pay for referrals received from an affiliate's employees. Sections 3500.15(b)(3)(i)(A) and (B) set forth the permissible exchanges of funds between controlled business entities. In all circumstances described a statement in the controlled business disclosure format must be provided to a potential consumer at or before the time that the referral is made.

* * * * *

APPENDIX C TO PART 3500—INSTRUCTIONS FOR COMPLETING GOOD FAITH ESTIMATE (GFE) FORM

The following are instructions for completing the GFE required under section 5 of RESPA and 24 CFR 3500.7 of the Department of Housing and Urban Development regulations. The standardized form set forth in this Appendix is the required GFE form and must be provided exactly as specified. The instructions for completion of the GFE are primarily for the benefit of the loan originator who prepares the form and need not be transmitted to the borrower(s) as an integral part

of the GFE. The required standardized GFE form must be prepared completely and accurately. A separate GFE must be provided for each loan where a transaction will involve more than one mortgage loan.

General Instructions

The loan originator preparing the GFE may fill in information and amounts on the form by typewriter, hand printing, computer printing, or any other method producing clear and legible results. Under these instructions, the "form" refers to the required standardized GFE form. Although the standardized GFE is a prescribed form, Blocks 3, 6, and 11 on page 2 may be adapted for use in particular loan situations, so that additional lines may be inserted there, and unused lines may be deleted.

All fees for categories of charges shall be disclosed in U.S. dollar and cent amounts.

Specific Instructions

Page 1

Top of the Form—The loan originator must enter its name, business address, telephone number, and email address, if any, on the top of the form, along with the applicant's name, the address or location of the property for which financing is sought, and the date of the GFE.

"Purpose."—This section describes the general purpose of the GFE as well as additional information available to the applicant.

"Shopping for your loan."—This section requires no loan originator action.

"Important dates."—This section briefly states important deadlines after which the loan terms that are the subject of the GFE may not be available to the applicant. In Line 1, the loan originator must state the date and, if necessary, time until which the interest rate for the GFE will be available. In Line 2, the loan originator must state the date until which the estimate of all other settlement charges for the GFE will be available. This date must be at least 10 business days from the date of the GFE. In Line 3, the loan originator must state how many calendar days within which the applicant must go to settlement once the interest rate is locked. In Line 4, the loan originator must state how many calendar days prior to settlement the interest rate would have to be locked, if applicable.

"Summary of your loan."—In this section, for all loans the loan originator must fill in, where indicated:

- (i) The initial loan amount;
- (ii) The loan term; and
- (iii) The initial interest rate.

The loan originator must fill in the initial monthly amount owed for principal, interest, and any mortgage insurance. The amount shown must be the greater of: (1) The required monthly payment for principal and

interest for the first regularly scheduled payment, plus any monthly mortgage insurance payment; or (2) the accrued interest for the first regularly scheduled payment, plus any monthly mortgage insurance payment.

The loan originator must indicate whether the interest rate can rise, and, if it can, must insert the maximum rate to which it can rise over the life of the loan. The loan originator must also indicate the period of time after which the interest rate can first change.

The loan originator must indicate whether the loan balance can rise even if the borrower makes payments on time, for example in the case of a loan with negative amortization. If it can, the loan originator must insert the maximum amount to which the loan balance can rise over the life of the loan. For federal, state, local, or tribal housing programs that provide payment assistance, any repayment of such program assistance should be excluded from consideration in completing this item. If the loan balance will increase only because escrow items are being paid through the loan balance, the loan originator is not required to check the box indicating that the loan balance can rise.

The loan originator must indicate whether the monthly amount owed for principal, interest, and any mortgage insurance can rise even if the borrower makes payments on time. If the monthly amount owed can rise even if the borrower makes payments on time, the loan originator must indicate the period of time after which the monthly amount owed can first change, the maximum amount to which the monthly amount owed can rise at the time of the first change, and the maximum amount to which the monthly amount owed can rise over the life of the loan. The amount used for the monthly amount owed must be the greater of: (1) The required monthly payment for principal and interest for that month, plus any monthly mortgage insurance payment; or (2) the accrued interest for that month, plus any monthly mortgage insurance payment.

The loan originator must indicate whether the loan includes a prepayment penalty, and, if so, the maximum amount that it could be.

The loan originator must indicate whether the loan requires a balloon payment and, if so, the amount of the payment and in how many years it will be due.

"Escrow account information."—The loan originator must indicate whether the loan includes an escrow account for property taxes and other financial obligations. The amount shown in the "Summary of your loan" section for "Your initial monthly amount owed for principal, interest, and any mortgage insurance" must be entered in the space for the monthly amount owed in this section.

"Summary of your settlement charges."—On this line, the loan originator must state the

Adjusted Origination Charges from subtotal A of page 2, the Charges for All Other Settlement Services from subtotal B of page 2, and the Total Estimated Settlement Charges from the bottom of page 2.

Page 2

“Understanding your estimated settlement charges.”—This section details 11 settlement cost categories and amounts associated with the mortgage loan. For purposes of determining whether a tolerance has been met, the amount on the GFE should be compared with the total of any amounts shown on the HUD-1 in the borrower's column and any amounts paid outside closing by or on behalf of the borrower.

Your Adjusted Origination Charges”

Block 1, *“Our origination charge.”*—The loan originator must state here all charges that all loan originators involved in this transaction will receive, except for any charge for the specific interest rate chosen (points). A loan originator may not separately charge any additional fees for getting this loan, including for application, processing, or underwriting. The amount stated in Block 1 is subject to zero tolerance, i.e., the amount may not increase at settlement.

Block 2, *“Your credit or charge (points) for the specific interest rate chosen.”*—For transactions involving mortgage brokers, the mortgage broker must indicate through check boxes whether there is a credit to the borrower for the interest rate chosen on the loan, the interest rate, and the amount of the credit, or whether there is an additional charge (points) to the borrower for the interest rate chosen on the loan, the interest rate, and the amount of that charge. Only one of the boxes may be checked; a credit and charge cannot occur together in the same transaction.

For transactions without a mortgage broker, the lender may choose not to separately disclose in this block any credit or charge for the interest rate chosen on the loan; however, if this block does not include any positive or negative figure, the lender must check the first box to indicate that “The credit or charge for the interest rate you have chosen” is included in “Our origination charge” above (see Block 1 instructions above), must insert the interest rate, and must also insert “0” in Block 2. Only one of the boxes may be checked; a credit and charge cannot occur together in the same transaction.

For a mortgage broker, the credit or charge for the specific interest rate chosen is the net payment to the mortgage broker from the lender (i.e., the sum of all payments to the mortgage broker from the lender, including payments based on the loan amount, a flat rate, or any other computation, and in

a table funded transaction, the loan amount less the price paid for the loan by the lender). When the net payment to the mortgage broker from the lender is positive, there is a credit to the borrower and it is entered as a negative amount in Block 2 of the GFE. When the net payment to the mortgage broker from the lender is negative, there is a charge to the borrower and it is entered as a positive amount in Block 2 of the GFE. If there is no net payment (i.e., the credit or charge for the specific interest rate chosen is zero), the mortgage broker must insert “0” in Block 2 and may check either the box indicating there is a credit of “0” or the box indicating there is a charge of “0”.

The amount stated in Block 2 is subject to zero tolerance while the interest rate is locked, i.e., any credit for the interest rate chosen cannot decrease in absolute value terms and any charge for the interest rate chosen cannot increase. (Note: An increase in the credit is allowed since this increase is a reduction in cost to the borrower. A decrease in the credit is not allowed since it is an increase in cost to the borrower.)

Line A, *“Your Adjusted Origination Charges.”*—The loan originator must add the numbers in Blocks 1 and 2 and enter this subtotal at highlighted Line A. The subtotal at Line A will be a negative number if there is a credit in Block 2 that exceeds the charge in Block 1. The amount stated in Line A is subject to zero tolerance while the interest rate is locked.

In the case of “no cost” loans, where “no cost” refers only to the loan originator's fees, Line A must show a zero charge as the adjusted origination charge. In the case of “no cost” loans where “no cost” encompasses third party fees as well as the upfront payment to the loan originator, all of the third party fees listed in Block 3 through Block 11 to be paid for by the loan originator (or borrower, if any) must be itemized and listed on the GFE. The credit for the interest rate chosen must be large enough that the total for Line A will result in a negative number to cover the third party fees.

“Your Charges for All Other Settlement Services”

There is a 10 percent tolerance applied to the sum of the prices of each service listed in Block 3, Block 4, Block 5, Block 6, and Block 7, where the loan originator requires the use of a particular provider or the borrower uses a provider selected or identified by the loan originator. Any services in Block 4, Block 5, or Block 6 for which the borrower selects a provider other than one identified by the loan originator are not subject to any tolerance and, at settlement, would not be included in the sum of the charges on which the 10 percent tolerance is based. Where a loan originator permits a borrower to shop for third party settlement services, the loan

originator must provide the borrower with a written list of settlement services providers at the time of the GFE, on a separate sheet of paper.

Block 3, “*Required services that we select.*”—In this block, the loan originator must identify each third party settlement service required and selected by the loan originator (excluding title services), along with the estimated price to be paid to the provider of each service. Examples of such third party settlement services might include provision of credit reports, appraisals, flood checks, tax services, and any upfront mortgage insurance premium. The loan originator must identify the specific required services and provide an estimate of the price of each service. Loan originators are also required to add the individual charges disclosed in this block and place that total in the column of this block. The charge shown in this block is subject to an overall 10 percent tolerance as described above.

Block 4, “*Title services and lender’s title insurance.*”—In this block, the loan originator must state the estimated total charge for third party settlement service providers for all closing services, regardless of whether the providers are selected or paid for by the borrower, seller, or loan originator. The loan originator must also include any lender’s title insurance premiums, when required, regardless of whether the provider is selected or paid for by the borrower, seller, or loan originator. All fees for title searches, examinations, and endorsements, for example, would be included in this total. The charge shown in this block is subject to an overall 10 percent tolerance as described above.

Block 5, “*Owner’s title insurance.*”—In this block, for all purchase transactions the loan originator must provide an estimate of the charge for the owner’s title insurance and related endorsements, regardless of whether the providers are selected or paid for by the borrower, seller, or loan originator. For non-purchase transactions, the loan originator may enter “NA” or “Not Applicable” in this Block. The charge shown in this block is subject to an overall 10 percent tolerance as described above.

Block 6, “*Required services that you can shop for.*”—In this block, the loan originator must identify each third party settlement service required by the loan originator where the borrower is permitted to shop for and select the settlement service provider (excluding title services), along with the estimated charge to be paid to the provider of each service. The loan originator must identify the specific required services (e.g., survey, pest inspection) and provide an estimate of the charge of each service. The loan originator must also add the individual charges disclosed in this block and place the total in the column of this block. The charge shown

in this block is subject to an overall 10 percent tolerance as described above.

Block 7, “*Government recording charges.*”—In this block, the loan originator must estimate the state and local government fees for recording the loan and title documents that can be expected to be charged at settlement. The charge shown in this block is subject to an overall 10 percent tolerance as described above.

Block 8, “*Transfer taxes.*”—In this block, the loan originator must estimate the sum of all state and local government fees on mortgages and home sales that can be expected to be charged at settlement, based upon the proposed loan amount or sales price and on the property address. A zero tolerance applies to the sum of these estimated fees.

Block 9, “*Initial deposit for your escrow account.*”—In this block, the loan originator must estimate the amount that it will require the borrower to place into a reserve or escrow account at settlement to be applied to recurring charges for property taxes, homeowner’s and other similar insurance, mortgage insurance, and other periodic charges. The loan originator must indicate through check boxes if the reserve or escrow account will cover future payments for all tax, all hazard insurance, and other obligations that the loan originator requires to be paid as they fall due. If the reserve or escrow account includes some, but not all, property taxes or hazard insurance, or if it includes mortgage insurance, the loan originator should check “other” and then list the items included.

Block 10, “*Daily interest charges.*”—In this block, the loan originator must estimate the total amount that will be due at settlement for the daily interest on the loan from the date of settlement until the first day of the first period covered by scheduled mortgage payments. The loan originator must also indicate how this total amount is calculated by providing the amount of the interest charges per day and the number of days used in the calculation, based on a stated projected closing date.

Block 11, “*Homeowner’s insurance.*”—The loan originator must estimate in this block the total amount of the premiums for any hazard insurance policy and other similar insurance, such as fire or flood insurance that must be purchased at or before settlement to meet the loan originator’s requirements. The loan originator must also separately indicate the nature of each type of insurance required along with the charges. To the extent a loan originator requires that such insurance be part of an escrow account, the amount of the initial escrow deposit must be included in Block 9.

Line B, “*Your Charges for All Other Settlement Services.*”—The loan originator must add the numbers in Blocks 3 through 11 and

enter this subtotal in the column at highlighted Line B.

Line A+B, “*Total Estimated Settlement Charges.*”—The loan originator must add the subtotals in the right-hand column at highlighted Lines A and B and enter this total in the column at highlighted Line A+B.

Page 3

“Instructions”

“Understanding which charges can change at settlement.”—This section informs the applicant about which categories of settlement charges can increase at closing, and by how much, and which categories of settlement charges cannot increase at closing. This section requires no loan originator action.

“Using the tradeoff table.”—This section is designed to make borrowers aware of the relationship between their total estimated settlement charges on one hand, and the interest rate and resulting monthly payment on the other hand. The loan originator must complete the left hand column using the loan amount, interest rate, monthly payment figure, and the total estimated settlement charges from page 1 of the GFE. The loan originator, at its option, may provide the borrower with the same information for two alternative loans, one with a higher interest rate, if available, and one with a lower interest rate, if available, from the loan

originator. The loan originator should list in the tradeoff table only alternative loans for which it would presently issue a GFE based on the same information the loan originator considered in issuing this GFE. The alternative loans must use the same loan amount and be otherwise identical to the loan in the GFE. The alternative loans must have, for example, the identical number of payment periods; the same margin, index, and adjustment schedule if the loans are adjustable rate mortgages; and the same requirements for prepayment penalty and balloon payments. If the loan originator fills in the tradeoff table, the loan originator must show the borrower the loan amount, alternative interest rate, alternative monthly payment, the change in the monthly payment from the loan in this GFE to the alternative loan, the change in the total settlement charges from the loan in this GFE to the alternative loan, and the total settlement charges for the alternative loan. If these options are available, an applicant may request a new GFE, and a new GFE must be provided by the loan originator.

“Using the shopping chart.”—This chart is a shopping tool to be provided by the loan originator for the borrower to complete, in order to compare GFEs.

“If your loan is sold in the future.”—This section requires no loan originator action.



OMB Approval No. 2502-0265

Good Faith Estimate (GFE)

Name of Originator	Borrower
Originator Address	Property Address
Originator Phone Number	
Originator Email	Date of GFE

Purpose This GFE gives you an estimate of your settlement charges and loan terms if you are approved for this loan. For more information, see HUD's *Special Information Booklet* on settlement charges, your *Truth-in-Lending Disclosures*, and other consumer information at www.hud.gov/respa. If you decide you would like to proceed with this loan, contact us.

Shopping for your loan Only you can shop for the best loan for you. Compare this GFE with other loan offers, so you can find the best loan. Use the shopping chart on page 3 to compare all the offers you receive.

- Important dates**
1. The interest rate for this GFE is available through []. After this time, the interest rate, some of your loan Origination Charges, and the monthly payment shown below can change until you lock your interest rate.
 2. This estimate for all other settlement charges is available through [].
 3. After you lock your interest rate, you must go to settlement within [] days (your rate lock period) to receive the locked interest rate.
 4. You must lock the interest rate at least [] days before settlement.

Summary of your loan

Your initial loan amount is	\$
Your loan term is	years
Your initial interest rate is	%
Your initial monthly amount owed for principal, interest, and any mortgage insurance is	\$ per month
Can your interest rate rise?	<input type="checkbox"/> No <input type="checkbox"/> Yes, it can rise to a maximum of % The first change will be in
Even if you make payments on time, can your loan balance rise?	<input type="checkbox"/> No <input type="checkbox"/> Yes, it can rise to a maximum of \$
Even if you make payments on time, can your monthly amount owed for principal, interest, and any mortgage insurance rise?	<input type="checkbox"/> No <input type="checkbox"/> Yes, the first increase can be in and the monthly amount owed can rise to \$ The maximum it can ever rise to is \$
Does your loan have a prepayment penalty?	<input type="checkbox"/> No <input type="checkbox"/> Yes, your maximum prepayment penalty is \$
Does your loan have a balloon payment?	<input type="checkbox"/> No <input type="checkbox"/> Yes, you have a balloon payment of \$ due in years.

Escrow account information

Some lenders require an escrow account to hold funds for paying property taxes or other property-related charges in addition to your monthly amount owed of \$ [].

Do we require you to have an escrow account for your loan?

No, you do not have an escrow account. You must pay these charges directly when due.

Yes, you have an escrow account. It may or may not cover all of these charges. Ask us.

Summary of your settlement charges

A	Your Adjusted Origination Charges (See page 2)	\$
B	Your Charges for All Other Settlement Services (See page 2)	\$
A + B	Total Estimated Settlement Charges	\$

Understanding your estimated settlement charges

Some of these charges can change at settlement. See the top of page 3 for more information.

Your Adjusted Origination Charges								
1. Our origination charge This charge is for getting this loan for you.								
2. Your credit or charge (points) for the specific interest rate chosen <input type="checkbox"/> The credit or charge for the interest rate of [] % is included in "Our origination charge." (See item 1 above.) <input type="checkbox"/> You receive a credit of \$ [] for this interest rate of [] %. This credit reduces your settlement charges. <input type="checkbox"/> You pay a charge of \$ [] for this interest rate of [] %. This charge (points) increases your total settlement charges. The tradeoff table on page 3 shows that you can change your total settlement charges by choosing a different interest rate for this loan.								
A	Your Adjusted Origination Charges	\$						
Your Charges for All Other Settlement Services								
3. Required services that we select These charges are for services we require to complete your settlement. We will choose the providers of these services. <table border="1"> <thead> <tr> <th>Service</th> <th>Charge</th> </tr> </thead> <tbody> <tr> <td> </td> <td> </td> </tr> <tr> <td> </td> <td> </td> </tr> </tbody> </table>		Service	Charge					
Service	Charge							
4. Title services and lender's title insurance This charge includes the services of a title or settlement agent, for example, and title insurance to protect the lender, if required.								
5. Owner's title insurance You may purchase an owner's title insurance policy to protect your interest in the property.								
6. Required services that you can shop for These charges are for other services that are required to complete your settlement. We can identify providers of these services or you can shop for them yourself. Our estimates for providing these services are below. <table border="1"> <thead> <tr> <th>Service</th> <th>Charge</th> </tr> </thead> <tbody> <tr> <td> </td> <td> </td> </tr> <tr> <td> </td> <td> </td> </tr> </tbody> </table>		Service	Charge					
Service	Charge							
7. Government recording charges These charges are for state and local fees to record your loan and title documents.								
8. Transfer taxes These charges are for state and local fees on mortgages and home sales.								
9. Initial deposit for your escrow account This charge is held in an escrow account to pay future recurring charges on your property and includes <input type="checkbox"/> all property taxes, <input type="checkbox"/> all insurance, and <input type="checkbox"/> other [] .								
10. Daily interest charges This charge is for the daily interest on your loan from the day of your settlement until the first day of the next month or the first day of your normal mortgage payment cycle. This amount is \$ [] per day for [] days (if your settlement is []).								
11. Homeowner's insurance This charge is for the insurance you must buy for the property to protect from a loss, such as fire. <table border="1"> <thead> <tr> <th>Policy</th> <th>Charge</th> </tr> </thead> <tbody> <tr> <td> </td> <td> </td> </tr> </tbody> </table>		Policy	Charge					
Policy	Charge							
B	Your Charges for All Other Settlement Services	\$						
A + B	Total Estimated Settlement Charges	\$						



Instructions

Understanding which charges can change at settlement

This GFE estimates your settlement charges. At your settlement, you will receive a HUD-1, a form that lists your actual costs. Compare the charges on the HUD-1 with the charges on this GFE. Charges can change if you select your own provider and do not use the companies we identify. (See below for details.)

These charges cannot increase at settlement:	The total of these charges can increase up to 10% at settlement:	These charges can change at settlement:
<ul style="list-style-type: none"> ■ Our origination charge ■ Your credit or charge (points) for the specific interest rate chosen (after you lock in your interest rate) ■ Your adjusted origination charges (after you lock in your interest rate) ■ Transfer taxes 	<ul style="list-style-type: none"> ■ Required services that we select ■ Title services and lender's title insurance (if we select them or you use companies we identify) ■ Owner's title insurance (if you use companies we identify) ■ Required services that you can shop for (if you use companies we identify) ■ Government recording charges 	<ul style="list-style-type: none"> ■ Required services that you can shop for (if you do not use companies we identify) ■ Title services and lender's title insurance (if you do not use companies we identify) ■ Owner's title insurance (if you do not use companies we identify) ■ Initial deposit for your escrow account ■ Daily interest charges ■ Homeowner's insurance

Using the tradeoff table

In this GFE, we offered you this loan with a particular interest rate and estimated settlement charges. However:

- If you want to choose this same loan with **lower settlement charges**, then you will have a **higher interest rate**.
- If you want to choose this same loan with a **lower interest rate**, then you will have **higher settlement charges**.

If you would like to choose an available option, you must ask us for a new GFE.

Loan originators have the option to complete this table. Please ask for additional information if the table is not completed.

	The loan in this GFE	The same loan with lower settlement charges	The same loan with a lower interest rate
Your initial loan amount	\$	\$	\$
Your initial interest rate ¹	%	%	%
Your initial monthly amount owed	\$	\$	\$
Change in the monthly amount owed from this GFE	No change	You will pay \$ more every month	You will pay \$ less every month
Change in the amount you will pay at settlement with this interest rate	No change	Your settlement charges will be reduced by \$	Your settlement charges will increase by \$
How much your total estimated settlement charges will be	\$	\$	\$

¹ For an adjustable rate loan, the comparisons above are for the initial interest rate before adjustments are made.

Using the shopping chart

Use this chart to compare GFEs from different loan originators. Fill in the information by using a different column for each GFE you receive. By comparing loan offers, you can shop for the best loan.

	This loan	Loan 2	Loan 3	Loan 4
Loan originator name				
Initial loan amount				
Loan term				
Initial interest rate				
Initial monthly amount owed				
Rate lock period				
Can interest rate rise?				
Can loan balance rise?				
Can monthly amount owed rise?				
Prepayment penalty?				
Balloon payment?				
Total Estimated Settlement Charges				

If your loan is sold in the future

Some lenders may sell your loan after settlement. Any fees lenders receive in the future cannot change the loan you receive or the charges you paid at settlement.



APPENDIX D TO PART 3500—AFFILIATED BUSINESS ARRANGEMENT DISCLOSURE STATEMENT FORMAT

Affiliated Business Arrangement Disclosure Statement Format

Notice

To: _____ Property: _____

From: _____ Date: _____
(Entity Making Statement)

This is to give you notice that _____ [referring party] has a business relationship with _____ [settlement services provider(s)]. [Describe the nature of the relationship between the referring party and the provider(s), including percentage of ownership interest, if applicable.] Because of this relationship, this referral may provide _____ [referring party] a financial or other benefit.

[A.] Set forth below is the estimated charge or range of charges for the settlement services listed. You are NOT required to use the listed provider(s) as a condition for [settlement of your loan on] [or] [purchase, sale, or refinance of] the subject property. THERE ARE FREQUENTLY OTHER SETTLEMENT SERVICE PROVIDERS AVAILABLE WITH SIMILAR SERVICES. YOU ARE FREE TO SHOP AROUND TO DETERMINE THAT YOU ARE RECEIVING THE BEST SERVICES AND THE BEST RATE FOR THESE SERVICES.

<u>[provider and settlement service]</u>	<u>[charge or range of charges]</u>
_____	_____
_____	_____

[B.] Set forth below is the estimated charge or range of charges for the settlement services of an attorney, credit reporting agency, or real estate appraiser that we, as your lender, will require you to use, as a condition of your loan on this property, to represent our interests in the transaction.

<u>[provider and settlement service]</u>	<u>[charge or range of charges]</u>
_____	_____
_____	_____

ACKNOWLEDGMENT

I/we have read this disclosure form, and understand that _____ [referring party] is referring me/us to purchase the above-described settlement service(s) and may receive a financial or other benefit as the result of this referral.

Signature

[INSTRUCTIONS TO PREPARER:] [Use paragraph A for referrals other than those by a lender to an attorney, a credit reporting agency, or a real estate appraiser that a lender is requiring a borrower to use to represent the lender's interests in the transaction. Use paragraph B for those referrals to an attorney, credit reporting agency, or real estate appraiser that a lender is requiring a borrower to use to represent the lender's interests in the transaction. When applicable, use both paragraphs. Specific timing rules for delivery of the affiliated business disclosure statement are set forth in 24 CFR 3500.15(b)(1) of Regulation X). These INSTRUCTIONS TO PREPARER should not appear on the statement.]

Office of Asst. Sec. for Housing, HUD

Pt. 3500, App. E

APPENDIX E TO PART 3500—ARITHMETIC STEPS

STEP 2—ADJUSTED TRIAL BALANCE—Continued
[Increase monthly balances to eliminate negative balances]

I. Example Illustrating Aggregate Analysis:

ASSUMPTIONS:

Disbursements:
 \$360 for school taxes disbursed on September 20
 \$1,200 for county property taxes:
 \$500 disbursed on July 25
 \$700 disbursed on December 10
 Cushion: One-sixth of estimated annual disbursements
 Settlement: May 15
 First Payment: July 1

STEP 1—INITIAL TRIAL BALANCE

	Aggregate		
	pmt	disb	bal
Jun	0	0	0
Jul	130	500	-370
Aug	130	0	-240
Sep	130	360	-470
Oct	130	0	-340
Nov	130	0	-210
Dec	130	700	-780
Jan	130	0	-650
Feb	130	0	-520
Mar	130	0	-390
Apr	130	0	-260
May	130	0	-130
Jun	130	0	0

STEP 2—ADJUSTED TRIAL BALANCE

[Increase monthly balances to eliminate negative balances]

	Aggregate		
	pmt	disb	bal
Jun	0	0	780
Jul	130	500	410
Aug	130	0	540
Sep	130	360	310
Oct	130	0	440
Nov	130	0	570

STEP 1—INITIAL TRIAL BALANCE

	Single-item					
	Taxes			School taxes		
	pmt	disb	bal	pmt	disb	bal
June	0	0	0	0	0	0
July	100	500	-400	30	0	30
August	100	0	-300	30	0	60
September	100	0	-200	30	360	-270
October	100	0	-100	30	0	-240
November	100	0	0	30	0	-210
December	100	700	-600	30	0	-180
January	100	0	-500	30	0	-150
February	100	0	-400	30	0	-120
March	100	0	-300	30	0	-90
April	100	0	-200	30	0	-60
May	100	0	-100	30	0	-30
June	100	0	0	30	0	0

	Aggregate		
	pmt	disb	bal
Dec	130	700	0
Jan	130	0	130
Feb	130	0	260
Mar	130	0	390
Apr	130	0	520
May	130	0	650
Jun	130	0	780

STEP 3—TRIAL BALANCE WITH CUSHION

	Aggregate		
	pmt	disb	bal
Jun	0	0	1040
Jul	130	500	670
Aug	130	0	800
Sep	130	360	570
Oct	130	0	700
Nov	130	0	830
Dec	130	700	260
Jan	130	0	390
Feb	130	0	520
Mar	130	0	650
Apr	130	0	780
May	130	0	910
Jun	130	0	1040

II. Example Illustrating Single-Item Analysis

ASSUMPTIONS:

Disbursements:
 \$360 for school taxes disbursed on September 20
 \$1,200 for county property taxes:
 \$500 disbursed on July 25
 \$700 disbursed on December 10
 Cushion: One-sixth of estimated annual disbursements
 Settlement: May 15
 First Payment: July 1

STEP 2—ADJUSTED TRIAL BALANCE (INCREASE MONTHLY BALANCES TO ELIMINATE NEGATIVE BALANCES)

	Single-item					
	Taxes			School taxes		
	pmt	disb	bal	pmt	disb	bal
Jun	0	0	600	0	0	270
Jul	100	500	200	30	0	300
Aug	100	0	300	30	0	330
Sep	100	0	400	30	360	0
Oct	100	0	500	30	0	30
Nov	100	0	600	30	0	60
Dec	100	700	0	30	0	90
Jan	100	0	100	30	0	120
Feb	100	0	200	30	0	150
Mar	100	0	300	30	0	180
Apr	100	0	400	30	0	210
May	100	0	500	30	0	240
Jun	100	0	600	30	0	270

STEP 3—TRIAL BALANCE WITH CUSHION

	Single-Item					
	Taxes			School taxes		
	pmt	disb	bal	pmt	disb	bal
Jun	0	0	800	0	0	330
Jul	100	500	400	30	0	360
Aug	100	0	500	30	0	390
Sep	100	0	600	30	360	60
Oct	100	0	700	30	0	90
Nov	100	0	800	30	0	120
Dec	100	700	200	30	0	150
Jan	100	0	300	30	0	180
Feb	100	0	400	30	0	210
Mar	100	0	500	30	0	240
Apr	100	0	600	30	0	270
May	100	0	700	30	0	300
Jun	100	0	800	30	0	330

[59 FR 53908, Oct. 26, 1994, as amended at 60 FR 8816, Feb. 15, 1995. Redesignated at 61 FR 58479, Nov. 15, 1996; 73 FR 68259, Nov. 17, 2008]

APPENDIX MS-1 TO PART 3500

[Sample language; use business stationery or similar heading]
[Date]

SERVICING DISCLOSURE STATEMENT NOTICE TO FIRST LIEN MORTGAGE LOAN APPLICANTS: THE RIGHT TO COLLECT YOUR MORTGAGE LOAN PAYMENTS MAY BE TRANSFERRED

You are applying for a mortgage loan covered by the Real Estate Settlement Procedures Act (RESPA) (12 U.S.C. 2601 *et seq.*). RESPA gives you certain rights under Federal law. This statement describes whether the servicing for this loan may be transferred to a different loan servicer. "Servicing" refers to collecting your principal, interest, and escrow payments, if any, as well as sending any monthly or annual statements, tracking account balances, and handling other aspects of your loan. You will be given advance notice before a transfer occurs.

Servicing Transfer Information

[We may assign, sell, or transfer the servicing of your loan while the loan is outstanding.]
[or]

[We do not service mortgage loans of the type for which you applied. We intend to assign, sell, or transfer the servicing of your mortgage loan before the first payment is due.]
[or]

[The loan for which you have applied will be serviced at this financial institution and we do not intend to sell, transfer, or assign the servicing of the loan.]

[INSTRUCTIONS TO PREPARER: Insert the date and select the appropriate language under "Servicing Transfer Information." The model format may be annotated with further information that clarifies or enhances the model language.]

[73 FR 68259, Nov. 17, 2008]

APPENDIX MS-2 TO PART 3500

[Sample language; use business stationery or similar heading]

NOTICE OF ASSIGNMENT, SALE, OR TRANSFER OF SERVICING RIGHTS

You are hereby notified that the servicing of your mortgage loan, that is, the right to collect payments from you, is being assigned, sold or transferred from _____ to _____, effective _____.

The assignment, sale or transfer of the servicing of the mortgage loan does not affect any term or condition of the mortgage instruments, other than terms directly related to the servicing of your loan.

Except in limited circumstances, the law requires that your present servicer send you this notice at least 15 days before the effective date of transfer, or at closing. Your new servicer must also send you this notice no later than 15 days after this effective date or at closing. [In this case, all necessary information is combined in this one notice].

Your present servicer is _____. If you have any questions relating to the transfer of servicing from your present servicer call _____ [enter the name of an individual or department here] between _____ a.m. and _____ p.m. on the following days _____. This is a [toll-free] or [collect call] number.

Your new servicer will be _____.

The business address for your new servicer is: _____

The [toll-free] [collect call] telephone number of your new servicer is _____. If you have any questions relating to the transfer of servicing to your new servicer call _____ [enter the name of an individual or department here] at _____ [toll free or collect call telephone number] between _____ a.m. and _____ p.m. on the following days _____.

The date that your present servicer will stop accepting payments from you is _____. The date that your new servicer will start accepting payments from you is _____. Send all payments due on or after that date to your new servicer.

[Use this paragraph if appropriate; otherwise omit] The transfer of servicing rights may affect the terms of or the continued availability of mortgage life or disability insurance or any other type of optional insurance in the following manner:

and you should take the following action to maintain coverage:

You should also be aware of the following information, which is set out in more detail in Section 6 of the Real Estate Settlement Procedures Act (RESPA) (12 U.S.C. 2605):

During the 60-day period following the effective date of the transfer of the loan servicing, a loan payment received by your old servicer before its due date may not be treated by the new loan servicer as late, and a late fee may not be imposed on you.

Section 6 of RESPA (12 U.S.C. 2605) gives you certain consumer rights. If you send a "qualified written request" to your loan servicer concerning the servicing of your loan, your servicer must provide you with a written acknowledgment within 20 Business Days of receipt of your request. A "qualified written request" is a written correspondence, other than notice on a payment coupon or other payment medium supplied by the servicer, which includes your name and account number, and your reasons for the request. [If you want to send a "qualified written request" regarding the servicing of your loan, it must be sent to this address:

_____]

Not later than 60 Business Days after receiving your request, your servicer must make any appropriate corrections to your account, and must provide you with a written clarification regarding any dispute. During this 60-Business Day period, your servicer may not provide information to a consumer reporting agency concerning any overdue payment related to such period or qualified written request. However, this does not prevent the servicer from initiating foreclosure if proper grounds exist under the mortgage documents.

A Business Day is a day on which the offices of the business entity are open to the public for carrying on substantially all of its business functions.

Section 6 of RESPA also provides for damages and costs for individuals or classes of individuals in circumstances where servicers are shown to have violated the requirements of that Section. You should seek legal advice if you believe your rights have been violated.

[INSTRUCTIONS TO PREPARER: Delivery means placing the notice in the mail, first class postage prepaid, prior to 15 days before the effective date of transfer (transferor) or prior to 15 days after the effective date of transfer (transferee). However, this notice may be sent not more than 30 days after the effective date of the transfer of servicing rights if certain emergency business situations occur. See 24 CFR § 3500.21(d)(1)(ii). "Lender" may be substituted for "present servicer" where appropriate. These instructions should not appear on the format.]

PRESENT SERVICER [Signature not required]

Date

[and][or]

FUTURE SERVICER [Signature not required]

Date

[61 FR 13252, Mar. 26, 1996]

PART 3800—INVESTIGATIONS IN CONSUMER REGULATORY PRO- GRAMS

Sec.

3800.10 Scope of rules.

3800.20 Subpoenas in investigations.

3800.30 Subpoena enforcement in district court.

3800.40 Investigational proceedings.

3800.50 Rights of witnesses in investigational proceedings.

3800.60 Settlements.

AUTHORITY: 12 U.S.C. 2601 *et seq.*; 15 U.S.C. 1714; 42 U.S.C. 3535(d) and 5413.

SOURCE: 61 FR 10441, Mar. 13, 1996, unless otherwise noted.

§ 3800.10 Scope of rules.

This part applies to investigations and investigational proceedings undertaken by the Secretary, or the Secretary's designee, pursuant to the following:

(a) The Interstate Land Sales Full Disclosure Act, 15 U.S.C. 1701 *et seq.*;

(b) The National Manufactured Housing Construction and Safety Standards Act of 1974, 42 U.S.C. 5401 *et seq.*; and

(c) The Real Estate Settlement Procedures Act of 1974, 12 U.S.C. 2601 *et seq.*

§ 3800.20 Subpoenas in investigations.

(a) The Secretary may issue subpoenas relating to any matter under investigation. A subpoena may:

(1) Require testimony to be taken by interrogatories;

(2) Require the attendance and testimony of witnesses at a specific time and place;

(3) Require access to, examination of, and the right to copy documents; and

(4) Require the production of documents at a specific time and place.

(b) A subpoenaed person may petition the Secretary or the Secretary's designee to modify or withdraw a subpoena by filing the petition within 10 days after service of the subpoena. The petition may be in letter form, but must set forth the facts and law upon which the petition is based.

§ 3800.30 Subpoena enforcement in district court.

In the case of contumacy of a witness or a witness's refusal to obey a subpoena or order of the Secretary, the United States district court for the jurisdiction in which an investigation is carried on may issue an order requiring compliance with the subpoena. HUD headquarters in Washington, DC, is one of the locations in which the Secretary

§ 3800.40

24 CFR Ch. XX (4-1-11 Edition)

carries on investigations of its consumer regulatory programs.

§ 3800.40 Investigational proceedings.

(a) For the purpose of hearing the testimony of witnesses and receiving documents and other data relating to any subject under investigation, the Secretary, or the Secretary's designee, may conduct an investigational proceeding.

(b) The Secretary, or the Secretary's designee, ("presiding official") shall preside over the investigational proceeding. The proceeding shall be stenographically or mechanically reported. A transcript shall be a part of the record of the investigation.

(c) Unless the presiding official determines otherwise, investigational proceedings shall be public.

(d) The presiding official shall take all necessary action to regulate the course of the proceeding to avoid delay and to maintain order. If necessary to maintain order, the presiding official may exclude a witness or counsel from a proceeding. The Department may also take further action as permitted by statute.

§ 3800.50 Rights of witnesses in investigational proceedings.

(a) Any person who testifies at a public investigational proceeding shall be entitled, on payment of costs, to purchase a copy of a transcript of the testimony the person provided.

(b) In a nonpublic investigational proceeding, the presiding official may for good cause limit a witness to an inspection of the official transcript of that witness's testimony.

(c) Any person subpoenaed to appear at an investigational proceeding may be represented by counsel as follows:

(1) With respect to any question asked of a witness, a witness may obtain confidential advice from counsel;

(2) If a witness refuses to answer a question, counsel for the witness may briefly state the legal grounds for the refusal;

(3) Counsel for the witness may object to a question or a request for production of documents that is beyond the scope of the investigation or for which a privilege of the witness to refuse to answer may be invoked. In so doing, counsel for the witness may state briefly the grounds for the objection. Objections will be deemed continuing throughout the course of the proceeding. Repetitious or cumulative statements of an objection or the grounds for an objection are unnecessary and impermissible; and

(4) After the Department's examination of a witness, counsel for the witness may request that the witness be permitted to clarify any answers to correct any ambiguity, equivocation, or incompleteness in the witness's testimony. The decision to grant or deny this request is within the sole discretion of the presiding official.

§ 3800.60 Settlements.

(a) At any time during an investigation, the Department and the parties subject to an investigation may conduct settlement negotiations.

(b) When the Secretary or Secretary's designee deems it appropriate, the Department may enter into a settlement agreement.

CHAPTER XXIV—BOARD OF DIRECTORS OF
THE HOPE FOR HOMEOWNERS PROGRAM

<i>Part</i>		<i>Page</i>
4000	Board of Directors of the Hope for Homeowners Program	411
4001	Hope for Homeowners Program	411

PART 4000—BOARD OF DIRECTORS OF THE HOPE FOR HOMEOWNERS PROGRAM

Subpart A—Rules Regarding Access to Information Under the Freedom of Information Act

Sec.

4000.1 Purpose and scope.

4000.2 Freedom of Information Act.

AUTHORITY: 5 U.S.C. 552; 12 U.S.C. 1715z-22.

SOURCE: 74 FR 7813, Feb. 20, 2009, unless otherwise noted.

Subpart A—Rules Regarding Access to Information Under the Freedom of Information Act

§ 4000.1 Purpose and scope.

This subpart establishes the Board's procedures governing access to records of the Board under the Freedom of Information Act (5 U.S.C. 552).

§ 4000.2 Freedom of Information Act.

(a) *In general.* While the Board is not part of the Department of Housing and Urban Development ("HUD"), the Board follows the regulations promulgated by HUD at subparts A and B ("FOIA Disclosure Information") of part 15 ("Public access to HUD records under the Freedom of Information Act and testimony and production of information by HUD employees") of Title 24 ("Housing and Urban Development") of the Code of Federal Regulations ("CFR"), except as otherwise provided in this section. Any reference in 24 CFR 15.1 through 15.112 to "HUD" shall be construed to refer to the Board. In the event that the regulations at subparts A and B of part 15 of title 24 of the CFR subsequently are amended by HUD, the Board will follow those amended regulations. The following additional information is provided to implement 24 CFR 15.1 through 15.112 as such sections apply to the Board.

(b) *Requests for information.* All requests to the Board for access to records of the Board should be directed to the attention of the Board at the U.S. Department of Housing and Urban Development (HUD), Freedom of Information Act Office, 451 Seventh Street, SW., Room 10139, Washington, DC

20410-3000 (HUD Headquarters), where the Board maintains its principal place of business. Requestors should follow the directions for requesting records as provided in the regulations in 24 CFR part 15, subpart B. The public reading rooms for the Board are the reading rooms located at HUD Headquarters in Washington, DC. Due to security measures at HUD Headquarters, an advance appointment to review the public comments must be scheduled by calling the FOIA Office at 202-708-3054 (this is not a toll-free number).

(c) *Requests for records.* Initial determinations whether to grant requests for records of the Board will be made by the Secretary of the Board or the designee of such official. Requests for records by mail should be addressed to the same address as that provided in paragraph (a) of this section.

(d) *Administrative appeal of initial determination to deny records.* (1) Appellate determinations with respect to the records of the Board will be made by an official, designated by the Executive Director of the Board, who had no involvement in the initial determination of the request for records that is the subject of the appeal.

(2) Appellate determinations with respect to requests for expedited processing shall be made by the Secretary of the Board or the designee of such official.

(3) Appeals should be addressed to the address provided in paragraph (a) of this section.

(e) *Delivery of process.* Service of process will be received by Counselor to the Board or the designee of such official and shall be delivered to the address provided in paragraph (a) of this section to the attention of Counselor to the Board.

PART 4001—HOPE FOR HOMEOWNERS PROGRAM

Subpart A—HOPE for Homeowners Program—General Requirements

Sec.

4001.01 Purpose of program.

4001.03 Requirements and delegated authority.

4001.05 Approval of mortgages.

4001.07 Definitions.

§ 4001.01

Subpart B—Eligibility Requirements and Underwriting Procedures

- 4001.102 Cross-reference.
- 4001.104 Eligible mortgages.
- 4001.106 Eligible mortgagors.
- 4001.108 Eligible properties.
- 4001.110 Underwriting.
- 4001.112 Income verification.
- 4001.114 Appraisal.
- 4001.116 Representations and prohibitions.
- 4001.118 Equity sharing.
- 4001.120 Appreciation sharing or upfront payment.
- 4001.122 Fees and closing costs.

Subpart C—Rights and Obligations under the Contract of Insurance

- 4001.201 Cross-reference.
- 4001.203 Calculation of upfront and annual mortgage insurance premiums for Program mortgages.

Subpart D—Servicing responsibilities

- 4001.301 Cross-reference.
- 4001.303 Prohibition on subordinate liens during first five years.

Subpart E—Enforcement

MORTGAGOR FALSE INFORMATION

- 4001.401 Notice of false information from mortgagor-procedure.

APPRAISER INDEPENDENCE

- 4001.403 Prohibitions on interested parties in insured mortgage transaction.

MORTGAGEES

- 4001.405 Mortgagees.
- APPENDIX A TO PART 4001—CALCULATION OF UPFRONT PAYMENT OR FUTURE APPRECIATION PAYMENT.**

AUTHORITY: 12 U.S.C. 1701z-22.

SOURCE: 73 FR 58420, Oct. 6, 2008, unless otherwise noted.

Subpart A—HOPE for Homeowners Program—General Requirements

§ 4001.01 Purpose of program.

The HOPE for Homeowners Program is a temporary program authorized by section 257 of the National Housing Act, established within the Federal Housing Administration (FHA) of the Department of Housing and Urban Development (HUD) that offers homeowners and existing loan holders (or servicers acting on their behalf) FHA insurance on refinanced loans for dis-

tressed borrowers to support long-term sustainable homeownership by, among other things, allowing homeowners to avoid foreclosure. The HOPE for Homeowners Program is administered by HUD through FHA.

§ 4001.03 Requirements and delegated authority.

(a) *Core requirements.* This subpart establishes the core requirements for the HOPE for Homeowners Program that have been adopted by the Board of Directors (Board) for the HOPE for Homeowners Program (Program). In addition to the core requirements, codified in this subpart, the Board of Directors may adopt and issue additional requirements, standards and policies through non-codified regulations, including through order, FEDERAL REGISTER notice, or other statement, such as a mortgagee letter, to be issued and implemented by FHA.

(b) *Basic Program parameters.* (1) FHA is authorized to insure eligible refinanced mortgages under the Program commencing no earlier than October 1, 2008. The authority to insure additional mortgages under the Program expires September 30, 2011.

(2) Under this Program, an eligible mortgagor may obtain a refinancing of his or her existing mortgage(s) with a new mortgage loan insured by FHA, subject to conditions and restrictions specified in section 257 of the National Housing Act and requirements established by the Board.

(c) *Delegated authority.* HUD is statutorily charged with administering, through FHA, the Program. In carrying out the Program requirements established by the Board, FHA is directed to issue such interim guidance and mortgagee letters as FHA determines necessary or appropriate, within the parameters of the requirements, standards and policies adopted by the Board. In addition to FHA's statutory charge, the Board of Directors authorizes FHA to address unique or case-by-case situations as may be encountered by FHA in carrying out the Program, and to take such action as may be necessary to implement the Board's requirements. This delegated implementing authority

includes, but is not limited to, specifying application forms, mortgage application procedures, certifications or other assurances, and other information collection requirements, subject to such rules, standards and policies as the Board may adopt.

(d) *Other applicable requirements.* Except as may be otherwise provided by the Board, the provisions and requirements in the FHA regulations in 24 CFR part 203, which are generally applicable to all FHA-insured single family mortgage insurance programs, also apply with respect to the insurance of a refinanced eligible mortgage under the Program.

§ 4001.05 Approval of mortgagees.

(a) *Eligibility.* In order for a mortgage to be eligible for insurance under this part, the mortgagee originating the mortgage loan and seeking mortgage insurance under this part shall have been approved by the Secretary pursuant to 24 CFR part 202.

(b) *Mortgagee whose loan is to be refinanced.* A mortgagee holding or servicing an eligible mortgage to be refinanced and insured under section 257 of the National Housing Act is not required to be an approved mortgagee as required in paragraph (a) of this section, unless it seeks to be the originator of the refinanced mortgage to be insured by FHA.

§ 4001.07 Definitions.

As used in this part and in the Program, the following definitions apply.

Act means the National Housing Act (12 U.S.C. 1701 *et seq.*).

Allowable closing costs mean charges, fees and discounts that the mortgagee may collect from the mortgagor as provided in 24 CFR 203.27(a).

Board means the Board of Directors for the HOPE for Homeowners Program, which is comprised of the Secretary of HUD, the Secretary of the Treasury, the Chairman of the Board of Governors of the Federal Reserve System (Federal Reserve Board), and the Chairperson of the Board of Directors of the Federal Deposit Insurance Corporation or the designees of each such individual.

Capital improvements means a repair, renovation, or addition to a property

that significantly enhances the value of the property, but does not include expenses for interior decor, landscape maintenance, or normal maintenance or replacement expenses.

Contract of insurance means the agreement by which FHA provides mortgage insurance to a mortgagee.

Default and delinquency fees means late charges contained in a mortgage/security instrument for the late or non-receipt of payments from mortgagors after the date upon which payment is due, including charges imposed by the mortgagee for the return of payments on the mortgage due to non-sufficient funds.

Direct financial benefit, as used in section 257(e)(1)(A)(ii)(II) of the Act, consists of the greater of two factors:

(1) The amount of initial equity the mortgagor has in the property at the closing for the Program mortgage as determined under § 4001.118; and

(2) The total amount that the existing senior mortgage and all existing subordinate mortgages on the property have been written down.

Disposition means any transaction that results in whole or partial transfer of title of a property other than—

(1) A sale of the property; or

(2) Any transaction or transfer specified in 12 U.S.C. § 1701j-3(d)(1) through (8).

Eligible Mortgage means a mortgage as defined in § 4001.104.

Existing senior mortgage means an eligible mortgage that has superior priority and is being refinanced by a mortgage insured under section 257 of the Act.

Existing subordinate mortgage means a mortgage that is subordinate in priority to an eligible mortgage which is being refinanced by a mortgage insured under section 257 of the Act.

FHA means the Federal Housing Administration.

HOPE for Homeowners Program (or Program) means the program established under section 257 of the Act.

HUD means the Department of Housing and Urban Development.

Intentionally defaulted for purposes of section 257(e)(1)(A) of the Act means the mortgagor:

(1) Knowingly failed to make payment on the mortgage or debt;

§ 4001.102

(2) Had available funds at the time payment on the mortgage or debt was due that could pay the mortgage or debt without undue hardship; and

(3) The debt was not subject to a bona fide dispute.

Mortgage has the same meaning as provided in 24 CFR 203.17(a)(1).

Mortgagee has the same meaning as provided in 24 CFR 203.251(f).

Mortgagor has the same meaning as provided in 24 CFR 203.251(e).

Premium pricing means the price for the sale of a mortgage loan with an above market rate of interest.

Prepayment penalties mean such amounts as defined in 12 CFR 226.32(d)(6) of the Federal Reserve Board's Regulation Z (Truth in Lending).

Primary residence means the dwelling where the mortgagor maintains his or her permanent place of abode and typically spends the majority of the calendar year. A mortgagor can only have one primary residence.

Program mortgage means the mortgage into which the existing senior mortgage is refinanced.

Related party of a person means any of the following or another person acting on behalf of the person or any of the following—

(1) The person's father, mother, stepfather, stepmother, brother, sister, stepbrother, stepsister, son, daughter, stepson, stepdaughter, grandparent, grandson, granddaughter, father-in-law, mother-in-law, brother-in-law, sister-in-law, son-in-law, daughter-in-law, the spouse of any of the foregoing, and the person's spouse;

(2) Any entity of which 25 percent or more of any class of voting securities is owned, controlled or held in the aggregate by the person or the persons referred to in paragraph (1); and

(3) Any entity of which the person or any person referred to in paragraph (1) serves as a trustee, general partner, limited partner, managing member, or director.

Secretary means the Secretary of Housing and Urban Development.

Total monthly mortgage payment means the sum of:

(1) Principal and interest, as determined on a fully indexed and fully amortized basis; and

24 CFR Ch. XXIV (4–1–11 Edition)

(2) *Escrowed amounts.* (i) The monthly required amount collected by or on behalf of the mortgagee for real estate taxes, premiums for required hazard and mortgage insurance, homeowners' association dues, ground rent, special assessments, water and sewer charges and other similar charges required by the note or security instrument; or

(ii) For mortgages not subject to escrow deposits, $\frac{1}{12}$ of the estimated annual costs for items listed in paragraph (2)(i) of this definition.

[73 FR 58420, Oct. 6, 2008, as amended at 74 FR 621, Jan. 7, 2009]

Subpart B—Eligibility Requirements and Underwriting Procedures

§ 4001.102 Cross-reference.

(a) All of the provisions of 24 CFR part 203, subpart A, concerning eligibility requirements of mortgages covering one-family dwellings under section 203 of the National Housing Act (12 U.S.C. 1709) apply to mortgages on one-family dwellings to be insured under section 257 of the National Housing Act (12 U.S.C. 1701z-22), except the following provisions: 203.7 Commitment Process; 203.10 Informed consumer choice for prospective FHA mortgagors; 203.12 Mortgage insurance on proposed or new subdivisions; 203.14 Builder's warranty; 203.16 Certificate and contract regarding use of dwelling for transient or hotel purposes; 203.17(d) Maturity; 203.18 Maximum mortgage amounts; 203.18a Solar-energy system; 203.18b Increased mortgage amount; 203.18c One-time or up-front MIP excluded from limitations on maximum mortgage amounts; 203.18d Minimum principal loan amount; 203.19 Mortgagor's minimum investment; 203.20 Agreed interest rate; 203.29 Eligible mortgage in Alaska, Guam, Hawaii or the Virgin Islands; 203.32 Mortgage lien; 203.37a Sale of property; 203.42 Rental properties; 203.43 Eligibility of miscellaneous types of mortgages; 203.43a Eligibility of mortgages covering housing in certain neighborhoods; 203.43d Eligibility of mortgages in certain communities; 203.43e Eligibility of mortgages covering houses in

Board of Directors, Hope for Homeowners Program

§ 4001.110

federally impacted areas; 203.43g Eligibility of mortgages in certain communities; 203.43h Eligibility of mortgages on Indian land insured pursuant to section 248 of the National Housing Act; 203.43i Eligibility of mortgages on Hawaiian Home Lands insured pursuant to section 247 of the National Housing Act; 203.43j Eligibility of mortgages on Allegany Reservation of Seneca Nation Indians; 203.44 Eligibility of advances; 203.45 Eligibility of graduated payment mortgages; 203.47 Eligibility of growing equity mortgages; 203.49 Eligibility of adjustable rate mortgages; 203.50 Eligibility of rehabilitation loans; 203.51 Applicability; and 203.200-203.209 Insured Ten-Year Protection Plans (Plan).

(b) For the purposes of this subpart, all references in 24 CFR part 203, subpart A, to section 203 of the Act shall be construed to refer to section 257 of the Act. Any references in 24 CFR part 203, subpart A, to the "Mutual Mortgage Insurance Fund" shall be deemed to be to the Home Ownership Preservation Entity Fund, and any references to "the Commissioner" shall be deemed to be to the Board or the Commissioner (as the context may require).

(c) If there is any conflict in the application of any requirement of 24 CFR part 203, subpart A, to this part the provisions of this part shall control.

[73 FR 58420, Oct. 6, 2008, as amended at 74 FR 621, Jan. 7, 2009]

§ 4001.104 Eligible mortgages.

A mortgage eligible to be refinanced under section 257 of the Act must:

(a) Have been originated on or before January 1, 2008;

(b) Be secured by a property owned and occupied by the mortgagor as his or her primary residence, and be the only residence in which the mortgagor has any present ownership interest; and

(c) Meet such other requirements as the Board may adopt.

§ 4001.106 Eligible mortgagors.

A mortgagor shall be eligible to refinance his or her existing mortgages under section 257 of the Act only if:

(a)(1) The mortgagor had, on March 1, 2008, a total monthly mortgage payment (based on mortgages outstanding on March 1, 2008) of more than 31 per-

cent of the mortgagor's monthly gross income; or

(2) If the mortgagor's existing senior mortgage or existing subordinate mortgage, if any, is an adjustable-rate mortgage that by its terms resets after March 1, 2008, the mortgagor has a total monthly mortgage payment (based on mortgages outstanding on March 1, 2008) of more than 31 percent of the mortgagor's monthly gross income calculated as of the date the mortgagor first applies for the Program mortgage;

(b) The mortgagor does not have an ownership interest in any other residential property;

(c) The mortgagor has not been convicted of fraud under federal or state law in the past 10 years;

(d) The mortgagor certifies that the mortgagor has not intentionally defaulted on any mortgage or debt and has not knowingly, or willfully and with actual knowledge, furnished material information known to be false for purposes of obtaining any Program mortgage; and

(e) The mortgagor meets such other requirements as the Board may adopt.

[74 FR 621, Jan. 7, 2009]

§ 4001.108 Eligible properties.

(a) A mortgage may be insured under the Program only if the property that is to be the security for the mortgage is a 1-to-4 unit residence.

(b) The following property types are eligible to secure a mortgage insured under the Program:

(1) Detached and semi-detached dwellings;

(2) A condominium unit;

(3) A cooperative unit; or

(4) A manufactured home that is permanently affixed to realty and is treated as realty under applicable state law except state taxation law.

[73 FR 58420, Oct. 6, 2008, as amended at 74 FR 621, Jan. 7, 2009]

§ 4001.110 Underwriting.

A mortgage may be insured under the Program only if the following conditions are met:

(a) *Loan-to-value and income thresholds.* The loan-to-value (LTV), payment-to-income, and debt-to-income

§ 4001.112

ratios of the Program mortgage do not exceed the thresholds set forth in either paragraph (a)(1) or (a)(2) of this section.

(1) *Program mortgage with LTV ratio of 90 percent or less.* (i) The initial principal balance of the Program mortgage as a percentage of the current appraised value of the property does not exceed 90 percent;

(ii) The total monthly mortgage payment of the mortgagor under the Program mortgage does not exceed 38 percent of the mortgagor's monthly gross income; and

(iii) The sum of the total monthly mortgage payment under the Program mortgage and all monthly recurring expenses of the mortgagor does not exceed 50 percent of the mortgagor's monthly gross income.

(2) *Program mortgage with up to 96.5 percent LTV.* (i) The initial principal balance of the Program mortgage as a percentage of the current appraised value of the property does not exceed 96.5 percent;

(ii) The total monthly mortgage payment of the mortgagor under the Program mortgage does not exceed 31 percent of the mortgagor's monthly gross income; and

(iii) The sum of the total monthly mortgage payment under the Program mortgage and all monthly recurring expenses of the mortgagor does not exceed 43 percent of the mortgagor's monthly gross income.

(b) *Past credit performance.* The mortgagor must have made at least six full payments on the existing senior mortgage being refinanced under the Program.

(c) The Program mortgage shall have a maturity of not less than 30 years and not more than 40 years from the date of origination.

(d) *Non-occupant co-borrowers.* A mortgage loan may be insured by the FHA under the Program, even if one of the mortgagors on the loan (*i.e.*, a co-signer) does not reside at the residence securing the loan, provided that the non-resident mortgagor relinquishes all interests in the property that is to be security for the mortgage before an application is submitted for FHA insurance under the Program.

24 CFR Ch. XXIV (4-1-11 Edition)

(e) *Amount of new mortgage payment.* The mortgagor's total monthly payment on the mortgage to be insured under the Program must not be greater than the mortgagor's aggregate total monthly mortgage payment under the mortgagor's existing senior mortgage and all existing subordinate mortgages.

(f) *Limit on origination fees.* Mortgagees may charge and collect from mortgagors allowable closing costs.

[73 FR 58420, Oct. 6, 2008, as amended at 74 FR 621, Jan. 7, 2009]

§ 4001.112 Income verification.

The mortgagee shall use FHA's procedures to verify the mortgagor's income and shall comply with the following additional requirements:

(a) The mortgagee shall document and verify the income of the mortgagor by obtaining a transcript of the borrower's Federal income tax returns or a copy of the borrower's Federal income tax returns obtained directly from the Internal Revenue Service for the most recent two years; and

(b) The mortgagee shall document and verify the mortgagor's income in any case in which the mortgagor has not filed a Federal income tax return.

§ 4001.114 Appraisal.

(a) The property shall be appraised by an appraiser on the FHA Appraiser Roster.

(b) An appraisal of a property to be security for a Program mortgage shall be conducted in accordance with Uniform Standards of Professional Appraisal Practice (USPAP) but dated no more than 90 days from the date on which the mortgage transaction is closed, except as otherwise provided by the Board.

(c) The mortgagee must inform the appraiser that copies of the appraisal may be shared with holders and servicers of existing subordinate mortgages.

§ 4001.116 Representations and prohibitions.

(a) *Underwriting and appraisal standards.* In order for the Program mortgage to be eligible for insurance under the Program, the underwriter and the mortgagee must provide certifications, in a format approved by the FHA, that

the mortgage is in compliance with the underwriting and the appraisal standards set forth in this part, and that it meets all requirements applicable to the Program. FHA may require additional certifications by the mortgagee to ensure compliance with such additional standards as the FHA deems necessary given the specific mortgage transaction presented.

(b) *Mortgagor's liability for repayment.*

(1) The mortgagor shall provide a certification to FHA that the mortgagor has not:

(i) Intentionally defaulted on the mortgagor's existing mortgage(s), or any other debt; or

(ii) Knowingly or willfully and with actual knowledge furnished material information known to be false for the purpose of obtaining the mortgagor's existing mortgage(s).

(2) The mortgagor shall provide any other certifications that FHA may otherwise require.

(3) A mortgagor obligated under a Program mortgage shall agree in writing, on a form approved by the Board, to be liable to pay to FHA any Direct Financial Benefit achieved from the reduction of indebtedness on the existing senior and subordinate mortgages that are being refinanced under the Program if he or she makes a false statement or other misrepresentation in the certifications and documentation required for Program eligibility, including but not limited to the certifications required under section 257(e)(1)(A)(i) of the Act.

(c) *Mortgagee in violation of Program requirements.* (1) If the mortgagee holds a Program mortgage that it originated and/or underwrote, and FHA finds that the mortgagee violated the Program requirements, FHA is prohibited from paying FHA insurance benefits to that mortgagee.

(2) If the mortgagee no longer holds the Program mortgage that it originated and/or underwrote, FHA will pay the insurance claim to the mortgagee presently holding the Program mortgage (if all other requirements of the contract for mortgage insurance are met and the present holder did not participate in the violation of Program requirements) and shall seek indem-

nification from the non-holding mortgagee.

(d) *FHA insurance.* A mortgage is eligible for insurance if the mortgagee submits a complete case binder within such time period as the Board prescribes. The binder shall include evidence acceptable to the Board that the mortgage is current.

(e) *Mortgagor failure to make first mortgage payment.* FHA shall not pay a mortgage insurance claim to any mortgagee if the first total monthly mortgage payment is not made within 120 days from the date of closing of the mortgage. The mortgagee shall not, directly or indirectly, make all or a part of the first total monthly mortgage payment on behalf of the mortgagor. The mortgagee is prohibited from escrowing funds at closing for all or part of the first total monthly mortgage payment.

[73 FR 58420, Oct. 6, 2008, as amended at 74 FR 621, Jan. 7, 2009]

§ 4001.118 Equity sharing.

(a) *Initial Equity.* For purposes of section 257(k)(1) of the Act, the initial equity created as a direct result of the origination of a Program mortgage on a property, as calculated by the Program mortgage lender, shall equal:

(1) The lesser of—

(i) The appraised value of the property that was used at the time of origination of the Program mortgage to underwrite the mortgage and to determine compliance with the maximum loan-to-value ratio at origination established by section 257(e)(2)(B) of the Act; or

(ii) The outstanding amount due under all existing senior mortgages, existing subordinate mortgages, and non-mortgage liens on the property; less

(2) The original principal amount of the Program mortgage on the property.

(b) *FHA's interest.* Upon the sale or disposition of a property or Program mortgage refinancing, FHA shall calculate and be entitled to receive the portion of the initial equity (as defined by paragraph (a) of this section) set forth in section 257(k)(1) of the Act,

§ 4001.120

subject to such standards and policies as the Board may establish.

[73 FR 58420, Oct. 6, 2008, as amended at 74 FR 622, Jan. 7, 2009]

§ 4001.120 Appreciation sharing or up-front payment.

(a) *Calculation of appreciation.* For purposes of section 257(k)(2) of the Act, the amount of the appreciation in value of a property securing a Program mortgage that occurs between the date the mortgage was insured under section 257 of the Act and the date of any subsequent sale or disposition of the property shall be equal to the following, as such amounts of appreciation may be established to the satisfaction of FHA:

(1) In the case of—

(i) A sale of the property to one or more persons none of which is a related party of the mortgagor, the gross proceeds from the sale of the property; or

(ii) A disposition of the property or the sale of the property to a related party of the mortgagor, the current appraised value of the property at the time of the disposition or sale; less

(2) The amount of closing costs, as adopted by the Board, incurred by the mortgagor(s) in connection with such sale or disposition, if any; less

(3) Seventy-five percent, as may be modified by the Board, of the actual expenditures for Capital Improvements made by the mortgagor(s) after the date of origination of the Program mortgage; and less

(4) The appraised value of the property that was used at the time of origination of the Program mortgage to underwrite that mortgage and determine compliance with the maximum loan-to-value ratio at origination established by section 257(e)(2)(B) of the Act.

(b) *HUD's interest in appreciation.* Upon sale or disposition of a property securing a Program mortgage, FHA shall be entitled to receive an amount equal to 50 percent of the appreciation in value of the property calculated in accordance with paragraph (a) of this section.

(c) *Eligibility of subordinate mortgage holders to receive a portion of appreciation in value.* The persons or entities that hold, on the date of origination of a Program mortgage, an existing sub-

ordinate mortgage on the property shall be eligible to receive a portion of FHA's interest in the appreciation in value of the property, as determined in accordance with the provisions of this section and such additional standards and policies that the Board may establish, if:

(1) The existing subordinate mortgage was originated on or before January 1, 2008;

(2) The amount of the unpaid principal and interest on such existing subordinate mortgage, as of the first day of the month in which the mortgagor made application for the Program mortgage, is at least \$2,500; and

(3) Each person holding such existing subordinate mortgage agrees, in connection with the origination of the Program mortgage, to fully release:

(i) The mortgagor(s) from any indebtedness under the existing subordinate mortgage; and

(ii) The holder's mortgage lien on the property.

(d) *Shared appreciation interest of subordinate mortgage holders.*

(1) *In general.* The eligible holder(s) of an existing subordinate mortgage on a property securing a Program mortgage shall be eligible to receive, subject to paragraph (c)(3) of this section, an interest in FHA's interest in the appreciation in the value of such property up to the amount set forth in the Appendix to this part.

(2) *Form.* The interest of an eligible holder of an existing subordinate mortgage under paragraph (d) of this section is evidenced in a shared appreciation certificate or other documentation to be issued by, or on behalf of, HUD.

(3) *Multiple subordinate liens.* If there is more than one eligible existing subordinate mortgage on a property securing a Program mortgage, the interests of such eligible existing subordinate mortgages under paragraph (d)(1) of this section shall have priority among each other in the same order of priority that existed among the existing subordinate mortgages on the date of origination of the Program mortgage.

(4) *Distribution of appreciation interest to subordinate mortgage holders.* Upon the sale or disposition of a property securing a Program mortgage other than

Board of Directors, Hope for Homeowners Program

§ 4001.201

sale or disposition related to a default, any proceeds due to FHA as a result of the appreciation in value of the property (as calculated in accordance with paragraph (a) of this section) shall be distributed:

(i) First to the holders of any shared appreciation certificate or other documentation issued by HUD with respect to the property, if any, in accordance with paragraphs (d)(1), (d)(2), and (d)(3) of this section; and

(ii) The remaining amounts, if any, will be retained by FHA.

(e) *Election to receive upfront payment in lieu of a share of appreciation.* Upon meeting the requirements of paragraph (c) of this section, the eligible holder(s) of an existing subordinate mortgage on a property securing a Program mortgage may elect to receive, contemporaneously with the origination of the Program mortgage, a payment from FHA in an aggregate amount determined in accordance with the formula provided in Appendix A to this part in lieu of any right to receive a portion of FHA's 50 percent interest in the future appreciation in the appraised value of such property under paragraph (c) of this section.

[73 FR 58420, Oct. 6, 2008, as amended at 74 FR 622, Jan. 7, 2009]

§ 4001.122 Fees and closing costs.

(a) The holder or servicer of the existing senior and subordinate mortgages shall either forgive or waive all prepayment penalties and delinquency and default fees.

(b) Allowable closing costs incurred in connection with the refinancing and insurance of a mortgage under the Program can be paid from the following sources:

(1) The mortgagor's assets;

(2) The mortgagee holding or servicing the existing senior and subordinate mortgage or the mortgagee originating the Program mortgage;

(3) Premium pricing by the mortgagee providing the Program mortgage;

(4) Financed as part of the Program mortgage provided that the mortgage amount is adjusted accordingly, and the loan-to-value ratio does not exceed 90 percent (including the up-front premium required under § 4001.203(a)(1));

(5) A Federal, state, county or parish, or municipal program; or

(6) Such other sources as the Board may permit.

Subpart C—Rights and Obligations Under the Contract of Insurance

§ 4001.201 Cross-reference.

(a) All of the provisions of 24 CFR part 203, subpart B, covering mortgages insured under section 203 of the Act shall apply to mortgages insured under section 257 of the Act, *except the following sections:* 203.256 Insurance of open-end advances; 203.259a Scope; 203.260 Amount of insurance premium; 203.261 Calculation of periodic MIP (periodic MIP); 203.270 Open-end insurance charges; 203.280 One-time of Up-front MIP; 203.281 Calculation of one-time MIP; 203.283 Refund of one-time MIP; 203.284 Calculation of up-front and annual MIP on or after July 1, 1991; 203.285 Fifteen year mortgages: calculation of up-front and annual MIP on or after December 26, 1992; 203.415–203.417 Certificate of Claim; 203.420–203.427 Mutual Mortgage Insurance Fund and Distributive Shares; 203.436 Claim procedures—graduated payment mortgages; 203.438 Mortgages on Indian land insured pursuant to section 248 of the National Housing Act; 203.439 Mortgages on Hawaiian home lands insured pursuant to section 247 of the National Housing Act; 203.439a Mortgages on property in Allegheny Reservation of Seneca Nation of Indians authorized by section 203(q) of the National Housing Act; and 203.440–203.495 Rehabilitation Loans.

(b) For the purposes of this subpart, all references in 24 CFR part 203, subpart B, to section 203 of the Act shall be construed to refer to section 257 of the Act. Any references in 24 CFR part 203, subpart B, to the “Mutual Mortgage Insurance Fund” shall be deemed to be to the Home Ownership Preservation Entity Fund, and any references to “the Commissioner” shall be deemed to be to the Board or the Commissioner (as the context may require).

(c) If there is any conflict in the application of any requirement of 24 CFR part 203, subpart B, to this part 4001, the provisions of part 4001 shall control.

§ 4001.203

§ 4001.203 Calculation of upfront and annual mortgage insurance premiums for Program mortgages.

(a) *Applicable premiums.* Any mortgage presented for endorsement under section 257 on or after October 1, 2008, and prior to September 30, 2011, shall be subject to the following requirements:

(1) *Upfront premium.* FHA shall establish and collect a single premium payment equal to 3 percent of the amount of the original insured principal obligation of the Program mortgage.

(2) *Annual premium.* In addition to the premium under paragraph (a)(1) of this section, FHA shall establish and collect an annual premium payment in an amount equal to 1.5 percent of the amount of the remaining insured principal balance of the Program mortgage.

(b) *Proceeds for payment of the upfront premium.* The up-front premium shall be paid with proceeds from the Program mortgage through a reduction of the amount of indebtedness that existed on the eligible mortgage prior to its being refinanced.

Subpart D—Servicing Responsibilities

§ 4001.301 Cross-reference.

(a) All of the provisions of 24 CFR part 203, subpart C, covering mortgages insured under section 203 of the Act shall apply to mortgages insured under section 257 of the Act, *except as follows*: 203.664 Processing defaulted mortgages on property located on Indian land; 203.665 Processing defaulted mortgages on property located on Hawaiian home lands; 203.666 Processing defaulted mortgages on property in Allegany Reservation of Seneca Nation of Indians; and 203-670-203.681 Occupied Conveyance.

(b) For the purposes of this subpart, all references in 24 CFR part 203, subpart C, to section 203 of the Act shall be construed to refer to section 257 of the Act. Any references in 24 CFR part 203, subpart C, to the “Mutual Mortgage Insurance Fund” shall be deemed to be to the Home Ownership Preservation Entity Fund, and any references to “the Commissioner” shall be

24 CFR Ch. XXIV (4-1-11 Edition)

deemed to be to the Board or the Commissioner (as the context may require).

(c) If there is any conflict in the application of any requirement of 24 CFR part 203, subpart C, to this part 4001, the provisions of part 4001 shall control.

§ 4001.303 Prohibition on subordinate liens during first five years.

(a) *Prohibition on subordinate liens during first five years.* Except as provided in paragraph (b) of this section, a mortgagor shall not, during the first 5 years of the term of the mortgagor’s Program mortgage, incur any debt, take any action, or fail to take any action that would have the direct result of causing a lien to be placed on the property securing the Program mortgage if such lien would be subordinate to the Program mortgage.

(b) *Property preservation exception.* Paragraph (a) of this section shall not prevent a mortgagor on the Program mortgage from incurring new mortgage debt secured by a lien on the property securing the Program mortgage that is subordinate to the Program mortgage if:

(1) The proceeds of the new mortgage debt are necessary to ensure the maintenance of property standards, including health and safety standards;

(2) Repair or remediation of the condition would preserve or increase the property’s value;

(3) The cost of the proposed repair or remediation is reasonable for the geographic market area;

(4) The results of the repair or remediation are not primarily cosmetic;

(5) The repair or remediation does not represent routine maintenance;

(6) The new mortgage debt is closed-end credit, as defined in § 226.2 of the Federal Reserve Board’s Regulation Z (12 CFR 226.2); and

(7) The sum of the unpaid principal balance and accrued and unpaid interest on the Program mortgage and the original principal balance of the new mortgage debt:

(i) Does not exceed 95 percent of the estimated appraised value of the property securing the Program mortgage after completion of the proposed repair or remediation; and

(ii) Is less than:

(A) The estimated appraised value of the property securing the Program mortgage after completion of the proposed repair or remediation; less

(B) FHA's proportionate share of the initial equity created upon origination of the Program mortgage as determined pursuant to the schedule set forth in section 257(k)(1) of the Act as if a sale of the property had occurred on the date of origination of the new mortgage debt.

Subpart E—Enforcement

MORTGAGOR FALSE INFORMATION

§ 4001.401 Notice of false information from mortgagor-procedure.

(a) If FHA finds that the mortgagor has made a false certification or provided false information via any means, including but not limited to false documentation, FHA shall inform the mortgagor, in writing or any other acceptable format, of such fact.

(b) The notice shall be sent to the mortgagor's last known address by both certified and ordinary mail. The notice shall state with specificity the misrepresentation or false statement made by the mortgagor. The notice shall include a request for repayment of the Direct Financial Benefit that the mortgagor is deemed to have received, as determined by FHA, by the refinancing of the eligible mortgage and subordinate mortgages. This does not preclude HUD or the United States from bringing any other action that they may be authorized to bring.

(c) The mortgagor may request a hearing before a Hearing Officer. The hearing will be conducted in accordance with the provisions of 24 CFR part 26, subpart A, except as modified by this section. Requests for a hearing must be made within 45 days from the date of the false information notice.

APPRAISER INDEPENDENCE

§ 4001.403 Prohibitions on interested parties in insured mortgage transaction.

(a) A mortgage lender, mortgage broker, mortgage banker, real estate broker, appraisal management company or employee thereof, and any person with an interest in a real estate

transaction involving an appraisal conducted as part of the process for insuring a mortgage under section 257 of the Act shall not improperly influence or attempt to improperly influence through any means, including but not limited to coercion, extortion, collusion, compensation, instruction, inducement, intimidation, nonpayment for services rendered, or bribery, the development, reporting, result or review of a real estate appraisal sought in connection with the origination, processing and closing of the mortgage for insurance.

(b) HUD may, pursuant to its authority under section 536(a) of the Act, bring an action to impose a civil money penalty for a violation of paragraph (a) of this section.

(c) The authority to bring a civil money penalty under this section shall not preclude HUD from bringing any other action that HUD may be authorized to bring for a violation of paragraph (a) of this section.

MORTGAGEES

§ 4001.405 Mortgagees.

(a) FHA is authorized by the Board to engage in monitoring activities to ensure mortgagee compliance with the requirements of this Program. The Mortgagee Review Board at HUD is authorized by the Board to impose sanctions and civil money penalties against mortgagees that violate program requirements under this part. The authority of the Mortgagee Review Board to impose sanctions and civil penalties shall not preclude HUD from bringing any other action that HUD may be authorized to bring.

(b) Nonpayment of mortgage insurance claims for reasons established in § 4001.16 shall not preclude the Mortgagee Review Board or HUD from bringing any action against the mortgagee that the Mortgagee Review Board or HUD are authorized to bring.

(c) The mortgagee may request a hearing before a Hearing Officer. The hearing will be conducted in accordance with the provisions of 24 CFR part 26, subpart A, except as modified by this section. Requests for a hearing must be made within 45 days from the date of the false information notice.

APPENDIX A TO PART 4001—CALCULATION OF UPFRONT PAYMENT OR FUTURE APPRECIATION PAYMENT

Subordinate mortgage lien holder's cumulative combined loan-to-value ratio	Upfront payment option Percent of unpaid principal and interest that lien holder is eligible to receive # (percent)	Future appreciation option* Percent of unpaid principal and interest that lien holder is eligible to receive # (percent)
>135%	3	9
≤135%	4	12

* A payment to a subordinate mortgage lien holder will depend on actual appreciation of the property as determined in accordance with 24 CFR 4001.120. Payment will be made according to the subordinate lien holder's position of priority in relation to the property at the time the Program mortgage is originated.

Payment will be based upon principal and interest as of the first day of the month in which the borrower made application for the Program mortgage, calculated at the pre-default contract rate of interest.

[74 FR 622, Jan. 7, 2009]

CHAPTER XXV—NEIGHBORHOOD REINVESTMENT CORPORATION

<i>Part</i>		<i>Page</i>
4100	Organization and channeling of functions	425

PART 4100—ORGANIZATION AND CHANNELING OF FUNCTIONS

Sec.

4100.1 Functions and activities.

4100.2 General organization.

4100.3 Field activities.

4100.4 Inquiries.

AUTHORITY: Title VI, Pub. L. 95-557, 92 Stat. 2115 (42 U.S.C. 8101 *et seq.*); as amended by sec. 315, Pub. L. 96-399, 94 Stat. 1645; sec. 710, Pub. L. 97-320, 96 Stat. 1544; and sec. 520, Pub. L. 100-242, 101 Stat. 1815.

SOURCE: 49 FR 12700, Mar. 30, 1984, unless otherwise noted.

§ 4100.1 Functions and activities.

(a) *General statement.* The Neighborhood Reinvestment Corporation (referred to in this part as *the Corporation*) was established by Congress in the Neighborhood Reinvestment Corporation Act (title VI of the Housing and Community Development Amendments of 1978, Pub. L. 95-557, October 31, 1978). The Corporation is not a department, agency, or instrumentality of the Federal Government.

(b) The Corporation is authorized to receive and expend Federal appropriations and other public and private revenues to conduct a variety of programs designed primarily to revitalize older urban neighborhoods by mobilizing public, private, and community resources at the neighborhood level. These programs include:

(1) *Neighborhood Housing Services.* The major effort of the Corporation is to assist local communities in the development, expansion and provision of technical services to local Neighborhood Housing Services (NHS) programs. NHS programs are based upon partnerships of community residents, and representatives of local governments and financial institutions. Each local program is administered by an autonomous, private, non-profit corporation, and conducts a comprehensive revitalization effort in locally selected neighborhoods. Services to neighborhood residents include rehabilitation counseling, construction assistance, financial counseling, loan referrals and loans at flexible rates and terms to homeowners who do not meet private lending criteria. Programs and strategies to remove blighting influ-

ences, obtain improved public services and amenities, and improve the neighborhood's image and the functioning of its real estate market are also undertaken. To insure the continuing effectiveness of NHS programs, the Corporation provides grants, training, information and technical services to NHS programs.'

(2) *Mutual Housing Associations.* The Corporation also supports the organizational development of, and provides technical assistance to, Mutual Housing Associations. Mutual Housing Associations are private, nonprofit organizations which own, manage and continually develop affordable housing. Mutual Housing residents are members of the Association which owns and manages their buildings; thus they enjoy the security of long-term housing tenure. Mutual Housing developments are capitalized through up-front grants and mortgages in a combination that ensures permanent affordability to low- and moderate-income families. Monthly housing charges to residents are kept at affordable levels on a continuing basis. A key element of Mutual Housing is the Association's commitment to use all resources in excess of operating and maintenance costs for the production of additional units. A Mutual Housing Association's board of directors includes current member-residents, potential residents, and representatives from the community, local government and business. Residents and community members make up the majority on the board. A highly qualified professional staff, employed by the Mutual Housing Association, carries out the day-to-day activities of the organization. In addition to creating new affordable housing opportunities, Mutual Housing Associations offer a creative alternative for subsidized rental housing developments whose subsidies are scheduled to expire.

(3) *Neighborhood preservation projects.* The Corporation identifies, monitors, evaluates and supports through demonstration grants and technical assistance other promising neighborhood preservation strategies based on local, public-private partnerships.

(4) *Programmatic supplements.* Proven, replicable programmatic tools are offered as broadly as resources permit. Often, these selected strategies are supported by Neighborhood Reinvestment grants. The Corporation's major programmatic supplements include the following:

(i) *Neighborhood economic development and commercial revitalization strategies.* The Corporation's neighborhood economic development and commercial revitalization strategies offer NHSs a variety of tools designed to stabilize and enhance the economic base of NHS neighborhoods. They complement NHSs' revitalization mission by focusing the energies and resources of the partnership on the economic issues underlying neighborhood decline. Neighborhood economic development and commercial revitalization assures a viable neighborhood economy by strengthening small businesses and improving the physical environment of the area, thus providing additional goods, services, and employment opportunities for the community.

(ii) *Housing Development Strategies.* The Corporation's Housing Development Strategies program addresses the shortage of affordable, quality housing available to low to moderate income families in NHS neighborhoods, as well as the blighting effect of vacant lots and substandard properties. Home ownership opportunities are created through the planning and implementation of a variety of housing mechanisms by the NHS, which are intended to reverse negative real estate market trends, enhance new residential growth, and create renewed neighborhood pride. The mechanisms being used to achieve these goals include the following.

(A) The Owner Built Housing program is a supervised housing construction process that helps moderate-income homeowners to collectively build their own homes. The NHS provides technical assistance while private lenders and public bodies providing financing.

(B) The Owner Rehab Housing program assists low to moderate income families in collectively rehabilitating existing blighted and vacant structures.

(C) The Infill Housing program provides a mechanism for assisting NHSs in building new units on vacant land to meet the needs of prospective lower income homeowners.

(D) The Urban Subdivisions program focuses on providing low cost, new housing for low-to-moderate income families on tracts of land suitable for the construction of 20 or more units.

(iii) *Problem properties strategies.* This program assists NHSs in addressing specific problem areas beyond the scope of basic NHS services and typical financial resources. Through the implementation of various problem properties strategies, NHS programs are able to assist tenants to purchase, improve the physical condition of target blocks, eliminate vacant neighborhood eyesores, develop housing and service facilities for special populations, and stimulate private reinvestment and new conventional mortgages in the NHS community.

(5) *Apartment Improvement Program.* The goal of the Apartment Improvement Program is to provide an effective, economical means of revitalizing and preserving neighborhoods with multi-family housing for the benefit of the current residents. The program is based upon a partnership of tenants and community representatives, property owners and managers, financial institutions and local government. The program assists in the development of an individually tailored improvement plan of activities from which each building may benefit, including tenant participation, tax assessment reviews, and increased investment or restructured mortgages to improve the economic viability of the buildings and to finance improvements.

(6) *Neighborhood Housing Services of America.* The Corporation also supports Neighborhood Housing Services of America (NHSA), an independent, private, non-profit corporation which provides a variety of services to local NHS programs, including a secondary market for NHS revolving loan fund loans, and the strengthening of private sector resources available to the network of local NHSs.

[49 FR 12700, Mar. 30, 1984, as amended at 54 FR 13061, Mar. 30, 1989]

Neighborhood Reinvestment Corporation

§ 4100.3

§ 4100.2 General organization.

(a) *The Board of Directors.* (1) The Corporation is under the direction of a Board of Directors composed of six members: the Chairman of the Federal Home Loan Bank Board or a member of the Federal Home Loan Bank Board designated by the Chairman; the Secretary of Housing and Urban Development; the Chairman of the Board of Governors of the Federal Reserve System, or a member of the Board of Governors of the Federal Reserve System designated by the Chairman; the Chairman of the Federal Deposit Insurance Corporation or the appointive member of the Board of Directors of the Federal Deposit Insurance Corporation if so designated by the Chairman; the Comptroller of the Currency; and the Chairman of the National Credit Union Administration, or a member of the Board of the National Credit Union Administration designated by the Chairman. Members of the Board serve without additional compensation. The Board elects from among its members a Chairman and Vice-Chairman. The Bylaws of the Corporation provide for the creation of an Audit Committee, and such other committees as the Board may from time to time establish.

(2) The Board holds an Annual Meeting each year during the month of May (or as the Bylaws or the Board may specify). The Board also holds regular meetings at least quarterly and special meetings as required. The meetings of the Board are conducted in accordance with provisions of the Neighborhood Reinvestment Corporation Act, the Government in the Sunshine Act (5 U.S.C. 552b), the Corporation's Bylaws, and when not inconsistent with the foregoing, with Robert's Rules of Order. Every portion of every meeting of the Board is open to public observation except as provided by the Government in the Sunshine Act. Interested members of the public may attend such meetings, but may not participate therein unless invited or permitted to do so by the Board.

(3) The Secretary of the Corporation, in consultation with the Corporation's General Counsel, is responsible for taking such steps as are required to ensure the Corporation's compliance with the Government in the Sunshine Act, as

that Act may be amended from time to time. Consistent with this responsibility, the Secretary of the Corporation provides to the Communications Department at the principal office of the Corporation such records as the Act requires to be made available to the public for access during regular office hours on regular business days.

(b) *The Officers.* (1) The officers of the Corporation are the Executive Director, the Deputy Executive Director, the Secretary, the Treasurer, and such other officer positions as the Board may, in consultation with the Executive Director, create. The Board elects the officers of the Corporation annually.

(2) The Neighborhood Reinvestment Corporation Act provides that the Executive Director shall serve as the chief executive officer of the Corporation. Consistent with that authority, the Corporation's Bylaws provide that the Executive Director shall have the responsibility and authority for the day-to-day administration of the affairs of the Corporation under the general supervision of the Board. The Board periodically reviews the activities of the Executive Director and, from time to time, provides guidance and policy direction to the Executive Director in the exercise of his or her authority.

(3) The responsibilities and authorities of the other officers of the Corporation are set forth in the Corporation's Bylaws, resolutions and policies adopted by the Board, duties and authorities delegated to each officer, other statutes and this statement. (See, for example, the Government in the Sunshine Act and paragraph (a)(3) of this section for specific duties of the Secretary and General Counsel.)

(c) *Principal office.* The Corporation maintains its principal office in the District of Columbia. Currently, the principal office is maintained at 1325 G Street NW., Suite 800, Washington, DC 20005.

[49 FR 12700, Mar. 30, 1984, as amended at 54 FR 13062, Mar. 30, 1989]

§ 4100.3 Field activities.

The Corporation conducts its field activities from district and field offices around the country. District offices

§ 4100.4

provide coordination of field activities in support of local programs within the geographic limits of each district. Field offices within each district provide assistance in the development and support of local programs. A current directory of all district and field offices can be obtained upon request from the Communications Department, Neighborhood Reinvestment Corporation, 1325 G Street NW., Suite 800, Washington, DC 20005.

[49 FR 12700, Mar. 30, 1984, as amended at 54 FR 13061, Mar. 30, 1989]

§ 4100.4 Inquiries.

(a) *General.* All requests for information, forms, and records should be addressed to: Communications Department, Neighborhood Reinvestment Corporation, 1325 G Street NW., Suite 800, Washington, DC 20005.

(b) *Applications.* Applications for the Corporation's assistance in the development of NHS programs and complementary programs and strategies, or the support of other promising neighborhood strategies are accepted on an ongoing basis. Local governmental or nonprofit entities should submit completed applications (forms are available upon request), including supportive materials, to the Corporation at the address stated in paragraph (a) of this section. The Corporation reviews applications to determine their readiness for development or support. Promising applications are selected for field reviews. Subject to the availability of the Corporation's resources, the Corporation may enter into agreements with top ranking applicants to provide financial and technical assistance in the development or support of selected programs. The application form contains a list of the criteria used for determining the readiness and promise of applications.

(c) *Records.* (1) The Corporation maintains such records and information for public inspection and copying as are required by the Freedom of Information Act (5 U.S.C. 552), as that Act may be amended from time to time. Records are available for public inspection and copying during regular business hours on regular business days at the address stated in paragraph (a) of this section. Requests for records should be sub-

24 CFR Ch. XXV (4-1-11 Edition)

mitted in writing and state the full name and address of the person requesting the records and a description of the records or other information sought that is reasonably sufficient to permit their identification without undue difficulty. A request should be submitted sufficiently in advance of the date inspection or copying is desired, preferably by mail.

(2) Although the Corporation finds that the publication of indexes of statements of policy and interpretations or administrative staff manuals and instructions would be unnecessary and impracticable, such information will be made available upon request.

(d) *Fees for providing copies for records.* Fees shall be assessed pursuant to the Freedom of Information Act (5 U.S.C. 552) in order to recover the full allowable direct costs of providing copies of records. For purposes of this section, the term *direct costs* means those expenditures which the Corporation actually incurs in searching for and duplicating (and in the case of commercial use requesters, reviewing) documents to respond to a Freedom of Information Act ("FOIA") request. Direct costs include, for example, the salaries of the employees performing the work (the basic rate of pay plus 16 percent of that rate to cover benefits) and the cost of operating duplicating equipment. The term *search* includes all time spent looking for material that is responsive to a request, including page-by-page or line-by-line identification of material within documents. Searches may be done manually or by computer using existing programming. The term *duplication* refers to the process of making a copy of a document necessary to respond to a FOIA request. Such copies can take the form of paper copy, microfilm, audiovisual materials, or machine readable documentation (e.g., magnetic tape or disk), among others. The term *review* refers to the process of examining documents located in response to a commercial use request to determine whether any portion of any document is permitted to be withheld. It also includes processing any documents for disclosure, e.g., doing all that is necessary to exist them and otherwise prepare them for release. Review does not include time spent resolving general

Neighborhood Reinvestment Corporation

§ 4100.4

legal or policy issues regarding the application of exemptions. A schedule based on these principles is set forth in paragraph (d)(9) of this section.

(1) *Categories of requesters.* Fees will be assessed according to the category of the requester. There are four categories:

(i) *Commercial use requesters.* For purposes of this section, the term *commercial use request* refers to a request from or on behalf of one who seeks information for a use or purpose that furthers the commercial, trade, or profit interests of the requester or the person on whose behalf the request is made. In determining whether a requester properly belongs in this category, the Corporation will look to the use to which the requester will put the documents requested. If the use is not clear from the request itself, or if there is reasonable cause to doubt the requester's stated use, the Corporation shall seek additional clarification before assigning the request to a specific category.

(ii) *Educational and noncommercial scientific institution requesters.* For purposes of this section, the term *educational institution* refers to a preschool, a public or private elementary or secondary school, an institution of graduate higher education, an institution of undergraduate higher education, an institution of professional education, or an institution of vocational education, which operates a program or programs of scholarly research. The term *noncommercial scientific institution* refers to an institution that is not operated on a *commercial* basis, as that term is used in paragraph (d)(1)(i) of this section, and which is operated solely for the purpose of conducting scientific research the results of which are not intended to promote any particular product or industry. To be eligible for inclusion in this category, requesters must show that the request is made as authorized by and under the auspices of a qualifying institution, and that the records are not sought for a commercial use, but are sought in furtherance of scholarly (if the request is from an educational institution) or scientific (if the request is from a non-commercial scientific institution) research.

(iii) *Requesters who are representatives of the news media.* For purposes of this section, the term *representative of the news media* refers to any person actively gathering information for an entity that is organized and operated to publish or broadcast news to the public. Examples of news media entities include television or radio stations broadcasting to the public at large, and publishers of periodicals (but only in those instances when they can qualify as disseminators of *news*) who make their products available for purchase or subscription by the general public. These examples are not intended to be all-inclusive. In the case of *freelance* journalists, they may be regarded as working for a news organization if they demonstrate a solid basis for expecting publication through that organization, even though not actually employed by it. A publication contract would be the clearest proof, but the Corporation may also look at the past publication record of a requester in making this determination. To be eligible for inclusion in this category, a requester must meet the criteria above, and his or her request must not be made for a commercial use. In reference to this class of requester, a request for records supporting the news dissemination function of the requester shall not be considered to be a request that is for a commercial use.

(iv) All other requesters.

(2) *Limitations on fees to be charged—*
(i) *Commercial use requesters.* Commercial use requesters shall be assessed the full direct costs for searching for, reviewing, and duplicating records, in accordance with the fee schedule at paragraph (d)(9) of this section. Commercial use requesters are not entitled to the free search time or free pages of duplication provided to other categories of requesters.

(ii) *Educational and noncommercial scientific institution requesters.* Requesters in this category may be assessed fees only for duplication of records in excess of the first 100 pages. Requesters in this category may not be assessed fees for search or review.

(iii) *Requesters who are representatives of the news media.* Requesters in this category may be assessed fees only for duplication of records in excess of the

§4100.4

24 CFR Ch. XXV (4-1-11 Edition)

first 100 pages. Requesters in this category may not be assessed fees for research or review.

(iv) *All other requesters.* Requesters who do not fit into any of the categories above shall be assessed fees only for searching and duplicating records, except that the first 100 pages of duplication and the first two hours of search time shall be furnished without charge. Requesters in this category may not be assessed fees for review.

(v) *Review of records.* Charges will be assessed only for the initial review of the located documents and not for time spent at the administrative appeal level on an exemption applied at the initial determination level. However, where records or portions of records are withheld in full under an exemption which is subsequently determined not to apply, and these records are reviewed again to determine the applicability of other exemptions not previously considered, charges for review are properly assessable.

(vi) *Additional copies.* The Corporation will normally furnish only one copy of any record. The allowance of 100 free pages of duplication under paragraphs (d)(2) (ii), (iii), and (iv) of this section shall not apply to additional copies furnished at the request of the record requester. Full duplication fees shall be assessed for each page of each such additional copy.

(3) *Charges for unsuccessful search.* Where applicable under paragraph (d)(2) of this section search fees may be assessed for time spent searching, even if the Corporation fails to locate the records or if records located are determined to be exempt from disclosure.

(4) *Notice of anticipated fees in excess of \$25.00.* Unless the person making the request states in his or her initial request that he or she will pay all costs regardless of amount, the Corporation will notify him or her as soon as possible if there is reason to believe that the cost for obtaining access to and/or copies of such records will exceed \$25. If such notice is given, the time limitations contained in the Freedom of Information Act shall not commence until the person making the initial request agrees in writing to pay such cost.

(5) *Advance payments.* The Communications Director is authorized to require an advance payment of an amount up to the full estimated charges whenever he or she determines that:

(i) The allowable charges that a requester may be required to pay are likely to exceed \$250 and the requester has no history of payment and cannot provide satisfactory assurance that payment will be made; or

(ii) A requester has previously failed to pay a fee charged in a timely manner.

If such a payment is required, the time limitations contained in the Freedom of Information Act shall not commence until payment is made.

(6) *Charging interest.* The Corporation will assess interest charges on any unpaid fees starting on the 31st day following the day on which the billing for fees was sent to the requester. Interest will be at the rate prescribed in 31 U.S.C. 3717 and will accrue from the date of the billing. Receipt of the fee by the Corporation, even if not processed, will stay the accrual of interest. Interest is not chargeable for unpaid advance payments under paragraph (d)(5) of this section.

(7) *Aggregating requests.* A requester may not file multiple requests at the same time, each seeking portions of the document or documents, solely in order to avoid payment of fees. When the Corporation reasonably believes that a requester, or a group of requesters acting in concert, is attempting to break a request down into a series of requests for the purpose of evading the assessment of fees, the Corporation may aggregate any such requests and charge accordingly.

(8) *Waiver or reduction of fee.* The Corporation will furnish documents without charge or at a reduced charge when it is determined that disclosure of the information is in the public interest because it is likely to contribute significantly to public understanding of the operations or activities of the Corporation and is not primarily in the commercial interest of the requester. In making a request for a waiver or reduction of fees, a requester should include a clear statement of his or her interest in the requested documents: The

Neighborhood Reinvestment Corporation

§ 4100.4

proposed use for the documents and whether the requester will derive income or other benefit from such use; and a statement of how the public will benefit from such use. Determinations concerning waiver or reduction of fees shall be made by the Executive Director, or his or her designee.

(9) *Schedule of fees.* Fees for searching for, reviewing, duplicating, and providing records and information of the Corporation under this section will be assessed in accordance with the following schedule:

(i) *Manual search.* For each quarter hour or fraction thereof: \$3.37.

(ii) *Computer search.* For each quarter hour or fraction thereof: \$3.37.

(iii) *Review.* For each quarter hour or fraction thereof: \$4.87.

(iv) *Duplication.*

(A) For a paper photocopy of an existing paper record, \$.10 per page.

(B) For duplication of records other than existing paper records (such as computer-stored information, audio or video tapes, microfiche or microfilm), the fee shall equal the actual direct cost of production and duplication of the records or information in a form that is reasonably usable by the requester.

(10) *Processing costs.* The Communications Director will waive payment in instances in which the costs of routine collection and processing of the fee are likely to equal or exceed the amount of the fee.

[49 FR 12700, Mar. 30, 1984, as amended at 54 FR 50953, Dec. 19, 1989]

FINDING AIDS

A list of CFR titles, subtitles, chapters, subchapters and parts and an alphabetical list of agencies publishing in the CFR are included in the CFR Index and Finding Aids volume to the Code of Federal Regulations which is published separately and revised annually.

Table of CFR Titles and Chapters
Alphabetical List of Agencies Appearing in the CFR
List of CFR Sections Affected

Table of CFR Titles and Chapters

(Revised as of April 1, 2011)

Title 1—General Provisions

- I Administrative Committee of the Federal Register (Parts 1—49)
- II Office of the Federal Register (Parts 50—299)
- III Administrative Conference of the United States (Parts 300—399)
- IV Miscellaneous Agencies (Parts 400—500)

Title 2—Grants and Agreements

SUBTITLE A—OFFICE OF MANAGEMENT AND BUDGET GUIDANCE FOR GRANTS AND AGREEMENTS

- I Office of Management and Budget Governmentwide Guidance for Grants and Agreements (Parts 100—199)
- II Office of Management and Budget Circulars and Guidance (200—299)

SUBTITLE B—FEDERAL AGENCY REGULATIONS FOR GRANTS AND AGREEMENTS

- III Department of Health and Human Services (Parts 300—399)
- IV Department of Agriculture (Parts 400—499)
- VI Department of State (Parts 600—699)
- VIII Department of Veterans Affairs (Parts 800—899)
- IX Department of Energy (Parts 900—999)
- XI Department of Defense (Parts 1100—1199)
- XII Department of Transportation (Parts 1200—1299)
- XIII Department of Commerce (Parts 1300—1399)
- XIV Department of the Interior (Parts 1400—1499)
- XV Environmental Protection Agency (Parts 1500—1599)
- XVIII National Aeronautics and Space Administration (Parts 1880—1899)
- XX United States Nuclear Regulatory Commission (Parts 2000—2099)
- XXII Corporation for National and Community Service (Parts 2200—2299)
- XXIII Social Security Administration (Parts 2300—2399)
- XXIV Housing and Urban Development (Parts 2400—2499)
- XXV National Science Foundation (Parts 2500—2599)
- XXVI National Archives and Records Administration (Parts 2600—2699)
- XXVII Small Business Administration (Parts 2700—2799)
- XXVIII Department of Justice (Parts 2800—2899)
- XXX Department of Homeland Security (Parts 3000—3099)

Title 2—Grants and Agreements—Continued

Chap.	
XXXI	Institute of Museum and Library Services (Parts 3100—3199)
XXXII	National Endowment for the Arts (Parts 3200—3299)
XXXIII	National Endowment for the Humanities (Parts 3300—3399)
XXXV	Export-Import Bank of the United States (Parts 3500—3599)
XXXVII	Peace Corps (Parts 3700—3799)
LVIII	Election Assistance Commission (Parts 5800—5899)

Title 3—The President

I	Executive Office of the President (Parts 100—199)
---	---

Title 4—Accounts

I	Government Accountability Office (Parts 1—99)
II	Recovery Accountability and Transparency Board (Parts 200—299)

Title 5—Administrative Personnel

I	Office of Personnel Management (Parts 1—1199)
II	Merit Systems Protection Board (Parts 1200—1299)
III	Office of Management and Budget (Parts 1300—1399)
V	The International Organizations Employees Loyalty Board (Parts 1500—1599)
VI	Federal Retirement Thrift Investment Board (Parts 1600—1699)
VIII	Office of Special Counsel (Parts 1800—1899)
IX	Appalachian Regional Commission (Parts 1900—1999)
XI	Armed Forces Retirement Home (Parts 2100—2199)
XIV	Federal Labor Relations Authority, General Counsel of the Federal Labor Relations Authority and Federal Service Impasses Panel (Parts 2400—2499)
XV	Office of Administration, Executive Office of the President (Parts 2500—2599)
XVI	Office of Government Ethics (Parts 2600—2699)
XXI	Department of the Treasury (Parts 3100—3199)
XXII	Federal Deposit Insurance Corporation (Parts 3200—3299)
XXIII	Department of Energy (Parts 3300—3399)
XXIV	Federal Energy Regulatory Commission (Parts 3400—3499)
XXV	Department of the Interior (Parts 3500—3599)
XXVI	Department of Defense (Parts 3600—3699)
XXVIII	Department of Justice (Parts 3800—3899)
XXIX	Federal Communications Commission (Parts 3900—3999)
XXX	Farm Credit System Insurance Corporation (Parts 4000—4099)
XXXI	Farm Credit Administration (Parts 4100—4199)
XXXIII	Overseas Private Investment Corporation (Parts 4300—4399)
XXXIV	Securities and Exchange Commission (Parts 4400—4499)

Title 5—Administrative Personnel—Continued

Chap.	
XXXV	Office of Personnel Management (Parts 4500—4599)
XL	Interstate Commerce Commission (Parts 5000—5099)
XLI	Commodity Futures Trading Commission (Parts 5100—5199)
XLII	Department of Labor (Parts 5200—5299)
XLIII	National Science Foundation (Parts 5300—5399)
XLV	Department of Health and Human Services (Parts 5500—5599)
XLVI	Postal Rate Commission (Parts 5600—5699)
XLVII	Federal Trade Commission (Parts 5700—5799)
XLVIII	Nuclear Regulatory Commission (Parts 5800—5899)
XLIX	Federal Labor Relations Authority (Parts 5900—5999)
L	Department of Transportation (Parts 6000—6099)
LII	Export-Import Bank of the United States (Parts 6200—6299)
LIII	Department of Education (Parts 6300—6399)
LIV	Environmental Protection Agency (Parts 6400—6499)
LV	National Endowment for the Arts (Parts 6500—6599)
LVI	National Endowment for the Humanities (Parts 6600—6699)
LVII	General Services Administration (Parts 6700—6799)
LVIII	Board of Governors of the Federal Reserve System (Parts 6800—6899)
LIX	National Aeronautics and Space Administration (Parts 6900—6999)
LX	United States Postal Service (Parts 7000—7099)
LXI	National Labor Relations Board (Parts 7100—7199)
LXII	Equal Employment Opportunity Commission (Parts 7200—7299)
LXIII	Inter-American Foundation (Parts 7300—7399)
LXIV	Merit Systems Protection Board (Parts 7400—7499)
LXV	Department of Housing and Urban Development (Parts 7500—7599)
LXVI	National Archives and Records Administration (Parts 7600—7699)
LXVII	Institute of Museum and Library Services (Parts 7700—7799)
LXVIII	Commission on Civil Rights (Parts 7800—7899)
LXIX	Tennessee Valley Authority (Parts 7900—7999)
LXXI	Consumer Product Safety Commission (Parts 8100—8199)
LXXII	Special Inspector General for Iraq Reconstruction (Parts 8200—8299)
LXXIII	Department of Agriculture (Parts 8300—8399)
LXXIV	Federal Mine Safety and Health Review Commission (Parts 8400—8499)
LXXVI	Federal Retirement Thrift Investment Board (Parts 8600—8699)
LXXVII	Office of Management and Budget (Parts 8700—8799)
LXXX	Federal Housing Finance Agency (Parts 8700—8799)
LXXXII	Special Inspector General for Iraq Reconstruction (Parts 9200—9299)
XCVII	Department of Homeland Security Human Resources Management System (Department of Homeland Security—Office of Personnel Management) (Parts 9700—9799)

Title 5—Administrative Personnel—Continued

Chap.

- XCIX Department of Defense Human Resources Management and Labor Relations Systems (Department of Defense—Office of Personnel Management) (Parts 9900—9999)

Title 6—Domestic Security

- I Department of Homeland Security, Office of the Secretary (Parts 0—99)

Title 7—Agriculture

SUBTITLE A—OFFICE OF THE SECRETARY OF AGRICULTURE (PARTS 0—26)

SUBTITLE B—REGULATIONS OF THE DEPARTMENT OF AGRICULTURE

- I Agricultural Marketing Service (Standards, Inspections, Marketing Practices), Department of Agriculture (Parts 27—209)
- II Food and Nutrition Service, Department of Agriculture (Parts 210—299)
- III Animal and Plant Health Inspection Service, Department of Agriculture (Parts 300—399)
- IV Federal Crop Insurance Corporation, Department of Agriculture (Parts 400—499)
- V Agricultural Research Service, Department of Agriculture (Parts 500—599)
- VI Natural Resources Conservation Service, Department of Agriculture (Parts 600—699)
- VII Farm Service Agency, Department of Agriculture (Parts 700—799)
- VIII Grain Inspection, Packers and Stockyards Administration (Federal Grain Inspection Service), Department of Agriculture (Parts 800—899)
- IX Agricultural Marketing Service (Marketing Agreements and Orders; Fruits, Vegetables, Nuts), Department of Agriculture (Parts 900—999)
- X Agricultural Marketing Service (Marketing Agreements and Orders; Milk), Department of Agriculture (Parts 1000—1199)
- XI Agricultural Marketing Service (Marketing Agreements and Orders; Miscellaneous Commodities), Department of Agriculture (Parts 1200—1299)
- XIV Commodity Credit Corporation, Department of Agriculture (Parts 1400—1499)
- XV Foreign Agricultural Service, Department of Agriculture (Parts 1500—1599)
- XVI Rural Telephone Bank, Department of Agriculture (Parts 1600—1699)
- XVII Rural Utilities Service, Department of Agriculture (Parts 1700—1799)
- XVIII Rural Housing Service, Rural Business-Cooperative Service, Rural Utilities Service, and Farm Service Agency, Department of Agriculture (Parts 1800—2099)
- XX Local Television Loan Guarantee Board (Parts 2200—2299)

Title 7—Agriculture—Continued

Chap.	
XXVI	Office of Inspector General, Department of Agriculture (Parts 2600—2699)
XXVII	Office of Information Resources Management, Department of Agriculture (Parts 2700—2799)
XXVIII	Office of Operations, Department of Agriculture (Parts 2800—2899)
XXIX	Office of Energy Policy and New Uses, Department of Agriculture (Parts 2900—2999)
XXX	Office of the Chief Financial Officer, Department of Agriculture (Parts 3000—3099)
XXXI	Office of Environmental Quality, Department of Agriculture (Parts 3100—3199)
XXXII	Office of Procurement and Property Management, Department of Agriculture (Parts 3200—3299)
XXXIII	Office of Transportation, Department of Agriculture (Parts 3300—3399)
XXXIV	National Institute of Food and Agriculture (Parts 3400—3499)
XXXV	Rural Housing Service, Department of Agriculture (Parts 3500—3599)
XXXVI	National Agricultural Statistics Service, Department of Agriculture (Parts 3600—3699)
XXXVII	Economic Research Service, Department of Agriculture (Parts 3700—3799)
XXXVIII	World Agricultural Outlook Board, Department of Agriculture (Parts 3800—3899)
XLI	[Reserved]
XLII	Rural Business-Cooperative Service and Rural Utilities Service, Department of Agriculture (Parts 4200—4299)
L	Rural Business-Cooperative Service, Rural Housing Service, and Rural Utilities Service, Department of Agriculture (Parts 5000—5099)

Title 8—Aliens and Nationality

I	Department of Homeland Security (Immigration and Naturalization) (Parts 1—499)
V	Executive Office for Immigration Review, Department of Justice (Parts 1000—1399)

Title 9—Animals and Animal Products

I	Animal and Plant Health Inspection Service, Department of Agriculture (Parts 1—199)
II	Grain Inspection, Packers and Stockyards Administration (Packers and Stockyards Programs), Department of Agriculture (Parts 200—299)
III	Food Safety and Inspection Service, Department of Agriculture (Parts 300—599)

Title 10—Energy

- Chap.
- I Nuclear Regulatory Commission (Parts 0—199)
 - II Department of Energy (Parts 200—699)
 - III Department of Energy (Parts 700—999)
 - X Department of Energy (General Provisions) (Parts 1000—1099)
 - XIII Nuclear Waste Technical Review Board (Parts 1303—1399)
 - XVII Defense Nuclear Facilities Safety Board (Parts 1700—1799)
 - XVIII Northeast Interstate Low-Level Radioactive Waste Commission (Parts 1800—1899)

Title 11—Federal Elections

- I Federal Election Commission (Parts 1—9099)
- II Election Assistance Commission (Parts 9400—9499)

Title 12—Banks and Banking

- I Comptroller of the Currency, Department of the Treasury (Parts 1—199)
- II Federal Reserve System (Parts 200—299)
- III Federal Deposit Insurance Corporation (Parts 300—399)
- IV Export-Import Bank of the United States (Parts 400—499)
- V Office of Thrift Supervision, Department of the Treasury (Parts 500—599)
- VI Farm Credit Administration (Parts 600—699)
- VII National Credit Union Administration (Parts 700—799)
- VIII Federal Financing Bank (Parts 800—899)
- IX Federal Housing Finance Board (Parts 900—999)
- XI Federal Financial Institutions Examination Council (Parts 1100—1199)
- XII Federal Housing Finance Agency (Parts 1200—1299)
- XIV Farm Credit System Insurance Corporation (Parts 1400—1499)
- XV Department of the Treasury (Parts 1500—1599)
- XVII Office of Federal Housing Enterprise Oversight, Department of Housing and Urban Development (Parts 1700—1799)
- XVIII Community Development Financial Institutions Fund, Department of the Treasury (Parts 1800—1899)

Title 13—Business Credit and Assistance

- I Small Business Administration (Parts 1—199)
- III Economic Development Administration, Department of Commerce (Parts 300—399)
- IV Emergency Steel Guarantee Loan Board (Parts 400—499)
- V Emergency Oil and Gas Guaranteed Loan Board (Parts 500—599)

Title 14—Aeronautics and Space

Chap.

- I Federal Aviation Administration, Department of Transportation (Parts 1—199)
- II Office of the Secretary, Department of Transportation (Aviation Proceedings) (Parts 200—399)
- III Commercial Space Transportation, Federal Aviation Administration, Department of Transportation (Parts 400—499)
- V National Aeronautics and Space Administration (Parts 1200—1299)
- VI Air Transportation System Stabilization (Parts 1300—1399)

Title 15—Commerce and Foreign Trade

SUBTITLE A—OFFICE OF THE SECRETARY OF COMMERCE (PARTS 0—29)

SUBTITLE B—REGULATIONS RELATING TO COMMERCE AND FOREIGN TRADE

- I Bureau of the Census, Department of Commerce (Parts 30—199)
 - II National Institute of Standards and Technology, Department of Commerce (Parts 200—299)
 - III International Trade Administration, Department of Commerce (Parts 300—399)
 - IV Foreign-Trade Zones Board, Department of Commerce (Parts 400—499)
 - VII Bureau of Industry and Security, Department of Commerce (Parts 700—799)
 - VIII Bureau of Economic Analysis, Department of Commerce (Parts 800—899)
 - IX National Oceanic and Atmospheric Administration, Department of Commerce (Parts 900—999)
 - XI Technology Administration, Department of Commerce (Parts 1100—1199)
 - XIII East-West Foreign Trade Board (Parts 1300—1399)
 - XIV Minority Business Development Agency (Parts 1400—1499)
- SUBTITLE C—REGULATIONS RELATING TO FOREIGN TRADE AGREEMENTS
- XX Office of the United States Trade Representative (Parts 2000—2099)
- SUBTITLE D—REGULATIONS RELATING TO TELECOMMUNICATIONS AND INFORMATION
- XXIII National Telecommunications and Information Administration, Department of Commerce (Parts 2300—2399)

Title 16—Commercial Practices

- I Federal Trade Commission (Parts 0—999)
- II Consumer Product Safety Commission (Parts 1000—1799)

Title 17—Commodity and Securities Exchanges

Chap.

- I Commodity Futures Trading Commission (Parts 1—199)
- II Securities and Exchange Commission (Parts 200—399)
- IV Department of the Treasury (Parts 400—499)

Title 18—Conservation of Power and Water Resources

- I Federal Energy Regulatory Commission, Department of Energy (Parts 1—399)
- III Delaware River Basin Commission (Parts 400—499)
- VI Water Resources Council (Parts 700—799)
- VIII Susquehanna River Basin Commission (Parts 800—899)
- XIII Tennessee Valley Authority (Parts 1300—1399)

Title 19—Customs Duties

- I U.S. Customs and Border Protection, Department of Homeland Security; Department of the Treasury (Parts 0—199)
- II United States International Trade Commission (Parts 200—299)
- III International Trade Administration, Department of Commerce (Parts 300—399)
- IV U.S. Immigration and Customs Enforcement, Department of Homeland Security (Parts 400—599)

Title 20—Employees' Benefits

- I Office of Workers' Compensation Programs, Department of Labor (Parts 1—199)
- II Railroad Retirement Board (Parts 200—399)
- III Social Security Administration (Parts 400—499)
- IV Employees Compensation Appeals Board, Department of Labor (Parts 500—599)
- V Employment and Training Administration, Department of Labor (Parts 600—699)
- VI Office of Workers' Compensation Programs, Department of Labor (Parts 700—799)
- VII Benefits Review Board, Department of Labor (Parts 800—899)
- VIII Joint Board for the Enrollment of Actuaries (Parts 900—999)
- IX Office of the Assistant Secretary for Veterans' Employment and Training Service, Department of Labor (Parts 1000—1099)

Title 21—Food and Drugs

- I Food and Drug Administration, Department of Health and Human Services (Parts 1—1299)
- II Drug Enforcement Administration, Department of Justice (Parts 1300—1399)
- III Office of National Drug Control Policy (Parts 1400—1499)

Title 22—Foreign Relations

Chap.

- I Department of State (Parts 1—199)
- II Agency for International Development (Parts 200—299)
- III Peace Corps (Parts 300—399)
- IV International Joint Commission, United States and Canada (Parts 400—499)
- V Broadcasting Board of Governors (Parts 500—599)
- VII Overseas Private Investment Corporation (Parts 700—799)
- IX Foreign Service Grievance Board (Parts 900—999)
- X Inter-American Foundation (Parts 1000—1099)
- XI International Boundary and Water Commission, United States and Mexico, United States Section (Parts 1100—1199)
- XII United States International Development Cooperation Agency (Parts 1200—1299)
- XIII Millenium Challenge Corporation (Parts 1300—1399)
- XIV Foreign Service Labor Relations Board; Federal Labor Relations Authority; General Counsel of the Federal Labor Relations Authority; and the Foreign Service Impasse Disputes Panel (Parts 1400—1499)
- XV African Development Foundation (Parts 1500—1599)
- XVI Japan-United States Friendship Commission (Parts 1600—1699)
- XVII United States Institute of Peace (Parts 1700—1799)

Title 23—Highways

- I Federal Highway Administration, Department of Transportation (Parts 1—999)
- II National Highway Traffic Safety Administration and Federal Highway Administration, Department of Transportation (Parts 1200—1299)
- III National Highway Traffic Safety Administration, Department of Transportation (Parts 1300—1399)

Title 24—Housing and Urban Development

SUBTITLE A—OFFICE OF THE SECRETARY, DEPARTMENT OF HOUSING AND URBAN DEVELOPMENT (PARTS 0—99)

SUBTITLE B—REGULATIONS RELATING TO HOUSING AND URBAN DEVELOPMENT

- I Office of Assistant Secretary for Equal Opportunity, Department of Housing and Urban Development (Parts 100—199)
- II Office of Assistant Secretary for Housing-Federal Housing Commissioner, Department of Housing and Urban Development (Parts 200—299)
- III Government National Mortgage Association, Department of Housing and Urban Development (Parts 300—399)
- IV Office of Housing and Office of Multifamily Housing Assistance Restructuring, Department of Housing and Urban Development (Parts 400—499)

Title 24—Housing and Urban Development—Continued

Chap.

- V Office of Assistant Secretary for Community Planning and Development, Department of Housing and Urban Development (Parts 500—599)
- VI Office of Assistant Secretary for Community Planning and Development, Department of Housing and Urban Development (Parts 600—699) [Reserved]
- VII Office of the Secretary, Department of Housing and Urban Development (Housing Assistance Programs and Public and Indian Housing Programs) (Parts 700—799)
- VIII Office of the Assistant Secretary for Housing—Federal Housing Commissioner, Department of Housing and Urban Development (Section 8 Housing Assistance Programs, Section 202 Direct Loan Program, Section 202 Supportive Housing for the Elderly Program and Section 811 Supportive Housing for Persons With Disabilities Program) (Parts 800—899)
- IX Office of Assistant Secretary for Public and Indian Housing, Department of Housing and Urban Development (Parts 900—1699)
- X Office of Assistant Secretary for Housing—Federal Housing Commissioner, Department of Housing and Urban Development (Interstate Land Sales Registration Program) (Parts 1700—1799)
- XII Office of Inspector General, Department of Housing and Urban Development (Parts 2000—2099)
- XV Emergency Mortgage Insurance and Loan Programs, Department of Housing and Urban Development (Parts 2700—2799)
- XX Office of Assistant Secretary for Housing—Federal Housing Commissioner, Department of Housing and Urban Development (Parts 3200—3899)
- XXIV Board of Directors of the HOPE for Homeowners Program (Parts 4000—4099)
- XXV Neighborhood Reinvestment Corporation (Parts 4100—4199)

Title 25—Indians

- I Bureau of Indian Affairs, Department of the Interior (Parts 1—299)
- II Indian Arts and Crafts Board, Department of the Interior (Parts 300—399)
- III National Indian Gaming Commission, Department of the Interior (Parts 500—599)
- IV Office of Navajo and Hopi Indian Relocation (Parts 700—799)
- V Bureau of Indian Affairs, Department of the Interior, and Indian Health Service, Department of Health and Human Services (Part 900)
- VI Office of the Assistant Secretary-Indian Affairs, Department of the Interior (Parts 1000—1199)
- VII Office of the Special Trustee for American Indians, Department of the Interior (Parts 1200—1299)

Title 26—Internal Revenue

Chap.

- I Internal Revenue Service, Department of the Treasury (Parts 1—899)

Title 27—Alcohol, Tobacco Products and Firearms

- I Alcohol and Tobacco Tax and Trade Bureau, Department of the Treasury (Parts 1—399)
- II Bureau of Alcohol, Tobacco, Firearms, and Explosives, Department of Justice (Parts 400—699)

Title 28—Judicial Administration

- I Department of Justice (Parts 0—299)
- III Federal Prison Industries, Inc., Department of Justice (Parts 300—399)
- V Bureau of Prisons, Department of Justice (Parts 500—599)
- VI Offices of Independent Counsel, Department of Justice (Parts 600—699)
- VII Office of Independent Counsel (Parts 700—799)
- VIII Court Services and Offender Supervision Agency for the District of Columbia (Parts 800—899)
- IX National Crime Prevention and Privacy Compact Council (Parts 900—999)
- XI Department of Justice and Department of State (Parts 1100—1199)

Title 29—Labor

SUBTITLE A—OFFICE OF THE SECRETARY OF LABOR (PARTS 0—99)

SUBTITLE B—REGULATIONS RELATING TO LABOR

- I National Labor Relations Board (Parts 100—199)
- II Office of Labor-Management Standards, Department of Labor (Parts 200—299)
- III National Railroad Adjustment Board (Parts 300—399)
- IV Office of Labor-Management Standards, Department of Labor (Parts 400—499)
- V Wage and Hour Division, Department of Labor (Parts 500—899)
- IX Construction Industry Collective Bargaining Commission (Parts 900—999)
- X National Mediation Board (Parts 1200—1299)
- XII Federal Mediation and Conciliation Service (Parts 1400—1499)
- XIV Equal Employment Opportunity Commission (Parts 1600—1699)
- XVII Occupational Safety and Health Administration, Department of Labor (Parts 1900—1999)
- XX Occupational Safety and Health Review Commission (Parts 2200—2499)
- XXV Employee Benefits Security Administration, Department of Labor (Parts 2500—2599)

Title 29—Labor—Continued

- Chap.
- XXVII Federal Mine Safety and Health Review Commission (Parts 2700—2799)
- XL Pension Benefit Guaranty Corporation (Parts 4000—4999)

Title 30—Mineral Resources

- I Mine Safety and Health Administration, Department of Labor (Parts 1—199)
- II Bureau of Ocean Energy Management, Regulation, and Enforcement, Department of the Interior (Parts 200—299)
- IV Geological Survey, Department of the Interior (Parts 400—499)
- VII Office of Surface Mining Reclamation and Enforcement, Department of the Interior (Parts 700—999)
- XII Office of Natural Resources Revenue, Department of the Interior (Parts 1200—1299)

Title 31—Money and Finance: Treasury

SUBTITLE A—OFFICE OF THE SECRETARY OF THE TREASURY (PARTS 0—50)

SUBTITLE B—REGULATIONS RELATING TO MONEY AND FINANCE

- I Monetary Offices, Department of the Treasury (Parts 51—199)
- II Fiscal Service, Department of the Treasury (Parts 200—399)
- IV Secret Service, Department of the Treasury (Parts 400—499)
- V Office of Foreign Assets Control, Department of the Treasury (Parts 500—599)
- VI Bureau of Engraving and Printing, Department of the Treasury (Parts 600—699)
- VII Federal Law Enforcement Training Center, Department of the Treasury (Parts 700—799)
- VIII Office of International Investment, Department of the Treasury (Parts 800—899)
- IX Federal Claims Collection Standards (Department of the Treasury—Department of Justice) (Parts 900—999)
- X Financial Crimes Enforcement Network, Department of the Treasury (Parts 1000—1099)

Title 32—National Defense

SUBTITLE A—DEPARTMENT OF DEFENSE

- I Office of the Secretary of Defense (Parts 1—399)
- V Department of the Army (Parts 400—699)
- VI Department of the Navy (Parts 700—799)
- VII Department of the Air Force (Parts 800—1099)

SUBTITLE B—OTHER REGULATIONS RELATING TO NATIONAL DEFENSE

- XII Defense Logistics Agency (Parts 1200—1299)
- XVI Selective Service System (Parts 1600—1699)

Title 32—National Defense—Continued

Chap.	
XVII	Office of the Director of National Intelligence (Parts 1700—1799)
XVIII	National Counterintelligence Center (Parts 1800—1899)
XIX	Central Intelligence Agency (Parts 1900—1999)
XX	Information Security Oversight Office, National Archives and Records Administration (Parts 2000—2099)
XXI	National Security Council (Parts 2100—2199)
XXIV	Office of Science and Technology Policy (Parts 2400—2499)
XXVII	Office for Micronesian Status Negotiations (Parts 2700—2799)
XXVIII	Office of the Vice President of the United States (Parts 2800—2899)

Title 33—Navigation and Navigable Waters

I	Coast Guard, Department of Homeland Security (Parts 1—199)
II	Corps of Engineers, Department of the Army (Parts 200—399)
IV	Saint Lawrence Seaway Development Corporation, Department of Transportation (Parts 400—499)

Title 34—Education

	SUBTITLE A—OFFICE OF THE SECRETARY, DEPARTMENT OF EDUCATION (PARTS 1—99)
	SUBTITLE B—REGULATIONS OF THE OFFICES OF THE DEPARTMENT OF EDUCATION
I	Office for Civil Rights, Department of Education (Parts 100—199)
II	Office of Elementary and Secondary Education, Department of Education (Parts 200—299)
III	Office of Special Education and Rehabilitative Services, Department of Education (Parts 300—399)
IV	Office of Vocational and Adult Education, Department of Education (Parts 400—499)
V	Office of Bilingual Education and Minority Languages Affairs, Department of Education (Parts 500—599)
VI	Office of Postsecondary Education, Department of Education (Parts 600—699)
VII	Office of Educational Research and Improvement, Department of Education [Reserved]
XI	National Institute for Literacy (Parts 1100—1199)
	SUBTITLE C—REGULATIONS RELATING TO EDUCATION
XII	National Council on Disability (Parts 1200—1299)

Title 35 [Reserved]

Title 36—Parks, Forests, and Public Property

I	National Park Service, Department of the Interior (Parts 1—199)
II	Forest Service, Department of Agriculture (Parts 200—299)
III	Corps of Engineers, Department of the Army (Parts 300—399)

Title 36—Parks, Forests, and Public Property—Continued

Chap.

- IV American Battle Monuments Commission (Parts 400—499)
- V Smithsonian Institution (Parts 500—599)
- VI [Reserved]
- VII Library of Congress (Parts 700—799)
- VIII Advisory Council on Historic Preservation (Parts 800—899)
- IX Pennsylvania Avenue Development Corporation (Parts 900—999)
- X Presidio Trust (Parts 1000—1099)
- XI Architectural and Transportation Barriers Compliance Board (Parts 1100—1199)
- XII National Archives and Records Administration (Parts 1200—1299)
- XV Oklahoma City National Memorial Trust (Parts 1500—1599)
- XVI Morris K. Udall Scholarship and Excellence in National Environmental Policy Foundation (Parts 1600—1699)

Title 37—Patents, Trademarks, and Copyrights

- I United States Patent and Trademark Office, Department of Commerce (Parts 1—199)
- II Copyright Office, Library of Congress (Parts 200—299)
- III Copyright Royalty Board, Library of Congress (Parts 301—399)
- IV Assistant Secretary for Technology Policy, Department of Commerce (Parts 400—499)
- V Under Secretary for Technology, Department of Commerce (Parts 500—599)

Title 38—Pensions, Bonuses, and Veterans' Relief

- I Department of Veterans Affairs (Parts 0—99)
- II Armed Forces Retirement Home

Title 39—Postal Service

- I United States Postal Service (Parts 1—999)
- III Postal Regulatory Commission (Parts 3000—3099)

Title 40—Protection of Environment

- I Environmental Protection Agency (Parts 1—1099)
- IV Environmental Protection Agency and Department of Justice (Parts 1400—1499)
- V Council on Environmental Quality (Parts 1500—1599)
- VI Chemical Safety and Hazard Investigation Board (Parts 1600—1699)
- VII Environmental Protection Agency and Department of Defense; Uniform National Discharge Standards for Vessels of the Armed Forces (Parts 1700—1799)

Title 41—Public Contracts and Property Management

- Chap.
- SUBTITLE B—OTHER PROVISIONS RELATING TO PUBLIC CONTRACTS
- 50 Public Contracts, Department of Labor (Parts 50–1—50–999)
- 51 Committee for Purchase From People Who Are Blind or Severely Disabled (Parts 51–1—51–99)
- 60 Office of Federal Contract Compliance Programs, Equal Employment Opportunity, Department of Labor (Parts 60–1—60–999)
- 61 Office of the Assistant Secretary for Veterans' Employment and Training Service, Department of Labor (Parts 61–1—61–999)
- 62—100 [Reserved]
- SUBTITLE C—FEDERAL PROPERTY MANAGEMENT REGULATIONS SYSTEM
- 101 Federal Property Management Regulations (Parts 101–1—101–99)
- 102 Federal Management Regulation (Parts 102–1—102–299)
- 103—104 [Reserved]
- 105 General Services Administration (Parts 105–1—105–999)
- 109 Department of Energy Property Management Regulations (Parts 109–1—109–99)
- 114 Department of the Interior (Parts 114–1—114–99)
- 115 Environmental Protection Agency (Parts 115–1—115–99)
- 128 Department of Justice (Parts 128–1—128–99)
- 129—200 [Reserved]
- SUBTITLE D—OTHER PROVISIONS RELATING TO PROPERTY MANAGEMENT [RESERVED]
- SUBTITLE E—FEDERAL INFORMATION RESOURCES MANAGEMENT REGULATIONS SYSTEM [RESERVED]
- SUBTITLE F—FEDERAL TRAVEL REGULATION SYSTEM
- 300 General (Parts 300–1—300–99)
- 301 Temporary Duty (TDY) Travel Allowances (Parts 301–1—301–99)
- 302 Relocation Allowances (Parts 302–1—302–99)
- 303 Payment of Expenses Connected with the Death of Certain Employees (Part 303–1—303–99)
- 304 Payment of Travel Expenses from a Non-Federal Source (Parts 304–1—304–99)

Title 42—Public Health

- I Public Health Service, Department of Health and Human Services (Parts 1—199)
- IV Centers for Medicare & Medicaid Services, Department of Health and Human Services (Parts 400—499)
- V Office of Inspector General-Health Care, Department of Health and Human Services (Parts 1000—1999)

Title 43—Public Lands: Interior

- SUBTITLE A—OFFICE OF THE SECRETARY OF THE INTERIOR (PARTS 1—199)
- SUBTITLE B—REGULATIONS RELATING TO PUBLIC LANDS

Title 43—Public Lands: Interior—Continued

Chap.

- I Bureau of Reclamation, Department of the Interior (Parts 200—499)
- II Bureau of Land Management, Department of the Interior (Parts 1000—9999)
- III Utah Reclamation Mitigation and Conservation Commission (Parts 10000—10099)

Title 44—Emergency Management and Assistance

- I Federal Emergency Management Agency, Department of Homeland Security (Parts 0—399)
- IV Department of Commerce and Department of Transportation (Parts 400—499)

Title 45—Public Welfare

SUBTITLE A—DEPARTMENT OF HEALTH AND HUMAN SERVICES
(PARTS 1—199)

SUBTITLE B—REGULATIONS RELATING TO PUBLIC WELFARE

- II Office of Family Assistance (Assistance Programs), Administration for Children and Families, Department of Health and Human Services (Parts 200—299)
- III Office of Child Support Enforcement (Child Support Enforcement Program), Administration for Children and Families, Department of Health and Human Services (Parts 300—399)
- IV Office of Refugee Resettlement, Administration for Children and Families, Department of Health and Human Services (Parts 400—499)
- V Foreign Claims Settlement Commission of the United States, Department of Justice (Parts 500—599)
- VI National Science Foundation (Parts 600—699)
- VII Commission on Civil Rights (Parts 700—799)
- VIII Office of Personnel Management (Parts 800—899) [Reserved]
- X Office of Community Services, Administration for Children and Families, Department of Health and Human Services (Parts 1000—1099)
- XI National Foundation on the Arts and the Humanities (Parts 1100—1199)
- XII Corporation for National and Community Service (Parts 1200—1299)
- XIII Office of Human Development Services, Department of Health and Human Services (Parts 1300—1399)
- XVI Legal Services Corporation (Parts 1600—1699)
- XVII National Commission on Libraries and Information Science (Parts 1700—1799)
- XVIII Harry S. Truman Scholarship Foundation (Parts 1800—1899)
- XXI Commission on Fine Arts (Parts 2100—2199)
- XXIII Arctic Research Commission (Part 2301)
- XXIV James Madison Memorial Fellowship Foundation (Parts 2400—2499)

Title 45—Public Welfare—Continued

Chap.

- XXV Corporation for National and Community Service (Parts 2500—2599)

Title 46—Shipping

- I Coast Guard, Department of Homeland Security (Parts 1—199)
- II Maritime Administration, Department of Transportation (Parts 200—399)
- III Coast Guard (Great Lakes Pilotage), Department of Homeland Security (Parts 400—499)
- IV Federal Maritime Commission (Parts 500—599)

Title 47—Telecommunication

- I Federal Communications Commission (Parts 0—199)
- II Office of Science and Technology Policy and National Security Council (Parts 200—299)
- III National Telecommunications and Information Administration, Department of Commerce (Parts 300—399)
- IV National Telecommunications and Information Administration, Department of Commerce, and National Highway Traffic Safety Administration, Department of Transportation (Parts 400—499)

Title 48—Federal Acquisition Regulations System

- 1 Federal Acquisition Regulation (Parts 1—99)
- 2 Defense Acquisition Regulations System, Department of Defense (Parts 200—299)
- 3 Health and Human Services (Parts 300—399)
- 4 Department of Agriculture (Parts 400—499)
- 5 General Services Administration (Parts 500—599)
- 6 Department of State (Parts 600—699)
- 7 Agency for International Development (Parts 700—799)
- 8 Department of Veterans Affairs (Parts 800—899)
- 9 Department of Energy (Parts 900—999)
- 10 Department of the Treasury (Parts 1000—1099)
- 12 Department of Transportation (Parts 1200—1299)
- 13 Department of Commerce (Parts 1300—1399)
- 14 Department of the Interior (Parts 1400—1499)
- 15 Environmental Protection Agency (Parts 1500—1599)
- 16 Office of Personnel Management, Federal Employees Health Benefits Acquisition Regulation (Parts 1600—1699)
- 17 Office of Personnel Management (Parts 1700—1799)
- 18 National Aeronautics and Space Administration (Parts 1800—1899)
- 19 Broadcasting Board of Governors (Parts 1900—1999)
- 20 Nuclear Regulatory Commission (Parts 2000—2099)

Title 48—Federal Acquisition Regulations System—Continued

Chap.

- 21 Office of Personnel Management, Federal Employees Group Life Insurance Federal Acquisition Regulation (Parts 2100—2199)
- 23 Social Security Administration (Parts 2300—2399)
- 24 Department of Housing and Urban Development (Parts 2400—2499)
- 25 National Science Foundation (Parts 2500—2599)
- 28 Department of Justice (Parts 2800—2899)
- 29 Department of Labor (Parts 2900—2999)
- 30 Department of Homeland Security, Homeland Security Acquisition Regulation (HSAR) (Parts 3000—3099)
- 34 Department of Education Acquisition Regulation (Parts 3400—3499)
- 51 Department of the Army Acquisition Regulations (Parts 5100—5199)
- 52 Department of the Navy Acquisition Regulations (Parts 5200—5299)
- 53 Department of the Air Force Federal Acquisition Regulation Supplement [Reserved]
- 54 Defense Logistics Agency, Department of Defense (Parts 5400—5499)
- 57 African Development Foundation (Parts 5700—5799)
- 61 Civilian Board of Contract Appeals, General Services Administration (Parts 6100—6199)
- 63 Department of Transportation Board of Contract Appeals (Parts 6300—6399)
- 99 Cost Accounting Standards Board, Office of Federal Procurement Policy, Office of Management and Budget (Parts 9900—9999)

Title 49—Transportation

SUBTITLE A—OFFICE OF THE SECRETARY OF TRANSPORTATION
(PARTS 1—99)

SUBTITLE B—OTHER REGULATIONS RELATING TO TRANSPORTATION

- I Pipeline and Hazardous Materials Safety Administration, Department of Transportation (Parts 100—199)
- II Federal Railroad Administration, Department of Transportation (Parts 200—299)
- III Federal Motor Carrier Safety Administration, Department of Transportation (Parts 300—399)
- IV Coast Guard, Department of Homeland Security (Parts 400—499)
- V National Highway Traffic Safety Administration, Department of Transportation (Parts 500—599)
- VI Federal Transit Administration, Department of Transportation (Parts 600—699)
- VII National Railroad Passenger Corporation (AMTRAK) (Parts 700—799)
- VIII National Transportation Safety Board (Parts 800—999)

Title 49—Transportation—Continued

Chap.

- X Surface Transportation Board, Department of Transportation (Parts 1000—1399)
- XI Research and Innovative Technology Administration, Department of Transportation [Reserved]
- XII Transportation Security Administration, Department of Homeland Security (Parts 1500—1699)

Title 50—Wildlife and Fisheries

- I United States Fish and Wildlife Service, Department of the Interior (Parts 1—199)
- II National Marine Fisheries Service, National Oceanic and Atmospheric Administration, Department of Commerce (Parts 200—299)
- III International Fishing and Related Activities (Parts 300—399)
- IV Joint Regulations (United States Fish and Wildlife Service, Department of the Interior and National Marine Fisheries Service, National Oceanic and Atmospheric Administration, Department of Commerce); Endangered Species Committee Regulations (Parts 400—499)
- V Marine Mammal Commission (Parts 500—599)
- VI Fishery Conservation and Management, National Oceanic and Atmospheric Administration, Department of Commerce (Parts 600—699)

CFR Index and Finding Aids

Subject/Agency Index

List of Agency Prepared Indexes

Parallel Tables of Statutory Authorities and Rules

List of CFR Titles, Chapters, Subchapters, and Parts

Alphabetical List of Agencies Appearing in the CFR

Alphabetical List of Agencies Appearing in the CFR

(Revised as of April 1, 2011)

Agency	CFR Title, Subtitle or Chapter
Administrative Committee of the Federal Register	1, I
Administrative Conference of the United States	1, III
Advanced Research Projects Agency	32, I
Advisory Council on Historic Preservation	36, VIII
African Development Foundation	22, XV
Federal Acquisition Regulation	48, 57
Agency for International Development	22, II
Federal Acquisition Regulation	48, 7
Agricultural Marketing Service	7, I, IX, X, XI
Agricultural Research Service	7, V
Agriculture Department	2, IV; 5, LXXXIII
Agricultural Marketing Service	7, I, IX, X, XI
Agricultural Research Service	7, V
Animal and Plant Health Inspection Service	7, III; 9, I
Chief Financial Officer, Office of	7, XXX
Commodity Credit Corporation	7, XIV
Economic Research Service	7, XXXVII
Energy Policy and New Uses, Office of	2, IX; 7, XXIX
Environmental Quality, Office of	7, XXXI
Farm Service Agency	7, VII, XVIII
Federal Acquisition Regulation	48, 4
Federal Crop Insurance Corporation	7, IV
Food and Nutrition Service	7, II
Food Safety and Inspection Service	9, III
Foreign Agricultural Service	7, XV
Forest Service	36, II
Grain Inspection, Packers and Stockyards Administration	7, VIII; 9, II
Information Resources Management, Office of	7, XXXVII
Inspector General, Office of	7, XXXVI
National Agricultural Library	7, XLI
National Agricultural Statistics Service	7, XXXVI
National Institute of Food and Agriculture	7, XXXIV
Natural Resources Conservation Service	7, VI
Operations, Office of	7, XXVIII
Procurement and Property Management, Office of	7, XXXII
Rural Business-Cooperative Service	7, XVIII, XLII, L
Rural Development Administration	7, XLII
Rural Housing Service	7, XVIII, XXXV, L
Rural Telephone Bank	7, XVI
Rural Utilities Service	7, XVII, XVIII, XLII, L
Secretary of Agriculture, Office of	7, Subtitle A
Transportation, Office of	7, XXXIII
World Agricultural Outlook Board	7, XXXVIII
Air Force Department	32, VII
Federal Acquisition Regulation Supplement	48, 53
Air Transportation Stabilization Board	14, VI
Alcohol and Tobacco Tax and Trade Bureau	27, I
Alcohol, Tobacco, Firearms, and Explosives, Bureau of	27, II
AMTRAK	49, VII
American Battle Monuments Commission	36, IV
American Indians, Office of the Special Trustee	25, VII
Animal and Plant Health Inspection Service	7, III; 9, I
Appalachian Regional Commission	5, IX

Agency	CFR Title, Subtitle or Chapter
Architectural and Transportation Barriers Compliance Board	36, XI
Arctic Research Commission	45, XXIII
Armed Forces Retirement Home	5, XI
Army Department	32, V
Engineers, Corps of	33, II; 36, III
Federal Acquisition Regulation	48, 51
Bilingual Education and Minority Languages Affairs, Office of	34, V
Blind or Severely Disabled, Committee for Purchase From People Who Are	41, 51
Broadcasting Board of Governors	22, V
Federal Acquisition Regulation	48, 19
Bureau of Ocean Energy Management, Regulation, and Enforcement	30, II
Census Bureau	15, I
Centers for Medicare & Medicaid Services	42, IV
Central Intelligence Agency	32, XIX
Chief Financial Officer, Office of	7, XXX
Child Support Enforcement, Office of	45, III
Children and Families, Administration for	45, II, III, IV, X
Civil Rights, Commission on	5, LXVIII; 45, VII
Civil Rights, Office for	34, I
Coast Guard	33, I; 46, I; 49, IV
Coast Guard (Great Lakes Pilotage)	46, III
Commerce Department	44, IV; 50, VI
Census Bureau	15, I
Economic Affairs, Under Secretary	37, V
Economic Analysis, Bureau of	15, VIII
Economic Development Administration	13, III
Emergency Management and Assistance	44, IV
Federal Acquisition Regulation	48, 13
Fishery Conservation and Management	50, VI
Foreign-Trade Zones Board	15, IV
Industry and Security, Bureau of	15, VII
International Trade Administration	15, III; 19, III
National Institute of Standards and Technology	15, II
National Marine Fisheries Service	50, II, IV
National Oceanic and Atmospheric Administration	15, IX; 50, II, III, IV, VI
National Telecommunications and Information Administration	15, XXIII; 47, III, IV
National Weather Service	15, IX
Patent and Trademark Office, United States	37, I
Productivity, Technology and Innovation, Assistant Secretary for	37, IV
Secretary of Commerce, Office of	15, Subtitle A
Technology, Under Secretary for	37, V
Technology Administration	15, XI
Technology Policy, Assistant Secretary for	37, IV
Commercial Space Transportation	14, III
Commodity Credit Corporation	7, XIV
Commodity Futures Trading Commission	5, XLI; 17, I
Community Planning and Development, Office of Assistant Secretary for	24, V, VI
Community Services, Office of	45, X
Comptroller of the Currency	12, I
Construction Industry Collective Bargaining Commission	29, IX
Consumer Product Safety Commission	5, LXXI; 16, II
Copyright Office	37, II
Copyright Royalty Board	37, III
Corporation for National and Community Service	2, XXII; 45, XII, XXV
Cost Accounting Standards Board	48, 99
Council on Environmental Quality	40, V
Court Services and Offender Supervision Agency for the District of Columbia	28, VIII
Customs and Border Protection Bureau	19, I
Defense Contract Audit Agency	32, I
Defense Department	5, XXVI; 32, Subtitle A; 40, VII

Agency	CFR Title, Subtitle or Chapter
Advanced Research Projects Agency	32, I
Air Force Department	32, VII
Army Department	32, V; 33, II; 36, III, 48, 51
Defense Acquisition Regulations System	48, 2
Defense Intelligence Agency	32, I
Defense Logistics Agency	32, I, XII; 48, 54
Engineers, Corps of	33, II; 36, III
Human Resources Management and Labor Relations Systems	5, XCIX
National Imagery and Mapping Agency	32, I
Navy Department	32, VI; 48, 52
Secretary of Defense, Office of	2, XI; 32, I
Defense Contract Audit Agency	32, I
Defense Intelligence Agency	32, I
Defense Logistics Agency	32, XII; 48, 54
Defense Nuclear Facilities Safety Board	10, XVII
Delaware River Basin Commission	18, III
District of Columbia, Court Services and Offender Supervision Agency for the	28, VIII
Drug Enforcement Administration	21, II
East-West Foreign Trade Board	15, XIII
Economic Affairs, Under Secretary	37, V
Economic Analysis, Bureau of	15, VIII
Economic Development Administration	13, III
Economic Research Service	7, XXXVII
Education, Department of	5, LIII
Bilingual Education and Minority Languages Affairs, Office of	34, V
Civil Rights, Office for	34, I
Educational Research and Improvement, Office of	34, VII
Elementary and Secondary Education, Office of	34, II
Federal Acquisition Regulation	48, 34
Postsecondary Education, Office of	34, VI
Secretary of Education, Office of	34, Subtitle A
Special Education and Rehabilitative Services, Office of	34, III
Vocational and Adult Education, Office of	34, IV
Educational Research and Improvement, Office of	34, VII
Election Assistance Commission	2, LVIII; 11, II
Elementary and Secondary Education, Office of	34, II
Emergency Oil and Gas Guaranteed Loan Board	13, V
Emergency Steel Guarantee Loan Board	13, IV
Employee Benefits Security Administration	29, XXV
Employees' Compensation Appeals Board	20, IV
Employees Loyalty Board	5, V
Employment and Training Administration	20, V
Employment Standards Administration	20, VI
Endangered Species Committee	50, IV
Energy, Department of	5, XXIII; 10, II, III, X
Federal Acquisition Regulation	48, 9, 34
Federal Energy Regulatory Commission	5, XXIV; 18, I
Property Management Regulations	41, 109
Energy, Office of	7, XXIX
Engineers, Corps of	33, II; 36, III
Engraving and Printing, Bureau of	31, VI
Environmental Protection Agency	2, XV; 5, LIV; 40, I, IV, VII
Federal Acquisition Regulation	48, 15
Property Management Regulations	41, 115
Environmental Quality, Office of	7, XXXI
Equal Employment Opportunity Commission	5, LXII; 29, XIV
Equal Opportunity, Office of Assistant Secretary for	24, I
Executive Office of the President	3, I
Administration, Office of	5, XV
Environmental Quality, Council on	40, V
Management and Budget, Office of	5, III, LXXVII; 14, VI; 48, 99

Agency	CFR Title, Subtitle or Chapter
National Drug Control Policy, Office of	21, III
National Security Council	32, XXI; 47, 2
Presidential Documents	3
Science and Technology Policy, Office of	32, XXIV; 47, II
Trade Representative, Office of the United States	15, XX
Export-Import Bank of the United States	2, XXXV; 5, LII; 12, IV
Family Assistance, Office of	45, II
Farm Credit Administration	5, XXXI; 12, VI
Farm Credit System Insurance Corporation	5, XXX; 12, XIV
Farm Service Agency	7, VII, XVIII
Federal Acquisition Regulation	48, 1
Federal Aviation Administration	14, I
Commercial Space Transportation	14, III
Federal Claims Collection Standards	31, IX
Federal Communications Commission	5, XXIX; 47, I
Federal Contract Compliance Programs, Office of	41, 60
Federal Crop Insurance Corporation	7, IV
Federal Deposit Insurance Corporation	5, XXII; 12, III
Federal Election Commission	11, I
Federal Emergency Management Agency	44, I
Federal Employees Group Life Insurance Federal Acquisition Regulation	48, 21
Federal Employees Health Benefits Acquisition Regulation	48, 16
Federal Energy Regulatory Commission	5, XXIV; 18, I
Federal Financial Institutions Examination Council	12, XI
Federal Financing Bank	12, VIII
Federal Highway Administration	23, I, II
Federal Home Loan Mortgage Corporation	1, IV
Federal Housing Enterprise Oversight Office	12, XXVII
Federal Housing Finance Agency	5, LXXX; 12, XII
Federal Housing Finance Board	12, IX
Federal Labor Relations Authority	5, XIV, XLIX; 22, XIV
Federal Law Enforcement Training Center	31, VII
Federal Management Regulation	41, 102
Federal Maritime Commission	46, IV
Federal Mediation and Conciliation Service	29, XII
Federal Mine Safety and Health Review Commission	5, LXXIV; 29, XXVII
Federal Motor Carrier Safety Administration	49, III
Federal Prison Industries, Inc.	28, III
Federal Procurement Policy Office	48, 99
Federal Property Management Regulations	41, 101
Federal Railroad Administration	49, II
Federal Register, Administrative Committee of	1, I
Federal Register, Office of	1, II
Federal Reserve System	12, II
Board of Governors	5, LVIII
Federal Retirement Thrift Investment Board	5, VI, LXXXVI
Federal Service Impasses Panel	5, XIV
Federal Trade Commission	5, XLVII; 16, I
Federal Transit Administration	49, VI
Federal Travel Regulation System	41, Subtitle F
Financial Crimes Enforcement Network	31, X
Fine Arts, Commission on	45, XXI
Fiscal Service	31, II
Fish and Wildlife Service, United States	50, I, IV
Fishery Conservation and Management	50, VI
Food and Drug Administration	21, I
Food and Nutrition Service	7, II
Food Safety and Inspection Service	9, III
Foreign Agricultural Service	7, XV
Foreign Assets Control, Office of	31, V
Foreign Claims Settlement Commission of the United States	45, V
Foreign Service Grievance Board	22, IX
Foreign Service Impasse Disputes Panel	22, XIV
Foreign Service Labor Relations Board	22, XIV
Foreign-Trade Zones Board	15, IV
Forest Service	36, II

Agency	CFR Title, Subtitle or Chapter
General Services Administration	5, LVII; 41, 105
Contract Appeals, Board of	48, 61
Federal Acquisition Regulation	48, 5
Federal Management Regulation	41, 102
Federal Property Management Regulations	41, 101
Federal Travel Regulation System	41, Subtitle F
General	41, 300
Payment From a Non-Federal Source for Travel Expenses	41, 304
Payment of Expenses Connected With the Death of Certain Employees	41, 303
Relocation Allowances	41, 302
Temporary Duty (TDY) Travel Allowances	41, 301
Geological Survey	30, IV
Government Accountability Office	4, I
Government Ethics, Office of	5, XVI
Government National Mortgage Association	24, III
Grain Inspection, Packers and Stockyards Administration	7, VIII; 9, II
Harry S. Truman Scholarship Foundation	45, XVIII
Health and Human Services, Department of	2, III; 5, XLV; 45, Subtitle A,
Centers for Medicare & Medicaid Services	42, IV
Child Support Enforcement, Office of	45, III
Children and Families, Administration for	45, II, III, IV, X
Community Services, Office of	45, X
Family Assistance, Office of	45, II
Federal Acquisition Regulation	48, 3
Food and Drug Administration	21, I
Human Development Services, Office of	45, XIII
Indian Health Service	25, V
Inspector General (Health Care), Office of	42, V
Public Health Service	42, I
Refugee Resettlement, Office of	45, IV
Homeland Security, Department of	2, XXX; 6, I
Coast Guard	33, I; 46, I; 49, IV
Coast Guard (Great Lakes Pilotage)	46, III
Customs and Border Protection Bureau	19, I
Federal Emergency Management Agency	44, I
Human Resources Management and Labor Relations Systems	5, XCVII
Immigration and Customs Enforcement Bureau	19, IV
Immigration and Naturalization	8, I
Transportation Security Administration	49, XII
HOPE for Homeowners Program, Board of Directors of	24, XXIV
Housing and Urban Development, Department of	2, XXIV; 5, LXV; 24, Subtitle B
Community Planning and Development, Office of Assistant Secretary for	24, V, VI
Equal Opportunity, Office of Assistant Secretary for	24, I
Federal Acquisition Regulation	48, 24
Federal Housing Enterprise Oversight, Office of	12, XVII
Government National Mortgage Association	24, III
Housing—Federal Housing Commissioner, Office of Assistant Secretary for	24, II, VIII, X, XX
Housing, Office of, and Multifamily Housing Assistance Restructuring, Office of	24, IV
Inspector General, Office of	24, XII
Public and Indian Housing, Office of Assistant Secretary for Secretary, Office of	24, IX
Housing—Federal Housing Commissioner, Office of Assistant Secretary for	24, Subtitle A, VII
Housing, Office of, and Multifamily Housing Assistance Restructuring, Office of	24, II, VIII, X, XX
Housing, Office of, and Multifamily Housing Assistance Restructuring, Office of	24, IV
Human Development Services, Office of	45, XIII
Immigration and Customs Enforcement Bureau	19, IV
Immigration and Naturalization	8, I
Immigration Review, Executive Office for	8, V
Independent Counsel, Office of	28, VII

Agency	CFR Title, Subtitle or Chapter
Indian Affairs, Bureau of	25, I, V
Indian Affairs, Office of the Assistant Secretary	25, VI
Indian Arts and Crafts Board	25, II
Indian Health Service	25, V
Industry and Security, Bureau of	15, VII
Information Resources Management, Office of	7, XXVII
Information Security Oversight Office, National Archives and Records Administration	32, XX
Inspector General	
Agriculture Department	7, XXVI
Health and Human Services Department	42, V
Housing and Urban Development Department	24, XII
Institute of Peace, United States	22, XVII
Inter-American Foundation	5, LXIII; 22, X
Interior Department	
American Indians, Office of the Special Trustee	25, VII
Bureau of Ocean Energy Management, Regulation, and Enforcement	30, II
Endangered Species Committee	50, IV
Federal Acquisition Regulation	48, 14
Federal Property Management Regulations System	41, 114
Fish and Wildlife Service, United States	50, I, IV
Geological Survey	30, IV
Indian Affairs, Bureau of	25, I, V
Indian Affairs, Office of the Assistant Secretary	25, VI
Indian Arts and Crafts Board	25, II
Land Management, Bureau of	43, II
National Indian Gaming Commission	25, III
National Park Service	36, I
Natural Resource Revenue, Office of	30, XII
Reclamation, Bureau of	43, I
Secretary of the Interior, Office of	2, XIV; 43, Subtitle A
Surface Mining Reclamation and Enforcement, Office of	30, VII
Internal Revenue Service	26, I
International Boundary and Water Commission, United States and Mexico, United States Section	22, XI
International Development, United States Agency for Federal Acquisition Regulation	22, II 48, 7
International Development Cooperation Agency, United States	22, XII
International Fishing and Related Activities	50, III
International Joint Commission, United States and Canada	22, IV
International Organizations Employees Loyalty Board	5, V
International Trade Administration	15, III; 19, III
International Trade Commission, United States	19, II
Interstate Commerce Commission	5, XL
Investment Security, Office of	31, VIII
James Madison Memorial Fellowship Foundation	45, XXIV
Japan–United States Friendship Commission	22, XVI
Joint Board for the Enrollment of Actuaries	20, VIII
Justice Department	2, XXVII; 5, XXVIII; 28, I, XI; 40, IV
Alcohol, Tobacco, Firearms, and Explosives, Bureau of	27, II
Drug Enforcement Administration	21, II
Federal Acquisition Regulation	48, 28
Federal Claims Collection Standards	31, IX
Federal Prison Industries, Inc.	28, III
Foreign Claims Settlement Commission of the United States	45, V
Immigration Review, Executive Office for	8, V
Offices of Independent Counsel	28, VI
Prisons, Bureau of	28, V
Property Management Regulations	41, 128
Labor Department	5, XLII
Employee Benefits Security Administration	29, XXV
Employees' Compensation Appeals Board	20, IV
Employment and Training Administration	20, V

Agency	CFR Title, Subtitle or Chapter
Employment Standards Administration	20, VI
Federal Acquisition Regulation	48, 29
Federal Contract Compliance Programs, Office of	41, 60
Federal Procurement Regulations System	41, 50
Labor-Management Standards, Office of	29, II, IV
Mine Safety and Health Administration	30, I
Occupational Safety and Health Administration	29, XXVII
Office of Workers' Compensation Programs	20, VII
Public Contracts	41, 50
Secretary of Labor, Office of	29, Subtitle A
Veterans' Employment and Training Service, Office of the Assistant Secretary for	41, 61; 20, IX
Wage and Hour Division	29, V
Workers' Compensation Programs, Office of	20, I
Labor-Management Standards, Office of	29, II, IV
Land Management, Bureau of	43, II
Legal Services Corporation	45, XVI
Library of Congress	36, VII
Copyright Office	37, II
Copyright Royalty Board	37, III
Local Television Loan Guarantee Board	7, XX
Management and Budget, Office of	5, III, LXXXVII; 14, VI; 48, 99
Marine Mammal Commission	50, V
Maritime Administration	46, II
Merit Systems Protection Board	5, II, LXIV
Micronesian Status Negotiations, Office for	32, XXXVII
Millennium Challenge Corporation	22, XIII
Mine Safety and Health Administration	30, I
Minority Business Development Agency	15, XIV
Miscellaneous Agencies	1, IV
Monetary Offices	31, I
Morris K. Udall Scholarship and Excellence in National Environmental Policy Foundation	36, XVI
Museum and Library Services, Institute of	2, XXXI
National Aeronautics and Space Administration	2, XVIII; 5, LIX; 14, V
Federal Acquisition Regulation	48, 18
National Agricultural Library	7, XLI
National Agricultural Statistics Service	7, XXXVI
National and Community Service, Corporation for	45, XII, XXV
National Archives and Records Administration	2, XXVI; 5, LXVI; 36, XII
Information Security Oversight Office	32, XX
National Capital Planning Commission	1, IV
National Commission for Employment Policy	1, IV
National Commission on Libraries and Information Science	45, XVII
National Council on Disability	34, XII
National Counterintelligence Center	32, XVIII
National Credit Union Administration	12, VII
National Crime Prevention and Privacy Compact Council	28, IX
National Drug Control Policy, Office of	21, III
National Endowment for the Arts	2, XXXII
National Endowment for the Humanities	2, XXXIII
National Foundation on the Arts and the Humanities	45, XI
National Highway Traffic Safety Administration	23, II, III; 47, VI; 49, V
National Imagery and Mapping Agency	32, I
National Indian Gaming Commission	25, III
National Institute for Literacy	34, XI
National Institute of Food and Agriculture	7, XXXIV
National Institute of Standards and Technology	15, II
National Intelligence, Office of Director of	32, XVII
National Labor Relations Board	5, LXI; 29, I
National Marine Fisheries Service	50, II, IV
National Mediation Board	29, X
National Oceanic and Atmospheric Administration	15, IX; 50, II, III, IV, VI
National Park Service	36, I
National Railroad Adjustment Board	29, III

Agency	CFR Title, Subtitle or Chapter
National Railroad Passenger Corporation (AMTRAK)	49, VII
National Science Foundation	2, XXV; 5, XLIII; 45, VI
Federal Acquisition Regulation	48, 25
National Security Council	32, XXI
National Security Council and Office of Science and Technology Policy	47, II
National Telecommunications and Information Administration	15, XXIII; 47, III, IV
National Transportation Safety Board	49, VIII
Natural Resources Conservation Service	7, VI
Natural Resource Revenue, Office of	30, XII
Navajo and Hopi Indian Relocation, Office of	25, IV
Navy Department	32, VI
Federal Acquisition Regulation	48, 52
Neighborhood Reinvestment Corporation	24, XXV
Northeast Interstate Low-Level Radioactive Waste Commission	10, XXVIII
Nuclear Regulatory Commission	2, XX; 5, XLVIII; 10, I
Federal Acquisition Regulation	48, 20
Occupational Safety and Health Administration	29, XVII
Occupational Safety and Health Review Commission	29, XX
Offices of Independent Counsel	28, VI
Office of Workers' Compensation Programs	20, VII
Oklahoma City National Memorial Trust	36, XV
Operations Office	7, XXVIII
Overseas Private Investment Corporation	5, XXXIII; 22, VII
Patent and Trademark Office, United States	37, I
Payment From a Non-Federal Source for Travel Expenses	41, 304
Payment of Expenses Connected With the Death of Certain Employees	41, 303
Peace Corps	22, III
Pennsylvania Avenue Development Corporation	36, IX
Pension Benefit Guaranty Corporation	29, XL
Personnel Management, Office of	5, I, XXXV; 45, VIII
Human Resources Management and Labor Relations Systems, Department of Defense	5, XCIX
Human Resources Management and Labor Relations Systems, Department of Homeland Security	5, XCVII
Federal Acquisition Regulation	48, 17
Federal Employees Group Life Insurance Federal Acquisition Regulation	48, 21
Federal Employees Health Benefits Acquisition Regulation	48, 16
Pipeline and Hazardous Materials Safety Administration	49, I
Postal Regulatory Commission	5, XLVI; 39, III
Postal Service, United States	5, LX; 39, I
Postsecondary Education, Office of	34, VI
President's Commission on White House Fellowships	1, IV
Presidential Documents	3
Presidio Trust	36, X
Prisons, Bureau of	28, V
Procurement and Property Management, Office of	7, XXXII
Productivity, Technology and Innovation, Assistant Secretary	37, IV
Public Contracts, Department of Labor	41, 50
Public and Indian Housing, Office of Assistant Secretary for	24, IX
Public Health Service	42, I
Railroad Retirement Board	20, II
Reclamation, Bureau of	43, I
Recovery Accountability and Transparency Board	4, II
Refugee Resettlement, Office of	45, IV
Relocation Allowances	41, 302
Research and Innovative Technology Administration	49, XI
Rural Business-Cooperative Service	7, XVIII, XLII, L
Rural Development Administration	7, XLII
Rural Housing Service	7, XVIII, XXXV, L
Rural Telephone Bank	7, XVI
Rural Utilities Service	7, XVII, XVIII, XLII, L

Agency	CFR Title, Subtitle or Chapter
Saint Lawrence Seaway Development Corporation	33, IV
Science and Technology Policy, Office of	32, XXIV
Science and Technology Policy, Office of, and National Security Council	47, II
Secret Service	31, IV
Securities and Exchange Commission	5, XXXIV; 17, II
Selective Service System	32, XVI
Small Business Administration	2, XXVII; 13, I
Smithsonian Institution	36, V
Social Security Administration	2, XXIII; 20, III; 48, 23
Soldiers' and Airmen's Home, United States	5, XI
Special Counsel, Office of	5, VIII
Special Education and Rehabilitative Services, Office of	34, III
Special Inspector General for Iraq Reconstruction	5, LXXXVII
State Department	2, VI; 22, I; 28, XI
Federal Acquisition Regulation	48, 6
Surface Mining Reclamation and Enforcement, Office of	30, VII
Surface Transportation Board	49, X
Susquehanna River Basin Commission	18, VIII
Technology Administration	15, XI
Technology Policy, Assistant Secretary for	37, IV
Technology, Under Secretary for	37, V
Tennessee Valley Authority	5, LXIX; 18, XIII
Thrift Supervision Office, Department of the Treasury	12, V
Trade Representative, United States, Office of	15, XX
Transportation, Department of	2, XII; 5, L
Commercial Space Transportation	14, III
Contract Appeals, Board of	48, 63
Emergency Management and Assistance	44, IV
Federal Acquisition Regulation	48, 12
Federal Aviation Administration	14, I
Federal Highway Administration	23, I, II
Federal Motor Carrier Safety Administration	49, III
Federal Railroad Administration	49, II
Federal Transit Administration	49, VI
Maritime Administration	46, II
National Highway Traffic Safety Administration	23, II, III; 47, IV; 49, V
Pipeline and Hazardous Materials Safety Administration	49, I
Saint Lawrence Seaway Development Corporation	33, IV
Secretary of Transportation, Office of	14, II; 49, Subtitle A
Surface Transportation Board	49, X
Transportation Statistics Bureau	49, XI
Transportation, Office of	7, XXXIII
Transportation Security Administration	49, XII
Transportation Statistics Bureau	49, XI
Travel Allowances, Temporary Duty (TDY)	41, 301
Treasury Department	5, XXI; 12, XV; 17, IV;
Alcohol and Tobacco Tax and Trade Bureau	31, IX
Community Development Financial Institutions Fund	27, I
Comptroller of the Currency	12, XVIII
Customs and Border Protection Bureau	12, I
Engraving and Printing, Bureau of	19, I
Federal Acquisition Regulation	31, VI
Federal Claims Collection Standards	48, 10
Federal Law Enforcement Training Center	31, IX
Financial Crimes Enforcement Network	31, VII
Fiscal Service	31, X
Foreign Assets Control, Office of	31, II
Internal Revenue Service	31, V
Investment Security, Office of	26, I
Monetary Offices	31, VIII
Secret Service	31, I
Secretary of the Treasury, Office of	31, IV
Thrift Supervision, Office of	31, Subtitle A
Truman, Harry S. Scholarship Foundation	12, V
United States and Canada, International Joint Commission	45, XVIII
	22, IV

Agency	CFR Title, Subtitle or Chapter
United States and Mexico, International Boundary and Water Commission, United States Section	22, XI
Utah Reclamation Mitigation and Conservation Commission	43, III
Veterans Affairs Department	2, VIII; 38, I
Federal Acquisition Regulation	48, 8
Veterans' Employment and Training Service, Office of the Assistant Secretary for	41, 61; 20, IX
Vice President of the United States, Office of	32, XXVIII
Vocational and Adult Education, Office of	34, IV
Wage and Hour Division	29, V
Water Resources Council	18, VI
Workers' Compensation Programs, Office of	20, I
World Agricultural Outlook Board	7, XXXVIII

List of CFR Sections Affected

All changes in this volume of the Code of Federal Regulations that were made by documents published in the FEDERAL REGISTER since January 1, 2001, are enumerated in the following list. Entries indicate the nature of the changes effected. Page numbers refer to FEDERAL REGISTER pages. The user should consult the entries for chapters and parts as well as sections for revisions.

For the period before January 1, 2001, see the “List of CFR Sections Affected 1949–1963, 1964–1972, 1973–1985, and 1986–2000” published in 11 separate volumes.

24 CFR	2001	24 CFR—Continued	68 FR
			Page
Chapter XX		Chapter XX—Continued	
3500 Policy statement.....	53052	3500.17 (m)(1) revised; eff. 4-16-03.....	12789
24 CFR	2002	2004	
		(No regulations published)	
Chapter XII		2005	
2002 Authority citation re-		24 CFR	70 FR
vised.....	47216		Page
2002.1 Revised.....	47216	Chapter XII	
2002.3 Revised.....	47217	2004.28 Revised.....	36791
2002.7 revised.....	47217	Chapter XX	
2002.9 Revised.....	47217	3280.4 (b) amended; eff. 5-30-06.....	72042
2002.11 (a) revised.....	47217	3280.103 (b) revised; eff. 5-30-06.....	72042
2002.15 (b) revised.....	47217	3280.202 Amended; eff. 5-30-06.....	72042
2002.17 (a) revised.....	47217	3280.203 (a) introductory text re-	
Chapter XX		vised; eff. 5-30-06.....	72042
3280 Waiver.....	20400	3280.206 Revised; eff. 5-30-06.....	72042
3280.112 Amended; eff. 9-16-02.....	12817	3280.207 (a)(4) introductory text	
3280.202 Amended; eff. 9-16-02.....	12817	revised; eff. 5-30-06.....	72043
(c)(1) introductory text, (2), (3)		3280.303 (g) revised; eff. 5-30-06.....	72043
revised.....	49795	3280.304 (b)(1) revised; eff. 5-30-	
3280.208 Revised; eff. 9-16-02.....	12817	06.....	72043
3282.203 (b)(4) amended; eff. 9-16-		3280.305 (g)(3), (4), (5), (i)(1)(i), (ii),	
02.....	12817	(A), (B) and (C) redesignated as	
3284 Added.....	52835	(g)(4), (5), (6), (j)(1), (2), (i), (ii)	
24 CFR	2003	and (iii); (c)(1)(iii), (3)(i)(A),	
		(B), (C), (iv) and new (g)(3)	
Chapter XII		added; (e) and new (j)(1) re-	
2004 Revised.....	3366	vised; eff. 5-30-06.....	72043
Chapter XX		3280.306 (b)(1) revised; eff. 5-30-	
3282.10 Revised; eff. 4-16-03.....	12788	06.....	72045
		3280.401 (a) and (b) revised; eff. 5-	
		30-06.....	72045

24 CFR (4-1-11 Edition)

24 CFR—Continued

	70 FR Page
Chapter XX—Continued	
3280.403 (b), (d)(2) and (e) revised; eff. 5-30-06	72046
3280.404 (b) revised; eff. 5-30-06	72046
3280.405 (b), (c) and (e) revised; eff. 5-30-06	72046
3280.406 (b) introductory text revised; eff. 5-30-06	72046
3280.504 (a)(1) and (b) revised; eff. 5-30-06	72046
3280.508 (a), (b) and (e) revised; eff. 5-30-06	72047
3280.510 (d) added; eff. 5-30-06	72048
3280.604 (b)(2) and table revised; eff. 5-30-06	72048
3280.607 (b)(2)(iii), (iv) and (v) redesignated as (b)(2)(iv), (v) and (vi); (a)(6) and new (b)(2)(iii) added; (c)(6)(iv) revised; eff. 5-30-06	72049
3280.703 Table revised; eff. 5-30-06	72049
3280.704 (b)(5)(i) revised; eff. 5-30-06	72050
3280.705 (b)(3), (4), (c)(2), (1)(1), (2)(ii) and (iii) revised; eff. 5-30-06	72050
3280.706 (b)(3) revised; eff. 5-30-06	72050
3280.707 (f) revised; eff. 5-30-06	72050
3280.709 (h) added; eff. 5-30-06	72050
3280.714 (a)(2) revised; eff. 5-30-06	72051
3280.715 (c), (e) introductory text and (1) revised; eff. 5-30-06	72051
3280.801 (a) and (b) revised; eff. 5-30-06	72051
3280.803 (g) illustration/caption redesignated as (f) illustration/caption; new (f) illustration/caption, (k)(1), (k)(3) introductory text, (ii) and (iii) revised; eff. 5-30-06	72051
3280.804 (a) revised; (k) amended; eff. 5-30-06	72051
3280.805 (a)(3)(iv) revised; eff. 5-30-06	72051
3280.806 (a)(2) and (d)(9) revised; eff. 5-30-06	72052
3280.807 (c) revised; eff. 5-30-06	72052
3280.808 (a), (m), (o) and (q) revised; (r) removed; (s) redesignated as new (r); eff. 5-30-06	72052
3280.811 (b) introductory text revised; eff. 5-30-06	72052

24 CFR

	71 FR Page
Chapter XX	
3280.305 (c)(3)(i)(B) table correctly amended	19638
3280.504 (b)(5) correctly revised	19639
3280.607 (c)(6)(iv) correctly amended	19639
3280.801 (a) correctly revised; (b) correctly amended	19639

24 CFR

	70 FR Page
Chapter XX	
3280.2 Amended	27228
3280.302 Amended; eff. 10-20-08	59361
3280.306 (b)(2)(iii) and (iv) revised; eff. 10-20-08	59362
3282 Authority citation revised	27228
3282.10 Revised	5589
3282.151 (d) revised	73497
3282.207 (e) redesignated as (f); new (e) added; new (f) amended	27228
3285 Added; eff. 10-20-08	59362
3285.702 Figure A corrected	62308
3288 Added	27229
3500.17 (m)(1) revised	5589
3500.19 (a) revised	73497

24 CFR

	73 FR Page
Chapter XX	
3286 Added	35292
3500.1 Revised	68239
3500.2 (b) amended	68239
3500.7 (a) through (e) revised; (f) redesignated as (h); new (f), (g) and (i) added	68240
3500.8 Revised	68241
3500.9 (a)(1) revised	68242
3500.17 (b) amended; (d)(2) and (e)(3) removed; (d) introductory text and (1) redesignated as new (d)(1) and (2); (c) heading, (4) through (8) and new (d)(1) and (2) introductory text revised; (d) heading added	68242
3500.21 (b) and (c) revised	68242
3500.22 Added	68242
3500.23 Added	68243
3500 Appendix A revised	68243
Appendix C revised	68253

List of CFR Sections Affected

24 CFR—Continued 73 FR
Page

Chapter XX—Continued
 Appendix E amended; Appendix MS-1 revised68259

Chapter XXIV
 Chapter XXIV Established 58420
 4001 Added..... 58420

2009

24 CFR 74 FR
Page

Chapter XX
 3500.1 (b)(1) corrected 2370
 (b)(1) revised10174, 22826
 3500.2 Regulation at 73 FR 68239
 eff. date delayed to 4-16-09 2369
 Regulation at 73 FR 68239 eff.
 date further delayed to 7-16-
 200910172
 Amended22826
 3500.17 (n)(3) introductory text
 and (4)(i) amended; (n)(3)(vi)
 and (6)(ii) revised..... 4636

Chapter XXIV
 4000 Added; interim 7813
 4001.07 Amended; interim 621
 4001.102 (a) amended; interim 621
 4001.106 Revised; interim 621
 4001.108 (a) revised; interim..... 621
 4001.110 (a) and (b) revised; in-
 terim..... 621

24 CFR—Continued 74 FR
Page

Chapter XXIV—Continued
 4001.116 (d) and (e) revised; in-
 terim..... 621
 4001.118 (a)(1) revised; interim..... 622
 4001.120 Heading, (a)(1) and (c)(2)
 revised; (e) added; interim..... 622
 4001 Appendix A revised; in-
 terim..... 622

2010

24 CFR 75 FR
Page

Chapter XX
 3280 Policy statement 5888
 3282 Policy statement 5888
 3500 Interpretation..... 36271
 Response to comments74620

2011

(Regulations published from January 1,
 2011, through April 1, 2011)

24 CFR 76 FR
Page

Chapter XV
 Chapter XV Established; eff. 4-4-
 11..... 11950
 2700 Added; eff. 4-4-11 11950

