

A11100 993130

NAT'L INST OF STANDARDS & TECH R.I.C.



A11100993130

/NBS building science series
TA435 .U58 V106,1977 C.1 NBS-PUB-C 1974

REFERENCE

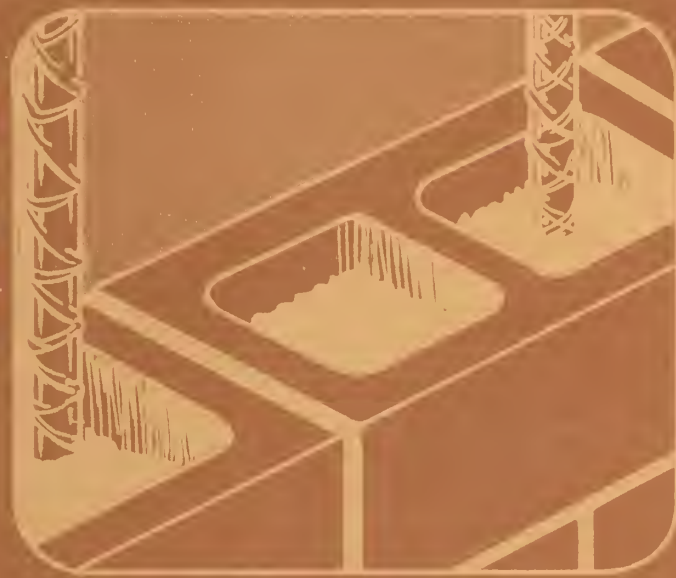
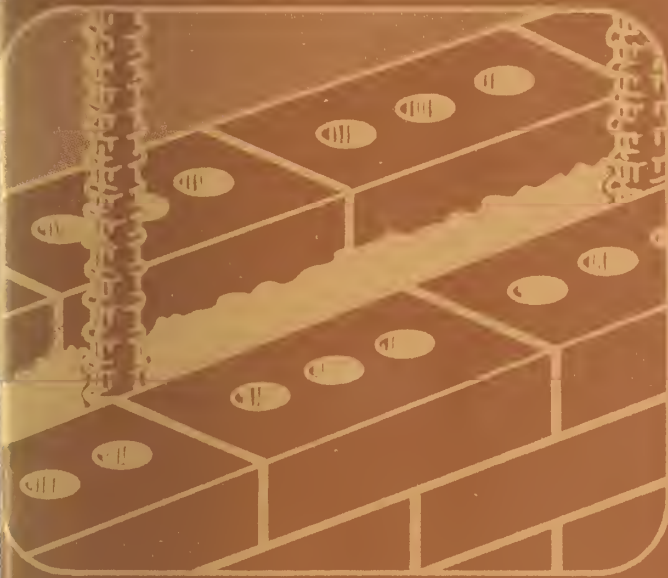

NBS BUILDING SCIENCE SERIES 106

Earthquake Resistant Masonry Construction: National Workshop

A
35
58
o 106
977
. 2

NATIONAL SCIENCE FOUNDATION



U.S. DEPARTMENT OF COMMERCE
NATIONAL BUREAU OF STANDARDS



NATIONAL BUREAU OF STANDARDS

The National Bureau of Standards¹ was established by an act of Congress March 3, 1901. The Bureau's overall goal is to strengthen and advance the Nation's science and technology and facilitate their effective application for public benefit. To this end, the Bureau conducts research and provides: (1) a basis for the Nation's physical measurement system, (2) scientific and technological services for industry and government, (3) a technical basis for equity in trade, and (4) technical services to promote public safety. The Bureau consists of the Institute for Basic Standards, the Institute for Materials Research, the Institute for Applied Technology, the Institute for Computer Sciences and Technology, the Office for Information Programs, and the Office of Experimental Technology Incentives Program.

THE INSTITUTE FOR BASIC STANDARDS provides the central basis within the United States of a complete and consistent system of physical measurement; coordinates that system with measurement systems of other nations; and furnishes essential services leading to accurate and uniform physical measurements throughout the Nation's scientific community, industry, and commerce. The Institute consists of the Office of Measurement Services, and the following center and divisions:

Applied Mathematics — Electricity — Mechanics — Heat — Optical Physics — Center for Radiation Research — Laboratory Astrophysics² — Cryogenics² — Electromagnetics² — Time and Frequency².

THE INSTITUTE FOR MATERIALS RESEARCH conducts materials research leading to improved methods of measurement, standards, and data on the properties of well-characterized materials needed by industry, commerce, educational institutions, and Government; provides advisory and research services to other Government agencies; and develops, produces, and distributes standard reference materials. The Institute consists of the Office of Standard Reference Materials, the Office of Air and Water Measurement, and the following divisions:

Analytical Chemistry — Polymers — Metallurgy — Inorganic Materials — Reactor Radiation — Physical Chemistry.

THE INSTITUTE FOR APPLIED TECHNOLOGY provides technical services developing and promoting the use of available technology; cooperates with public and private organizations in developing technological standards, codes, and test methods; and provides technical advice services, and information to Government agencies and the public. The Institute consists of the following divisions and centers:

Standards Application and Analysis — Electronic Technology — Center for Consumer Product Technology: Product Systems Analysis; Product Engineering — Center for Building Technology: Structures, Materials, and Safety; Building Environment; Technical Evaluation and Application — Center for Fire Research: Fire Science; Fire Safety Engineering.

THE INSTITUTE FOR COMPUTER SCIENCES AND TECHNOLOGY conducts research and provides technical services designed to aid Government agencies in improving cost effectiveness in the conduct of their programs through the selection, acquisition, and effective utilization of automatic data processing equipment; and serves as the principal focus within the executive branch for the development of Federal standards for automatic data processing equipment, techniques, and computer languages. The Institute consists of the following divisions:

Computer Services — Systems and Software — Computer Systems Engineering — Information Technology.

THE OFFICE OF EXPERIMENTAL TECHNOLOGY INCENTIVES PROGRAM seeks to affect public policy and process to facilitate technological change in the private sector by examining and experimenting with Government policies and practices in order to identify and remove Government-related barriers and to correct inherent market imperfections that impede the innovation process.

THE OFFICE FOR INFORMATION PROGRAMS promotes optimum dissemination and accessibility of scientific information generated within NBS; promotes the development of the National Standard Reference Data System and a system of information analysis centers dealing with the broader aspects of the National Measurement System; provides appropriate services to ensure that the NBS staff has optimum accessibility to the scientific information of the world. The Office consists of the following organizational units:

Office of Standard Reference Data — Office of Information Activities — Office of Technical Publications — Library — Office of International Standards — Office of International Relations.

¹ Headquarters and Laboratories at Gaithersburg, Maryland, unless otherwise noted; mailing address Washington, D.C. 20234.

² Located at Boulder, Colorado 80302.

JAN 19 1978

NO. 302
TA
435
U58
no 106
1077
C.2

NBS BUILDING SCIENCE SERIES 106

Earthquake Resistant Masonry Construction: National Workshop

Proceedings of a National Workshop
held at the National Bureau of Standards,
Boulder, Colorado, September 13-16, 1976

Edited by:

Robert A. Crist
Louis E. Cattaneo

Center for Building Technology
Institute for Applied Technology
National Bureau of Standards
Washington, D.C. 20234

Sponsored by:

The National Science Foundation
Washington, D.C. 20550



U.S. DEPARTMENT OF COMMERCE, Juanita M. Kreps, Secretary
Dr. Sidney Harman, Under Secretary
Jordan J. Baruch, Assistant Secretary for Science and Technology
NATIONAL BUREAU OF STANDARDS, Ernest Ambler, Acting Director

Issued September 1977

Library of Congress Catalog Card Number: 77-600053

National Bureau of Standards Building Science Series 106

Nat. Bur. Stand. (U.S.), Bldg. Sci. Ser. 106, 372 pages (Sept. 1977)

CODEN: BSSNBV

U.S. GOVERNMENT PRINTING OFFICE
WASHINGTON: 1977

For sale by the Superintendent of Documents, U.S. Government Printing Office, Washington, D.C. 20402
Price \$6

Stock No. 003-003-01872-4

PREFACE

Research on earthquake resistant masonry construction is currently in progress on an international level. Federal research laboratories and various universities in the United States, as well as their counterparts in foreign countries are conducting research which collectively covers the many diverse areas of technical problems in masonry construction. Because the studies are spread worldwide and masonry design criteria are still deficient, there is a need to:

1. Review the deficiencies and establish priorities for future research.
2. Assess, by professional consensus, the accomplishments of masonry research as it applies to the development of improved or new design criteria.
3. Assess, by professional consensus, the accomplishments and scopes of the various research projects and provide researchers with a critical review of their accomplishments and plans.
4. Initiate a continuing liaison between the various research laboratories and other professional groups concerned with masonry construction.

To accomplish this, a National Workshop on Earthquake Resistant Masonry Construction was held at the National Bureau of Standards (NBS) facility in Boulder, Colorado from September 13 through September 16, 1976. It was conducted by the Center for Building Technology (CBT) of the National Bureau of Standards and was sponsored by the National Science Foundation (NSF).

The workshop was conducted on a basis of participation by invitation and consisted of two parts. In the first, researchers who have been recognized contributors to masonry research reported their achievements and future plans; also included were reports from invited users of masonry design criteria (designers, code officials, regulatory officials, etc.), representatives from the NBS and other

Federal Agencies. The second part involved the development of recommendations by the participants arranged into working groups. Each of the five working groups was assigned the task of producing a critical review of the research projects presented in the first part, and a set of recommendations, relating to one of five designated problem areas in need of research. These were (1) Code Requirements (2) Design Criteria (3) Mathematical Models (4) Test Standardization and Material Properties and (5) Retrofit and Repair.

The number of attendees provided the best potential for obtaining a broad spectrum of opinions, but at the same time producing the intended objectives by the close of the workshop.

These proceedings are published with the intent that they can assist in assuring that future Federally funded research projects for earthquake resistant masonry construction are oriented toward national needs in current problem areas related to design criteria.

CONTENTS

	<u>Page</u>
Preface	iii
SI Units Conversion Table	vi
Abstract	vii
Agenda of Workshop	viii
Introduction	1
1. Presentations and Discussions	7
2. Recommendations of Workshop	327
List of Participants	360

SI CONVERSION UNITS

In view of the present accepted practice in this country for building technology, common U.S. units of measurement have been used throughout this publication. In recognition of the position of the United States as a signatory to the General Conference on-Weights and Measures, which gave official status to the metric SI system of units in 1960, appropriate conversion factors have been provided in the table below. The reader interested in making further use of the coherent system of SI units is referred to: NBS SP 330, 1974 Edition, "The International System of Units" and ASTM E380-76, Standard for Metric Practice.

	<u>Customary Unit</u>	<u>International (SI) Unit</u>	<u>Conversion</u>
<u>Length</u>	inch (in)	meter (m)*	1 in=0.0254 m**
	foot (ft)	meter (m)	1 ft=0.3048 m**
<u>Area</u>	inch ² (in ²)	meter ² (m ²)	1 in ² =6.4516 x 10 ⁻⁴ m ² **
	foot ² (ft ²)	meter ² (m ²)	1 ft ² =9.290 x 10 ⁻² m ²
<u>Volume</u>	inch ³ (in ³)	meter ³ (m ³)	1 in ³ =1.639 x 10 ⁻⁵ m ³
	foot ³ (ft ³)	meter ³ (m ³)	1 ft ³ =2.832 x 10 ⁻² m ³
<u>Force</u>	pound (lbf)	newton (N)	1 lbf=4.448 N
<u>Pressure</u> or <u>Stress</u>	pound per square inch (psi);	newton/meter ² (N/m ²)	1 psi=6895 N/m ²
	kip per square inch (ksi)	newton/meter ² (N/m ²)	1 ksi=6895 x 10 ³ N/m ²
<u>Energy</u>	inch-pound (in-lbf)	joule (J)	1 in-lbf=0.1130 J
	foot-pound (ft-lbf)	joule (J)	1 ft-lbf=1.356 J
<u>Torque</u> or <u>Bending</u> <u>Moment</u>	pound-inch (lbf-in)	newton-meter(N-m)	1 lbf-in=0.1130 N-m
	pound-foot (lbf-ft)	newton-meter(N-m)	1 lbf-ft=1.356 N-m
<u>Mass</u>	pound (lb)	kilogram (kg)	1 lb=0.4536 kg
<u>Density</u>	pound per cubic foot (pcf)	kilogram/meter ³ (kg/m ³)	1 pcf=16.02 kg/m ³
<u>Velocity</u>	foot per second (ft/sec)	meter/second (m/s)	1 ft/sec=0.3048 m/s
<u>Acceleration</u>	foot/second/second (ft/sec ²)	meter/second/second (m/s ²)	1 ft/sec ² =0.3048 m/s ²

*Meter may be subdivided. A centimeter (cm) is 1/100 m and a millimeter (mm) is 1/1000 m.

**Exact value; others are rounded to four digits.

ABSTRACT

The National Workshop on Earthquake Resistant Masonry Construction provided an exchange of information between researchers and practicing engineers for the purpose of orienting pertinent research toward national needs concerning current problems related to design criteria. These proceedings contain the reports presented by researchers and by users of design criteria, as well as transcripts of the discussions which followed the individual presentations. In addition, the proceedings include recommendations which emanated from working sessions held by five working groups of participants. Technical areas covered by the groups were (1) code requirements, (2) design criteria, (3) mathematical models, (4) test standardization and material properties, and (5) retrofit and repair. The recommendations were derived to identify research which would lead to improved output in each of the technical areas in order to benefit national needs.

Keywords: Building codes and standards; design criteria; earthquake resistance; masonry construction; seismic design; structural design; structural engineering; structural research.

AGENDA

Earthquake Resistant Masonry Construction
National Workshop
Boulder, Colorado
September 13-16, 1976

Page
No.

Monday Morning

- 1 Introduction - John B. Scalzi, Program Manager, Earthquake Engineering
National Science Foundation
- 3 Charles Culver, Program Manager, Disaster Mitigation
National Bureau of Standards
- 9 A Perspective View - Brick Masonry Construction in the U.S.A.
Alan H. Yorkdale, Director, Engineering and Research
Brick Institute of America
- 17 A Perspective View - Concrete Masonry Construction in the U.S.A.
Thomas B. Redmond, Director of Technical Services
National Concrete Masonry Association
- 40 A Perspective View - Scope of Needed Research in Earthquake Resistant
Masonry Construction
Robert A. Crist, Chief, Structures Section
National Bureau of Standards
- 49 Discussion

Monday Afternoon

Research Presentations

- Session Chairman - John B. Scalzi
National Science Foundation
- 60 Seismic Research on Masonry
University of California, Berkeley 1972-1977
and
- 91 Expected Performance of Uniform Building Code-Designed
Masonry Buildings
Ronald Mayes, Professor, Department of Civil
Engineering, University of California
- 110 Discussion
- 114 An Experimental Study of Concrete Masonry Under
Seismic-Type Loading
G.A. Hegemier, Professor, Department of Applied
Mechanics, University of California
and
G. Krishnamoorthy, Professor, Department of Civil
Engineering, San Diego State University
- 154 An Experimental Study of Connections in Reinforced
Concrete Masonry Structures Under Seismic Loading
Jeremy Isenberg, Associate, Weidlinger Associates
- 166 Masonry Research and Codes in the United Kingdom
William B. Cranston, Deputy Head, Design Department
Cement and Concrete Association, United Kingdom

The Capacity of Unreinforced Masonry Shear Walls Under
Membrane Loads

S. George Fattal, Structural Research Engineer
National Bureau of Standards

Monday Evening - Workshop Dinner

Tuesday Morning

Presentations on Users Activities and Needs

Session Chairman - Edgar V. Leyendecker, Structural Research Engineer
National Bureau of Standards

- 198 Canadian Code Requirements for Masonry in Earthquake
Zones
A.H.P. Maurenbrecher, Division of Building Research
National Research Council, Canada
- 210 Discussion Air Force Building Construction Experiences in
Relationship to Masonry Seismic Design
(Oral Presentation Only)
Robert P. Reid, Civil Engineer
United States Air Force
- 213 Discussion HEW Activity in Masonry Design and Construction
215 Ross M. Webb, Structural Consultant
Department of Health, Education, and Welfare
- 218 Discussion U.S. Army Corps of Engineers Requirements for Seismic
Design of Masonry
(Oral Presentation Only)
John M. Lybas, Structural Engineer
U.S. Army Construction Engineering Research Laboratory
- 220 NAVFAC Interests in Earthquake Resistant Masonry
Construction
Joe V. Tyrrell, Director, Civil-Structural Division
Naval Facilities Engineering Command
Department of the Navy
- 221 Summary of the Veterans Administration Earthquake
Engineering Program
Patrick M. Sears, Civil Engineering Service
Veterans Administration
- 225 Discussion Seismic Requirements of the Phoenix Construction Code
228 R.C. Hildebrandt, Assistant Director, Building Safety
Department, City of Phoenix
- 231 Discussion Concerns of the NYC Housing Authority in the Design of
Multifamily Masonry Residential Structures
238 Eric Nadel, Assistant to General Manager for Development
New York City Housing Authority
- 241 Discussion Requirements of a Seismic Resistant Masonry Construction
Code
243 Creighton C. Lederer, Director, City of Detroit
Department of Buildings and Safety Engineering
- 247 Discussion

The Relationship of Model Codes to Seismic Design
(Oral Presentation Only)
Christ T. Sanidas, Chief Building Official
City of Memphis

249 Discussion

Tuesday Afternoon

Presentations on Users Activities and Needs (continued)

Session Chairman - Robert A. Crist, National Bureau of Standards

255 Some Research Needs of Earthquake-Resistant Masonry
James E. Amrhein, Director of Engineering
Masonry Institute of America

259 Suggested Researchable Items Relating to Masonry
Construction
John F. Meehan, Principal Structural Engineer
Office of the State Architect, California

271 Discussion

275 A View on Some Prerequisites for Improved Earthquake
Resistant Masonry Construction
Michael E. Werner, Technical Director
Building Officials and Code Administrators
International, Inc.

283 Arching in Masonry Walls Subjected to Out-of-Plane
Forces
Bernard L. Gabrielsen, Professor, Department of Civil
Engineering and Applied Mechanics
San Jose State University

314 Some Thoughts on Minimum Requirements for the Seismic
Design of Load Bearing Masonry Buildings
Richard M. Gensert, Structural Engineer
Gensert, Peller, Mancini, Associates

319 Discussion

Organization and Assignments of Working Groups

Wednesday

Discussions Within Working Groups

Thursday Morning

Presentations by Working Groups

Thursday Afternoon

Discussions Within Working Groups and Consideration of Overall Group Comments

ADJOURNMENT.

INTRODUCTION TO THE WORKSHOP

John B. Scalzi
Program Manager, Earthquake Engineering
National Science Foundation

Welcome to the workshop on "Earthquake Masonry Construction" to which you have graciously consented to give of your time and experience. The National Science Foundation sincerely appreciates your contribution to this greatly needed activity.

It is a well known fact that masonry is one of the oldest, if not the oldest, construction material known to man. From biblical times - to the present, the construction methods have improved only slightly. The bricks are still placed one upon another with the mortar as the binding agent. Relatively little has been done to research the true behavior of the material, either as a component or as a complete system with connecting devices of various types. Analysis methods have usually been of the approximate type with many basic assumptions to account for the lack of experimental data on the behavior of the material. The principal reason for this approach is the lack of a good understanding of the physical properties of the material, and the systems of construction which do not lend themselves readily to analytical elastic solutions. The material is more or less brittle and the complete range of physical properties is not easily determined by tests.

The time has come because of seismic safety and economy of construction to learn the facts concerning the true behavior of masonry construction. I view this workshop, comprised of experts in the many related areas of masonry construction, to be the springboard for a new era in research on masonry construction systems and methods. Through your efforts the proceedings of this meeting will serve as a source of knowledge, yet to be determined, by current and future researchers. I view the proceedings as a master plan for research activities in masonry in the areas of analysis, connections, mathematical models, elastic and limit behavior, design code provisions, design criteria, standards of materials and tests, and, that very important area of rehabilitation and retrofit of existing buildings.

As the results of this research program are generated and utilized by educators, regulatory agencies, and model code organizations, you will realize the ultimate benefit of your endeavors. These results will be brought to fruition by the safety and economy of masonry construction.

I take this opportunity to thank all of you for your participation and to wish you a most successful workshop.

INTRODUCTION TO THE WORKSHOP

Charles Culver
Program Manager, Disaster Mitigation
National Bureau of Standards

Good morning. On behalf of the National Bureau of Standards, I would like to welcome you to the National Workshop on Earthquake Resistant Masonry Construction.

Earthquakes have been in the news quite a bit lately. Recent destructive earthquakes in Guatemala, China, Italy and the Philippines caused considerable loss of life and reinforced the need to improve the built environment to withstand these natural hazards. The "Palmdale Bulge" in Southern California and earthquake prediction activities have created increased public awareness of the problem. The Congress has taken action; bills were recently introduced in the House and Senate, hearings have been held and Federal legislation appears imminent. The legislation recognizes the national scope of the problem and the important role of earthquake resistant design. This workshop is therefore very timely.

You may ask, "Why devote an entire workshop to one construction material?" There have been many conferences devoted to earthquakes. These ranged from sessions devoted to research, to general discussions of problems associated with earthquakes and earthquake resistant design. They produced numerous recommendations for action. In view of the extensive use of masonry construction in the United States, the numerous research and development efforts devoted to masonry currently underway, and broad-based input required for a coordinated approach to develop earthquake resistant design procedures, the need for this workshop was apparent.

We carefully selected the participants to achieve a balanced viewpoint - six Federal agencies in addition to the National Science Foundation and the National Bureau of Standards are participating (HUD, GSA, HEW, Dept. of Army, Dept. of the Navy, Air Force). The three model codes are represented. State and local building officials from California, Arizona, Missouri, Michigan and Tennessee are here. University researchers working on masonry research with NSF funding are also attending. Hopefully, this will lead to some lively discussion.

Our sponsor, The National Science Foundation, looks to this workshop as a means for establishing a program plan for funding needed research. They anticipate similar workshops. Planning is already underway for a workshop on earthquake resistant design of concrete structures. We see additional benefits from this undertaking. Two of our workshop speakers will provide a perspective view of masonry construction in the U.S. today. The research presentations will summarize ongoing activities. The sessions will also provide a forum for those involved in masonry construction programs and those concerned with building regulations to identify pressing everyday problems. This interchange of ideas in itself should be very helpful.

Perhaps more important, however, the second half of the workshop provides an opportunity for all of us to work together in developing recommendations for the course of future actions in this area. These recommendations, together with the papers presented at the workshop will be published by the National Bureau of Standards. This report will be useful for program planning purposes at the Federal level, for planning new research and for stimulating implementation of improved building practices as they are developed.

It was not by accident that we titled these sessions a "Workshop" rather than a conference. The program was structured to provide considerable time for small working groups to address the problems of code requirements, design criteria, mathematical models, test standardization and material properties, and rehabilitation for masonry construction and develop the recommendations. In order to provide everyone the opportunity to contribute to each topic and to attempt to achieve a consensus on all the topics, general sessions involving all the participants have been scheduled to review the individual committee recommendations prior to publication of the workshop proceedings.

The committees have much to do. Their success depends on your efforts. I was involved in a similar workshop here in Boulder several years ago and the committees worked well beyond midnight to develop their recommendations. I believe the success of that effort was due in large part to this conscientious participation.

We look forward to working with you this week and the opportunity this workshop provides for achieving significant progress in the design and construction of earthquake resistant masonry structures. The session this morning is concerned with an overview of our topic. The two speakers from the masonry industry will provide a perspective on concrete and brick masonry construction in the United States. This will be followed by a presentation dealing with the scope of needed research.



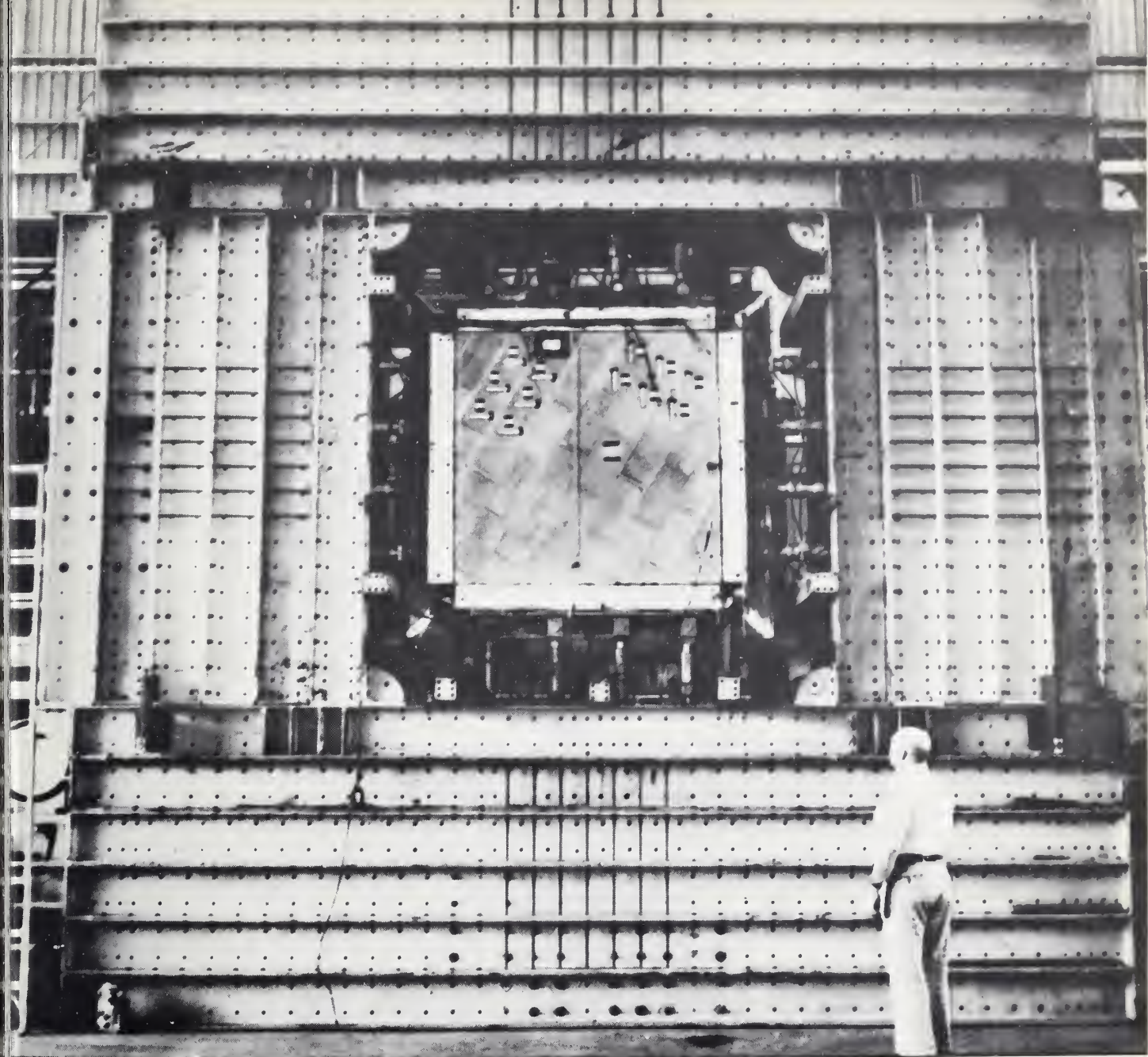

1. PRESENTATIONS AND DISCUSSIONS

A PERSPECTIVE VIEW:
BRICK MASONRY CONSTRUCTION IN THE U.S.A.

Alan H. Yorkdale
Director, Engineering and Research
Brick Institute of America

I. Introduction

First, on behalf of the Brick Industry, let me say how very pleased we are that the NBS and NSF are holding this workshop, I am honored to be asked to participate. I believe we have an opportunity to prepare the road map that will guide masonry research and development for many years to come.

We are looking forward with a great deal of anticipation to the next four days, and also to the document that will result from your participation.

Now, as to my own contribution to this effort. I was assigned the title "A Perspective View of Brick Masonry Construction". I interpreted this to mean "Where Are We Now", so that we can go forward from here. As a consequence, I have gathered considerable data and statistics that have not yet been made into illustrations.

I will therefore only touch on some of the highlights.

II. The Brick Industry

The Brick Industry is rather small by comparison to some others in the building industry. Historically, it is made up primarily of relatively small family-owned operations. This is now changing to fewer, larger and publicly-owned corporations.

For example, in the early thirties, it is reported that there were approximately 1200 brick plants and 1000 companies in the United States. Now there are approximately 400 plants owned by approximately 300 companies.

It is important to note, however, that the capacity has remained very nearly the same, about 12 billion Standard Brick Equivalents per year.

Since 1949, the level of production has risen from about 5.5 billion to approximately 9.0 billion SBE, with the highest year in that span being 1973. The dollar volume of the Brick Industry has ranged, during the same period, from \$129 million in 1949 to about \$451 million in 1973.

Incidentally, of these totals the Brick Institute of America represents approximately one-third of the number of companies, but about two-thirds of the production.

These numbers are of little value, however, until they are related to construction values.

For example, it was estimated by the Arthur D. Little organization, in a 1972 Study of the Brick Industry, that the cost of brick accounted for only about 16 percent of the cost of the construction in 1970. By extrapolation then, brick masonry put in place represented approximately \$1.8 billion.

This is not too far off, as the U.S. Department of Commerce's "1967 Census of the Construction Industry" estimated the total value of all masonry as \$2.142 billion, or more than 5 percent of the total of building construction. The 1972 census figures are out now, but I was not able to get the report in time for this meeting.

So much for the size of the industry.

III. Where is Brick Used?

Again using data from the 1972 Arthur D. Little report, buildings or uses of brick were broken down into (7) seven categories as follows:

1. Commercial Commodity
2. Prestige
3. Institutional
4. Miscellaneous Buildings
5. Single-Family Housing
6. Multi-Family Housing
7. Non-Building (chimneys, fireplaces, paving, etc.)

The distribution of brick use in these categories is as follows:

For the entire United States -

1. Commercial	12%
2. Prestige	1%
3. Institutional	11%
4. Miscellaneous	2%
5. Single-Family Housing	34%
6. Multi-Family Housing	27%
7. Non-Building	13%

A better grouping for our purposes might be:

1. Commercial-Institutional	26%
2. Housing	61%
3. Non-Building	13%

Naturally, these figures vary on a regional basis. For example:

In the New England States, the Commercial-Institutional represents 38%

In the South Atlantic States, the Housing represents 73%

In the Pacific States, the Non-Building represents 60%

It is apparent that the primary structural (loadbearing) use of masonry is in Multi-Family Housing, Hotels, Motels, Dorms., etc. Knowledgeable people estimate that about 30% of this grouping is structural brick masonry, and about half of that is in combination with concrete block masonry.

IV. Masonry Design

As we are all aware, building with masonry dates back into prehistory, according to some, for 10,000 years. Even up to the beginning of this century the "Master Builder Architect" knew intuitively how to "design" with brick masonry. He used rules-of-thumb and empirical methods that were developed from experience over the previous thousands of years. He knew how high, thick, etc., he could build a brick wall.

It should be remembered that we haven't progressed very far from that era. Even our early building codes and so-called "Design Standards" were merely a formalization, or writing-down, of the old rules-of-thumb.

The masonry industry is really quite young in the field of "rational design". The first complete rational design procedure in the United States only dates back to 1966, and it was, and still is, working stress design.

The Design Procedures that are currently in use for masonry are:

1. ANSI A41.1-1953 (R 1972) for all masonry products - unreinforced and totally empirical.
2. ANSI A41.2-1960 (R 1972) for all masonry products - reinforced, partially rational, mostly empirical.
3. UBC Chapter 24-1976, for all masonry materials - reinforced and non-reinforced, some rational but hampered by a great deal of empirical requirements.
4. DoD Tri-Service Manual, for all masonry materials - reinforced and non-reinforced, some rational design but also hampered by a lot of empirical requirements.
5. BIA Design Standard, for brick only - reinforced and non-reinforced, mostly rational but only working stress design.

In addition there are, of course, others that are combinations of the above, and they have their limitations also.

There are other design standards now in the development stages. Among these are:

1. The ATC-3 Document (all masonry)
2. BIA/NCMA (composite masonry)
3. ACI 531 (concrete masonry and composites)
4. BIA (hollow brick)

The problem is few of these address the question of seismic design, except through the use of empirical requirements.

V. Risk Maps

Which leads me to the subject of Risk Maps. I am aware that this is probably not within the purview of this workshop, but if we are to really do any good here, we need Rational Risk Maps.

We would be hard put, as engineers, to explain to an owner about to build a structure that - Charleston, South Carolina is identical to Los Angeles, California, or that Boston is just like San Francisco.

And pity the poor man in Memphis who, by the stroke of a pen, must begin to design his building for an earthquake that, according to some, will not occur again for over a thousand years.

I believe that we should demand more rationale in preparing these so-called "Risk Maps".

VI. Seismic Performance

Because of the problems experienced with unreinforced, lime mortar masonry in the early U.S. earthquakes of 1906 in San Francisco, 1933 in southern California and others, masonry construction received a lot of unfavorable attention in the western part of the U.S. It was primarily due to this experience and performance, plus the lack of forthcoming rational design information, that seismic design of masonry was and is now almost entirely empirical.

Rational design procedures based on structural performance research are a relatively recent development in the masonry industry, with the first U.S. Standard adopted in 1966. Consequently, seismic performance experience is almost non-existent for this type of structural masonry. However, there have been some modern rationally designed brick masonry structures that have experienced seismic events of some magnitude. Failures and damage have occurred primarily where poor construction practices and/or poor design were involved. Where good construction practices and good design procedures were followed, the buildings performed very well. Reports from the two most recent severe seismic events, the Alaska quake and the 1971 San Fernando quake, support these findings.

An example of a brick masonry building that has been subjected to strong seismic actions and activity and has performed quite well is the Veterans Administration Hospital, Sepulveda, California.

Other structural brick masonry buildings built in seismic zones and subjected to somewhat smaller seismic events have also suffered no damage.

Among these are:

1. Park Mayfair East, Denver, Colorado. Architects - Andersons and Looms, AIA; Engineers - Sallada and Hanson. (This building has been subjected to several minor and moderate seismic disturbances in the Denver, Colorado area without suffering so much as cracked plaster.) (Figure 1).
2. Married Student Housing, Montana State University, Bozeman, Montana. Architect - McIver and Hess, AIA; Structural Engineer - Sallada and Hanson.
3. Senior Citizens Apartments, London, Ontario, Canada. Architect - Hagerty, Buist, Breivik and Milics; Structural Engineer - B. A. Hastings.
4. Augustana College Dormitories, Sioux Falls, South Dakota. Architect/Engineers - the Spitznagel Partners, Inc.
5. Library-Classroom Building, Eastern Montana College, Billings, Montana. Architect - Cushing, Terrell and Associates; Engineer - Wilbur J. Bennington.
6. Park Lane Towers, Denver, Colorado. Architect - Joseph T. Wilson Associates, AIA; Structural Engineers - Sallada and Hanson and Associates.
7. Housing for the Elderly, St. Paul, Minnesota. Architect - Brooks Cavin; Structural Engineer - Frank Horner Company.

Under the current building code requirements and design procedures, structural and non-structural masonry in zones two and above are required to be "reinforced".

For the purpose of the code "reinforced masonry" is arbitrarily defined as masonry "... in which reinforcement is embedded as required in such a manner that the two materials shall act together in resisting forces. The minimum area of steel shall be not less than 0.002 times the cross-sectional area of the wall, but with not more than two thirds of the steel to be used in either direction. The maximum spacing of the principal reinforcement in general shall not be more than six times the wall thickness and no more than 48 inches".

Although more advanced analysis techniques, including dynamic structural analysis, are available and applied to other structural materials (steel and

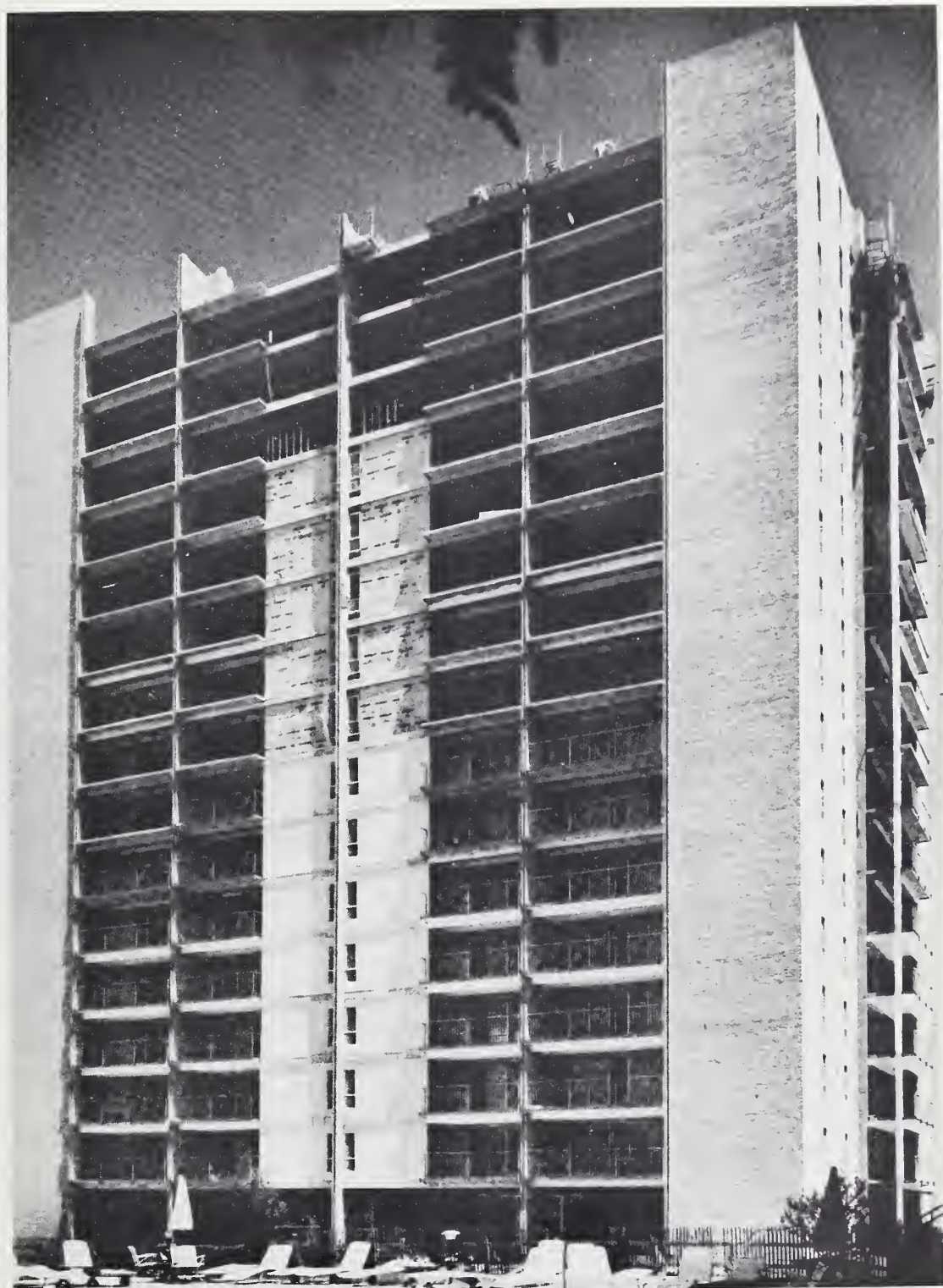

Figure 1 Park Mayfair East Apartments, Denver, Colorado under construction: 17-story, 11-in., reinforced, brick bearing wall, building.

concrete), their application to brick masonry structures has been limited due to the lack of understanding of the behavior of brick masonry structural systems under dynamic excitation.

As previously stated, it is believed by many engineers that the seismic design requirements for masonry now contained in most building codes and standards are quite restrictive and very conservative. Many feel that masonry design technology has not progressed sufficiently to change the requirements. Because of this, masonry design is precluded from the use of most of the newer analysis techniques.

Because of the lack of knowledge, and the need to improve the seismic design requirements for masonry, considerable research is now underway or proposed in this field. Much of this research is sponsored either partially or wholly by the various segments of the masonry industry; materials, labor, and contracting. Some of the research is sponsored by the National Science Foundation, and some is sponsored by various federal government agencies.

As the results of this research are examined and digested by the engineering profession, it is anticipated that the technology for seismic design of masonry will inevitably become more rational in both concept and application.

VII. Conclusion

In conclusion, as I see it, we have a lot to do in these next few days. I look forward to working with you all.

A PERSPECTIVE VIEW:
CONCRETE MASONRY CONSTRUCTION IN THE U.S.A.

Thomas B. Redmond
Director of Technical Services
National Concrete Masonry Association

INTRODUCTION

To obtain a perspective view of Concrete Masonry Construction in the United States, it would be well for us to briefly review the development of the concrete masonry industry, then cover the products and applications of today and then look into the types of products and applications that are expected for the future. Further, recognizing that our purpose this week is to develop a workshop recommendation on the research needed to further develop the structural considerations in our codes, particularly as they relate to earthquake resistance, we should also keep in mind developments which effect the non-structural properties of concrete masonry. If we do not keep in mind the properties of thermal resistance, fire resistance, sound transmission loss and weather resistance, we may end up working on structural research and code development that has no practical value. My purpose then is to provide background on the concrete masonry industry and review product and design considerations that will effect its future growth.

DEVELOPMENT OF THE INDUSTRY

Early attempts at producing a precast building block in America took place in the 19th Century using powdered quick lime and moist sand molded by pressure into a block. The natural heat generated formed a silicate of lime which held the material together. The blocks were solid, oversized, very heavy and exceedingly hard to handle. During the 1800's there followed a series of patents relative to the molding of hollow building block in wooden or iron molds.

The first real advancement came with the development of a hand tamp block machine patented by Harmon S. Parmer in 1900. The machine had removable cores and adjustable sides but still produced a hollow block so large it had to be set with the aid of a hand cranked derrick. Shortly thereafter additional machines were produced with which a three man crew could turn out 200 8x8x24" blocks in a ten hour day. Men from all walks of life rushed into the business which required only 100 dollars in capital investment and a backyard shed. By 1905, 1,500 companies in the U. S. were manufacturing concrete block and selling them at a price very close to what it was in 1970.

However, today the typical investment required is a million dollars but a three man plant crew can produce 15,000 blocks in the same ten hour day.

Concrete block producers were the first to produce lightweight aggregate concrete on a commercial scale. Approval for the use of cinderblock in the borough of the Bronx, New York came in 1900. This was also the start of our 67 year history in recycling of waste

materials. The use of the steam boiler cinders produced a block that was lighter, nailable and which had an improved fire resistance. By 1917 a patent had been issued to cover the manufacture of lightweight aggregates from clay and shale.

During the early period of materials, machine and product development, the industry was loosely organized with a relatively small percentage of the producers belonging to the National Concrete Products Association. The National Concrete Masonry Association was formed in 1929 (formal adoption of the name came in 1934). This came about primarily since the 1928 peak in construction had already started its decline before the 1929 crash. By 1933 construction activity was only 25 percent of the 1928 level. Throughout the depression years, NCMA sponsored comprehensive programs of tests at the Underwriters Laboratories, the National Bureau of Standards, the University of Wisconsin and the University of Illinois. Also during this period the PCA Laboratories fire-tested 215 concrete masonry walls.

During reconstruction, concrete masonry construction grew in terms of volume and quality. By 1941 production reached the then all-time high of 500 million 8x8x16" block equivalents. Machines had become automated and the industry had come of age. Over the 30-year period of 1943 to 1973 the industry grew from a production of 1/2 billion 8x8x16" block equivalents to 3-3/4 billion 8x8x16" block equivalents. Our current recession has resulted in a decline in construction activity and block production, but the figures for the first half of 1976 indicate the start of a new era of increased usage of concrete masonry walls.

THE PRESENT

Many questions have plagued industry during the past few years. High interest rates, air and water pollution regulations, the occupational safety and health laws, and the energy crisis, have been at least partly responsible for the reduction in construction activity. The block industry as many others has begun to learn to accommodate these factors and it would be appropriate to review where we stand now with regard to raw materials, the production process, products and construction applications.

Availability of Raw Materials

There is no shortage of materials necessary for the production of portland cement. The energy requirement is substantial but it is less than half that required for raw steel and glass, 1/12 of that required for plastic resins, and 1/25 that required for primary copper. It requires 7.25 MM BTU per ton (dry process) of product. However, this amount becomes less significant when considering that only 1/10 of this amount goes into the energy cost of concrete masonry. With the use of pozzolans (siliceous and aluminous materials) the amount becomes even less significant.

Sand and gravel and crushed stone, the normal weight aggregates, are produced in a quantity of nearly two billion tons yearly. It is expected that in six to 15 years there will be shortages of sand and gravel in deposits close to metropolitan areas. There is no general shortage anticipated but it is expected that costs of delivery to block plants will increase.

Expanded shale, clay and slate industry did not really begin until after the expiration of original patents in 1946. In 1973

a peak production of twelve million yards was reached but 1976 production is running at about sixty percent of capacity. These aggregate prices increased as a result of the Clean Air Act and were further escalated by the Arab Oil Embargo. The industry has the capacity today of expanding its production without major expenditures and it is expected that costs will stabilize.

Blast furnace slag is not as widely available as natural aggregates but is obtained from any location where the steel industry is currently operating.¹ Molten slag is processed by three methods: Air Cooled slag results when the liquid is allowed to cool gradually in the air.

Expanded Slag is produced when a limited amount of water is injected into a stream of the molten slag and,

Granulated Slag is produced when the molten slag is quenched in large volumes of water.

Expanded slag is ideal for use in concrete masonry units because of its light weight, high fire resistance rating and thermal resistance. With national emphasis on energy conservation and recycling, and with two new techniques for expanding slag, its use is expected to increase.

Vesicular volcanic materials, such as pumice, scoria, breccia and tuff, are used as block aggregates. Of these, pumice is the most prominent and is in abundant supply in the Western United States. Imported pumice (shipped as ballast) has been used in the Eastern U. S. in recent years but its future supply is questionable.

¹States: Alabama, California, Colorado, Illinois, Indiana, Kentucky, Maryland, Michigan, New York, Ohio, Pennsylvania, Texas, Virginia, Utah and West Virginia.

Coal Cinders, like expanded slag, is a by-product material. Both anthracite and bituminous coal produce cinders suitable for concrete. The use of cinders or expanded slag to produce C/M serve the purposes of :

1. Providing a lightweight aggregate with little use of new energy.
2. Producing a good product from an industrial waste material.
3. Providing increased thermal resistance at low cost.

With new interest in coal as a fuel, it is expected that the supply of usable cinders will increase.

Pozzolans are siliceous and aluminous materials that will react with the free lime in portland cement concrete to extend the binder materials. The principle pozzolans for concrete masonry are fly ash and ground pumice and research has shown that the use of these materials to replace a portion of the portland cement normally used in the mix results in equal or greater strengths. In the interest of energy conservation and increased costs, fly ash has grown in usage.

Block Machinery

Most block machines are produced in the United States and in recent years hundreds have been shipped to countries all over the world. It is estimated that there are over 2,000 block machines in the U. S. with an average individual production capacity of about 1,200 8x8x16" equivalent blocks per hour. (New machines produce 1,600 blocks per hour). Most of the block handling operations have been completely automated.

Curing of Concrete Masonry

While concrete does not require elevated temperatures to cure, there is the time-temperature relationship which facilitates rapid production when elevated temperatures are used. During the rapid growth in use of concrete masonry during the forties, fifties and sixties, most plants installed kilns or autoclaves for either atmospheric or high pressure steam curing. With these methods, most of the curing could be accomplished within a six to 24 hour period. The autoclave process also resulted in the formation of a different type binder, (a monocalcium silicate vs. the di-, and tricalcium silicates formed with atmospheric steam or normal curing) which changed some of the physical properties of the block. Since the energy crisis, the number of autoclave plants has decreased from 200 in 1973 to about 150 today. It is believed that the autoclave process will continue to be used in areas where slag and cinder aggregates are available, for the production of concrete brick and very high strength block, and where low cost substitutes for portland cement are available.

Low pressure steam curing, the principal method used by the industry, does not use much energy. The average total amount of energy used for L. P. curing and all other operations (includes distillate fuel oil, natural gas, propane, electricity and gasoline) included in block production and delivery in 1973 was determined to be about 310,000 BTU's per ton of block produced. Since the energy crunch it is estimated that the average is now closer to 250,000 BTU's per ton of block. The advantages of lower curing temperatures (150 vs. 185⁰F.) with the return to the 24-hour curing cycle is being considered by most in the industry. The kilns of the future will probably be held at a temperature range of 120⁰F. to

to 150⁰F so that walls, roof and built-in racks will not be subject to heat loss between cycles. This procedure will require a greater kiln capacity for most plants.

Comparable Energy Use

It is common today to consider the long term availability of building materials, the energy required for production, and the impact on ecology. It has already been noted that there is no foreseeable end to the supply of aggregates, pozzolans and portland cement.

It would be of interest here to estimate the energy consumed in raw material production and delivery to the job of concrete block. For our estimate the following combination of materials is considered:

<u>Ingredient</u>	<u>Weight, lbs.</u>	<u>Million BTU/ton</u>	<u>Ingredient BTU's-Thousand</u>
Portland Cement	160	7.5	600
Pozzolan	40	0.10	2
Aggregate (Natural or by-product)	1700	0.10	85
Water	<u>100</u>	Negligible	<u>0</u>
Total	2000		687.0
Raw Materials/ton		687,000	
Manufacturing and Delivery of Block/ton		<u>250,000</u>	
		937,000	

Assuming an average block weight of 32# for 8x8x16" equivalent,
Then All Energy per Block = 29,281 BTU/Block or 35,400 BTU/sq.ft.
of wall area.

This is much less than the energy required to produce a square foot of wall of glass, gypsum, steel or aluminum.

The ecology benefits are obvious when it is remembered that many millions of blocks are produced each year using by-product wastes such as expanded slag, coal cinders and fly ash.

Today's Products

Products produced today that have been proven for at least the past ten years include the following categories:

Standard 4,6,8, 10 and 12 inch block units with fittings.

Standard 6, 8, 10 and 12 inch block units for reinforced concrete masonry.

Units for veneer, composite and,

Cavity walls such as brick, split block and slump block, (usually higher strength units).

Architectural units produced for single wythe walls and veneers such as scored block, split ribbed, profile, block, fluted block, etc.

High strength (3500 psi net area) and extra high strength (5000 psi or $>$ net area) block for high rise load bearing construction.

Special application units, from high density block for radiation shielding to patio block and screen block.

The vast majority of this product mix is used for non-loadbearing applications or loadbearing applications of three stories or less. However, an ever increasing market potential is for C/M loadbearing structures from four to 50 stories. It is this application of non-reinforced, partially reinforced and reinforced concrete masonry that requires the greatest attention in design. Possible revision of the seismic design map and a recent concern for progressive collapse is expected to lead to an increased use of reinforced and partially reinforced masonry. Consideration of provision for progressive collapse seems less critical since no high rise masonry building has ever failed in this manner and it is very difficult to define the parameters for unusual loading and the expected frequency. Even with this lack of definition, the PCA, BIA, NCMA and masonry designers are working with the Federal Government

to perform pertinent research in order to improve wall-floor connection details and provide design criteria for continuity through alternate loading paths.

The NCMA Creep and Shrinkage Study on High Strength Block Wall Columns loaded to the equivalent of a 50-story building has recently been completed by PCA. This work provides creep data needed to design buildings over 20 stories with confidence. One 50-story building design was sponsored by NCMA and completed as a Master's thesis in association with Fazlur Kahn.

Some of the actual high rise reinforced and unreinforced concrete masonry buildings built over the last ten years are described briefly in the following list:

- A - 9-Story Travelodge, Harbor Island, San Diego, California
8" Reinforced Concrete Masonry Walls
- B - 13-Story Essex House in Ottawa, Ontario (Apt. House)
Non-Reinforced C/M Bearing Walls (23" to 8" Walls)
- C - 14-Story Apartment in Honolulu
Threadline (thin joint) Reinforced Concrete Masonry
Bearing Walls
- D - 16-Story Cabrillo Square Job in Los Angeles, one of
tallest in Earthquake Zone 3
- E - 13-Story Holiday Inn in Jefferson City, Missouri
8" Reinforced L. B. Walls — 1966
- F - A college dormitory in Southern California (Zone 3)
of 8" Reinforced Bearing Walls designed by Allyn
McIntosh
- G - 18-Story Travelodge, Disneyworld, Orlando, Florida
12" Solid, 8" Solid and 8" Hollow L. B. Walls
Threadline Mortar
- H - Two 22-Story apartments in the Pittsburgh area designed by
Richard Gensert.



Figure 1 - Nine-story Travelodge at Harbor Island, San Diego, California.
(8-inch block, reinforced concrete masonry, load-bearing walls)

Panelized Construction

To date, only a few C/M high rise buildings have been built with panelized construction. There was a surge of interest in panels and modular construction elements during the days of Romney's, "operation breakthrough" but this has not developed rapidly. There are perhaps a dozen producers that are plant-fabricating block panels.

Masonry panels may be fabricated on site or off site, with machines or with masons, conventional mortar or special mortar, reinforced or unreinforced, and with special masonry units specifically for prefabrication usage, conventional brick and block or composites of brick and block. The methods can be divided into 5 general categories which are: hand-laying, casting, special equipment, special units and special mortars.

The hand-laying method of prefabrication is achieved in the same manner as conventional in-place masonry, except it is accomplished in an area removed from the final location of the masonry element.

The casting method of fabrication involves the combining of masonry units and grout into a prefabricated element similar to precast concrete. The casting method is performed with the element either in a vertical or horizontal position which often uses automated equipment.

The special equipment used in prefabrication as practiced today varies widely. It ranges from simple hand tools to highly sophisticated automated machinery.

The most recent innovation in manufactured panels involves high strength steel strapping, surface bonding and urethane foam. Blocks are semi-automatically placed in running bond on an 8'x 18' Tilt Table (while horizontal) as they come from the block machine area. The panel is squared up with steel angle stops and heavy steel strapping is

laced through the the dry stacked panel and drawn tight. Pick up rods are inserted from the top and threaded into 2-1/2" x 3-1/2" anchor plates. (Rods are returned to the plant for reuse). Then urethane foam is injected into the cores for insulation. The Tilt Table is then elevated and the panel is picked up and moved to a four-position carousel for spray application of surface bonding.

Prefabricated unit masonry is a relatively recent entrant in the construction picture, it has made its presence known. Prefabricated masonry is not a cure-all nor the ultimate solution to masonry construction. Prefabrication must be recognized for what it is, another method for fully utilizing the many good properties of masonry.

Design Codes & Research

Present design criteria provide a large margin of safety with respect to static vertical loads on loadbearing masonry walls. The margin of safety provided against an increase in moment without an increase in vertical loads is not as conservative.

It has been suggested by Dikkers, Mathey and Yoke1 that wall capacity can be conservatively predicted by the moment magnifier method. It is further suggested that a rational design procedure such as the moment magnifier method, which includes design variables not presently considered, would be feasible and desirable in the interest of both safety and economy.

Some researchers suggest that the two-block prism test produces high values for assumed value of masonry compressive strength. The effect of test machine platen restraint is the primary reason but the negative effect of no end restraint of adjacent masonry for the prism versus actual wall construction is a strength reduction factor. Perhaps the use of fiber or gypsum board for capping should

be studied. The use of Teflon has been investigated, but its expense is too great. Greater prism heights should not be considered as most commercial labs could not conduct the test.

The behavior of mortar joints under combined compression and shear is receiving considerable attention by researchers. Considerable work is being done with diagonal tension tests but mostly with ungrouted or fully grouted masonry, neither of which is representative of most reinforced or partially reinforced concrete masonry.

The diagonal tension type racking test can be analysed up to first cracking and consequently is of interest to the researcher, code writer and designer.

Shear walls constitute the primary structural element in high rise masonry buildings. An understanding of their behavior in all types of floor plans under seismic loading is of prime interest to this conference. A better understanding should lead to a combination of greater economy and safety. If economy of design and construction is not considered, there is not much need to be concerned with safety.

PROBING THE FUTURE

In our thinking of future construction techniques, it may be well to examine some quotes from the Engineering News Record's Centennial Issue, "Probing the Future", which is a forecast of the year 2000 and beyond, only 24 years away.

Quote—"Concrete will continue as a mainstay of construction in the next century and probably increase, proportionately, as wood use declines. There is no lasting shortage of its components in view except possibly of good natural aggregates at some locations."

Quote—(Concrete) "Strengths of over 60,000 psi may be obtained for special purposes and strengths of 20,000 psi may be routinely obtained in production. Tensile strengths of one-half the compressive strength may also be available."

Quote—"An adhesive polymeric mortar that improves structural properties of masonry and reduces costs in relation to masonry bonded with conventional mortars may also be widely used."

Quote—"With refuse incinerators operating at extremely high temperatures, glossy residues similar to fly ash and slag may be produced and put to use in concrete."

Quote—"New reinforcement materials and techniques that are in experimental stages now will be developed for special uses."

Quote—"Available strengths (of steel) today are in the 30,000 to 100,000 psi range, far short of the 300,000 psi range that may be common before the next century. Even at 300,000 psi, steel will have reached only 10% of the theoretical strength of the material, in the neighborhood of 3 million psi."

Most of these predictions do not seem far fetched. A great deal of work has already been done with organic and organic modified mortars. Concrete masonry homes have already been built with block made with glass residue. Steel, glass and other fibers are already being used for applications such as foundation slabs and surface bonded masonry. High steel strengths for special applications are now available. High bond mortar is now being used to some extent.

There is a growing international mood that, "the city has lost its human qualities. It is overcrowded, noisy, and crime-ridden; most important, not enough attention has been paid to human scale and dimensions". For example, this mood has brought about the recent

rebirth of the use of pavers for streets, sidewalks, roads, play areas, and malls in Europe. It is now a potential for an impressive amount of construction in the United States. In the past year about ten U. S. block producers have started to manufacture pavers and the machinery manufacturers report orders for molds from another 20 block plants.

Interlocking paving stones were not new even 2,000 years ago, when the ancient Romans used them to pave their roads. Surviving numerous earthquakes, many of these roads still exist today. It would appear that people all over the world are tired of the vast ribbons of unrelieved concrete and asphalt that dissect their cities. Urban planners are looking for something with more human warmth and scale and masonry walls and masonry pavers are such materials. The pavers are designed as a flexible system but should failure occur in earthquakes, the units can be easily replaced over the repaired road beds.

Structural Design Will Be Affected By Energy Standards

A major consideration that will have greater effect on the design of building envelope walls is thermal transmittance. If hollow block walls are fully grouted they cannot be insulated as economically as if joint reinforcement were used for horizontal steel and vertical steel was extended to its maximum feasible spacing.

Regarding the developing codes on energy, we can only hope that reason and technical accuracy will prevail. Today there are some prescriptive standards which dictate a U-Value of $0.10 \text{ BTU/ft}^2/\text{°F}$. This is an ineffective approach and has no significant bearing on energy conservation. If U-Values must be used in a prescriptive manner, we should learn from the European countries who have

experienced high prices and shortages of fuel long before us. In many of these countries where prescriptive standards are used, they have settled on a U-Value of 1.0 (metric) for masonry which converts to 0.176 in English units. This is a more reasonable and cost effective value for masonry which provides the extra benefits of thermal inertia or capacity insulation. The Italians have related their standards to the real life interaction of resistance and capacity insulation.

The Italian U-Values are related to wall weight (as a measure of heat storage capacity) and when converted to English units are:

<u>Wall Weight</u> <u>lb/cu.ft.</u>	<u>U</u> <u>Value</u>	<u>(Sample)</u> <u>Construction</u> <u>Type</u>
4	0.09	Frame (wood or metal)
10	0.125	
20	0.165	
40	0.22	8-in block
60	0.276	8-in block, reinforced
80 or >	0.286	12-in block, reinforced

Exciting prospects for more realistic methods of computing energy required for heating and cooling are presented in two important papers. Dr. Francisco Arumi, University of Texas, in a paper, "Thermal Inertia in Architectural Walls" has presented a practical method of integrating the effects of thermal inertia and thermal transmittance. The paper points out how walls with low insulating values and high thermal inertia may perform as well as walls with high insulating values and low thermal inertia. The paper was a joint project of ERDA and NCMA. In another paper, "Comfort Range Thermal Storage" by Dr. A. L. Berlad, et al, researched under contract for the U. S. Energy Research and Development Administration, (to be presented at 1976 ASME Annual Meeting), it is pointed out that "Ordinary Masonry or Phase Change

Masonry^(PCM) structures can be space conditioned in the comfort range at substantially lower cost than an equally well insulated frame structure if the masonry or PCM Structure is insulated exterior to its high mass structural elements." Phase Change Masonry are concrete block that have phase change materials incorporated into the block mix. The paper points out that gypsum board cannot be usefully charged for more than a few minutes while masonry can be usefully charged/discharged over a period of hours. Masonry offers the important potential savings to be derived from the use of low cost off-peak electrical energy and the only real hope for reasonable initial cost solar heat systems.

Why talk about thermal when seismic design is the subject? The exterior wall must often serve both structural and shelter functions. It is important to be aware of trends in products and walls in planning future structural research. With that in mind these are trends that should be considered:

- A - Lightweight block are generally more expensive than dense aggregate block and will therefore be used principally on exterior walls where their resistance and capacity insulation can be used most effectively.
- B - Dense aggregate block will be used for separation and corridor walls except where 4-hour rated walls are required.
- C - It will be desirable to insulate cavity walls in the cavity, rather than on the interior, from the standpoint of using thermal inertia to its fullest potential.
- D - New Shapes of Block for single wythe walls developed to accommodate reinforcing and at the same time increase thermal resistance.
- E - For residential construction, new shapes are being developed.

They will accommodate low-cost insulation, accommodate reinforcing, reduce cost of electrical installation, accommodate plumbing, and increase weather resistance.

There is a good possibility that masonry will be reconsidered for more non-loadbearing interior partition walls. Another strong possibility is that even office buildings will be designed with permanent masonry loadbearing division walls. The reasons for this are: (a) Studies have shown that most temporary walls are not moved and, (b) Interior masonry walls provide sufficient thermal storage capacity to permit the use of off-peak power for heating and cooling.

Research Recommendations

With these considerations or restraints in mind, it is recommended that the following areas of structural research be given consideration. Masonry walls are multifunctional building elements capable of sustaining high load, reducing energy consumption, providing fire resistance and low sound transmission.

1. It is important to consider at least three strength levels for the brick, block, mortar, grout and steel in research evaluating the performance of reinforced and partially reinforced masonry.
2. It is important to develop the prism test as a job site check of masonry units and mortar and to determine allowable stresses for designers. Recognition of commercial laboratory capabilities should be considered.
3. It is important to consider new masonry wall systems for structural research.
4. A variety of floor systems should be considered in research work evaluating their interaction with masonry walls.

5. The use of joint reinforcement to satisfy horizontal steel requirements should be studied. Investigation should include the considerations of using joint reinforcing for the non-principal stresses associated with shrinkage cracking and creep.
6. The interaction and compatibility of the block-mortar-grout-rebar composite of reinforced concrete masonry construction. Investigation should cover consideration involving strain compatibility and stress transfer between reinforcing steel, dense-, and lightweight grout and block/mortar entities.
7. The quality control of materials and quality assurance testing to determine allowable stresses for proper engineering designs. It is imperative that the proper testing procedures are adequately performed in accordance with uniform procedures adopted by ASTM.
8. Concerning new systems or methods of construction, for concrete masonry structures, additional research into the areas of surface bonded construction needs in-depth research similar to that maintained in (6.) above. Also, the use of prefabricated panels and the interaction of such panels used as infilling in structural frameworks is quite important. Research has been performed to date relative to infills and frame interaction, but no simplified method for frame design using this additional load resisting capability has been formulated.
9. Additional research is needed on design and construction details to develop continuity between walls and floor and to allow complete structural integrity for both static and dynamic load effects.

10. Damping and ductility coefficients for masonry structures should be researched.
11. Stiffness coefficients and a rational method of computing masonry building periods should be determined and verified with measurements on actual structures.
12. New construction methods for resisting overturning due to seismic loads should be analyzed, such as post-tensioning masonry structures.
13. Additional studies are needed to determine what is reinforced masonry. What is the rationale behind the maximum spacing of 4 ft.?

BIBLIOGRAPHIC REFERENCES

J. Bell and Contributors, "From the Carriage Age to the Space Age," National Concrete Masonry Association (NCMA) 1969, pp. 166.

"Energy Utilization in Concrete Block Plants," Table III-II, Stanford University, 1973.

Shoai, Faramarz, "A High Rise Concrete Masonry Bearing Structure," An Apartment Building, Illinois Institute of Technology, December, 1973, pp. 100

Federal Energy Administration, Office of Industrial Programs, "The Potential for Energy Conservation in Nine Selected Industries," Primary Energy Consumption Data for the Nine U. S. Industries, Volume 3, Cement, Table 3.1.

Toennies, H. and Redmond, T. B., "Siliceous Fines in the Cementing Median of Steam Cured Concrete Masonry," National Concrete Masonry Association (NCMA), 1967.

Yokel, Mathey and Dikkers, "Strength of Masonry Walls Under Compression and Transverse Loads," National Bureau of Standards, BSS No. 34.

Hegemier, G. A., "Mechanics of Reinforced Concrete Masonry: A Literature Survey," University of California, San Diego, September, 1975.

Forum Two, "The Changing Market for Middle-Income City Housing," Federal National Mortgage Association, June 1975.

Arumi, Francisco H., Ph.D, "Thermal Inertia in Architectural Walls," University of Texas, National Concrete Masonry Association (NCMA) 1976.

Berlad, A., Long, H., Salzano, F., Batey, J., "Comfort Range Thermal Storage", State University of New York, Brookhaven National Laboratory.

Davison, Edward K., "Future Availability of Sand and Gravel," National Sand and Gravel Association, National Concrete Masonry Association (NCMA), January 1976.

Martin, Edward, "Future Availability and Costs of Aggregates," Expanded Shale, Clay and Slate Institute, National Concrete Masonry Association (NCMA), January 1976.

Eggleston, H. K., P.E., "Availability/Cost/Characteristics of Blast Furnace Slag," National Slag Association, National Concrete Masonry Association (NCMA), January 1976.

Rieffler, Paul, "Increased Sales of Block Through Panelization," National Concrete Masonry Association (NCMA), 1976.

Giovannani, Franco, "Blocks, Warm or Cold," National Concrete Masonry Association (NCMA) Annual Convention, January 1976.

Engineering News Record, "Probing the Future, McGraw-Hill's Construction Weekly, April 30, 1974.

Engineering Newsletter Number 71, National Concrete Masonry Association (NCMA), Redmond, T. B., July 1974, pp. 4.

Correspondence to Redmond, T. B., National Concrete Masonry Association, (NCMA) from Kuenning, W., Portland Cement Association.

EARTHQUAKE RESISTANT MASONRY CONSTRUCTION:
A PERSPECTIVE VIEW OF NEEDED RESEARCH

Robert A. Crist*
National Bureau of Standards

Abstract

An overview of the areas of research needed for improved engineering design of earthquake resistant masonry construction is given and followed by a presentation of the information in the form of a 3-dimensional matrix model. The elements of the matrix representing areas of research and their coordinate intersections (combinations) are used to develop the structuring of a workshop in which 5 major areas of consideration are shown to emerge. These 5 categories of: design criteria; standardized tests for material properties; mathematical models; rehabilitation and retrofit; and code requirements; together with respective task statements are each described, in order to organize corresponding workshop groups for accomplishment of the tasks. In conclusion, an order of assigning priorities to needed research is established.

Key Words: Building codes and standards; design criteria; earthquake resistance; limit states design; masonry construction; materials testing standardization; mathematical models; rehabilitation; retrofit; seismic design; structural design; structural research.

It is appropriate at this time to provide some background of the creation of this workshop. The National Bureau of Standards has been involved for several years in a cooperative program with the masonry industry, federal agencies, and with its own effort in a modest program but none the less one that has begun to provide technical information to identify needed research. Industry was represented through the trade organizations of the National Concrete Masonry Association, the Brick Institute of America, and the Masonry Institute of America. The government agencies involved were represented through the Tri-Services Committee comprised of delegates from the Office of the Chief of Engineers, the Naval Facilities Engineering Command and Headquarters, United States Air Force. The NBS cooperative program has had primarily two areas of study: the identification of research needs and the resistance of plain masonry to seismic loads. In the research program the effort has been primarily aimed at failure hypotheses (and their experimental verification) for plain masonry construction involving both grouted and ungrouted concrete and clay masonry systems. Also involved in the research portion was a program of standardization of tests for determining material properties of masonry systems. This research will be presented by Dr. Fattal in this workshop.

*Chief of Structures Section, Center for Building Technology, IAT

The workshop, in its format, stems from the identification of research needs by the NBS cooperative program.

The design of structures to resist earthquake loads will have to be considered for almost the entire United States as indicated by the 1976 Uniform Building Code. Even more demonstrative of the seismic risks in the United States is the preliminary seismic map by Algermissen and Perkins (fig. 1). This map is continually going through consensus processes and is considered in one form or another to be a source of information for seismic requirements. Thus it is not hard to conclude that seismic resistance of masonry construction is going to be required to be well defined in the future.

It was, therefore, necessary to identify a planning model that could be used to establish the research needs and thus supply some rationale to the chaos of research requirements that are currently being discussed. The model presented is a first trial and, hopefully, by the end of the workshop this model will have served as a starting point for an improved one resulting in recommendations from the workshop. To visualize this model a three dimensional coordinate system (matrix) was created and represented by the rectangular solid shown in figure 2. Each plane or coordinate axis represents one of the following: construction classification; masonry assemblages; and implementation and application categories. Figure 3 shows the details of the construction classification axis which consists of nine elements contained in three groups: constituent materials, presence of reinforcement, and details defining constituent materials. Figure 4 shows the masonry assemblages axis. The seven items are listed in a priority order stemming from discussions and a consensus emanating from the NBS cooperative program. Again, it is hoped that by this workshop, terminology and prioritization can be further improved to give research guidance. The last axis, implementation and application, contains six items (fig. 5). These are not listed in priority order. However, they are considered to be (at least as a first trial) the major categories to be considered. This workshop was organized to provide three areas of interaction: (1) presentation of technical subjects; (2) discussion of these subjects; (3) formulation of working groups to produce workshop recommendations for research planning. The last item - working groups - was determined from the implementation and application axis of the model. Five working groups were organized for the workshop: design criteria; test standardiz-

ation and material properties; mathematical models; retrofit and repair; and code requirements. These are five of the six categories listed on the implementation axis (fig. 5). A working group on design details has been omitted as it was thought to be inappropriate for this workshop in view of the short time that we have to produce recommendations. Nevertheless, future recommendations must follow in this important area concerning design details (such as effective anchorage and connections) and hopefully will follow as an outgrowth of this workshop's action.

We should pause for a moment to consider some of the data on this model. The matrix model provides only minimum, or average, rather than maximum considerations and, of course, it is not exhaustive. Thus it is not unreasonable to assume that there could be more than 1000 intersections in the matrix model if all variables were considered. This demonstrates the need for a consensus regarding priority of the parameters leading to intersections in the model that can be considered within the time and funding available. It is obvious that we cannot handle the more than 1000 intersections and still arrive at reasonable solutions to our problems in a time which is responsive.

To compound this problem of the multitude of identified intersections in the matrix model, there are also the great number of codes being used to regulate the masonry construction industry. The following questions arise: "Which of these codes are presently usable resources?" "How can new standards feed into the present code system without proliferating the already confusing code situation?" and "What new research needs to be done to fill in the gaps?" These questions should be addressed in the working group deliberations of this workshop.

In order to organize the working groups and give a better understanding of what is intended in the charge given to each working group, they will be described separately.

Working Group 1. Code Requirements

Work Statement - From an assessment of deficiencies in code and standard requirements for earthquake resistant masonry construction, recommend needed research to alleviate these deficiencies. In addition, this committee should recommend revisions of codes and standards that they feel would foster improvement. Another element of this working

group's output should be the assessment of how the results of research are incorporated into codes and standards, and recommendations for improving the process.

This is the largest problem area of all among the working groups, and it is the assimilation point for implementation of all research. Considered here, also, should be coordination of formal masonry committees in the American National Standards Institute, the American Concrete Institute, and the American Society of Civil Engineers.

Working Group 2. Design Criteria

Work Statement - Assimilate and synthesize available information and knowledge to make recommendations for needed research to develop advanced design criteria; for instance, limit states design approaches.

As limit states design begins to dominate us in future codes and standards, we need to evolve into more modern analysis and design approaches. Also, we should be careful, in this area, not to assume that seismic design would control the design of all masonry structures; there are other loads or implied loads that may control. These could be, for example, out-of-plane wind loading or in-plane shear forces created by differential settlement.

Working Group 3. Mathematical Models

Work Statement - Based on the assessment of current and past masonry research, recommend needed research to develop analytical procedures, and models to design simple elements and whole buildings. Also provide recommendations on the use of mathematical models as a research tool and identify the needed research to create simplified analytical models that designers can use without the aid of computers.

Two classes of mathematical models should be considered: simple, accurate models which the designer can apply easily but which are derived from more complex, analytical models and which can be verified by those analytical procedures; and complex models which would necessarily be provided in their entirety for the larger and more elaborate structures.

Working Group 4. Test Standardization and Material Properties

Work Statement - Assess current masonry test procedures. Formulate recommendations for needed research for the development of tests of relatively small specimens to provide information on material properties such as stiffness, shear strength, and splitting strength which are critical in earthquake resistant masonry design. These standardized tests should fulfill a function similar to that of "prism tests" for determining masonry compressive strength and flexural bond strength (ASTM Designation E447 and E518), and should also be capable of: (1) determining the material properties of various types of masonry construction; (2) providing data for the study of the effects of variables such as the strength of masonry units, the initial rate of absorption of brick, and the various mixes of mortar and grout on the constitutive properties of masonry; (3) providing effective construction quality control.

It should be remembered that standardized tests have to be useful to a broad range of people: the contractor, the inspector (compliance official), the designer/engineer, and the materials supplier or manufacturer. The tests should also be designed to allow the timely completion of a structure. Early strength characteristics and corresponding quality control tests need to be considered, as well as variability allowances in quality control.

Working Group 5. Retrofit and Repair

Work Statement - Assess current methods of repairing buildings that have sustained earthquake damage and recommend needed research to develop new methods of restoring such buildings. In addition, make recommendations for methodology of evaluating and retrofitting existing buildings.

This area is especially important for post-disaster repair and for retrofitting of structures in areas where code revisions have made necessary the upgrading of existing structural systems.

As with any planning model we have to remain flexible, seek the highest level of resources, and iterate the model until it and the answers sought become compatible. A format for the workshop has been created under which we can begin operating through the working groups. As discussions proceed and problems emerge, undoubtedly modifications

to these work statements will occur which will produce what is sought from the workshop - a consensus of needed research for improved seismic resistance of masonry construction.

In closing, there is one area that has to be addressed on all coordinate axes of the research needs planning model: "Which problems need immediate response and solution, and which can be permitted long range research?" This implies the need to establish priorities for research programs. Immediate research programs should supply specific answers to expedite the improvement of design, construction and quality control within the period of one to two years. Long range research programs should provide for innovation, new design concepts, and new materials in the period of two to ten years.

In striving for its objectives, the workshop can be instrumental in bringing about an effective, coordinated approach in future research which will be continually responsive to the current pressing needs of improved design for earthquake resistant masonry construction.

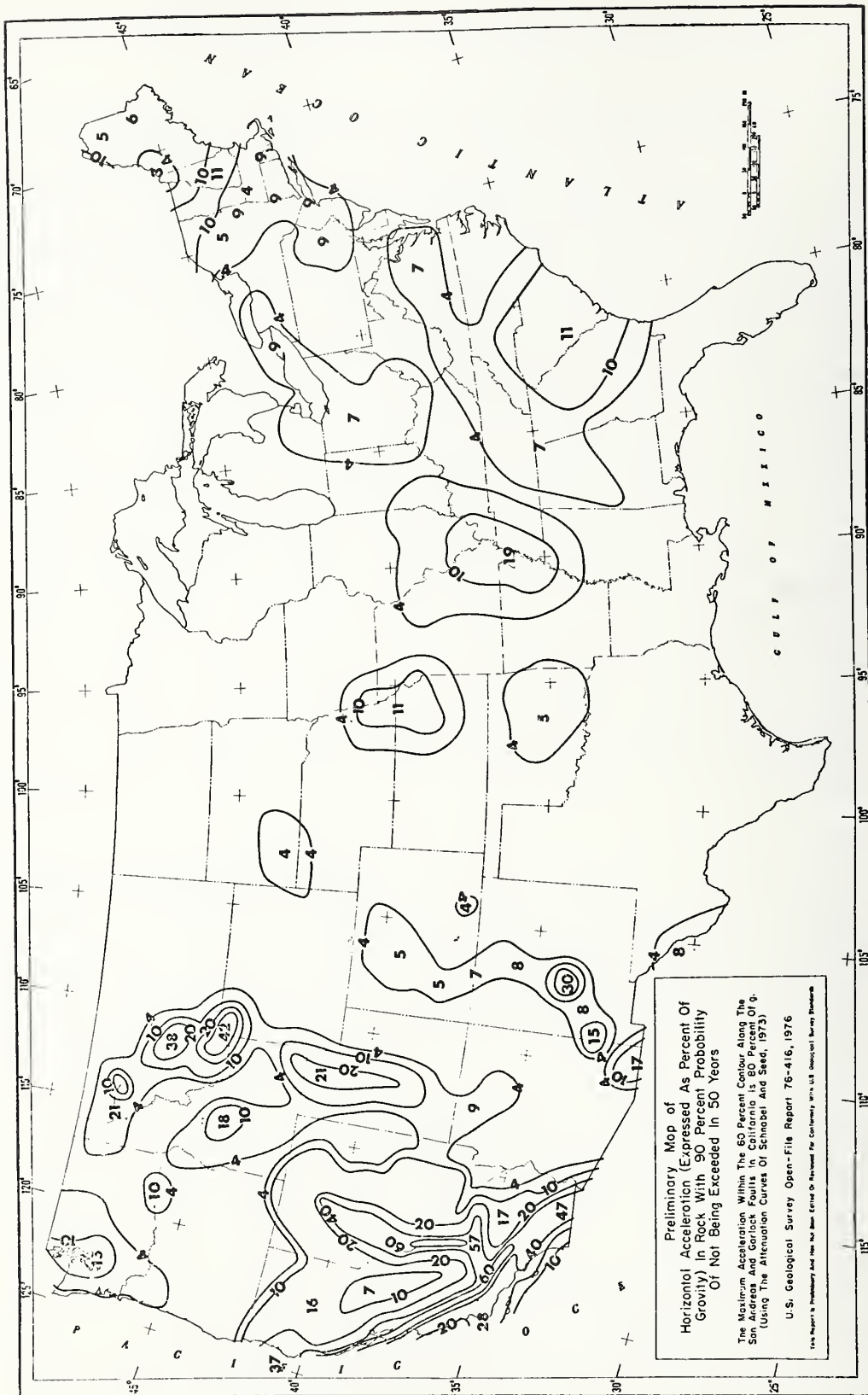

Figure 1 (Algermissen, S.T. and Perkins, D.M., "A Probabilistic Estimate of Maximum Acceleration in Rock in the Contiguous United States, U.S. Dept. of Interior, Geol. Surv. Open File Report 76-416, 1976)

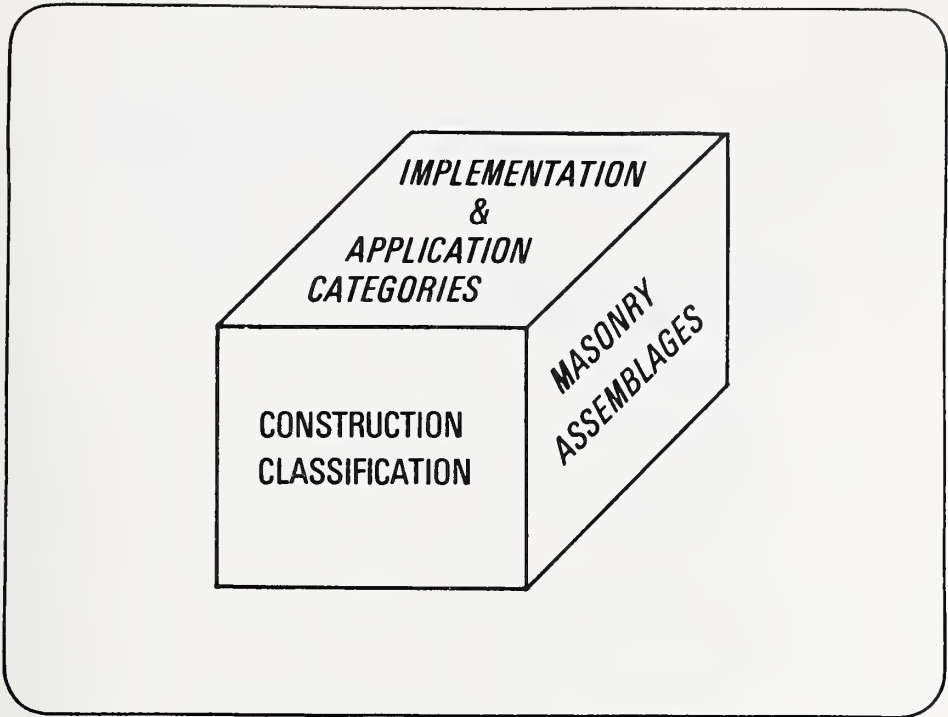

Figure 2

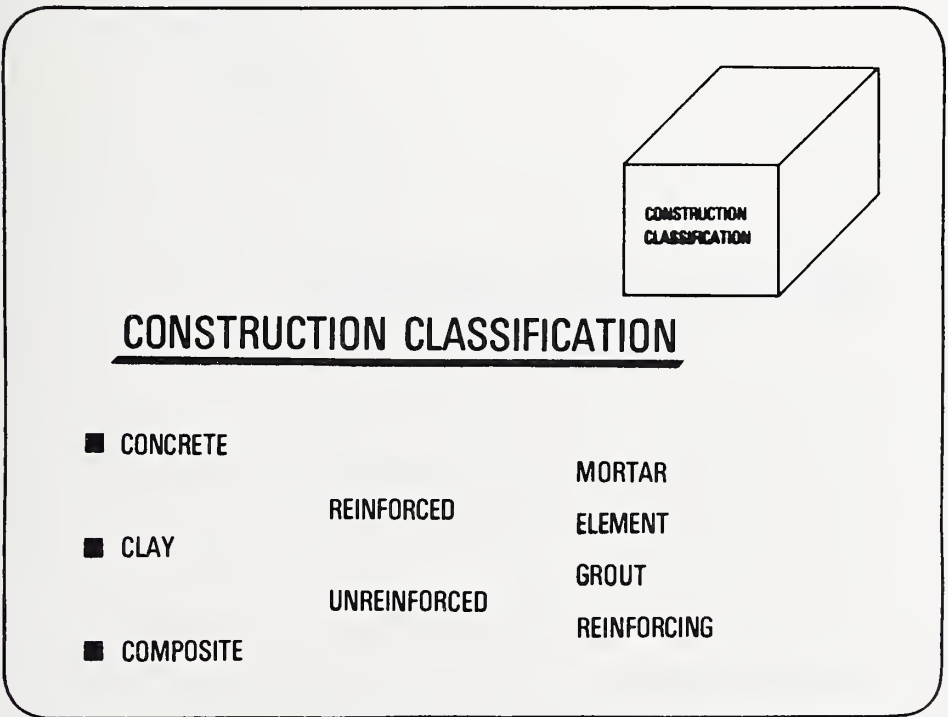
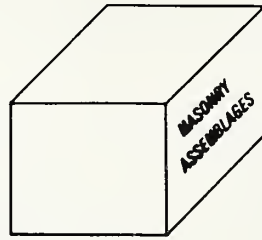

Figure 3



MASONRY ASSEMBLAGES

- SHEAR WALLS
- CURTAIN & PANEL WALLS
- PARTITIONS
- INFILL WALLS
- VENEER
- BEAMS & GIRDERS
- COLUMNS & PIERS

Figure 4

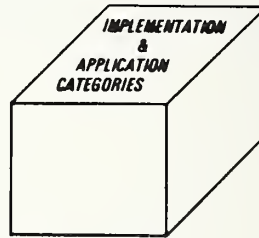

IMPLEMENTATION & APPLICATION CATEGORIES

- DESIGN CRITERIA
- TEST STANDARDIZATION AND MATERIAL PROPERTIES
- MATHEMATICAL MODELS
- REHABILITATION AND RETROFIT
- DESIGN DETAILS
- CODE REQUIREMENTS

Figure 5

DISCUSSION

* * * *

Culver, Session Chairman; National Bureau of Standards:

Both our speakers this morning raised a number of points that perhaps stimulated some questions in your mind. At this point I would like to open the discussion to questions you might have of the speakers or anything they said that you might want to comment on. Let's be as informal as possible.

Mayes, University of California, Berkeley:

Just a suggestion with respect to the first two Working Groups: From my background I don't think there is sufficient information available right now so that we can split those two into two separate Working Groups. We are looking at both groups to develop information for earthquake resistant masonry construction, recommending needed research to alleviate the deficiencies, one with respect to code requirements and the other with respect to design criteria. It seems to me that those two are extremely interrelated and I think you would find the two groups going pretty much along the same path. I would recommend that we combined those two.

Culver:

We have a number of practicing professionals in the audience, and we have a number of regulatory officials. Would anyone care to comment on that? I think, based on our past experience at a workshop, one of the reasons we wanted to get together after we break up into the working groups is to deal with just the problem you mentioned. I think you're going to find when you get into these working groups that they start off rather slowly and that you're working with a small group of people. You will find out when you come back the next day that some of the things you were talking about, the other group was also talking about; maybe along a different vein, but in some cases there was duplication.

We found, for example, at a previous workshop we held, that maybe 10 percent of the specific recommendations that were made were duplicative; two or three groups had made the same recommendation. This is again another reason why we want to go through an iterative cycle. After the workshop is over we plan to send all of you the sum total of the

recommendations so that you can see whether one says essentially the same thing as another only in different language. You bring up a good point, Ron [Mayes]. It's something that we may want to consider. We will get into a discussion of the particular Working Groups tomorrow afternoon after the "formal" presentations are over. So, you all might want to consider the point that Ron brought up.

Noland, Atkinson-Noland and Associates:

With respect to your comment, Ron, I think it depends on what you philosophically expect out of a code. We struggled with this point in the recent rewrite of the Denver code and the question is, "How much criteria do you build into a code, or is a criterion a criterion?"

I personally feel that the code should contain the requirements. The design criteria, perhaps are the body of information that allows you to meet those requirements. Most of the present codes do contain a lot of design criteria and I'm not sure this is quite right.

Clough, University of California, Berkeley:

I wanted to ask Mr. Yorkdale a question about his presentation. The point was brought up several times that he was seeking a rational approach to developing codes and design criteria; and at the same time, he kept indicating that when the earthquake requirements came in, this apparently made it impossible to retain the rational approach to adopt an empirical approach. I was wondering if you could go into some detail on why the seismic criteria require that they drop a rational approach and adopt the empirical approach.

Yorkdale, Brick Institute of America:

Professor, I don't necessarily think that it is required. I think that this has been a method that has been used because of our ignorance of the behavior of the material. I think that we have written a great deal of construction requirements into the design standards which I disagree with, philosophically at least. I think that this has been a way to assure ourselves that the buildings are going to perform as we wish them to. I don't necessarily think that it is required or necessary. I believe that it has been a

way to get the job done with a lack of information at the present time. I don't think that it is inherent.

Clough:

What specific features of the code are established essentially by the empirical and what kind of data are needed, or techniques would be needed to be developed, in order to make those more rational?

Yorkdale:

Very quickly, off the top of my head, the first one I can think of would be the requirements for the area of steel. As Bob [Crist] mentioned a few minutes ago, it seems to me that if we knew more about the behavior of the material and certain other configurations, perhaps of steel or steel reinforcing, that we could get away from the minimum requirements for steel such as maximum spacing, etc., that preclude the design. You end up checking the stresses against what is required by the code rather than designing the structure. (That is the first example I can think of off the top of my head.)

Noland:

Bob [Crist], it seems that one key ingredient in the whole process that has been giving fits, around this area at least, is quality control practices and how you control, to some extent at least, what is going on in the field so that the engineer can have a fair level of confidence that what is being built is what he designed. Do you think we can address this question somewhere in this conference?

Crist, National Bureau of Standards:

I would hope that it would be addressed in two of the Working Groups; for one, in the Test Standardization and Material Properties Group. It was not explicitly stated in the work statement for the Working Groups, but quality assurance, test standardization, all fall into the category of "What can you provide on the job for the compliance officer in seeing that the structure is put together the way the designer wanted it?" With respect to the second, I would hope that in the Design Criteria Working Group, there would

be consideration of the quality of inspection, this concept of different allowable stress levels depending on the quality of construction corresponding to the different levels of inspection.

Culver:

I want to add one small point in line with the question you raised about the need to say something about quality assurance that is illustrated by the previous workshop I keep referring to. At the hearings I mentioned earlier in my presentation, one of the congressmen from California had a copy of the recommendations that came out of that particular workshop. He was looking through them and some were relatively high-sounding recommendations that, really, only a technical person could understand. His comment was to the effect that this is nice but, these recommendations are grandiose and high-sounding; where have we touched upon the real everyday problems that we have in the field, etc. So we don't want to overlook those points in discussing the recommendations. It is interesting how some of these recommendations will come up later. As Bob [Crist] said, the work statement for the task group should not constrain you. We want to make sure, however, we don't go too far off in left field and get into things which are extraneous to the subject.

Hegemier, University of California, San Diego:

My question is directed to Mr. Yorkdale and Mr. Redmond. This morning I heard some rather large numbers, I believe, concerning gross national sales of both brick and block, something like two billion dollars in the case of brick. Is that correct? One? No? Something like one billion in the case of block. Is that in the right ball park? What I would like to know is, what percentage of these numbers is presently going to research? For example, to be specific, for structural properties of these materials. I don't mean to be facetious; I really don't know.

Yorkdale:

That is a good question to answer. The figures, I believe, were the maximum gross sales from the brick industry that we have attained so far -- 451 million dollars; there is about a 12-billion brick equivalent prospect. As far as the amount of this income that has been returned to the industry is concerned, (I'm guessing, now, purely off the top of my head) I would think that the brick industry invests, totally, in association work which includes design standards, research, technology, etc., something near one percent. That also includes some promotion of this type of thing or educational information. I would think something near one percent for those that are active in the associations and, as I mentioned, that represents about one third of the total companies or about two thirds of the total productive capacities.

Crist:

I would like to direct a question to Tom Redmond and Alan Yorkdale. I think we talked about this a little bit when we were discussing what they would present at the workshop. In planning research and looking at how you can use that research in codes and standards, the superposition of the distribution of these dollars of construction in both concrete and clay masonry onto a seismic map would tell us a lot about what's going on. Do we have much feel for this or is there something that is available like that?

Yorkdale:

I can give you, again, an off the top of my head estimate but I have the figures available and they certainly can be superimposed on a seismic map. Essentially 90 percent of the brick that is made and used is used from the Rocky Mountains to the East and better than 70 percent of that is used from the Mississippi River to the East. I think this probably indicates one of the reasons why we have not been terribly interested in seismic masonry; (I wouldn't say "not terribly interested") rather, why we haven't devoted as many funds as perhaps should have been devoted to it.

Redmond, National Concrete Masonry Association:

I think Al's [Yorkdale] distribution figures would be somewhat relative also for the concrete masonry industry, and I think in our case, perhaps a little less than one percent west of the Rockies. I don't know the figure east of the Mississippi. Getting back for a minute to the question by Gill Hegemier that I didn't have a chance to answer: in association work, we only spend at this time (in terms of at least direct monies) about ten percent of our association budget directly in research in our own facilities. However, we do try to become active participants in other research done in other places. Of course a great deal of this is federally funded, perhaps not quite as high a percent federally funded in masonry as it is in wood products today.

What was the other part of your question, Bob [Crist]?

In terms of perhaps not seismic but in terms of reinforced masonry, we see an ever increasing amount of it in concrete masonry (and I am sure in clay masonry as well) with the advent of high-rise load-bearing construction, because, quite often, your wind loads are just about as critical as, say, Earthquake Zone 2, or 3, loads might be for some particular building configurations. So I think we are undergoing an ever increasing awareness of reinforced masonry in the industry.

Hegemier:

Let me just approach this question once again. Could I obtain an estimate in terms of an actual dollar amount? What are we spending from the industry; that is, what is the industry's contribution to research combined for brick and block?

Redmond:

I'm not prepared to answer for the block end of the industry because I would think that you should consider money from the industry as coming from more than just brick producers or block producers. For instance, there is a considerable amount of money coming in that will be available and is available for research, from other groups such as mason contractors and masons themselves. For example, the Masonry Institute of America (with

Jim Amrhein here), gets involved in quite a bit of work. So, answering just in behalf of the product producers, I don't think this would reflect the answer and I will have to figure it up and try to answer the question later in the week. All right?

Yorkdale:

I was just trying to get you a ball park figure to give a feel for this. The combined groups of the masonry industry on a national basis, (I'm talking about the national groups, not some of the more localized groups; and I don't know what Tom's [Redmond] budget is) have recently spent on national problems approximately \$125,000 to \$150,000 in the last two and one half years. Now in addition, the Brick Institute (formerly, Structural Clay Products Institute and before that, Structural Clay Research Foundation) used to spend upwards of \$95,000 to \$100,000 per year in our own laboratory in addition to what we farmed out or used as seed money for other research in universities, at other laboratories, and in combined work. But I'm like Tom; I can't give you a total. I just don't know what it is, frankly.

Culver:

I note that there seems to be one interesting thread going through the course of the conversation and I think this is why we structured this morning's session this way - to give a perspective overview. You will all be grappling, this week, with "How important are the problems?" Bob [Crist], talked, first of all, about the priority order of problems in the masonry area. This is one of the things we are looking for. This particular workshop is directed towards seismic resistant masonry construction. But I think one of the things that we all hope would come out of this is a priority listing -- "putting the problem in perspective", so to speak. That is what all the speakers were addressing this morning. Now you can attempt to do this in all sorts of ways - dollar volume, square footage, regionalization, etc., etc. What we need to consider is: What are the problem areas in masonry? - Can we prioritize them? - If so, let's attempt to do so. There are many other competing national needs and we need to point out just how important this particular problem is.

Yorkdale:

One other thing I wanted to point out on this (and I forgot to say it) was that (if we could believe Arthur D. Little's survey and report) masonry materials still represent only somewhere in the neighborhood of 15 to 16 percent of total masonry construction cost; so, we can't do it all. That is the only thing I was suggesting.

Clough:

I would like to come back to a point that Mr. Redmond made which was that in high-rise buildings in Zones 2 and 3 the wind loading may well be as critical or more critical than the seismic. This, of course, is a conclusion one can draw according to the particular code that one happens to be looking at. However, I would like to emphasize that the code requirements which are frequently indicated for seismic design are way below actual earthquake input to structures; and consequently, even though one concludes that the wind may be the critical code condition, the thing that is actually the most hazardous as far as the structure is concerned, is likely to be the earthquake. I hope in this meeting that we will not just look at what the code says the earthquake is, but recognize the real relative input from earthquake versus wind or whatever kind of loading mechanism we might have.

Scalzi, National Science Foundation:

Looking at Groups 1 and 2 and the amount of discussion that is going on about brick and concrete block, I'm wondering if there shouldn't be a couple of subcommittees to treat the materials separately; or, I will ask the question, "Are they similar enough so that they can be treated together?" I think this might bring up some differences or similarities between the two products.

Mayes:

I think the problems that have to be solved are similar enough. I think the results you will get from solving those problems may be different for the two materials but, right

now, I think they are both at a stage where they both need the same amount of work developed for them.

Culver:

One comment I might make, (this is just my own personal view) regards the kinds of recommendations we want to try to come up with at this workshop. I think you have to be careful of the two extremes. First of all, if you go to the one extreme and just have really extreme broad generalities, that is not going to serve the purpose; but by the same token, if we go to the other end of the spectrum and say that a particular series of tests should be run with reinforcing spaced at twenty-two inches on centers, under loads of x, y, z, I think that is too far the other way, too. We have to be careful to try and strike some happy middle ground with the idea being that these recommendations need to be useful to a broad spectrum of people, not only the National Science Foundation researchers, but also code officials, etc. Let's be careful that we don't fragment ourselves too much. That is my only general observation.

Gabrielsen, San Jose State University:

I would like to ask Al [Yorkdale] a question about the rational approach or quite what he means about it? Is the empirical approach irrational? Am I to infer that? When I think of an empirical approach I think, for example, that ultimate strength design of concrete is very empirical. We ran a lot of tests (Whitney did) and now we have some nice formulas in a text book. That doesn't make it rational; it's empirical. It is a good procedure for predicting performance of a beam. As such, I don't see things that are negative about empirical techniques. That is my question: Is empirical necessarily irrational?

Yorkdale:

I think, maybe, I agree with you. I think we are playing a game of semantics here, a little bit. The empirical design, I believe, that I, at least, would like to see us get away from is the case that if you are going to build a wall thirty-five feet high it has to be at least twelve inches thick of solid brick; and if it is going to

go seventy feet high it has to be sixteen inches at the bottom, and the top thirty-five feet can be twelve inches; and you have to have lateral support at twenty times the thickness in at least one direction, not two. (You could go up forever with lateral support just in one direction). This is the type of thing. I don't believe that all of the straight design of concrete is anything near that. I believe that if we try to test, or examine, or duplicate all of the possibilities for the empirical design approach that I am talking about, it would take us several hundred years to do it. I believe that we can learn about material behavior as was done in concrete and that we can apply some common sense, if you will, to that and come up with similar types of formulas that would be more rational, at least in their results and applications. (That is a bad answer I'm afraid.)

Hildebrandt, City of Phoenix:

At the risk of robbing myself of a few things I would like to say tomorrow when my turn comes, I would like to tag onto a couple of things that have been said from a code viewpoint. The matter of whether we call something empirical is not so important, in my view, as how it is applied in code; and perhaps we are hung up with words. You have to make up your mind, in a code provision, whether it is going to be prescriptive or end result, and almost always, people say we want an end result code. The minute you write one like that you have sixty-seven people on your back wanting you to tell them how to do it. I think that is the difference we see when we talk about the empirical approach versus the rational approach. If we are going to devote part of our time here to coming up with suggested code revisions and provisions, I think that the code enforcement people will go with either empirical or rational, but somebody has to tell us where to draw the line. Getting back to the just previous question of perhaps trying to be more specific in separating how we address ourselves to the points here, I would like to strike a blow for not doing that, because I think our move has to be to condense and combine code requirements rather than proliferate them forever or we are going to need a wheelbarrow to carry our code books around. Let's talk about unit masonry - and they can make it out of organic products, brick, clay, concrete or anything - but let's make it something that has an engineering basis and then tack code provisions on the whole schmeer, in so far as we can.

Fintel, Portland Cement Association:

I would like to add some comments to this discussion of empirical versus rational. I believe that masonry construction has been, over the years, kind of a stepchild of the structural engineering development. If you compared it, let's say, to the ultimate strength design in reinforced concrete, it is, in a way, empirical. However, it is rational because it is based on structural mechanics for the behavior of the material, while all the developments in masonry, basically, were developed on experience without a theoretical basis of such - or, mechanics.

Sears, Veterans Administration:

I believe the gentleman from Phoenix really answered my question but there is one other little thing that I might say. It appears to me that there is empiricism all the way through building design even though, interspersed, there is a lot of rational approach. Really, our loads in the buildings themselves are very empirical - not entirely, but quite a bit.

* * * *

SEISMIC RESEARCH ON MASONRY
UNIVERSITY OF CALIFORNIA, BERKELEY
1972 - 1977

Ronald L. Mayes^(I), Ray W. Clough^(II) and Yutaro Omote^(III).

This paper describes the scope of the seismic research program that has been ongoing at the Earthquake Engineering Research Center, University of California, Berkeley since September, 1972. The program currently has two major parts. The first is an experimental and analytical study of multistory buildings and the second is an experimental study of housing construction. A summary of results of tests completed to date is included together with a description of tests currently in progress and those planned in the near future.

Key Words: Masonry, seismic, shear walls, houses, research, spandrel beams, piers, connections.

1. INTRODUCTION

A masonry research program was initiated at the Earthquake Engineering Research Center, University of California, Berkeley in September 1972 and has continued for the past four years. The program currently has two major parts. The first is an experimental and analytical study of multistory masonry

I - Assistant Research Engineer, University of California, Berkeley;
Principal, Computech, Berkeley, California.

II - Assistant Director, Earthquake Engineering Research Center, University of California, Berkeley.

III - Assistant Research Engineer, University of California, Berkeley.

buildings, and the second is an experimental study of masonry housing construction.

The program on multistory buildings has been in progress for four years and consists of three major parts. The first, which has been completed, is a series of seventeen in-plane shear tests on a double-piered test specimen. The second, which is in progress, consists of a series of eighty in-plane shear tests on a single-pier test specimen. The third, which is planned to begin in September 1977 consists of a series of tests on spandrel girders. In addition to this experimental work, recent Uniform Building Codes have been evaluated to determine their adequacy in protecting masonry structures against severe damage or collapse in an earthquake. This study is presented in another paper in these proceedings and in reference (1).

The program on housing construction has been in progress for nine months and is currently planned to consist of two major sections, both of which will begin in May 1977. The first section consists of a series of shaking table tests on panels of a masonry house; the second consists of a series of tests on typical connection details of masonry housing construction.

Details of these programs will be described in more detail in the following sections, although it is not possible in this paper to give the complete set of results for work completed.

2. MULTISTORY MASONRY TEST PROGRAM

After an extensive review of literature [2,3] dealing with earthquake resistance of masonry, it was concluded that exterior wall panels penetrated by numerous window openings (Fig. 1) were the components of multistory masonry buildings most frequently damaged in earthquakes, and it was decided to make an experimental study of the seismic behavior of such components. A testing fixture was designed to subject typical full-scale window piers to combined static

vertical (gravity) and cyclic lateral (seismic) loads (Fig. 2), and the stiffness and strength of a series of 17 double-pier wall panels were measured (Fig. 3). Results of these tests [4,5] indicated significant variations of the pier behavior with the various test parameters--dimensions, types of reinforcing, rate of loading, etc.--but the results were not conclusive and demonstrated the need for more extensive tests to establish definitive parametric relationships.

The cost of the two-pier tests, both in money and in time, precluded carrying out the extensive parametric variations which are needed by this test procedure; consequently a single-pier test system was devised which greatly simplified the investigation (Fig. 4). Preliminary studies showed that single-pier results could be obtained which were comparable to the two-pier tests; hence a large number of single-pier tests were planned for 1976-77.

Details of both the double and single-pier test programs are discussed in the following sections.

2.1 Double-Pier Tests

The primary shear resisting elements of multistory reinforced masonry buildings are vertical cantilever, coupled or perforated, shear walls such as those shown in Fig. 1. The smallest structural components of interest in the perforated shear walls are the single or double-pier elements circled in Fig. 1. A complete understanding of the earthquake behavior of these elements will be of great help in developing a more realistic model of an entire perforated shear wall and also will aid in understanding the behavior of the coupled and cantilever shear walls. The advantages of the double-pier element, Fig. 3, are the realistic boundary conditions which are provided for the piers, and the ability of the panel to represent reversal of the overturning moment when subjected to a cyclic load. The major disadvantages of such test specimens are

the time and cost involved in their construction and testing, as compared with a single pier.

The double-pier test program consisted of seventeen tests on specimens whose dimensions are shown in Fig. 3, utilizing the test set-up shown in Fig. 2. Information that was determined from the test program included: a) yield and/or ultimate strengths; b) mechanism of failure; c) hysteresis characteristics; d) ductility; e) stiffness degradation; and f) energy absorption characteristics.

Typical hysteresis loops are presented in Figs. 5 and 6. To interpret and compare the results of the hysteresis loops, several indicators were determined from the plots as follows:

(a) Peak Ultimate Loads - P_{u1} and P_{u2} .

These are the maximum loads, in each direction, that were attained during a test.

(b) Average Ultimate Loads - P_1 and P_2 .

The loads P_1 and P_2 , in each direction, were approximately 90% of the mean of the peak ultimate loads; they were maintained for more than one cycle of input displacement.

(c) Working Ultimate Load - P_3 .

P_3 was chosen as the load at which the first visible cracks formed in the piers. P_3 varied between 70 and 80% of the mean of the peak ultimate loads.

(d) Ductility Indicators - δ_1 to δ_4 .

Ductility indicators associated with P_1 , P_2 and P_3 were defined to give an indication of the displacement range over which loads P_1 , P_2 and P_3 were maintained. δ_1 and δ_2 are associated with the average ultimate strengths P_1 and P_2 , and are defined as the ratio of the displacement at which the pier can no longer withstand the lateral load P_1 or P_2 to the displacement at which P_1 or P_2

is first attained. δ_3 and δ_4 are similar ratios, in each direction, associated with the load P_3 .

P_{u1} , P_{u2} , P_1 , P_2 and P_3 are indicated in Fig. 5. The mean of the loads P_{u1} and P_{u2} , the mean of the loads P_1 and P_2 , and P_3 and their respective shear strengths based on the gross area of 192 sq. in. are listed in Table 1.

δ_1 to δ_4 are defined as $\delta_1 = \frac{d_3}{d_2}$; $\delta_2 = \frac{d_7}{d_6}$; $\delta_3 = \frac{d_4}{d_1}$ and $\delta_4 = \frac{d_8}{d_5}$ where d_1 to d_8 are defined in Fig. 6.

A summary of the test results obtained from the hysteresis loops is presented in Table 1 and the complete set of results is presented in References (4,5). One of the most important parameters with respect to the seismic resistance of the piers is the ductility.

A note of caution is made at this point with respect to the ductility indicators, in that they cannot be considered in isolation when evaluating the inelastic performance of the piers. First, the initial displacement at which the ductility indicators are measured $\frac{d_2 + d_6}{2}$ for $\frac{\delta_1 + \delta_2}{2}$ and $\frac{d_1 + d_5}{2}$ for $\frac{\delta_3 + \delta_4}{2}$ (see Fig. 6 for the definition of d_1 , d_2 , d_5 and d_6), must be used in order to evaluate the displacement range over which the ductility indicators are valid. For example, Tests 1 and 8 have the same values of $\frac{\delta_1 + \delta_2}{2}$ and $\frac{\delta_3 + \delta_4}{2}$ but Test 8 (Fig. 7) obviously has a much more desirable inelastic behavior. Secondly, the maximum displacement the piers can withstand before failure is also important. For example, Tests 9 and 10 have reasonably large values of $\frac{\delta_1 + \delta_2}{2}$ and $\frac{\delta_3 + \delta_4}{2}$ compared to Tests 1 and 2, but the piers of 9 and 10 completely collapsed at a lateral displacement of 0.5" whereas Tests 1 and 2 did not collapse until displacing 1.0". These two factors illustrate the limitations of the ductility indicators and demonstrate the necessity of including with the ductility indicators, the displacement range over which they are valid and the maximum lateral displacement the piers

can withstand, in characterizing the ductility of the piers.

For a more complete description of the test results and their correlation with other work performed in this area, the reader is referred to references 4 and 5.

2.2 Single-Pier Tests

During the testing of the two-pier panels, it was found that the test program was very costly, in terms of both time and money, and efforts were made to determine whether a test of a single pier could give equivalent results. Using the test system shown in Fig. 4, it was found that the boundary conditions of the two-pier tests could be simulated adequately. As the pier is displaced laterally, the hinged columns constrain the top of the pier against rotation similarly to the action of the spandrel girders of the two-pier test. The correlation between the single and two-pier test has been studied extensively⁽⁶⁾ using displacement and strain gages, and the essential behavior mechanisms were seen to be similar.

Fifty-seven tests are planned as the first phase of the single-pier test program (1976-77), with variables shown in Tables 2, 3 and 4. Dimensions of the test specimens are shown in Figs. 8-12; materials are hollow clay brick (25 tests), grouted core clay (16 tests), and concrete block (16 tests). In addition to material, the principal test variables are (1) height: width ratio, (2) amount of horizontal and vertical reinforcement, and (3) effect of full or partial grouting. Variables of an additional sequence of 23 tests will be selected on the basis of results of the first phase. The ultimate objective of the single-pier tests is to determine reinforcing requirements to obtain desirable inelastic performance of the piers. Results similar to those from the double-pier test program will be obtained.

In conjunction with the single-pier test program a series of diagonal

compression tests (Fig. 13) will be performed on panels 2'-8" square, constructed with the same masonry units and mortar and grout. The purpose of this supplementary test program is to determine whether there is any significant correlation between strengths indicated by this type of test as compared with the pier specimen tests. If such correlation can be established, it will greatly increase the significance of the extensive data already available from diagonal compression tests.

2.3 Spandrel Beam Study

As is evident in Fig. 1, a pierced wall panel is essentially an assemblage of window piers and spandrel beams, interconnected by rectangular joint blocks. Experience in past earthquakes had indicated that the window piers were the critically stressed elements in many masonry structures, but it is apparent that the spandrel beams could be critical if they were more slender than the piers. In some cases the piers are wide shear walls and the spandrels may be heavily stressed if they serve to interconnect such shear walls.

Accordingly, it was decided to make a preliminary study of the spandrel girder problem during 1976-77. The first phase of the work will be a literature survey to determine what previous work has been done on this subject. Based on the data obtained in the survey, preliminary planning of the test program will be considered--including selection of appropriate test specimens, design of a testing facility (probably adapted from two-pier panel test facility) and specification of the principal test variables.

3. MASONRY HOUSING CONSTRUCTION

3.1 Introduction

The basic purpose of the masonry research project funded by the Department of Housing and Urban Development is to evaluate experimentally the seismic

resistance of masonry construction typical of single family residential construction. Very little research has been carried out previously on the seismic resistance of such structures, so a major preliminary step was to survey the types of masonry houses built in seismic zones and to identify the types of building components and connection details most likely to be damaged during earthquakes^(7,8). The next step in the research was the planning of appropriate test procedures and the design of suitable test specimens to demonstrate the effective seismic strength of typical structures. It is the purpose of this section of the paper to describe and catalog the tests which are to be carried out during this research effort, beginning in May 1977.

Currently, two types of tests are proposed. These are (a) tests of connection details, interconnecting timber roof structures to masonry walls, and (b) shaking table tests of segments of masonry panels that form the lateral force-resisting system of the dwelling. If the test results of (b) indicate that additional in-plane shear tests or out-of-plane flexural tests on segments of a panel are required, these will be performed in 1978. The tests are planned to apply loads to the test specimen in the same way as expected earthquake accelerations.

A major practical consideration in planning the test program was the relatively limited number of tests which could be performed within the budget in comparison with the number of test parameters which should be considered. Consequently, only the most important parameters could be varied, and relatively little duplication of tests could be included to study the variability of results. In general, only tests of connection details will be carried out in duplicate. The specimens used in each of these duplicated tests will be constructed on two different days by different masons, in order to assess the variability of construction that might be expected in the field.

Although numerous types of masonry units are in current use, only two

types will be used in these tests, as follows:

- (a) Hollow clay units - 6 inches wide, 4 inches high and 12 inches long, with compressive strength of 7,000 psi calculated on the gross section area.
- (b) Hollow concrete block units - 6 inches wide, 4 inches high and 16 inches long, with compressive strength of 1,000 psi calculated on the gross section area.

Mortar to be used in all test specimens will be standard Type S of the Uniform Building Code with proportions 1C: $\frac{1}{2}$ L: $4\frac{1}{2}$ S. The grout for filling cells will be the standard 1C: 3S mixture for concrete block and 1C: 3C: $2\frac{1}{2}$ Pea Gravel (< 3/8") for clay brick.

The reinforcement was planned for the test specimens according to the philosophy that future reinforcement requirements will be no more severe than current Uniform Building Code requirements for partial reinforcement. Consequently, the test panels for the shaking table tests have either no reinforcement or partial reinforcement, such as is specified by the Uniform Building Code (as well as other codes). Specifically, in the partially reinforced panels reinforcement is to be provided around the edges of all openings, and vertical bars will be placed at 8-foot centers on large panels.

Connection Tests

The connection test program is designed to determine the ultimate capacity and mode of failure of typical connections used in masonry housing construction. The connection of timber roof systems to masonry walls is one of the most important details. Figure 14 shows a typical connection of sloping roof structure to the top of a masonry wall, while Fig. 15 shows the attachment of the gabled end of a sloping roof structure to the top of a masonry wall. Figure 16 shows the attachment of a flat roof to the inner face of the wall by means of

a ledger.

Two types of tests will be performed to evaluate the strength of the connection of the timber roof system to the top of the wall (Fig. 17). These are characterized by the principal load components acting in the plane of the wall and out of the plane of the wall. In planning the tests, it has been assumed that the critical connecting elements are the bolts and other metal connectors, and their contact with the timber and masonry. The masonry components themselves are assumed to have more than adequate strength, so these have not been simulated in the tests with great detail. The test specimen for the in-plane and out-of-plane tests is shown in Fig. 17. The test set-up for the in-plane tests is shown in Fig. 18. The test specimen includes the top plate and bolts, which is loaded through a horizontal plywood element simulating the roof diaphragm. Initially only one type of bolt embedment will be used--a 5/8 inch bolt anchored 8 inches into the wall with a 2 inch 90° bend. If failure occurs either in the masonry wall or in the bolt, these will be varied in additional tests.

The test set-up for the out-of-plane tests is shown in Fig. 19. Again if failure occurs either in the masonry wall or in the bolt, both will be varied in additional tests.

The test specimen for the out-of-plane tests on the gabled end connection detail is shown in Fig. 15. The test set-up for these tests will be that shown in Fig. 19. For the ledger connection detail, only out-of-plane force will be the same as that used in the previous out-of-plane tests--Fig. 19. For the detail in which the roof joints connect to the ledger plate, three variables will be tested. The first will be as shown in Fig. 20 with a 5/8 inch bolt and washer. In the second the washer will be replaced with a 1/4 inch by 6 inch by 2 inch plate. In the third, a 1/4 by 2 inch wide Simpson Strap shown in Fig. 16, will be used with the 5/8 inch bolt and washer. For the flat roof detail

in which only the plywood is connected to the ledger, the test specimen is shown in Fig. 21. The same three variables used with the joists will be used in those tests.

Shaking Table Tests

The shaking table test program, which will be performed concurrently with the connection tests, is envisioned as a type of proof test. Segments of masonry walls of a typical dwelling will be subjected to both in-plane and out-of-plane forces arising from realistic earthquake loading conditions. In 1977 a total of four tests are planned.

The first test specimen is shown in Fig. 22. Although simple in concept it contains the most important structural components: wall panels, corners, wall to footing connections, and roof to wall connections. As shown in Fig. 22 two of the 9 ft by 8 ft walls will be unreinforced and two will contain No. 4 re-bars at the outside edges of the walls. The re-bar will be dowelled into the footings. In order to simulate the vertical and lateral loading conditions the walls would be subjected to in a normal dwelling, added mass in the form of concrete blocks will be attached to the roof. Although the sequence of loading has not yet been finalized, three different types of recorded earthquake motions will be used. The earthquake records will be scaled and in each test sequence the magnitude will be increased until either failure occurs or the limits of the shaking table are reached. If failure does not occur, two additional series of tests will be performed with the same specimen. First the roof structure will be rotated 90 degrees. In the first series of tests the in-plane shear forces will be transferred through the roof diaphragm by the sloping portion of the roof structure and the out-of-plane forces of the walls will be resisted by the gabled end of the roof structure. By rotating the roof structure 90 degrees, this sequence of load resistance will be reversed.

If failure does not occur in the second series of tests, a third series will be performed in which the rotational fixity of the footings will be removed. As shown in Fig. 22, the footings to which the walls are attached are anchored both horizontally and vertically. By removing the bolts that connect the angles to the concrete footing, the footings will lose their rotational fixity and thereby approach actual field conditions.

The details of the remaining three test specimens will not be finalized until the first test is completed. Variables that may be included are (a) the introduction of torsion using non-symmetric wall panels, (b) the use of different masonry units, and (c) different amounts of reinforcement including non-dowelled vertical reinforcement. As a final proof test the specimen shown in Fig. 23 will be used.

ACKNOWLEDGEMENTS

The multistory masonry research program is jointly funded by the National Science Foundation, the Masonry Institute of America and the Western States Clay Products Association. The masonry dwelling research program is funded by the Department of Housing and Urban Development. The sponsorship of these institutions is gratefully acknowledged.

REFERENCES

- 1) Mayes, R.L., Omote, Y., Chen, S.W. and Clough, R.W., "Expected Performance of Uniform Building Code Designed Masonry Structures," University of California, Berkeley, California, EERC Report No. 76-7, September 1976.
- 2) Mayes, R.L. and Clough, R.W., "A Literature Survey - Compressive, Tensile, Bond and Shear Strength of Masonry," University of California, Berkeley, California, EERC Report No. 75-15, June 1975.
- 3) Mayes, R.L. and Clough, R.W., "State-of-the-Art in Seismic Shear Strength of Masonry - An Evaluation and Review," University of California, Berkeley, California, EERC Report No. 75-21, October 1975.
- 4) Mayes, R.L., Omote, Y. and Clough, R.W., "Cyclic Shear Tests on Concrete Masonry Piers, Volume 1 - Test Results," University of California, Berkeley, California, EERC Report No. 76-8, May 1976.

- 5) Mayes, R.L., Omote, Y., Chen, S.W. and Clough, R.W., "Cyclic Shear Tests on Concrete Masonry Piers, Volume 2 - Analysis of Test Results," University of California, Berkeley, California, EERC Report No. 76-16, June 1976.
- 6) Anvar, S.A., "A Study of Shear in Concrete Masonry Piers," M.S. Thesis, University of California, Berkeley, California, June 1975.
- 7) Clough, R.W., Mayes, R.L., Omote, Y. and Chen, S.W., "Summary of Findings of a Field Trip to the Department of Housing and Urban Development Offices in Regions VIII & IX," University of California, Berkeley, California, EERC, (internal report), March 1977.
- 8) Omote, Y., Mayes, R.L. and Clough, R.W., "Transverse Strength of Masonry Walls - A Literature Survey," University of California, Berkeley, California, EERC Report No. UCB/EERC-77/07, (to be published).

TABLE 1: SUMMARY OF TEST RESULTS

TEST NO.	Frequency (1) (cps)	Bearing Stress (2) (psi)	Vertical Reinforcement (3)	Horizontal Reinforcement (4)	$\frac{P_{u1} + P_{u2}}{2}, \frac{\bar{u}_1 + \bar{u}_2}{2}$ (kips) (psi)	$\frac{P_1 + P_2}{2}, \frac{\bar{v}_1 + \bar{v}_2}{2}$ (kips) (psi)	P_3, \bar{v}_3 (kips) (psi)	$\frac{\delta_1 + \delta_2}{2}$ (in)	$\frac{d_1 + d_2}{2}$ (in)	$\frac{\delta_3 + \delta_4}{2}$ (in)	$\frac{d_1 + d_5}{2}$ (in)	Max. Input Stroke of Actuator (in)
1	0.02	250	2 - #6	--	26.0 135	24 125	20 104	1.55	.095	3.5	.065	1.0
2	3	250	2 - #6	--	33.2 173	31 161	28 146	1.55	.130	2.4	.095	1.0
3	0.02	125	2 - #4	--	27.3 142	26 135	21 109	1.5	.180	4.1	.105	1.0
4	3	125	2 - #4	--	26.0 135	22.8 119	18 94	1.8	.165	5.6	.085	1.0
5	0.02	0	2 - #6	--	20.5 107	18.5 96	15 78	1.55	.180	5.6	.075	1.0
6	3	0	2 - #6	--	25.5 133	21.7 113	19 99	1.85	.105	5.3	.070	1.0
7	0.02	250	2 - #6	1 - #5	40.7 212	39 203	33 172	1.5	.235	4.4	.123	0.7
8	3	250	2 - #6	1 - #5	48.4 252	44 229	33 172	1.45	.350	3.0	.180	1.0
9	0.02	500	2 - #6	--	29.5 154	28.7 149	24 125	2.1	.080	4.1	.060	0.45
10	3	500	2 - #6	--	34.1 178	32.7 170	28 146	2.8	.130	5.6	.055	0.5
11 (13)	0.02	250	2 - #6	--	20.0 104 (132)	18.9 98 (124)	17 89 (113)	3.8	.120	6.5	.055	0.5
12 (13)	3	250	2 - #6	--	21.8 114 (143)	20.6 107 (136)	18 94 (119)	5.1	.065	8.1	.048	0.55
13	0.02	125	2 - #4	3 - #7, 2 - #5	29.1 151	26.0 135	18 94	1.8	.215	5.2	.075	1.0
14	3	125	2 - #4	3 - #7, 2 - #5	28.8 150	24.0 125	19 99	3.1	.160	6.6	.080	0.9
15	0.02	125	2 - #4	3 - #7, 2 - #5	35.2 189	33.6 175	23 120	2.5	.320	9.2	.090	1.5
16	3	125	2 - #4	3 - #7, 2 - #5	36.2 189	32.4 169	22 115	3.4	.190	10.5	.090	1.5
17	3	250	--	--	23.7 123	20.7 108	17 89	1.6	--	--	--	0.7

Notes of Table 1

1. Frequency of the sinusoidally applied actuator displacement.
2. Bearing stress based on the gross area (192 sq. in.).
3. Vertical reinforcement in each jamb of the piers.
4. Horizontal reinforcement.
5. P_{u1} and P_{u2} are the peak shear loads in either direction, and defined in Fig. 5. τ_{u1} and τ_{u2} are the corresponding shear stresses based on the gross area.
6. P_1 and P_2 are the average ultimate shear strengths as defined in Fig. 5. τ_1 and τ_2 are the corresponding shear stresses based on the gross area.
7. P_3 is a working ultimate shear strength defined in Fig. 5. τ_3 is the corresponding shear strength based on the gross area.
8. δ_1 and δ_4 are approximate ductility ratios associated with P_1 and P_2 and defined in Fig. 6.
9. Average value of deflection associated with P_1 and defined in Fig. 6.
10. δ_3 and δ_4 are ductility indicators associated with P_3 and defined in Fig. 6.
12. Maximum input displacement of activator.
13. Grouted at re-bars only. Values in parentheses are stresses based on net area. (152 sq. in.).

TABLE 2: HOLLOW CLAY BRICK WALLS (HCBR) (See Figs. 8-10)
 Unit W:L:H = 8" : 12" : 4"

Name of Tests	.H/D Ratio	Bearing Load (kips)	Reinforcement		Grouting F: fully P: partial	Expected Failure Mode	Loading Rate s: static d: dynamic
			Vertical	Hori- zontal			
HCBR-11-1	1:1	Minimal (50 psi)	NO	NO	F	Shear	D
" -2	"	"	"	"	p	"	"
" -3	"	"	1 - #5 (Totl. 2 - #5)	"	F	"	D
" -4	"	"	"	1 - #5	"	"	"
" -5	"	"	"	"	p	"	"
" -6	"	"	"	5 - #5	F	Flexure	S
" -7	"	"	"	"	"	"	D
" -8	"	"	1 - #8 (Totl. 2 - #8)	NO	"	Shear	"
" -9	"	"	"	"	p	"	"
" -10	"	"	"	2 - #5	F	"	"
" -11	"	"	"	"	p	"	"
" -12	"	"	"	5 - #6	F	Flexure	S
" -13	"	"	"	"	"	"	D
HCBR-21-1	2:1	"	NO	NO	F	Shear	D
" -2	"	"	"	"	p	"	"
" -3	"	"	1 - #5 (Totl. 2 - #5)	"	F	Shear & Flexure	"
" -4	"	"	"	1 - #5	F	Flexure	D
" -5	"	"	"	"	p	"	"
" -6	"	"	"	5 - #5	F	"	S
" -7	"	"	"	"	"	"	D
HCBR-12-1	1:2	"	NO	NO	F	Shear	"
" -2	"	"	1 - #5 (Totl. 3 - #5)	"	"	"	"
" -3	"	"	"	2 - #5	"	"	"
" -4	"	"	"	5 - #6	"	Flexure	"
" -5	"	"	1 - #7 (Totl. 3 - #7)	3 - #6	"	Shear	"

TABLE 3: GROUTED CORE BRICK WALLS (See Figs. 8-10)

Unit W:L:H = 3" x 12" x 4" (Wall W = 9")

Name of Tests	.H/D Ratio	Bearing Load (kips)	Reinforcement		Grouting F: fully P: partial	Expected Failure Mode	Loading Rate s: static d: dynamic
			Vertical	Hori- zontal			
CBRC-11-1	1:1	Minimal (50 psi)	NO	NO	Solid	Shear	D
" -2	"	"	1 - #5 (Totl. 2 - #5)	"	"	"	"
" -3	"	"	"	1 - #5	"	"	"
" -4	"	"	"	5 - #5	"	Flexure	"
" -5	"	"	1 - #8 (Totl. 2 - #8)	NO	"	Shear	"
" -6	"	"	"	2 - #5	"	"	"
" -7	"	"	"	5 - #6	"	Flexure	"
CBRC-21-1	2:1	"	NO	NO	"	Shear	"
" -2	"	"	1 - #5 (Totl. 2 - #5)	"	"	"	"
" -3	"	"	"	1 - #5	"	Shear & Flexure	"
" -4	"	"	"	5 - #5	"	Flexure	"
CBRC-12-1	1:2	"	NO	NO	"	Shear	"
" -2	"	"	1 - #5 (Totl. 3 - #5)	"	"	"	"
" -3	"	"	"	2 - #5	"	"	"
" -4	"	"	"	5 - #6	"	Flexure	"
" -5	"	"	1 - #7 (Totl. 3 - #7)	3 - #6	"	Shear	"

TABLE 4: HOLLOW CONCRETE BLOCK WALLS (HCBL) (See Figs. 11-12)

Unit W:L:H = 8" x 16" x 8"

Name of Tests	H/D Ratio	Bearing Load (kips)	Reinforcement		Grouting F: fully P: partial	Expected Failure Mode	Loading Rate s: static d: dynamic
			Vertical	Horizontal			
HCBL-11-1	1:1	Minimal (50 psi)	NO	NO	F	Shear	D
" -2	"	"	"	"	P	"	"
" -3	"	"	1 - #5 (Totl. 2 - #5)	"	F	"	"
" -4	"	"	"	1 - #5	F	"	"
" -5	"	"	"	"	P	"	"
" -6	"	"	"	4 - #5	F	Flexure	"
" -7	"	"	1 - #8 (Totl. 2 - #8)	NO	"	Shear	"
" -8	"	"	"	"	P	"	"
" -9	"	"	"	2 - #5	F	"	"
" -10	"	"	"	"	P	"	"
" -11	"	"	"	4 - #6	F	Flexure	"
HCBL-12-1	1:2	"	NO	NO	F	Shear	"
" -2	"	"	1 - #5 (Totl. 3 - #5)	"	"	"	"
" -3	"	"	"	2 - #5	"	"	"
" -4	"	"	"	4 - #6	"	Flexure	"
" -5	"	"	1 - #7 (Totl. 3 - #7)	3 - #6	"	Shear	"

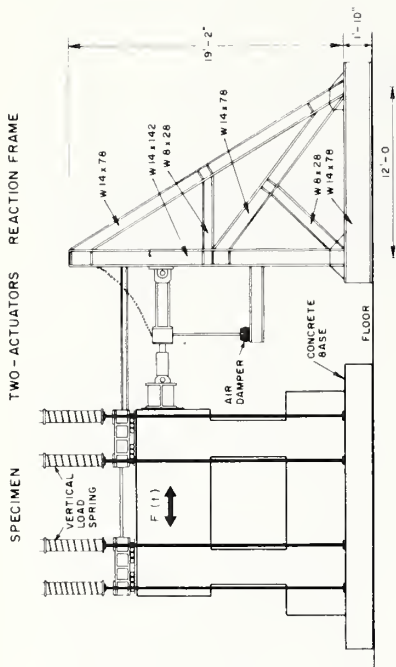

FIGURE 2 DOUBLE PIER TEST SET-UP

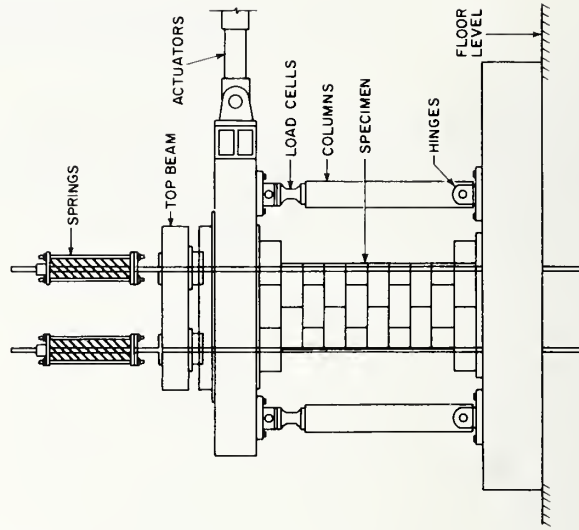

FIGURE 4 SINGLE PIER TEST SET-UP

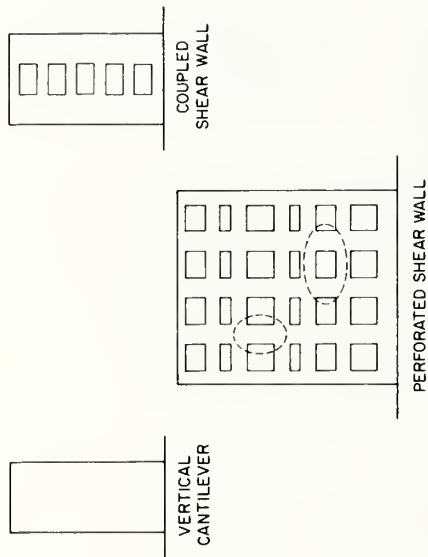

FIGURE 1 TYPICAL SHEAR WALLS

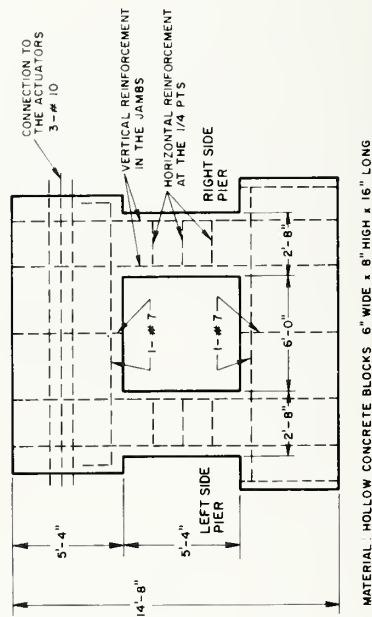

FIGURE 3 TYPICAL DOUBLE PIER TEST SPECIMEN

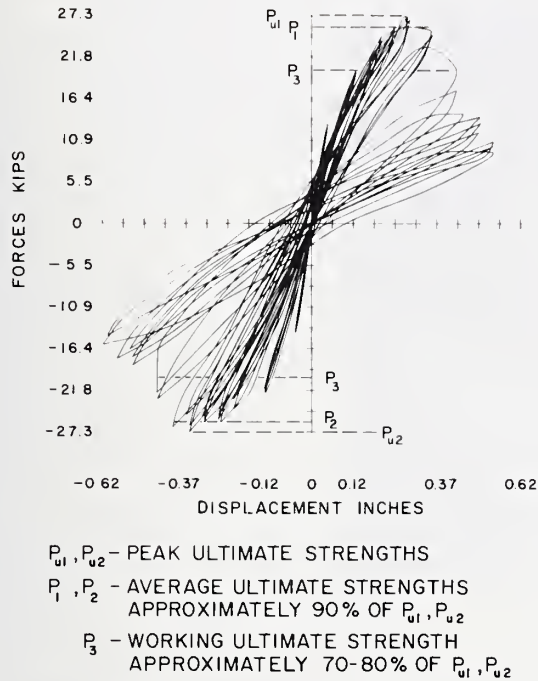

FIGURE 5 DEFINITION OF ULTIMATE STRENGTH

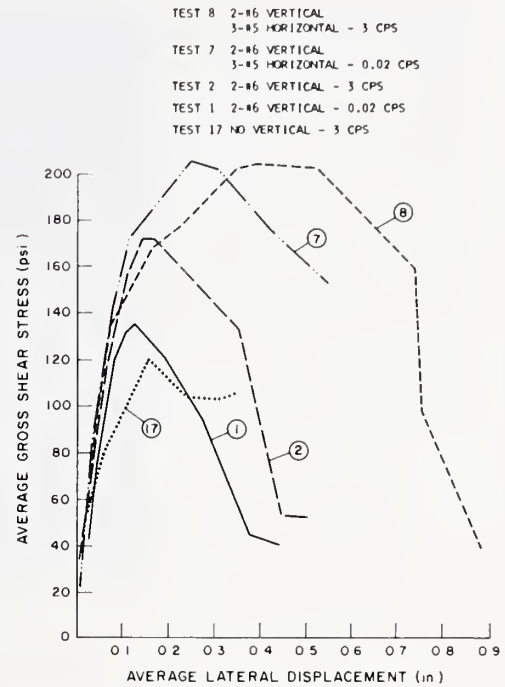

FIGURE 7 HYSTERESIS ENVELOPE (EFFECT OF REINFORCEMENT)

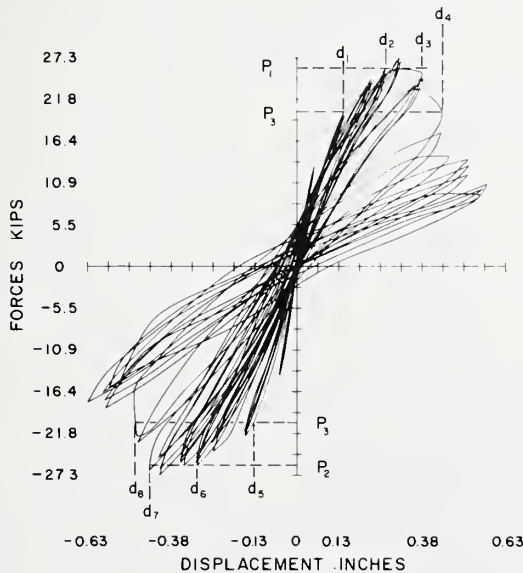

FIGURE 6 DEFINITION OF DUCTILITY INDICATORS

DUCTILITY INDICATORS

(1) AT AVERAGE ULTIMATE STRENGTH - P_1, P_2

$$\delta_1 = \frac{d_3}{d_2} \quad \delta_2 = \frac{d_7}{d_6}$$

VARIED BETWEEN
1.45 — 5.1

(2) AT WORKING ULTIMATE STRENGTH - P_3

$$\delta_3 = \frac{d_4}{d_1} \quad \delta_4 = \frac{d_8}{d_5}$$

VARIED BETWEEN
2.4 — 8.1

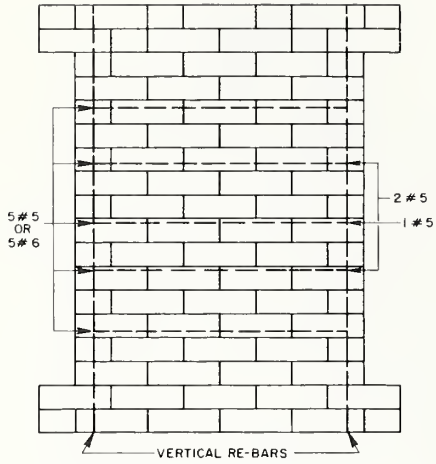

REINFORCEMENT DETAILS OF HOLLOW CLAY AND GROUTED CORE BRICK WALLS - 4'-8" x 4'-0"

FIGURE 8

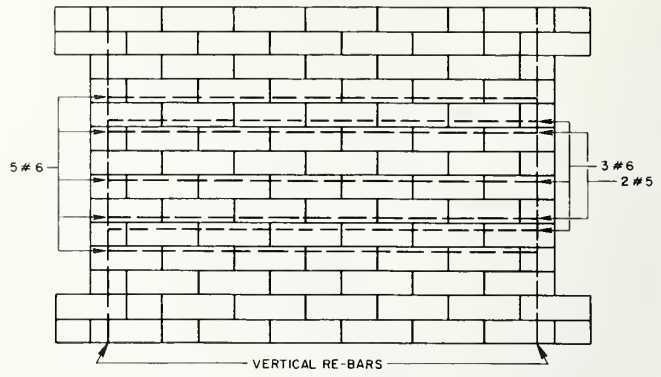

REINFORCEMENT DETAILS OF HOLLOW CLAY AND GROUTED CORE BRICK WALLS - 3'-4" x 6'-6"

FIGURE 10

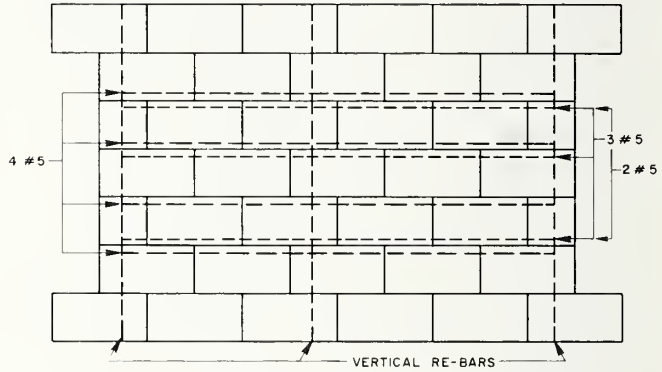

REINFORCEMENT DETAILS FOR HOLLOW CONCRETE BLOCK WALLS - 3'-4" x 6' x 8"

FIGURE 11

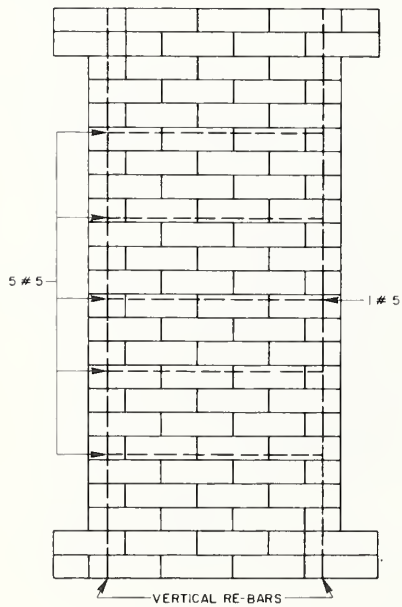

REINFORCEMENT DETAILS OF HOLLOW CLAY AND GROUTED CORE BRICK WALLS - 6'-8" x 3'-6"

FIGURE 9

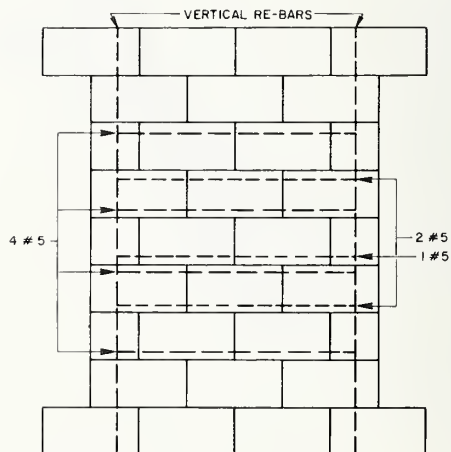

REINFORCEMENT DETAILS FOR HOLLOW CONCRETE BLOCK WALLS - 4'-8" x 4'-0"

FIGURE 12

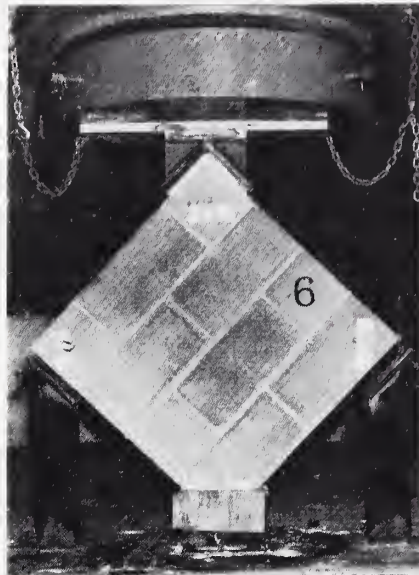

FIGURE 13 DIAGONAL TEST SET-UP

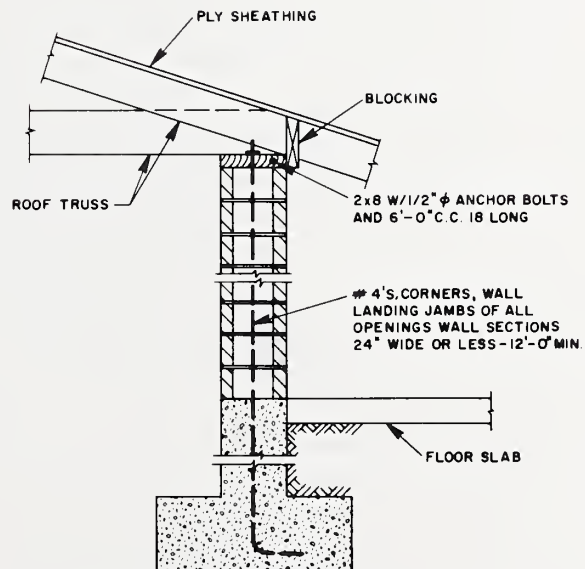

FIGURE 14 CONNECTION DETAILS OF A SLOPING ROOF

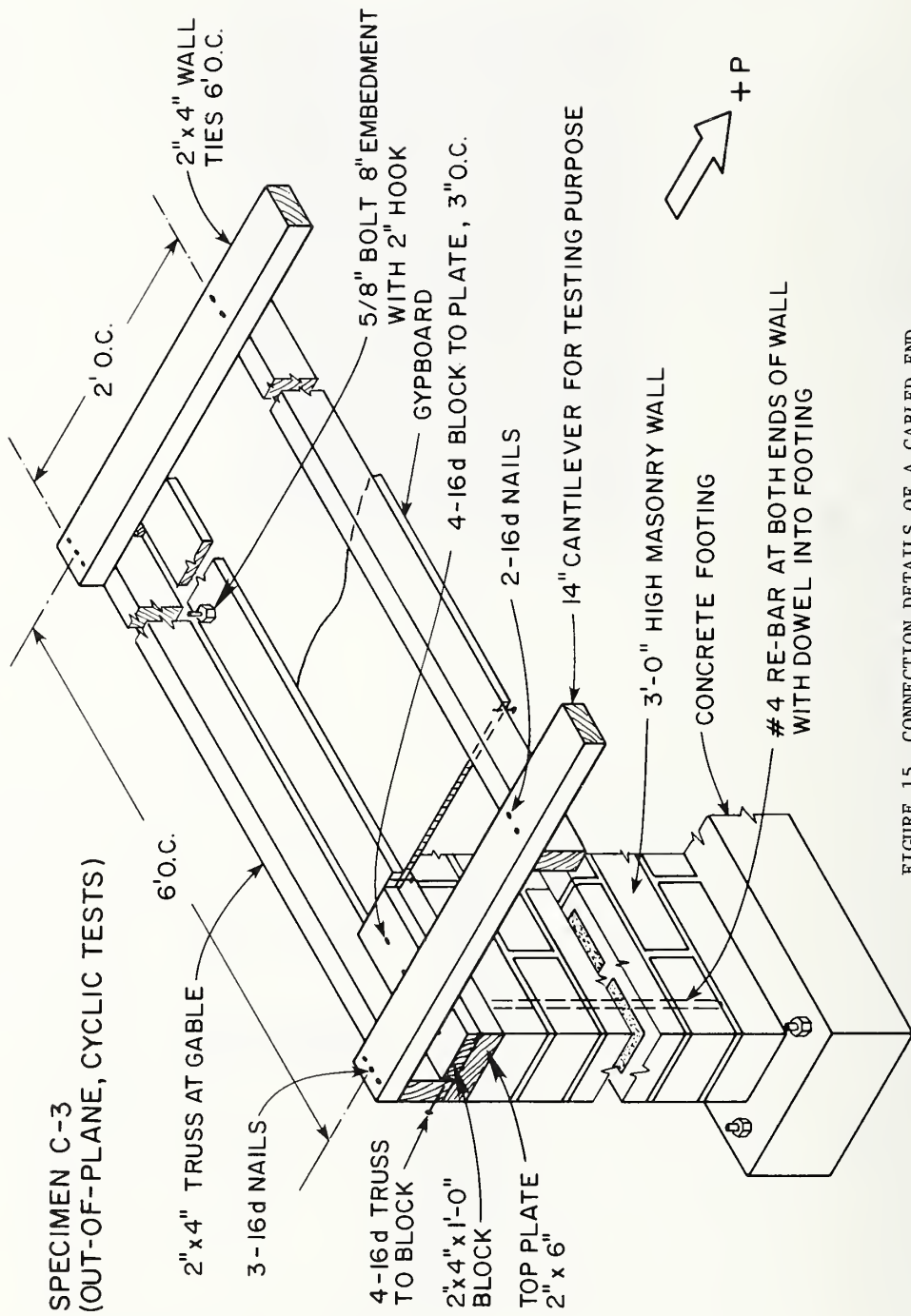

FIGURE 15 CONNECTION DETAILS OF A GABLED END

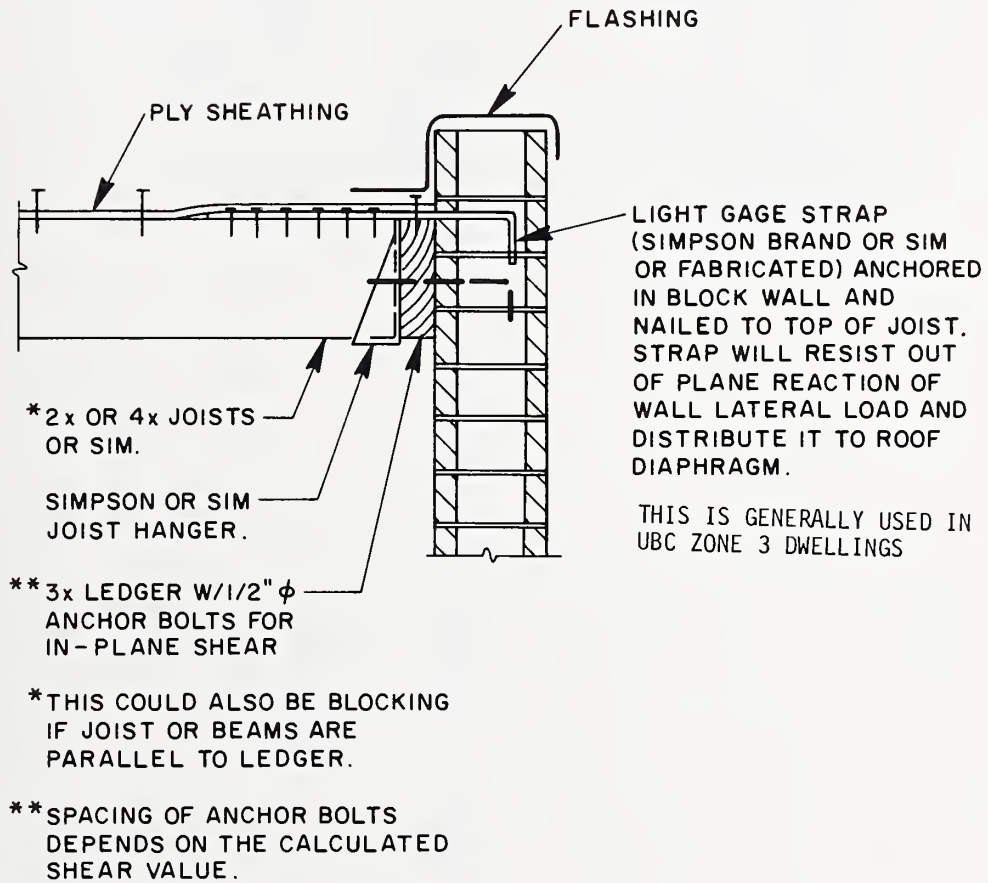

FIGURE 16 CONNECTION FOR FLAT ROOF

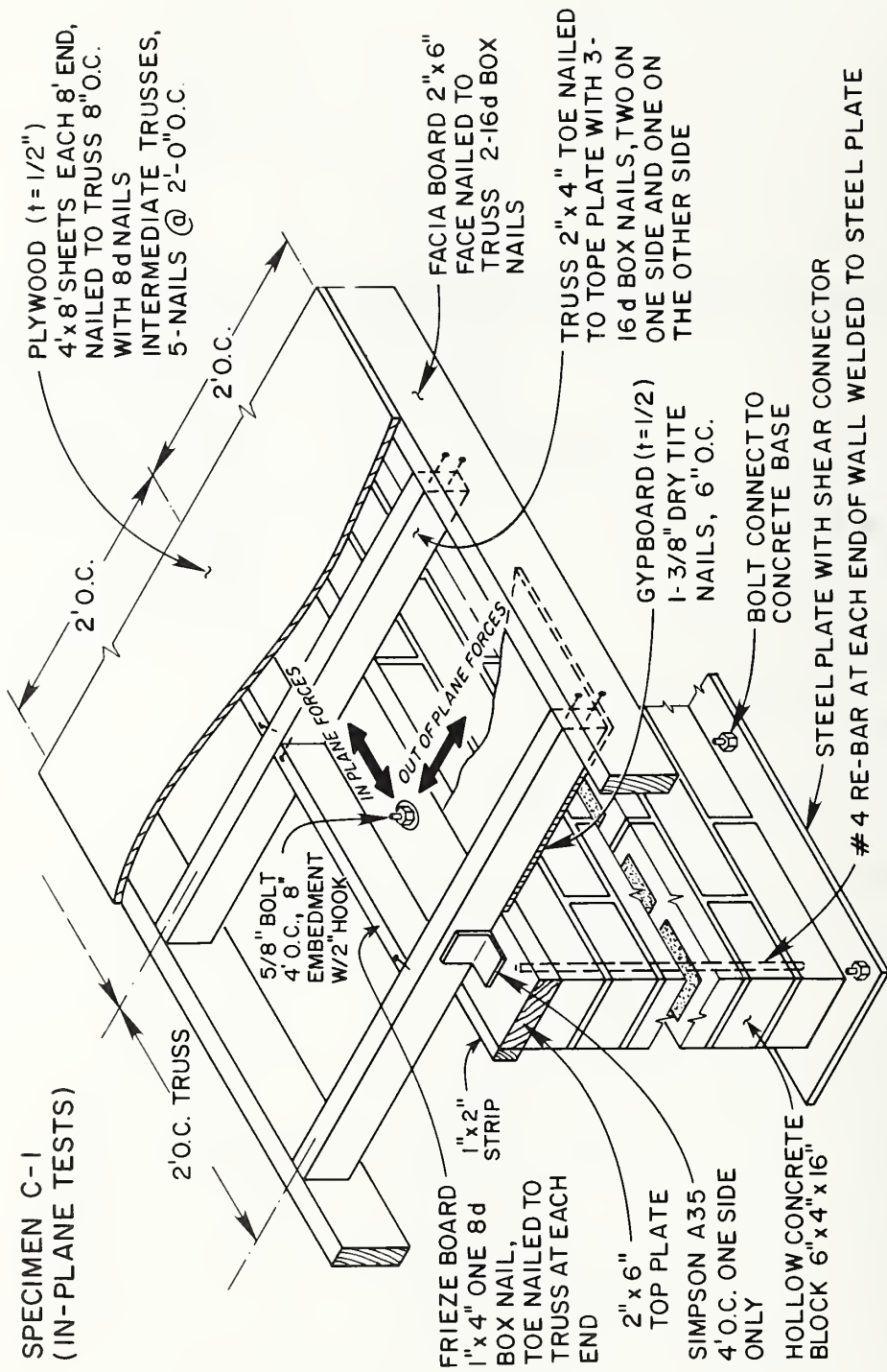

FIGURE 17 TEST SPECIMEN FOR TOP PLATE BOLT TESTS

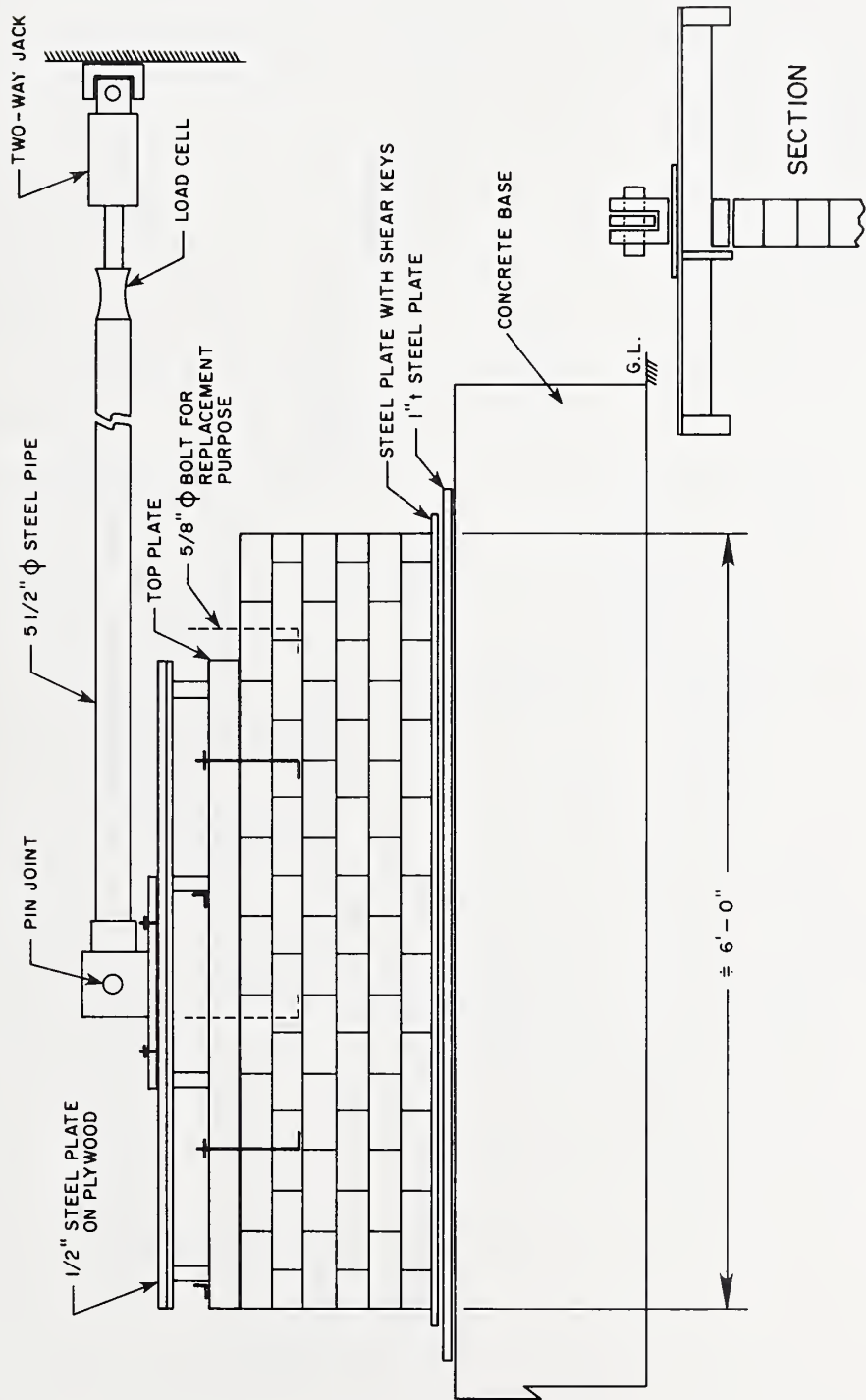

FIGURE 18 IN PLANE TEST SET-UP

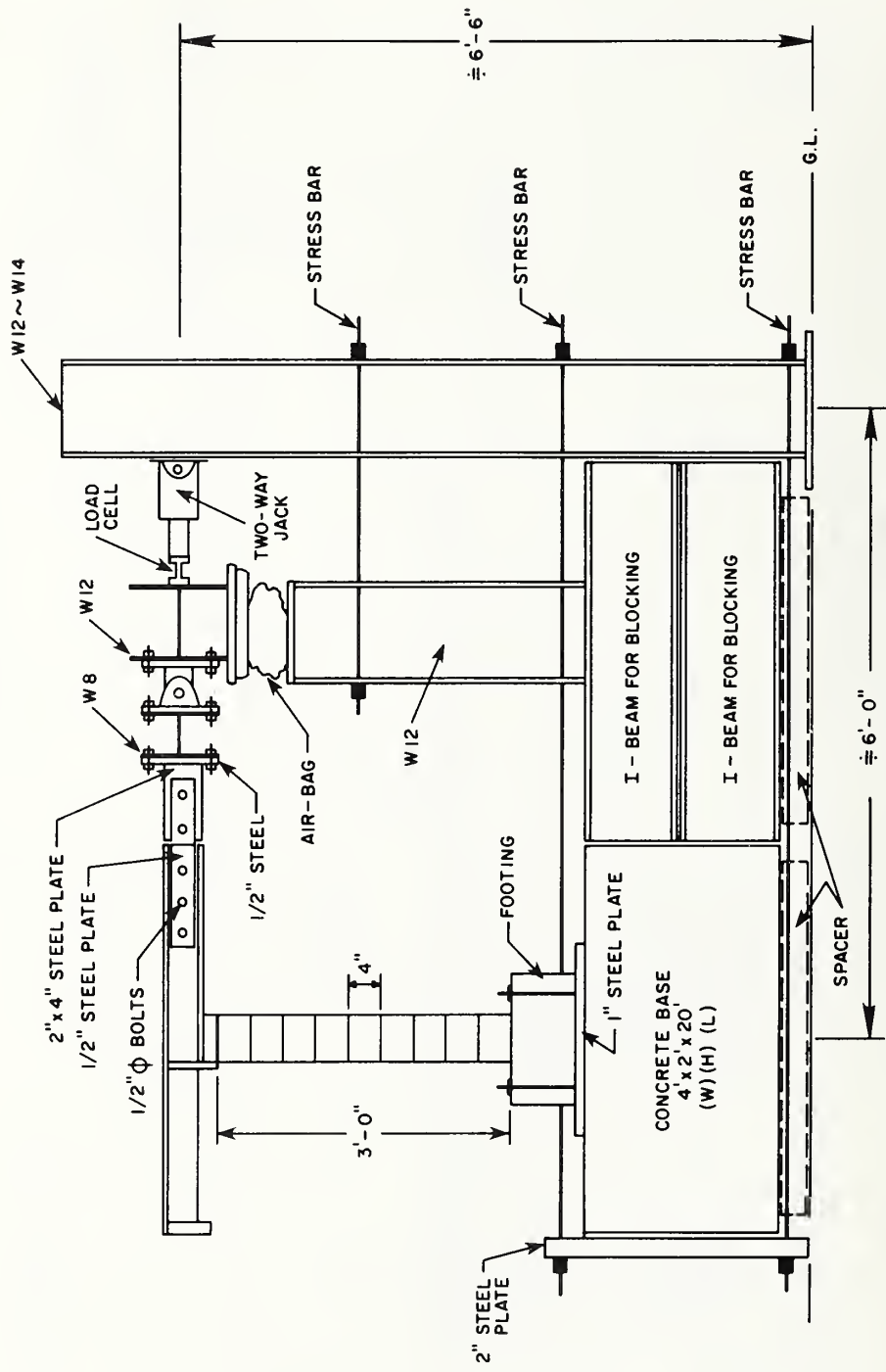
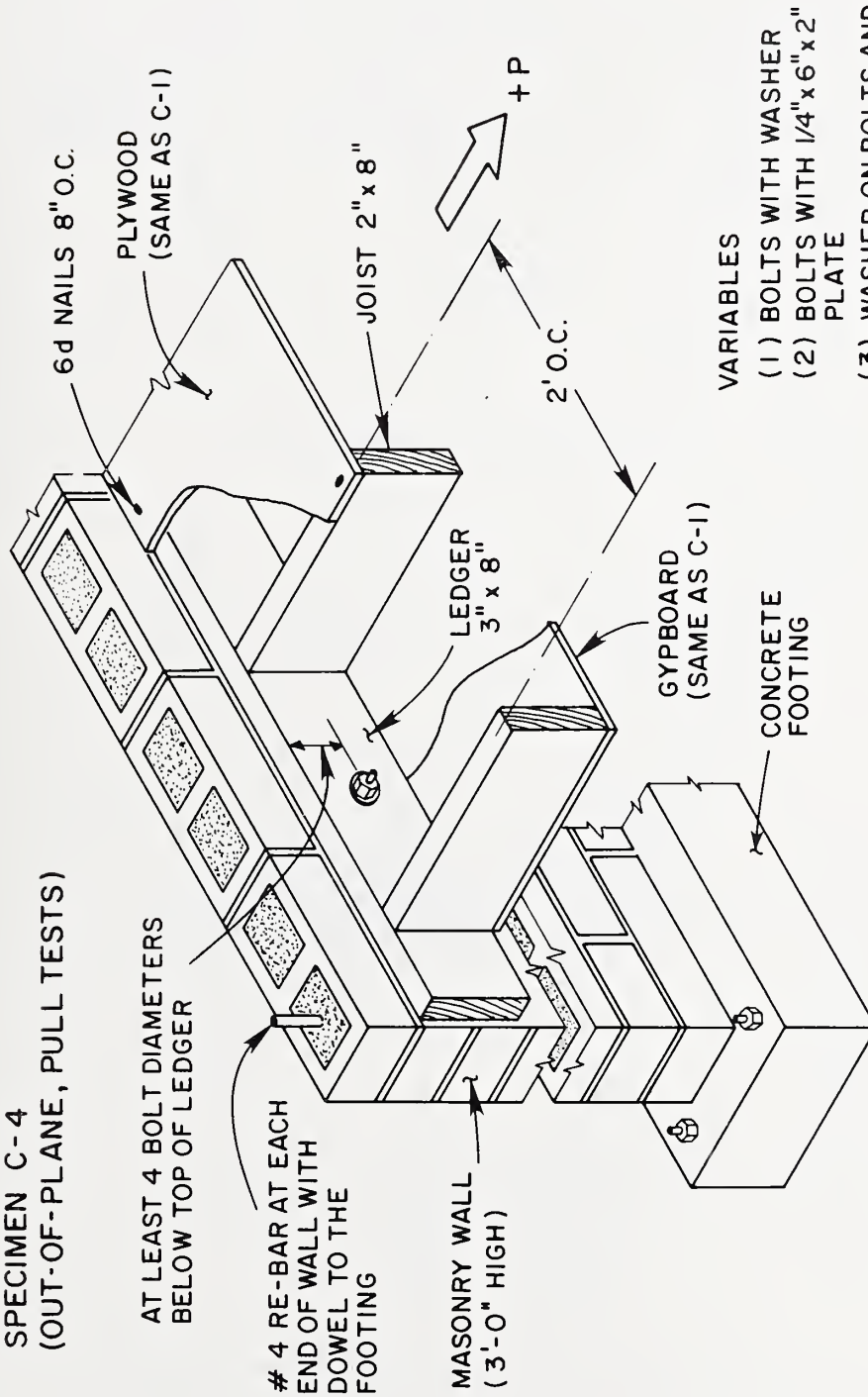

FIGURE 19 OUT OF PLANE TEST SET-UP

**SPECIMEN C-4
(OUT-OF-PLANE, PULL TESTS)**



VARIABLES

- (1) BOLTS WITH WASHER
- (2) BOLTS WITH 1/4" x 6" x 2" PLATE
- (3) WASHER ON BOLTS AND SIMPSON STRAPS

FIGURE 20 TEST SPECIMEN FOR FLAT ROOF CONNECTION TESTS

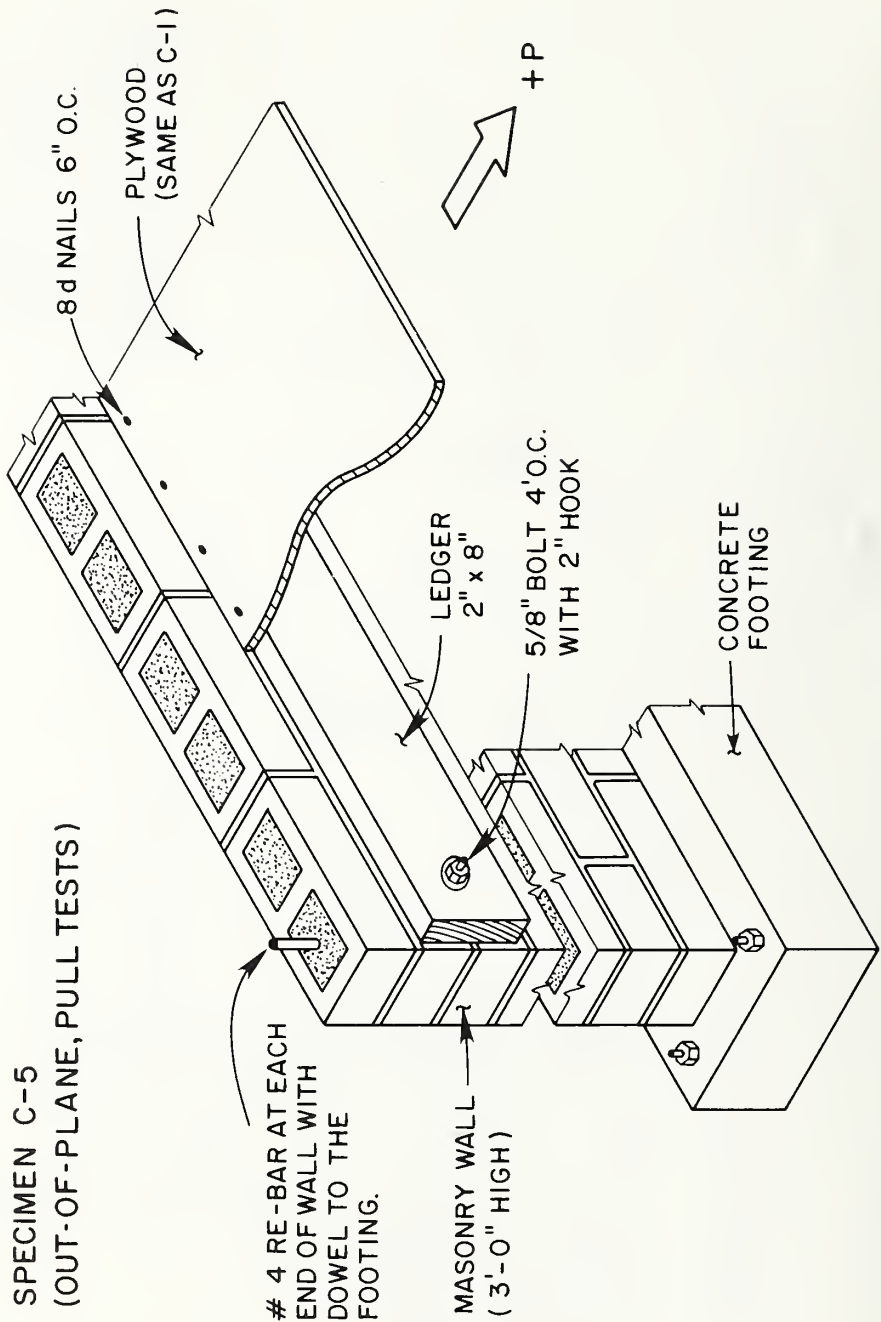

FIGURE 21 TEST SPECIMEN FOR FLAT ROOF CONNECTION TESTS

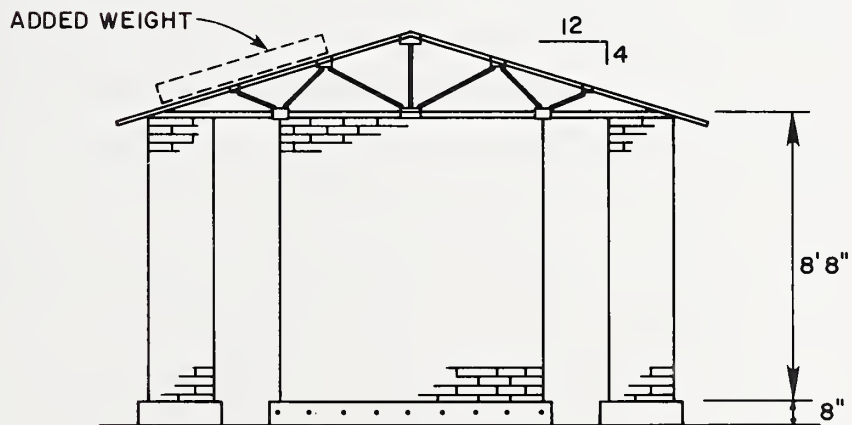
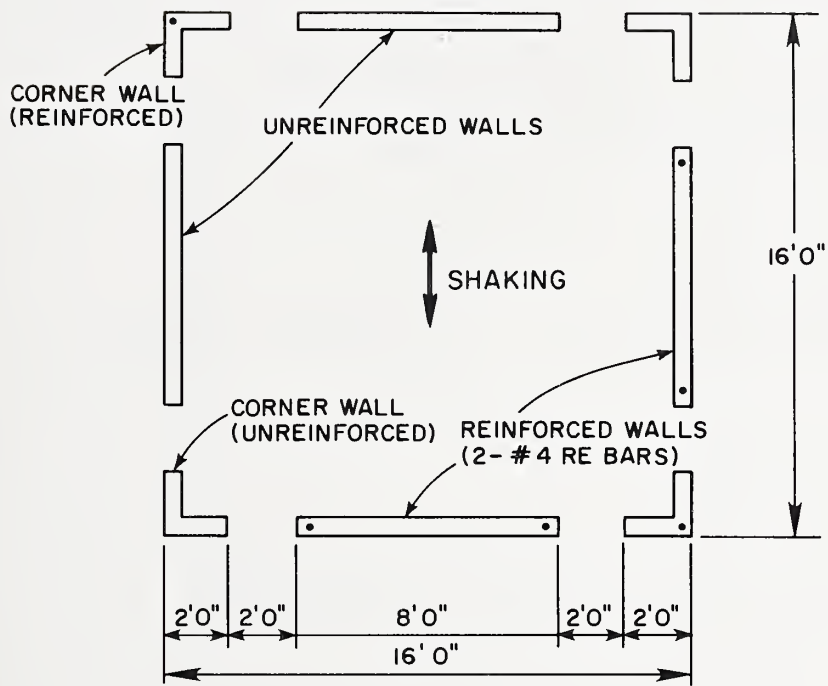

FIGURE 22 TEST SPECIMEN FOR THE FIRST SHAKING TABLE TEST

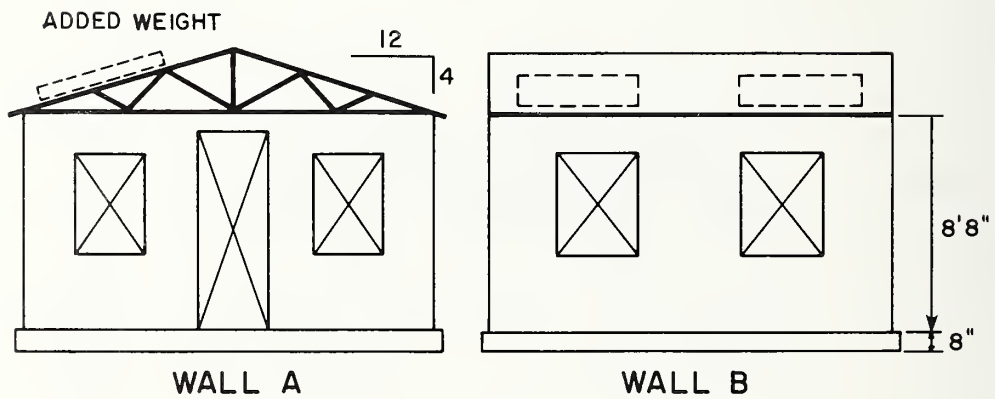
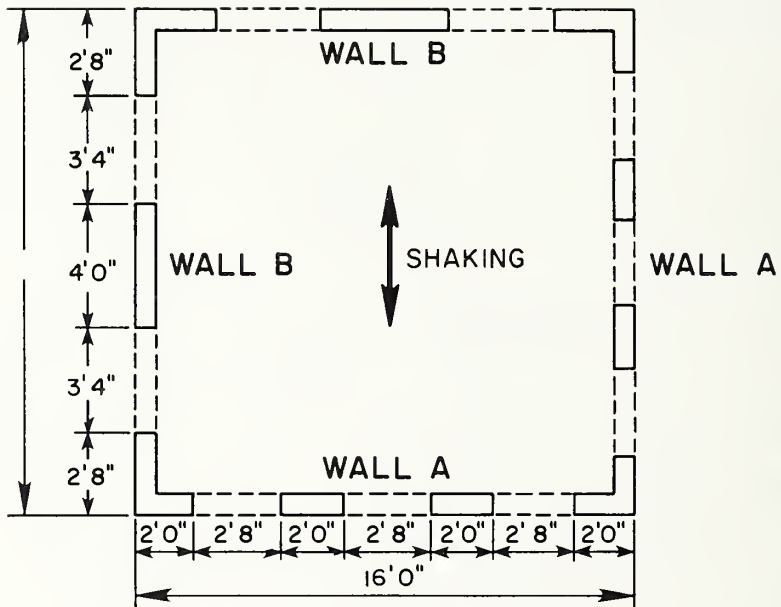

FIGURE 23 TEST SPECIMEN FOR THE FINAL SHAKING TABLE TEST

EXPECTED PERFORMANCE OF UNIFORM BUILDING CODE
DESIGNED MASONRY BUILDINGS

Ronald L. Mayes^(I), Ray W. Clough^(II), Yutaro Omote^(III),
and Shy-Wen Chen^(IV)

The paper presents a summary of a study on the evaluation of the seismic design sections of the 1972, 1973, 1974 and 1976 Uniform Building Codes, and the recommended Comprehensive Seismic Design Provisions for Buildings prepared by the Applied Technology Council (ATC-3). In order to evaluate the various codes a three, a nine and a seventeen story building of similar floor plan were studied. The seismic design stresses were calculated in these buildings by the specific code procedures as well as the stress state predicted by a realistic dynamic earthquake response procedure. The adequacy of the codes was then evaluated by comparison of the two types of stress predictions.

The conclusion of the study was that the increasing conservatism of the more recent codes is justified and that greater conservatism is necessary in the most recent codes in buildings of moderate height, such as the nine and seventeen story buildings considered in this study.

Key Words: Masonry; shear walls; codes; dynamic analysis; design.

I - Assistant Research Engineer, University of California, Berkeley;
Principal, Computech, Berkeley.

II - Professor, Structural Engineering, University of California, Berkeley.

III - Assistant Research Engineer, University of California, Berkeley.

IV - Research Assistant, University of California, Berkeley.

1. INTRODUCTION

One of the most difficult tasks facing structural engineers today is prediction of the performance of a structure during an earthquake. The problem is compounded with respect to masonry structures because of a lack of experimental data on the performance of masonry structural components. For this reason it is imperative that significant research data are utilized as they become available, to improve the reliability of masonry construction by continually updating the building codes.

The problem of utilizing new research data in evaluating design code requirements is difficult and requires cooperation of research personnel, practicing structural engineers, soils engineers, and seismologists because many facets of earthquake engineering are involved. The first significant attempt to evaluate the expected seismic performance of code designed masonry structures was performed by Young et al⁽¹⁾. They reported the results of a study on the predicted behavior of two reinforced concrete masonry multi-story (11 and 13 stories) buildings when subjected to specified earthquake ground motions. The purpose of the study was to determine whether these structures would experience severe damage if subjected to earthquake ground motion of an intensity consistent with that which could reasonably be expected to occur during the planned life of the structures. The authors concluded that the buildings would be severely damaged and would probably collapse if subjected to the ground motion considered in the report.

A more recent and broader contribution was made in 1974 with the publication of the Applied Technology Council (ATC-2) report⁽²⁾ entitled "An Evaluation of a Response Spectrum Approach to Seismic Design of Buildings." The report addressed the problem "Given response spectra representative of damage-threshold and collapse-threshold earthquake ground motions at a given site,

what design procedures should be employed to ensure a given structure an acceptable degree of reliability in protection against damage and prevention of collapse?". The study selected ground motions that were representative of certain sites in Southern California and adopted design procedures based on a response spectrum approach. Eleven existing buildings were chosen for redesign according to these procedures. Included in the study were a three-story and a one-story masonry shear wall building.

The major problem involved in any evaluation of building code requirements is to define an acceptable starting point (i.e., input ground motions or response spectra) and a suitable procedure for evaluating the safety of a given structure. The adequacy of these two definitions will determine the reliability of the evaluation.

Because of time and budget restraints, the scope of the study reported herein is limited to an evaluation of changes that have occurred recently in the seismic section of the masonry portion of the Uniform Building Code (UBC) ⁽³⁾ and in the proposed new ATC-3 seismic code ⁽⁴⁾, utilizing the response spectra defined in the ATC-2 report and the results of a State-of-the-Art report on the shear strength of masonry construction performed by the writers ⁽⁵⁾. Within these constraints the writers envisage this study to be the first part of a continuing effort to utilize relevant research data in evaluating masonry design codes.

1.1 Background and Objective of the Study

Because of the continuing lack of relevant research information on masonry structural assemblages and the associated uncertainty in the seismic behavior of masonry structural components, the UBC masonry seismic design section has been changed substantially several times in the past five years. Although the code allowable shear stresses for seismic loads have remained essentially

unchanged (see Table 1), the effective seismic design coefficients have undergone considerable changes, as shown in Fig. 1.

The UBC static method of obtaining the seismic design shear stresses is to calculate the base shear V from the formula

$$V = ZKCW \quad , \quad (1)$$

where Z is a numerical coefficient related to the seismicity of the region, K equals 1.33 for masonry shear wall buildings, W is the total weight of the building and C is the seismic base shear coefficient. According to the 1972 Uniform Building Code, this coefficient is given by

$$C = \frac{0.05}{\sqrt[3]{T}} \quad , \quad (2)$$

where T is the fundamental vibration period of the building; but in the 1976 code it has been changed to

$$C = \frac{1}{1.5\sqrt{T}} \quad . \quad (3)$$

Moreover in the 1976 UBC, equation (1) has been changed to include a site-structure resonance coefficient, S .

In both editions of the code, the base shear force V is distributed over the height of the building according to the formula

$$F_x = \frac{h_x w_x}{\sum_i h_i w_i} V \quad , \quad (4)$$

where F_x is the lateral force applied to level "x", h_i or h_x is the height in feet above the base to level "i" or "x", and w_i or w_x is the portion of W which is located at level "i" or "x". The seismic design stresses are then obtained by performing a static analysis of the structure subjected to this force distribution.

In the 1972 UBC, the effective value of C is as shown in curve 1 of Fig. 1. In the 1973 UBC, a footnote to Table 24-H "Maximum Working Stresses for Reinforced Solid Hollow Unit Masonry," requires that the shear stresses

obtained from seismic loads be doubled for design purposes, and in the 1974 code this factor of two is reduced to 1.5. Thus, the seismic loads are effectively increased (for shear stresses but not for overturning moments) by a factor of 2 in the 1973 code and by 1.5 in the 1974 code. These changes of C are shown by curves 2 and 3 in Fig. 1. In the 1976 UBC, the factor C is replaced by C_s. The factor of 1.5 still remains as a footnote to Table 24-H and the effective design spectrum obtained for the maximum value of the site-structure interaction factors S is shown as curve 4 in Fig. 1. The effective design spectrum for the ATC-3 proposed seismic design code is shown as curve 5, based on the maximum acceleration value of 0.4g specified for Seismic Zone 4 and with

$$C_s = \frac{1.2A_2S}{RT_R^{2/3}} \quad (5)$$

where C_s is the seismic design coefficient, A₂ is a coefficient representing effective peak ground acceleration, S is the coefficient representing the soil profile, R is the response modification factor and equals 4 for masonry buildings, and T_R is a structural response coefficient related to the fundamental period.

It is clear from Fig. 1 that there has been considerable uncertainty in the past five years as to an appropriate design spectrum for masonry shear wall structures. Consequently the objective of this study was to attempt to evaluate these and other recent code provisions for masonry seismic design. This effort was undertaken after the masonry research program at Berkeley had been in progress for several years, and was in response to a question that has been asked repeatedly: "In the light of your research results, should code allowable shear stresses in masonry remain the same, be increased, or decreased?"

In order to evaluate various changes that have been introduced in the effective design spectra of recent and proposed building codes, three masonry

buildings were studied. The seismic design stresses were calculated in these buildings by the specified code procedures as well as the stress state predicted by a realistic dynamic earthquake response procedure. The adequacy of the codes was then evaluated by comparison of the two types of stress prediction.

The general approach used in the procedure is outlined. The detailed set of results can be obtained from reference (6).

2. EVALUATION PROCEDURE

2.1 Selection of Buildings

Three buildings with identical reasonably symmetric floor plans and which have vertical shear walls with openings similar to those found in many multi-story masonry buildings were selected for the study, Figs. 2, 3 and 4. They were three, nine, and seventeen stories high, respectively. Data for the buildings were obtained from the design example presented in "Multistory Load Bearing Brick Walls," a publication of the Brick Institute of California⁽⁷⁾. The buildings were designed originally according to the 1968 Uniform Building Code.

2.2 Code Seismic Design Stresses

The calculated seismic design stresses resulting from the earthquake loads specified by the 1972 UBC, 1973 UBC, 1974 UBC, 1976 UBC and the proposed ATC-3 Code for Zone 3 (Zone 4 after 1974) were obtained by performing an equivalent first mode static analysis of the buildings using the computer program ETABS⁽⁸⁾. The seismic design shear stresses and the design vertical stresses resulting from overturning and dead load were calculated for each wall panel of the lower level of the building.

2.3 Design Factor of Safety

With respect to the shear stresses resulting from the code seismic loads, the design factor of safety, designated A, was evaluated as the ratio

$$A = \frac{\text{Code allowable shear stress}}{\text{Code calculated seismic shear stress}} \quad (6)$$

where the denominator is the shear stress described above, the numerator is specified by each code.

It is clear that the minimum permissible value of A is 1.0 and the higher the value of A the greater the design factor of safety. A value of A greater than 1.0 may result from including either a larger number of shear walls or greater wall thicknesses than might be required.

2.4 Stresses Resulting from a Realistic Earthquake

The stresses determined by application of the response spectrum specified in the ATC-2 report⁽²⁾ were evaluated for each of the three buildings. This spectrum represents an earthquake having about a 50% probability of being exceeded in 70 years. It was developed for a typical site in the Los Angeles area and is based on an inelastic response spectrum concept. The spectrum chosen was the Damage Threshold Spectrum for Strength Determination, with a ductility factor of 1.5 and a damping value of 5%. Each building was analyzed for its response to this input by the method of mode superposition, using the computer program ETABS⁽⁸⁾. The shear and vertical normal stresses resulting from the realistic spectrum were calculated for each of the lower level panels.

2.5 Simplified Failure Criteria

Although investigations are currently in progress to determine a realistic failure criterion for masonry structural elements, it was necessary for the purpose of this study to define a simplified failure criterion in order that the work might proceed. Failure was assumed to depend on the maximum tensile

stress developed in the shear wall panels. The stress distribution acting on the top and bottom sections of a typical lower level panel is shown in Fig. 5. The normal and shear force acting on the panel due to dead load and the response spectrum analysis were determined first; then the resulting stress distribution was defined by elementary beam theory. Thus the vertical normal stress was assumed to vary linearly across the panel, and the shear stress to be distributed parabolically, as shown in the figure. The maximum tensile stress was assumed to occur at the center of the panel, point A, and was calculated by means of Mohr's circle to be

$$\sigma_t = \sqrt{(1.5\tau)^2 + (\sigma_c/2)^2} - \sigma_c/2 \quad (7)$$

where σ_c and 1.5τ represent the normal and shear stress on a horizontal section at this point.

2.6 Expected Performance Based on Strength Measurements

In order to evaluate the expected performance of the three buildings when subjected to the realistic earthquake, a critical tensile strength for the lower level panels was evaluated from available test data. Since no tests have been performed on test specimens of the size of the lower level panels, data obtained on other types of test panels were used. To ensure a conservative evaluation, the lower bound of the available test data was defined as the critical tensile strength (Table 2).

The expected performance of the buildings was then expressed by the ratio B, representing the expected factor of safety and defined as

$$B = \frac{\text{Critical tensile strength}}{\text{Calculated principal tensile stress}} \quad (8)$$

A value of B greater than 1.0 indicates that a panel would perform adequately during the expected earthquake, while a value significantly less

than 1.0 would postulate failure of that particular panel.

2.7 Evaluation of the Codes

Although the ratios A and B, given by Equations 6 and 8, represent the design factor of safety and the expected actual performance of a particular building subjected to a realistic earthquake, they cannot, when considered separately, be used to evaluate the various codes. This is because the value of A, shown in Section 2.3 varies for each code for a given building design. The ratio B, considered separately, indicates the adequacy of a given code only when the ratio A is the same for all codes. However, the ratio B/A provides a direct measure of a code's suitability. If B/A is greater than 1.0 the code may be considered adequate, but if B/A is less than 1.0 the code may be assumed to provide inadequate protection against severe damage or collapse during a particular earthquake.

3. DISCUSSION OF RESULTS

A summary of the B/A ratios is included in Table 3 which shows that the ratios B/A for all interior lower level panels of the nine and seventeen story buildings are less than one for the 72, 73, 74 and 76 Uniform Building Codes and the proposed ATC-3 Codes. This indicates that none of these codes provide adequate protection against damage to these buildings from the realistic earthquake considered in this study.

The values of B/A for the three story building in the 76 UBC and proposed ATC-3 Code are greater than one for three of the six interior lower level panels and less than one for the other three. This suggests that within the limits of this study the 76 UBC and proposed ATC-3 Code provide reasonable protection against severe damage in low masonry buildings.

In the proposed ATC-3 Code the code allowable stresses of Table 9A are multiplied by 2.5ϕ where ϕ is 0.6 provided horizontal reinforcement carries all the shear. If ϕ were reduced to 0.3 the values of B/A for three of the six interior lower level panels would be greater than one and less than one for the other three. This suggests that if this change were made the proposed ATC-3 code would provide reasonable protection against severe damage in masonry buildings of moderate height.

Although the study considered the effect of a realistic earthquake occurring in a highly active seismic region, inferences for less seismically active regions can be drawn from these results. For example, in Seismic Zone 2 of the Uniform Building Code the zone factor Z equals 0.5. The consequence of this reduction in design loads is an increase in the ratio A by a factor of 2 because the strength of the structure is not changed. Although a representative response spectrum for a typical site in Seismic Zone 2 was not considered in this study, it is expected that it would define significantly lower seismic loads than those from the spectrum obtained from the ATC-2 study which was used here to calculate the ratio B. If a representative spectrum for Zone 2 gave seismic coefficients approximately half those of the ATC-2 spectrum, then the ratio B would be increased by a factor of approximately 2.0. In this case, the increase in both A and B would cancel when the ratio B/A is calculated. Consequently, the values of B/A which are presented in Table 3 for the most active seismic regions in the codes also may be indicative of results that would be obtained for regions of lower seismic activity. To obtain a more refined calculation of B/A for other seismic zones, a representative spectrum for a typical site would be required, but the preceding discussion shows qualitatively the general applicability of the inferences drawn in this study.

In conclusion, it is apparent that the trend towards increasing conservatism which is evidenced in recent code changes concerning masonry structures is

justified. Moreover, the study suggests that the codes should be more conservative for masonry buildings of moderate height.

4. REFERENCES

1. Young, G.A., et al. "Response of Two Multistory Reinforced Concrete Masonry Buildings to Earthquake Ground Motion." Agbabian Associates, Los Angeles, California, August 1972.
2. "An Evaluation of a Response Spectrum Approach to Seismic Design of Buildings," Applied Technology Council - Report No.2, San Francisco, California, 1974.
3. Uniform Building Code, 1973 Edition, Published by the International Conference of Building Officials, Whittier, California, 1973.
4. "Working Draft of Recommended Comprehensive Seismic Design Provisions for Buildings," Applied Technology Council, San Francisco, California, January 31, 1976.
5. Mayes, R.L. and Clough, R.W., "State-of-the-Art in Seismic Strength of Masonry - An Evaluation and Review," University of California, Berkeley, California, EERC Report No. 75-21, 1975.
6. Mayes, R.L., Omote, Y., Chen, S.-W. and Clough, R.W., "Expected Performance of Uniform Building Code Designed Masonry Structures," University of California, Berkeley, California, EERC Report No. 76-7, September 1976.
7. Dickey, W.L., "Multi-Story Load Bearing Brick Walls," Brick Institute of California, October 1968.
8. Wilson, E.L., et al. "Three Dimensional Analysis of Building Systems-(Extended Version)," University of California, Berkeley, California, EERC Report No. 75-13, April 1975.
9. Blume, J.A. and Proulx, J., "Shear in Grouted Brick Masonry Wall Elements," Western States Clay Products Association, San Francisco, California, Copyright 1968.
10. Borchelt, J.G., "Analysis of Brick Walls Subject to Axial Compression and In-Plane Shear," Proceedings of Second International Brick Masonry Conference, Stoke-on-Trent, April 1970.
11. Williams, D., "Seismic Behaviour of Reinforced Masonry Shear Walls," Ph.D. Thesis, University of Canterbury, New Zealand, 1971.
12. Priestley, M.J.N. and Bridgeman, D.O., "Seismic Resistance of Brick Masonry Walls," Bulletin of the New Zealand National Society for Earthquake Engineering, Vol. 7, No. 4, December 1974.

TABLE 1. MAXIMUM ALLOWABLE SHEAR STRESSES
FOR SEISMIC LOADS

Code	Reinforcement Taking All the Shear	
	$M/V_d > 1$ (psi)	$M/V_d = 0$ (psi)
72-UBC	100	100
73-UBC	100	160
74-UBC	100	160
76-UBC	100	160
ATC-3	112	180

TABLE 2. RANGE OF CRITICAL TENSILE STRENGTHS

DIAGONAL COMPRESSIVE TESTS

	BORCHELTS FORMULATION		BLUMES FORMULATION	
	LOWER BOUND	UPPER BOUND	LOWER BOUND	UPPER BOUND
DOUBLE WYTHE GROUTED BLUME (9)	175	425	130	210
SINGLE WYTHE SOLID BRICK BORCHELT (10)	175	620	85	410
HOLLOW CLAY BRICK BLUME (9)	125	390	90	290

RACKING TESTS

	UNIFORM SHEAR DISTRIBUTION		PARABOLIC SHEAR DISTRIBUTION	
DOUBLE WYTHE GROUTED PRIESTLEY (12)	100	110	150	190
HOLLOW CLAY BRICK WILLIAMS (11)	70	140	130	250
CONCRETE BLOCK MAYES AND CLOUGH (5)	80	180	130	230

All values are based on the net area.

TABLE 3. CODE EVALUATION RATIO B/A (Based on the lowest level shear panels)

CODE	B/A (3-story)					B/A (9-story)					B/A (17-story)				
	P-2*	P-3	P-11	P-12		P-2	P-3	P-11	P-12		P-2	P-3	P-11	P-12	
72 UBC	0.68	0.56	0.57	0.90		0.28	0.18	0.18	0.30		0.31	0.17	0.15	0.27	
73 UBC	0.93	0.76	0.77	1.23		0.38	0.24	0.24	0.41		0.43	0.23	0.27	0.37	
74 UBC	0.70	0.57	0.58	0.92		0.28	0.18	0.18	0.31		0.32	0.17	0.16	0.28	
76 UBC	1.08	0.87	0.90	1.44		0.63	0.40	0.40	0.68		0.65	0.35	0.32	0.57	
ATC-3	1.04	0.84	0.86	1.37		0.59	0.38	0.38	0.65		0.70	0.38	0.35	0.61	

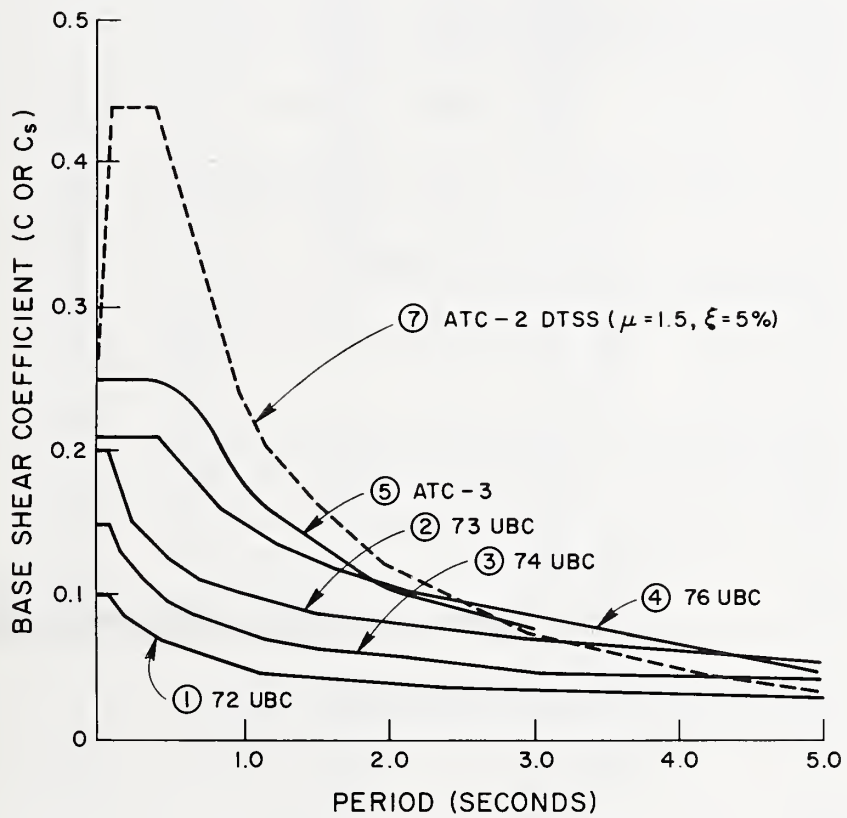

FIGURE 1 - EFFECTIVE SEISMIC DESIGN COEFFICIENTS

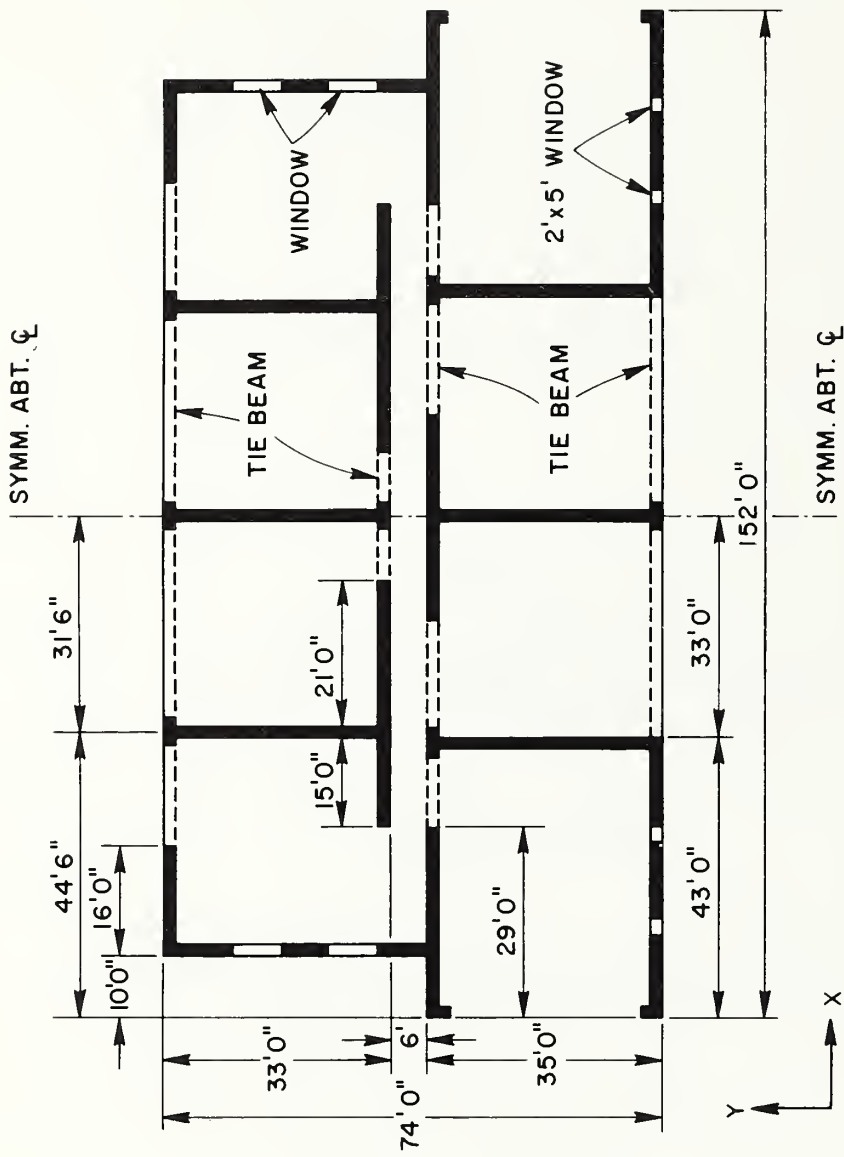

FIGURE 2 - FLOOR PLAN OF THE BUILDINGS

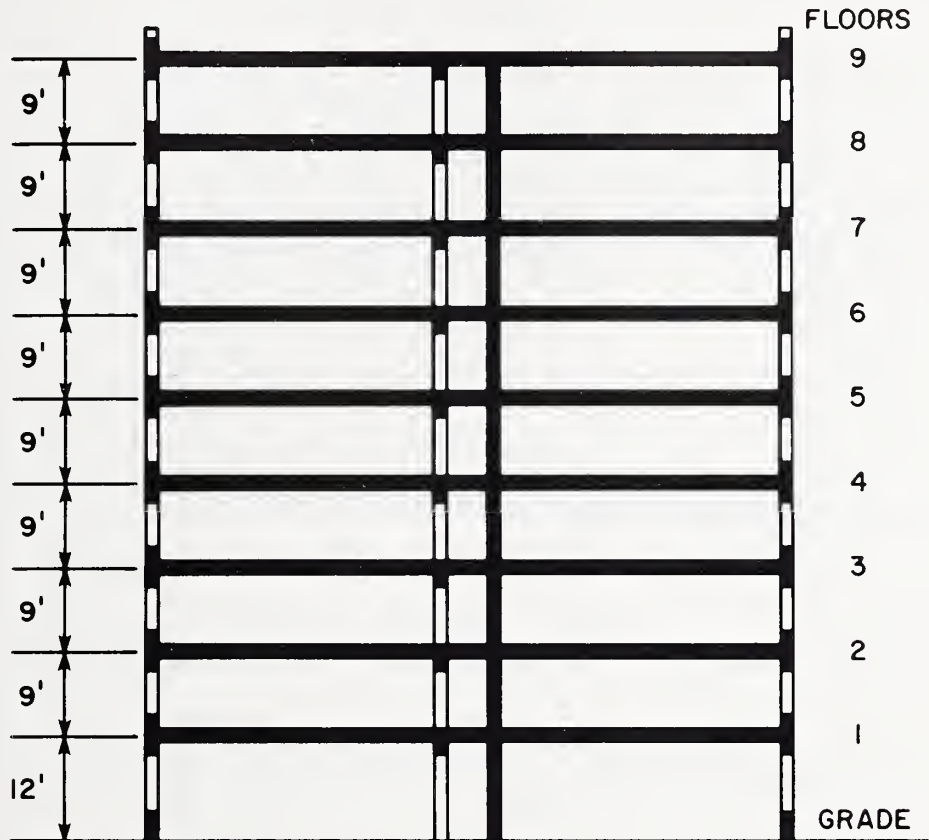

FIGURE 3 - BUILDING CROSS-SECTION AND WALL THICKNESSES

STUDY CASES	WALL THICKNESS		
	9 inches	11 inches	13 inches
"A" (3-story)	FL 1-FL 3	—	—
"B" (9-story)	FL 1-FL 5	FL6-FL 9	
"C" (17-story)	FL 1-FL 5	FL6-FL 11	FL11-FL 17

Note: For each case 1st FL. HT. = 12' 0"
 Remaining floors FL. HT. = 9' 0"

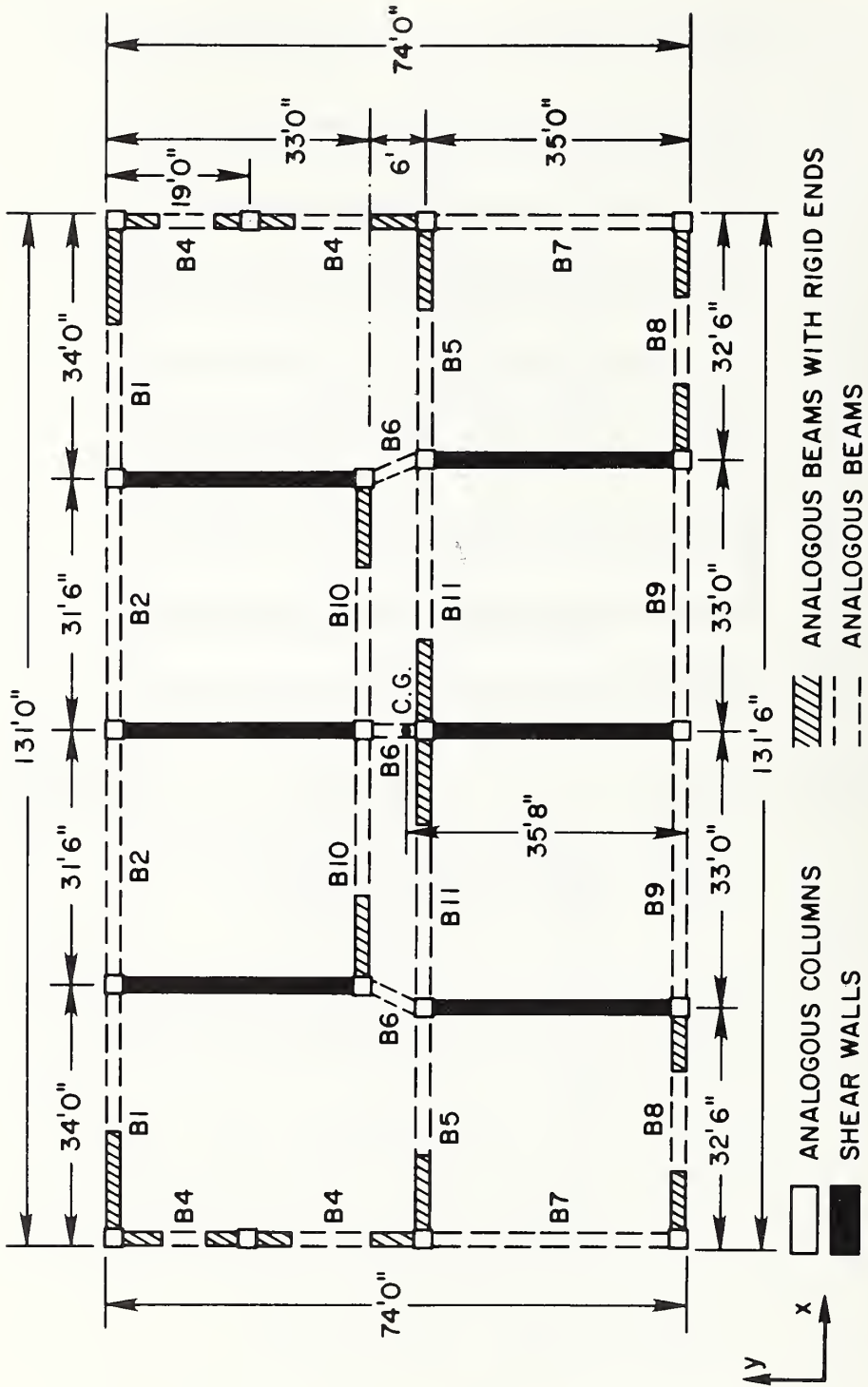

FIGURE 4 - ANALYTICAL MODEL OF MULTISTORY MASONRY APARTMENTS

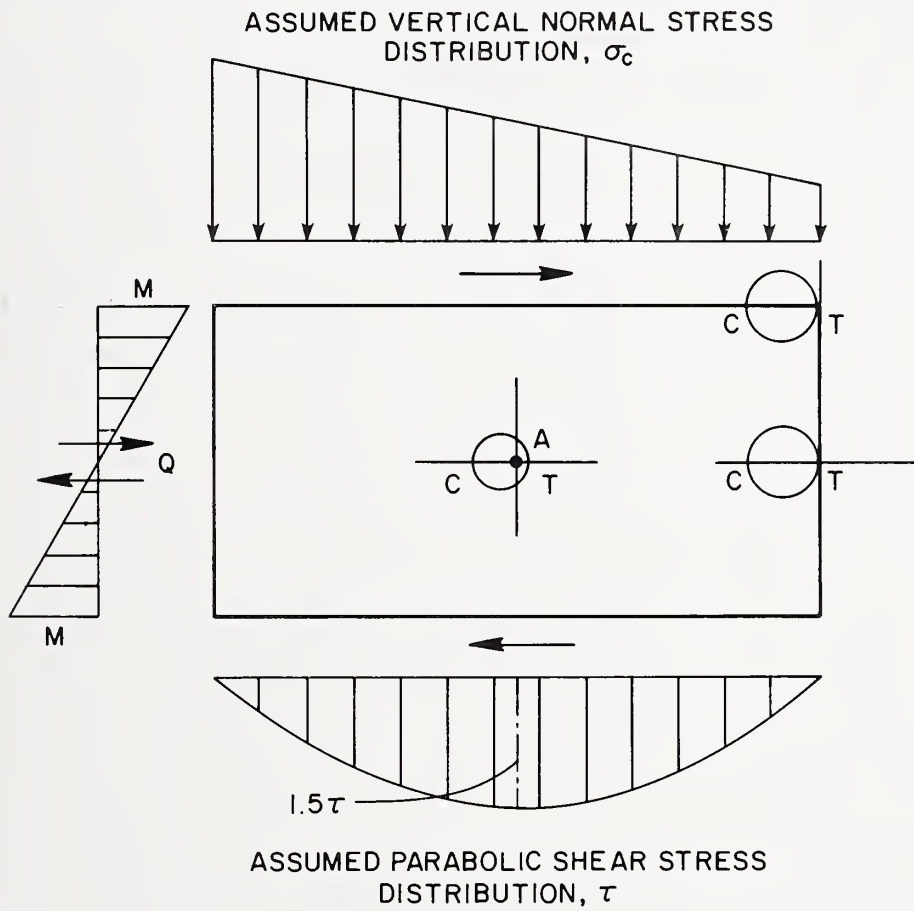

FIGURE 5 - ASSUMED STRESS DISTRIBUTION
OF THE PANELS

DISCUSSION

* * * *

Krishnamoorthy, San Diego State University:

Ron, [Mayes] in the work with the dynamic and static tests, regarding the differences in the results: can this be attributed to the quality of the construction? It varies from one specimen to another. Is it that significantly different to really tell that there is a great difference?

Mayes, University of California, Berkeley:

I think that (as far as I can see) there is definitely a difference that is not attributable to the workmanship. For the dynamic tests, it is an explosive removal of the masonry material, and that does not occur for the static tests - the material crushes but it stays there. For the dynamic test it just explodes out. We have it on a movie and it is very dramatic. You can tell; I'm sure you've seen it on your tests.

Maurenbrecher, National Research Council, Canada:

Have you investigated the effect of confining the reinforcement to stop this explosive failure?

Mayes:

Yes, we've looked at reinforcement in the joints. This was similar to that used by Priestley and Bridgeman and consisted of 1/8-inch thick plates embedded in the mortar joint. It substantially improved the behavior of the piers. Basically, it improves the ductility of the pier. It increases the effective ductility from on the order of 5 to about 10. That is a pretty significant increase and that is what Priestley and Bridgeman found as well. They induced another failure mechanism by doing that because they had the wall so strong. But, they had a sliding failure.

I must apologize for the lack of coordination in my program because we have done a study on codes and these results are very interesting. We have looked at all of them

from the '72 code right through to the proposed ATC-3 code and I hope I get an opportunity to go over these [1] because all this research is good but we have to evaluate it with respect to the codes; this is what we have tried to do. We have a report coming out on it and I am sure we will try to include most of you people on the distribution list so that you will be able to see it.

Webb, Department of Health, Education, and Welfare:

Mainly for my own purpose, I would like to tie down a definition, here, of the terms we are using with regard to working strength, ultimate strength, and limit design. I know I have difficulty in following some of the remarks because of the difference in meaning, perhaps in my own context. Would you care to do that for us please?

Mayes:

We use them, basically, for the purpose of interpreting the hysteresis envelopes that we got. We wanted to try to make some sense out of that and compare the various tests. We have a peak ultimate load which was the maximum load that was attained; we have what we called the average peak ultimate load which was about 95% of that peak and which was maintained over 3 or 4 cycles of loading; and then, we have a working ultimate strength (or working peak ultimate strength, whatever you like) which was when first cracking occurred in the piers, (this was not substantial cracking; it was just minor cracking) and that was on the order of 70 to 80% of the peak ultimate load. We did this just for the purpose of comparing the various results. Of course, when we do look at code provisions you can take whichever one of those you like, depending on how conservative you wish to be.

Fintel, Portland Cement Association:

How did you define ductility?

Mayes:

We did not define ductility, as such; we defined ductility indicators. We defined these as displacement ratios over which a given load was maintained. So it was not an

elastoplastic type of ductility that many of you may be familiar with. It was defined, basically, as the displacement at which the load was first attained, divided into the displacement at which that load could no longer be maintained. The load, in fact, went larger than that particular load. For instance [using chalkboard] [also see Figure 6] as I said, the working ultimate load, was 70% of the peak. If you can imagine a hysteresis curve like that and you extend the peak ultimate load across, it was the ratio of those two displacements that intersect the hysteresis envelope. It was done that way, as I said for the purpose of making some sense of the results.

Agbabian, (Agbabian Associates):

I would like to know what your plans are for the following years, if you can tell them in a few minutes. I have heard that you were planning to run some shake table experiments. Is that correct? What do you propose to do?

Mayes:

In the National Science Foundation program which is for the cantilever tests that we are doing, we have planned 80 test panels (not on the shake table). In the HUD funded program, concerning masonry housing construction, the ultimate goal is to put part of a house on the shaking table and test that to see what it can withstand. We were going to put a full, half-scale model of a house on; we have since changed our plans and will be putting on part of a house (two end walls; two side panels; and a roof structure of some sort). We will probably do two or three different types of those.

Sanidas, City of Memphis:

I know you didn't get a chance to get into your discussion of the ICBO Code [1], but, did it come out positive or negative?

Mayes:

Negative.

Sanidas:

There is a question that I would like to ask Dr. Scalzi: I notice that two of the code representatives are not here for their talks tomorrow afternoon; would it be at all possible to hear Professor Mayes' presentation [1] tomorrow afternoon in lieu of Tangye and Bush who are not here? I think that some of us are very interested in how this comparison came out.

Scalzi, Session Chairman:

We'll see how the schedule goes.

Sanidas:

Thank you.

Scalzi:

I guess we would have to limit the subsequent speakers to comparable time (and hopefully, less) in making their presentations. Possibly we can ask them to summarize a little bit more, as they go along, rather than getting into all the extreme details of the research program. I would like to emphasize that we are interested in the thoughts and concepts here and if they pertain to our workshop discussion - fine; but if we are going to get into some of the details of the testing program that may be strictly research, perhaps those can wait.

* * * *

[1] This presentation was made at a later time and has been inserted on pp. 91 (et seq.) for convenience.

AN EXPERIMENTAL STUDY OF CONCRETE MASONRY
UNDER SEISMIC - TYPE LOADING

G. A. Hegemier¹, G. Krishnamoorthy², R. O. Nunn³

ABSTRACT

This paper outlines portions of a comprehensive research program on concrete masonry. Objectives, scope, methodology, and sample results obtained to date are presented. Where appropriate, practical implications of the latter are delineated. Future experiments are discussed.

I. INTRODUCTION

1.1 The Program

The development of a basis for a rational earthquake response and damage analysis of concrete masonry structures is the subject of an extensive experimental, analytical, and numerical research program at the San Diego campus of the University of California. The program is sponsored by the National Science Foundation under project RANN.

The experimental effort is intended to define material rheology. The analytical phase involves the translation of observed experimental data into viable mathematical models. The numerical effort concerns the conversion of mathematical models into numerical form and the construction of digital computer codes to simulate structural response and damage accumulation resulting from earthquake ground motion.

Discussion in this paper is confined to the experimental portion of the program.

¹Professor, Dept Appl Mechs & Engr Sci, University of California, San Diego, La Jolla, California, 92093.

²Professor, Dept Civil Engr, San Diego State University, San Diego, California, 92182.

³Graduate Student, Dept Appl Mechs & Engr Sci, University of California, San Diego, La Jolla, California, 92093.

1.2 The Approach

The approach selected to achieve the project objectives involves a sequence of increasingly complex levels of concurrent experimentation, analysis, and numerical simulation. This sequence begins with elementary experiments on the basic constituents of concrete masonry and their interactions, e g, by fracture and slip across interfaces. It proceeds to homogeneous and nonhomogeneous biaxial tests of panels under both quasi-static and dynamic cyclic load histories. The above is complemented by tests on typical connections (to be discussed in a companion paper). The sequence culminates with studies of major structural elements. The ability to extrapolate from conceptually simple laboratory scale experiments to a wide variety of structural configurations, including full-scale building response to earthquake ground motion, is one of the most significant aspects of the project.

1.3 The Need for Research

Comprehensive surveys of the available literature relevant to the mechanics of concrete masonry assemblies can be found in references [1,2]. Examination of these reports reveals that, although a measurable amount of research on concrete masonry has been conducted over the past forty to fifty years, there currently exists little correlation among the various studies conducted by governmental, university, and promotional research organizations. Each study has, of economic necessity and/or impatience, been constrained within narrow bounds and primarily to specific structural configurations rather than to fundamental material research. As a result, a virtual vacuum exists concerning the material properties of concrete masonry, and the behavior of typical connections used in concrete masonry systems. In the absence of reliable data, subjective judgement must be substituted for a rational analysis. The ramifications of this substitution are obvious and clearly undesirable. The present program constitutes a major step in the direction of alleviating the above problem.

II. MATERIAL TEST PROGRAM - DESCRIPTION

2.1 Basic Items Under Study

The basic experimental items under current study concern planar material behavior and are related to the construction of constitutive relations for concrete masonry in both linear and nonlinear ranges. Included are:

- . Strength and damage accumulation under combined plane-stress states
- . Stiffness parameters
- . Energy absorption and damping

In each of the above areas, studies are well underway to determine the:

- . Degree of anisotropy
- . Degree of strain-rate sensitivity
- . Influence of reinforcing steel
- . Influence of compaction (vibration)
- . Influence of admixtures
- . Influence of flaws
- . Influence of constituent properties on assembly properties
- . Scale effects
- . Degradation under cyclic load histories

2.2 Methodology

The program partitions naturally into two main categories: (1) Small-scale or "microelement" tests and (2) Large-scale or "macroelement" tests.

The objective of the small-scale tests is to synthesize the behavior or properties of masonry assemblies or macroelements from simple but universal experiments - experiments that can be conducted in a standard laboratory. At the very least such tests provide an index concerning the influence of the basic constituents on assembly behavior.

The large-scale or macroelement tests constitute a necessary check on the micro-modeling process and, perhaps more important, constitute the starting point for the

construction of a continuum model of concrete masonry. The latter, it is anticipated, may be used to efficiently synthesize the behavior of complex structures, in combination with appropriate connection data, through the use of explicit analytical and numerical techniques.

The overall methodology is depicted in Fig 1.

2.3 Materials

Two nominal⁴ masonry types are currently under study: (1) "normal strength" - type N normal weight concrete block (ASTM C90), type S mortar (ASTM C270), 2000 psi coarse (pump mix, 8-10 inch slump) grout (ASTM C476); (2) "high strength" - light-weight block ($f'_c \geq 3750$ psi, type M mortar (ASTM C270), 3750 psi coarse (pump mix, 8-10 inch slump) grout (ASTM C476).

Most specimens consist of running bond with face-shell bedding. Both closed and open-end units are utilized, although focus is currently on the former. Standard 8-inch high, 8-inch wide block geometries [1] are employed.

2.4 Small-Scale Tests

Testing and modeling on the micro-scale commences at the constituent level and requires a knowledge of constituent, constituent-interface and small assembly behavior under various stress states.

Constituent tests serve as index factors for each test series (micro or macro). Test data includes elastic moduli, compressive strength, and tensile strength of block, grout, and mortar. Information on unit-absorption, and design mixes for each component is also obtained.

Joint tests are of considerable interest. Joints or interfaces in concrete masonry assemblies constitute both planes of weakness and a major source of damping. Failures

⁴Precise details concerning material properties are provided in appropriate sections to follow.

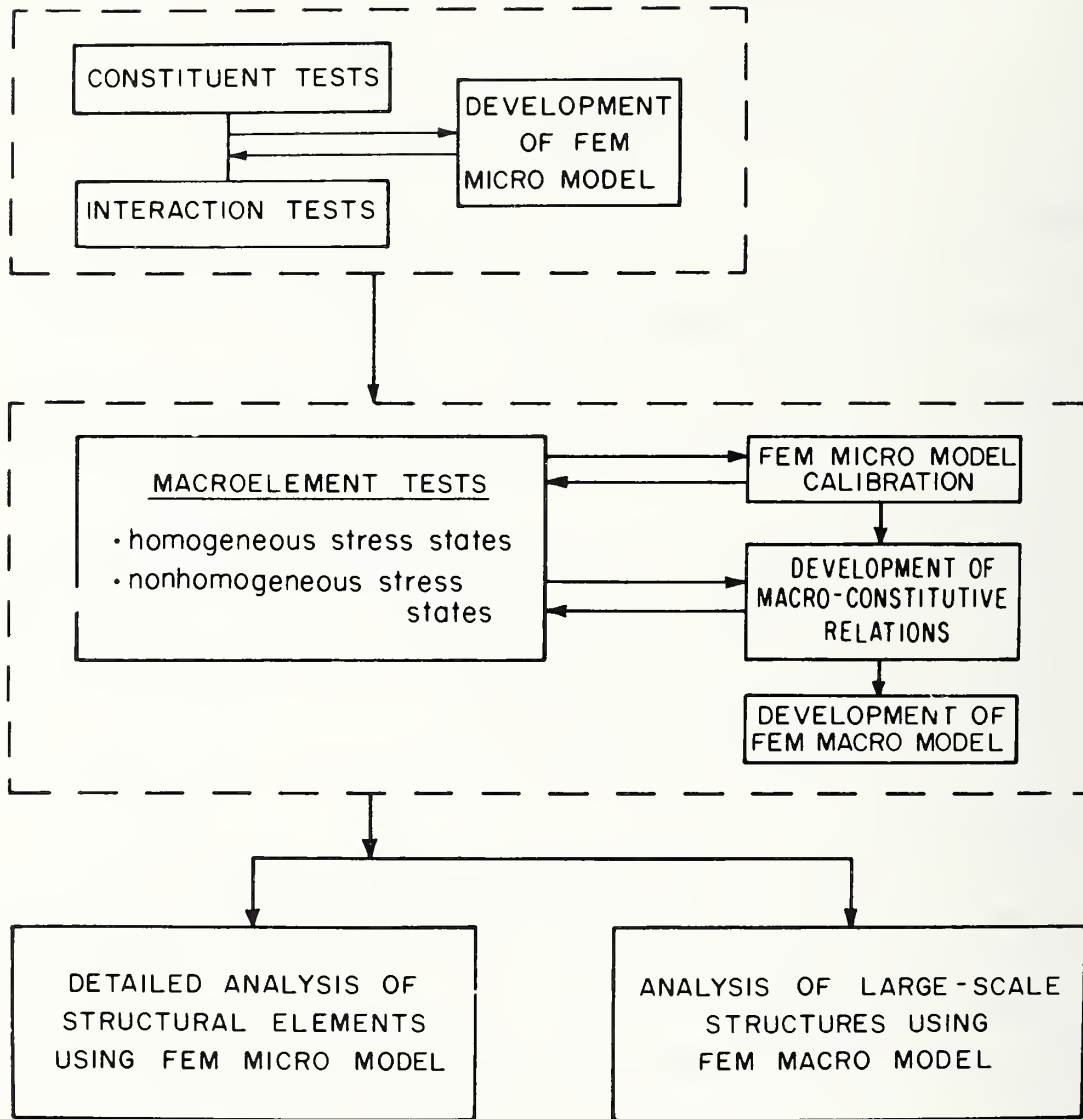

Fig. 1 Methodology of Research Program.

frequently initiate in joints, and subsequent deformation and energy absorption may occur by relative slip across joint planes. Joint types selected for study include: (1) ungrouted bed joints; (2) grouted bed joints with and without steel; (3) head joints; (4) combination head and bed joints; (5) and block-grout interfaces. Mortar geometry includes both full and face-shell bedding. Test specimens in the joint-series consist primarily of triplets (three blocks, two interfaces). Six inch cores are utilized for block-grout interface tests. Joint planes are subjected to constant levels of normal stress and quasi-static monotonic, quasi-static cyclic, or dynamic cyclic shear stress. In each test the initial and post-fracture shear-stress vs normal stress envelopes, and deformation histories, are determined.

In addition to the above, a variety of prism (small assembly) tests are well underway. These tests are designed to provide basic information on: (1) the influence of the number of courses on compressive strength and associated problems regarding load-platen restraint; (2) the influence of flaws, compaction, and admixtures on compressive and tensile strength; (3) the correlation of compressive and tensile strengths; (4) correlation of block, grout, and mortar strengths to prism strengths; (5) stiffness parameters and uniaxial stress-strain behavior (these include Young's modulus in tension, Young's modulus in compression, ratio of tensile to compressive strengths, ratio of tensile strength to tensile modulus, ratio of compressive strength to compressive modulus).

2.5 Static and Dynamic Biaxial Panel Tests

As was noted previously, modeling on the continuum or macro-scale, and calibration of micro-models, is accomplished via biaxial panel tests of two basic stress state types: homogeneous and nonhomogeneous. The specimens in this test series are approximately one order of magnitude larger than the typical microdimension.

2.5.1 Globally Homogeneous Stress-States

These tests are unique in that the panels are laid in running bond, but are saw-cut such that the bonds run at oblique incidence or layup to the edges of the finished panel. The rationale: any combination of homogeneous shear and normal stresses on the critical bed and head joint planes can be induced by application of direct (principal) stresses (compression or tension) to panel edges, and the selection of a proper layup angle. The ability to apply direct tensile stresses which exceed the tensile strength of the assembly, and direct compressive stresses with negligible induced shear, follows from the use of a unique polysulfide bonding agent with a low shear modulus (≈ 150 psi) between the specimen and the load distribution fixtures. In the case of uniform load application to each panel edge, the resulting panel stress distribution is globally homogeneous, and hence statically determinate. Thus, in contrast to conventional test methods [2], the determination of material properties is not prejudiced by boundary constraints; further, in contrast to indirect methods [1], extraction of biaxial failure states does not necessitate a conjecture of isotropic, linear elastic material behavior prior to macrocracking.

Figure 2 illustrates the basic concept of oblique layup testing. If the x_1, x_2 - axes are principal stress directions, then the stress resultants⁵ N_{11}' , N_{22}' , N_{12}' associated with axes x_1', x_2' along the bed and head joint directions are related to the principal stress resultants N_{11}, N_{22} through

$$N_{11}', N_{22}' = \frac{N_{11} + N_{22}}{2} \pm \frac{N_{11} - N_{22}}{2} \cos 2\theta, N_{12}' = \frac{N_{22} - N_{11}}{2} \sin 2\theta \quad (1)$$

Equations (1) imply that any homogeneous stress-state ($N_{11}', N_{22}', N_{12}'$) in a panel with surfaces oriented parallel to the head and bed joints can be obtained by selecting an appropriate layup angle θ and direct stress resultants N_{11}, N_{22} . In particular, given a desired stress-state ($N_{11}', N_{22}', N_{12}'$), the combination (N_{11}, N_{22}, θ) is selected according to

⁵Stress resultants are related to stress by $\sigma_{ij} = N_{ij}/t$, where t is the panel thickness.

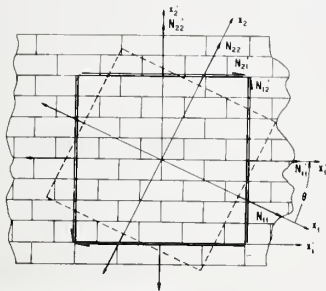

Fig. 2 Stress Transformation.

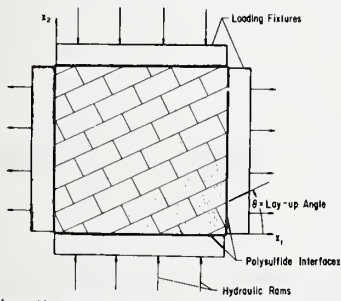

Fig. 3 Loading Schematic.

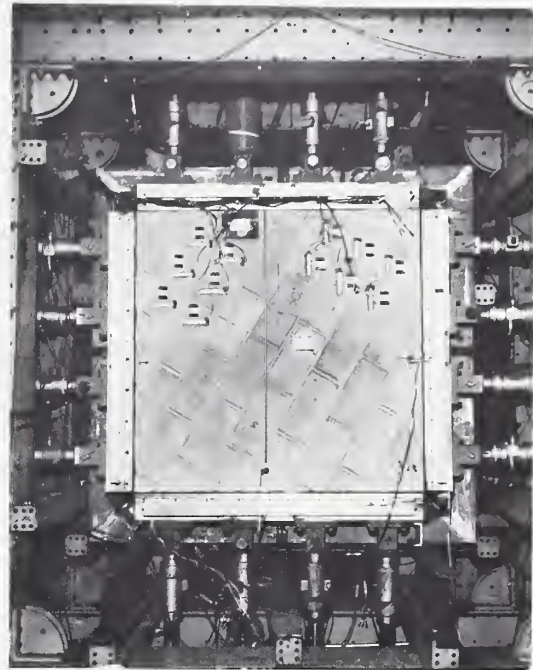

Fig. 4 Biaxial Fixture.

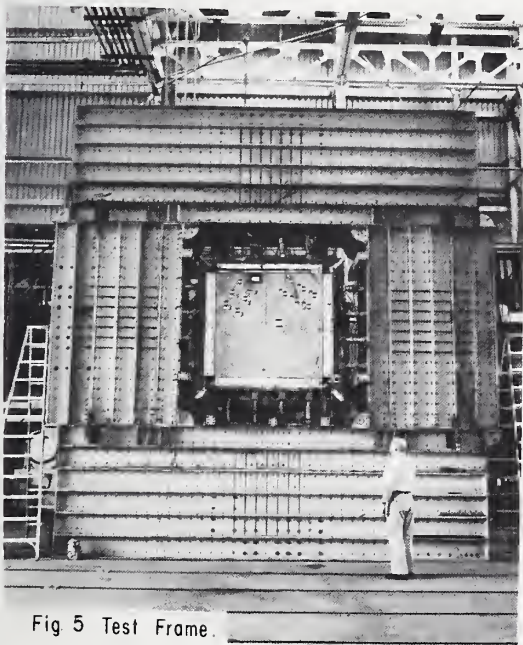

Fig. 5 Test Frame.

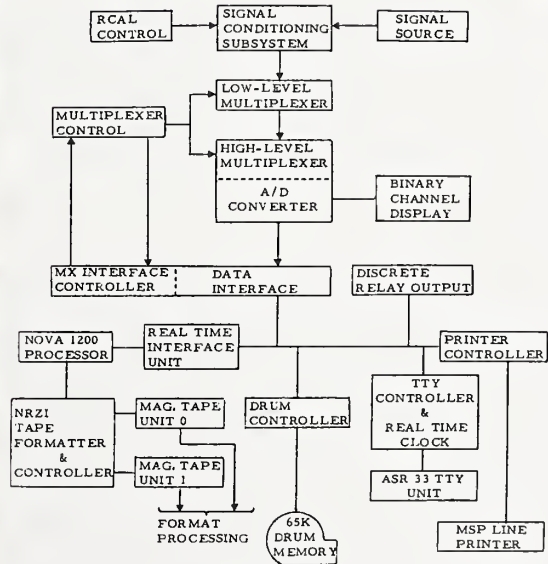

Fig. 6 Data Acquisition.

$$N_{11}', N_{22}' = \frac{N_{11}' + N_{22}'}{2} \pm \frac{N_{11}' - N_{22}'}{2} \cos 2\theta \mp N_{12}' \sin 2\theta$$

$$\tan 2\theta = -2N_{12}' / (N_{11}' - N_{22}')$$
(2)

The test panels of 64-by-64 inches are precision cut from 8-by-8 foot fully grouted, unreinforced or reinforced concrete masonry walls constructed to current field practice. Cutting is accomplished by use of a dynamically balanced, 30-inch-diameter, diamond-edge saw on an air-driven turbine. The above panel size constitutes the smallest specimen deemed to be a macroelement, i.e., such that the minimum panel (planar) dimension is one order of magnitude greater than the largest microelements (block units).

A schematic of the biaxial test procedure is shown in Fig 3. The actual setup is illustrated in Fig 4. The load conditions include quasi-static monotonic, quasi-static cyclic, and dynamic cyclic (.05 to 5Hz). The system is capable of load, displacement, or combined load-displacement control. This is accomplished with a mini-computer-controlled, closed-loop-hydraulic-servo system utilizing four active actuators on each panel side connected to load distribution fixtures. This test system is housed in a massive dual test frame, Fig 5. A high-speed digital data acquisition system (14 bits absolute value plus sign, 300 samples/sec/channel or 15,000 samples/sec total), Fig 6, monitors 40 channels of signals from load cells, linear variable differential transformers (LVDT's), and strain gages.

Rheological aspects of singular interest include: (1) elastic properties; (2) degree of anisotropy of elastic properties; (3) damping or stress-strain hysteresis in the "elastic" regime; (4) strain-rate sensitivity of item 3, above, in the .05 to 4Hz range; (5) initial "yield" or macro-fracture surface in stress-space; (6) degree of anisotropy of item 5 above; (7) ultimate strength; (8) influence of load history on the degradation of stiffness and ultimate strength; (9) hysteresis in the highly nonlinear range; (10) role of reinforcing steel geometry and volume in the control of macrocracking; and (11) flaw sensitivity.

2.5.2 Nonhomogeneous Stress-States

The significance of these tests is as follows. Homogeneous stress-state tests, as described in the previous section, assume that characteristic lengths associated with variation in the stress field are large when compared with the typical microdimensions of the material. In plain concrete this rarely presents a problem⁶ since the typical microdimension is associated with the largest aggregate dimension, which in turn is small. In concrete masonry, on the other hand, the typical microdimension is quite large-8 to 16 inches (the block size). Thus, the typical microdimension of this material may not be small where compared with either the structural-element size or the characteristic length of the stress field. In such a case it is necessary to create a material model which, to a certain degree of accuracy, reflects the influence of the microstructure. Nonhomogeneous stress-state tests are a necessary step in this process. They comprise an advanced step in the micromodeling process, and a first evaluation of the limits of application of the macro or continuum modeling process, and modification of the latter to reflect microstructural effects.

The tests in this series consist of two types: (1) simple shear deformation and (2) diagonal compression. A brief discussion of each is presented below.

2.5.2.1 Simple Shear Deformation

The test system described above, as modified according to Fig 7, and with a modified bonding agent, is capable of creating simple shear deformation (in contrast to pure shear stress) - with superposed axial deformation or stress. Such tests, to be conducted on 0 degree layup specimens only, mirror the behavior of shear walls and piers under varying degrees of end constraint. Consequently, this test-type serves to calibrate all modeling in a region of primary interest. The rheological items of interest here are similar to those listed under Section 2.5.1.

⁶ It does present a problem in reinforced concrete.

2.5.2.2 Diagonal Compression

This test, which is illustrated in Fig 8, is actually an indirect biaxial test [1]. Under concentrated diagonal compressive loads, the central portion of the specimen is subjected to a biaxial stress-state which is reasonably uniform over a characteristic length (area). This length, however, is not large when compared to the material micro-dimensions; hence the test constitutes a simple check on the limits of application of the homogeneous failure data obtained from the tests of Section 2.5.1.

The above test, by the way, is greatly misunderstood in the literature. Most documents interpret the test results incorrectly (e g, see ASTM E519-74). It is not a shear test; the shear stress on the planes intersecting diagonals vanishes from symmetry. Failure occurs by induced tensile stresses on the vertical plane of symmetry (see Fig 9).

III. MATERIAL TEST PROGRAM - SUMMARY

For the convenience of the reader, the material test program discussed in the previous section is summarized below.

3.1 Constituent Tests

- . Compressive and tensile strength of grout, mortar, block
- . Shear and tensile strength of bonds or interfaces
- . Elastic moduli of block, grout, mortar
- . Absorption of units

3.2 Prism Tests

- . Influence of number of courses on compressive strength
- . Influence of flaws on compressive and tensile strengths
- . Influence of compaction and admixtures on compressive and tensile strengths
- . Correlation of compressive and tensile strengths
- . Correlation of block, grout, and mortar strengths to prism strengths

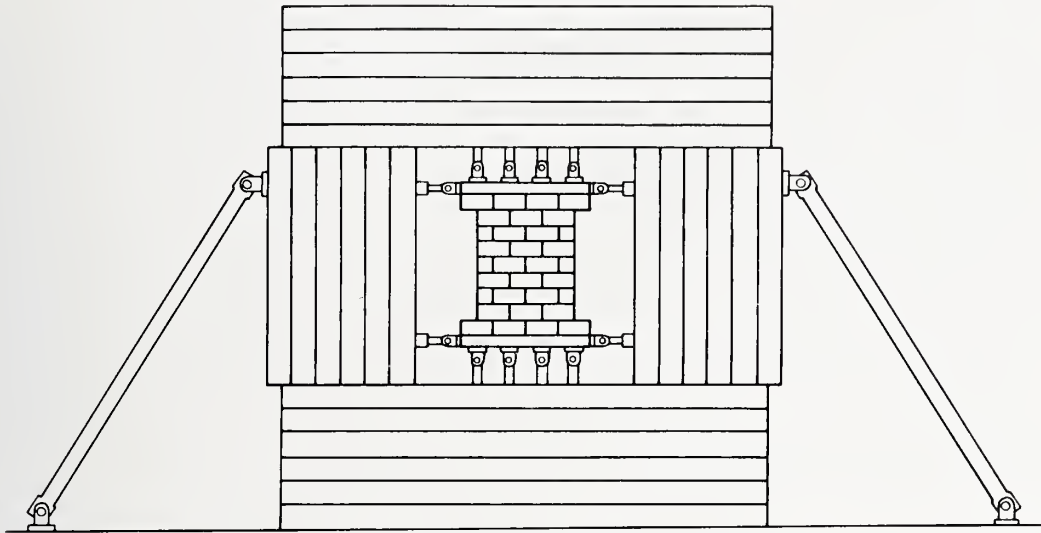

Fig. 7 Panel Shear Test.

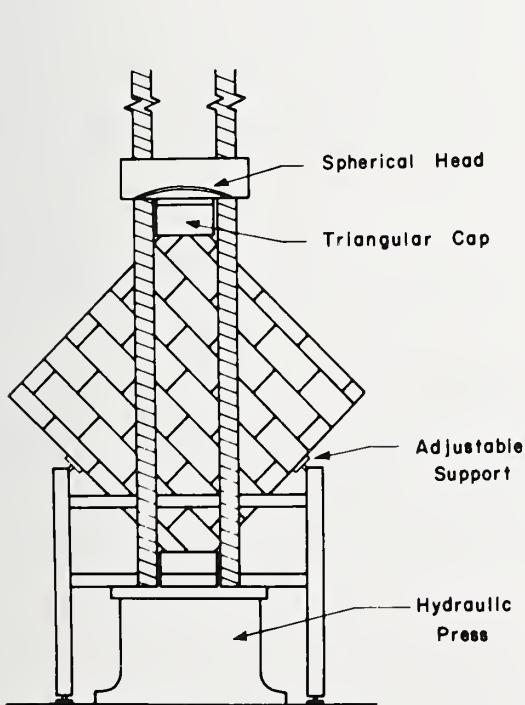

Fig. 8 Diagonal Compression Test.

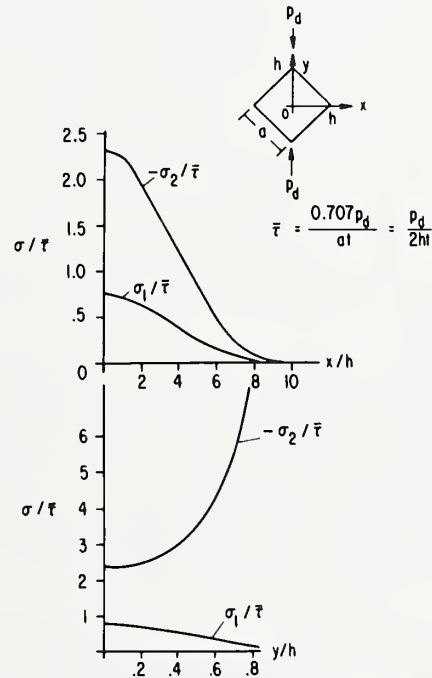

Fig. 9 Diagonal Compression Test: Principal Stress Distribution on the Planes $y = 0$ and $x = 0$.

- . Stiffness parameters and uniaxial stress-strain behavior (Young's modulus in tension and compression, ratio of tensile strength to compressive strength, ratio of tensile strength to tensile modulus, ratio of compressive strength to compressive modulus)

3.3 Interface Tests

- . Strength of ungrouted bed joints
- . Strength of grouted bed joints
- . Strength of head joints
- . Post fracture slip-behavior of joints
- . Influence of steel on joint properties
- . Block-grout interface strength

3.4 Full Scale Tests (Homogeneous stress states)

- . Biaxial failure envelopes (Degree of anisotropy, influence of flaws, influence of compaction, influence of admixtures, influence of steel)
- . Post macrocracking hysteretic behavior (reinforced specimens only)
- . Elastic moduli (Young's modulus, Poisson's ratio, degree of anisotropy)
- . Damping and energy absorption
- . Prediction of failure and elastic properties from small-scale tests; scale effects

3.5 Full Scale Tests (Nonhomogeneous stress states)

- . Simple shear deformation - monotonic and cyclic loading (stiffness degradation, energy absorption, ultimate failure, general hysteretic behavior)
- . Diagonal compression test (significance, correlation with biaxial failure data)

IV. SELECTED RESULTS - PANELS

The purpose of this section is to present sample results obtained to date under this program. The discussion is intended for illustrative purposes only, and is confined to basic features of experimental data. Design recommendations are not made herein; the

latter must await completion of appropriate test series, comprehensive data reduction, data interpretation and case studies.

A complete description of the biaxial tests is beyond the scope of this presentation. For simplicity, attention is focused below upon the homogeneous stress-state tests and the associated following items: (1) the failure surface for fully grouted but unreinforced specimens; (2) failure data and anisotropy; (3) elastic properties and anisotropy; (4) damping and strain-rate effects in the linear range; (5) the estimation of macroelement properties from component properties; (6) the influence of flaws, compaction, and admixtures on failure; and (7) the influence of reinforcing steel on the control of cracking and damage.

4.1 Materials

Typical component properties associated with the macroelements to be discussed are provided in Table 1 (for grout properties refer to column marked STD). Specimens were cut from fully grouted, 8x8-foot-walls. Grouting was accomplished in 8-foot lifts (pump). Compaction by puddling or vibration was conducted as indicated.

4.2 Failure Surface

Complete mapping of the failure surface of a macroelement in the stress space $(N_{11}', N_{22}', N_{12}')$, or the principal stress vs θ - space (N_{11}, N_{22}, θ) is a major undertaking. This problem is, however, alleviated by two factors; (1) extensive calculations concerning shear walls and other complex structures reveal that, in most applications, the normal stress on head joint planes is small when compared with normal and shear stress on bed joint planes, i e,

$$N_{11}' \ll N_{22}', N_{12}' ; \quad (3)$$

and (2) experimental data shows a weak dependence of failure on the layup angle θ , i e, the composite under consideration is approximately isotropic (this point will be discussed later).

Table 1. Component Properties for Macroelements and Prisms.

	Block [†]	Mortar	Grout [‡]	
			STD	ADM
Compressive Strength (ksi)	3.97	2.42	4.03	4.34
	2.97	2.86	3.53	3.79
	3.27	2.39	3.51	3.41
	2.95	2.66	3.79	3.72
	3.41	2.83	4.15	3.66
	3.16	2.03	3.69	
	3.00	1.77	3.69	
	3.68		4.32	
			4.35	
			3.98	
		4.17		
		3.25		
mean	3.30	2.42	3.87	3.78
std. dev.	.37	.41	.35	.34
Tensile Strength (ksi)	310	229	247	
	291	253	253	
	373	162	324	
	294			
	297		240	
	363			
	377			
	mean	329	215	266
std. dev.	40	47	39	
Young's Modulus, Compression (psi)	2.5 × 10 ⁶ (2.2-2.8)		2.6 × 10 ⁶ (2.5-2.7)	
Young's Modulus, Tension (psi)			2.3 × 10 ⁶ (2.1-2.5)	
Poisson's Ratio	.16 (.14-.18)		.16	

[†]Block: Type N, ASTM C90 Block; test coupons approx. 4.0" x 6.5" cut from face shells.

[‡]Grout: Coarse grout, ASTM C476 (6-sack grout)

A typical intersection of the material (macroelement) failure surface with the plane $N_{11}' = 0$ (see Section 2.5.1) is illustrated in Fig 10 for fully grouted but unreinforced specimens. The rays in these figures represent the layup angles and the corresponding proportional loading which results from the condition $N_{11}' = 0$ in equation (2), while equation (1) furnishes

$$N_{11} = - N_{22} \tan^2 \theta . \quad (4)$$

Data points, which represent statistical means of repeated tests, are denoted by circles and triangles. Stresses shown are based upon net cross-sectional areas.

Two basic failure modes were observed in these tests. In the tension zone, and in the compression zone for $|\theta| > 15$ deg, a brittle failure with a single crack was frequently observed, as illustrated in Fig 11a. ($\theta = - 45$ deg). In the compression zone for $|\theta| < 15$ deg, failure appears to consist of multiple cracks, as shown in Fig 11b for $\theta = - 10$ deg.

The curves in Fig 10 represent several macroscopic, analytical failure models considered to date. The dotted curve, shown for batch 6, is based upon the premise that failure occurs when a principal stress reaches either the tensile strength or the compressive strength associated with a uniaxial, 0 deg layup test. The solid curves result from the premise that the failure envelope in principal stress-space is linear in the tension-compression zone, as illustrated in Fig 12 for plain concrete under biaxial stress states. This model is seen to provide a more accurate description of material behavior. The two solid curves in Fig 10 correspond to estimated (from prism tests) compressive strengths, and measured (from 0 deg layup panels) uniaxial tensile strengths for two groups of specimens. Note that only two experiments are necessary for construction of this failure model: (1) the uniaxial tensile strength and (2) the uniaxial compressive strength. The dashed curve represents a modification of the solid curve for batch 6, to account for the anisotropy discussed below.

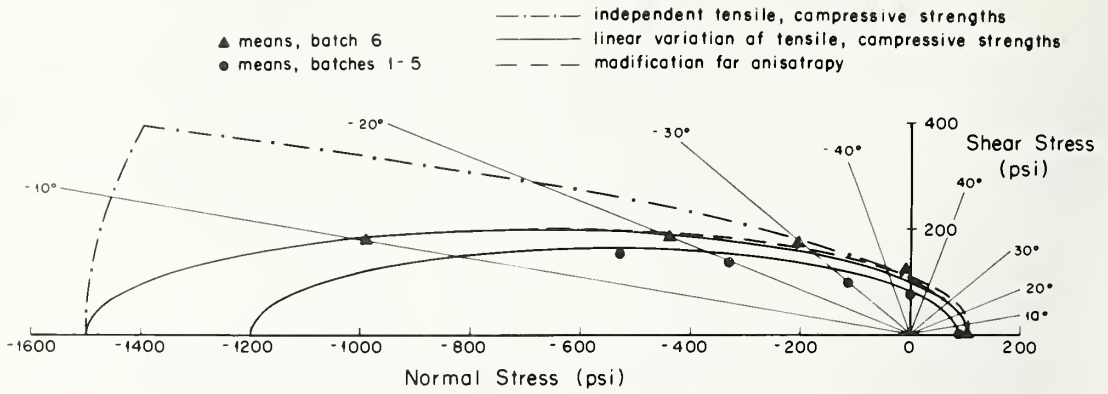

Fig. 10 Failure Envelope for Zero Head Joint Normal Stress.

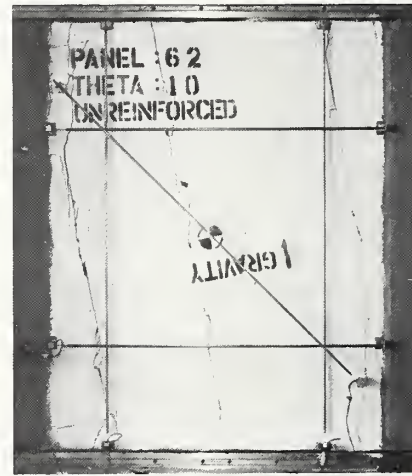
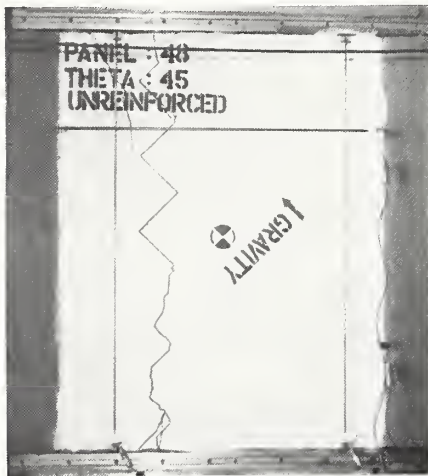

Fig. 11(a) Typical Joint Failure. Fig. 11(b) Multi-Crack Failure.

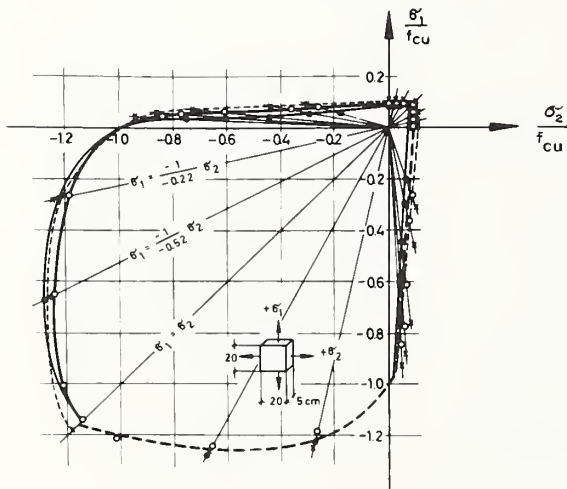

Fig. 12 Biaxial Strength of Concrete.

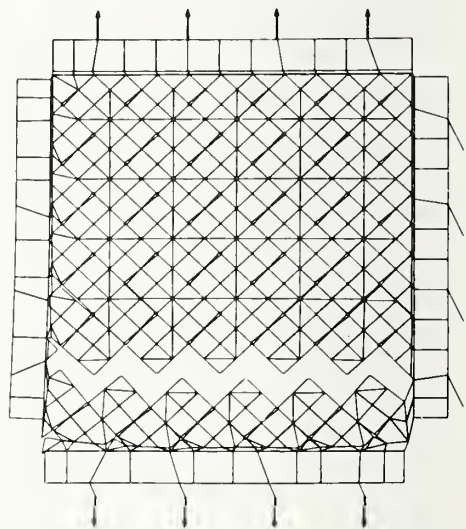

Fig. 13 Finite Element Prediction of Failure.

4.3 Failure and Isotropy

The above premise regarding the linear decrease of tensile strength in the presence of (principal) compressive stress is substantiated by Fig 14. Data on macroelement tensile failure indicates a slight increase in strength for layup angles near 45 deg, as shown in Fig 15, but the premise of material isotropy can be seen to hold within normal data-scatter for brittle materials of the type under consideration. For a layup angle of 0 deg, tension is applied to the bed joints. Each curve in Fig 15 represents a fit to the data of a second degree polynomial.

It should be noted that material anisotropy for a macroelement is a direct function of block and grout strengths. The strength combinations under study, by accident, led to an essentially isotropic material. The latter can be destroyed by a non-judicious selection of block and grout strengths. Estimation of material anisotropy from component properties is discussed in a later section.

4.4 Failure and Micro-modeling

It was noted above that a relatively elementary analytical model will suffice to predict failure. In more complex situations involving nonhomogeneous stress fields with large stress gradients and complex deformation fields, a more detailed analysis may be necessary. It is for this purpose that the micro-modeling is being pursued. Finite element simulations of panel behavior have been performed to assess the accuracy of current micro-modeling concepts. For this purpose the panel assembly is discretized into a system of plane stress finite elements. The grouted block and the adjacent mortar are represented by a single material whose properties are determined by a volume-based mixture procedure. The masonry joints are represented by an interface utilizing the interface technique discussed in reference [3]. Interface properties are determined from joint tests discussed in a subsequent section. A typical fracture pattern for a 45 deg uniaxial case is shown in Fig 13; this discretized system has 1674 degrees of freedom and a bandwidth of 154. The results of analysis performed to date, which were obtained by

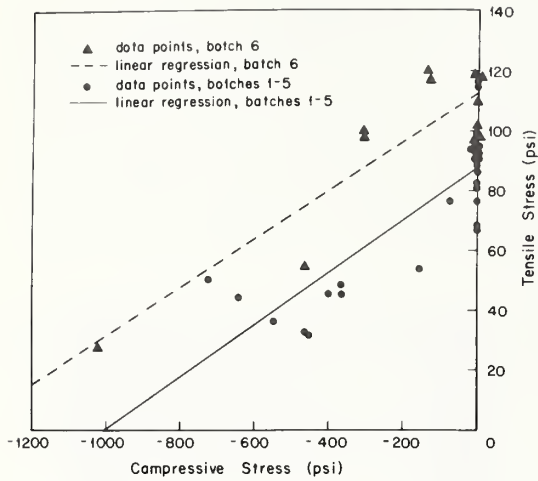

Fig. 14 Dependence of Panel Tensile Strength on Compressive Stress.

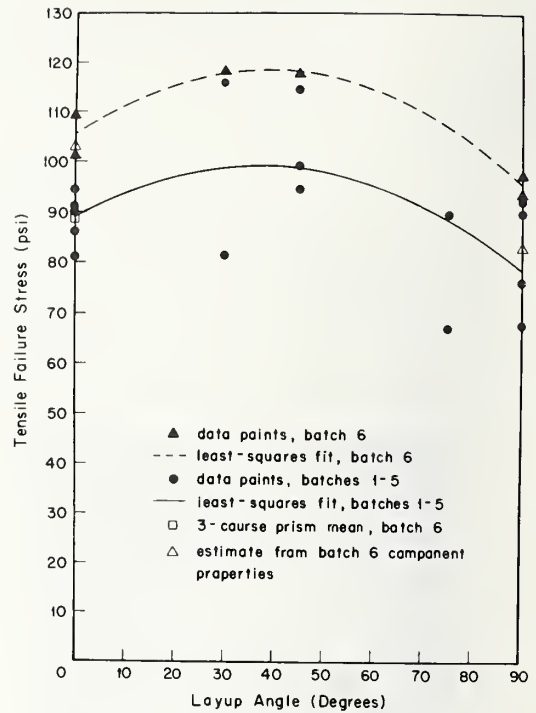

Fig. 15 Panel Tensile Strength Anisotropy.

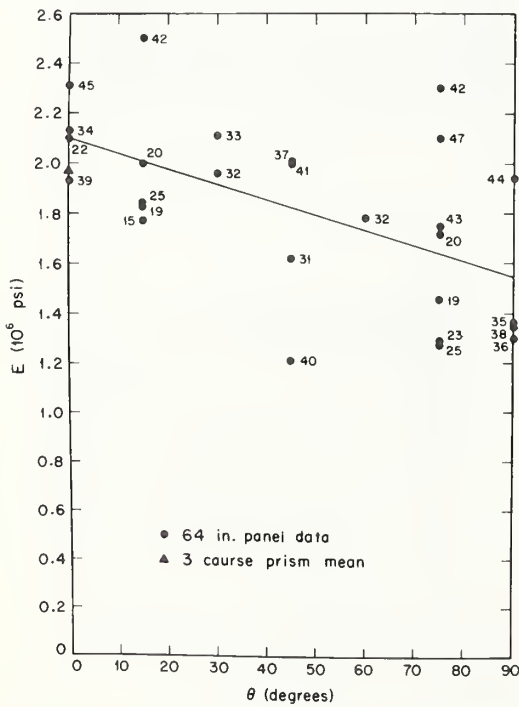

Fig. 16 Panel Stiffness Anisotropy.

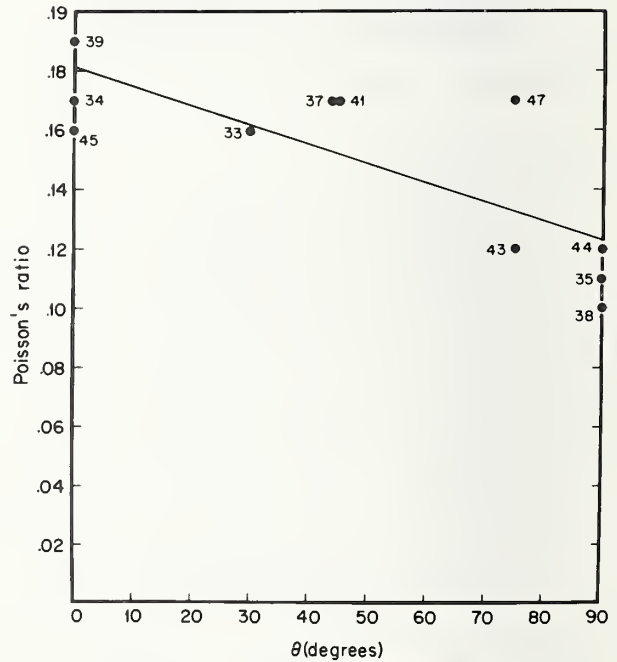

Fig. 17 Panel Poisson's Ratio Anisotropy.

using an out-of-core version of NONSAP, show excellent correlation with experimental data; for example, the ultimate strength of the model shown in Fig 12 was approximately 77 psi, compared to 80 psi obtained experimentally.

4.5 Elastic Moduli and Anisotropy

Typical variations of Young's modulus and Poisson's ratio with θ for the materials discussed above are illustrated in Figs 16, 17. This data was obtained via compression in the range 0-300 psi. A linear regression analysis of the data shows a clear trend wherein both moduli decrease from $\theta = 0$ deg (compression across bed joint planes) to $\theta = 90$ deg (compression across head joint planes). Since most specimens provide two data points (by reversing the roles of the principal stresses), one may observe this trend in the absence of data scatter by following the same specimen number in Fig 16. Compare, for example, $\theta = 15$ deg with $\theta = 75$ deg for specimens 19, 20, or 22 in Fig 16; or compare $\theta = 30$ deg with $\theta = 60$ deg for specimen 32.

While the data clearly indicates a degree of anisotropy, it is also clear that, for the materials under discussion, the material may be approximated as isotropic within the data scatter observed. This is an extremely important result.

4.6 Damping and Strain-Rate Effects

Figure 18 shows typical compressive cyclic stress-strain data (same specimen) ranging from a slight preload to approximately 250 psi for five strain-rates from .05 Hz to 2.0 Hz. Each figure depicts two cycles. Several extremely important observations regarding material behavior can be extracted from this data, which is typical.

First, the data clearly exhibits little or no strain-rate dependence over frequencies extending from essentially quasi-static to typical expected mode frequencies for full-scale structures [4]. Both slopes and hysteresis loops remain invariant with frequency in the above range.

Second, the hysteresis loops provide a measure of energy absorption or damping

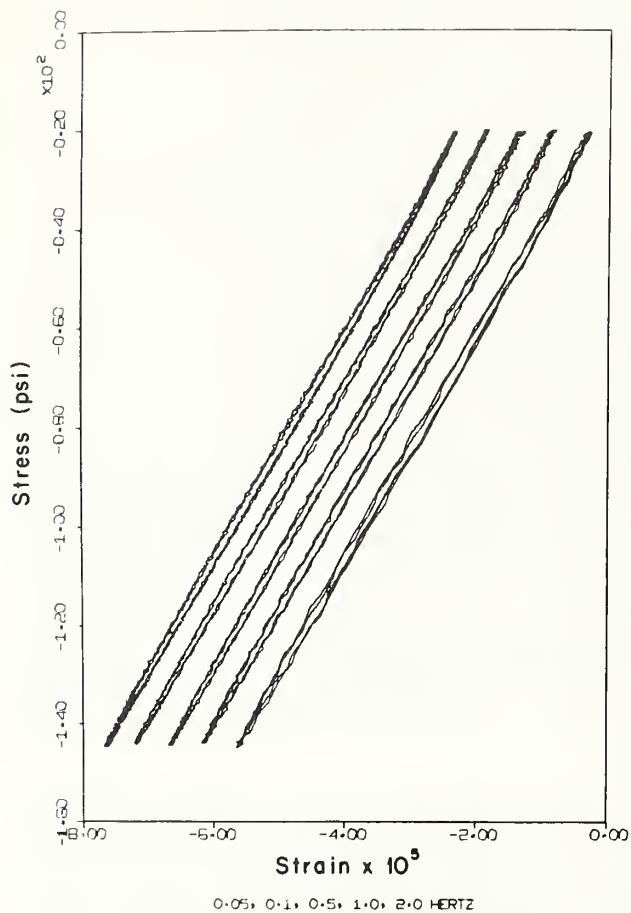

Fig. 18 Typical Panel Compressive Cyclic Data.

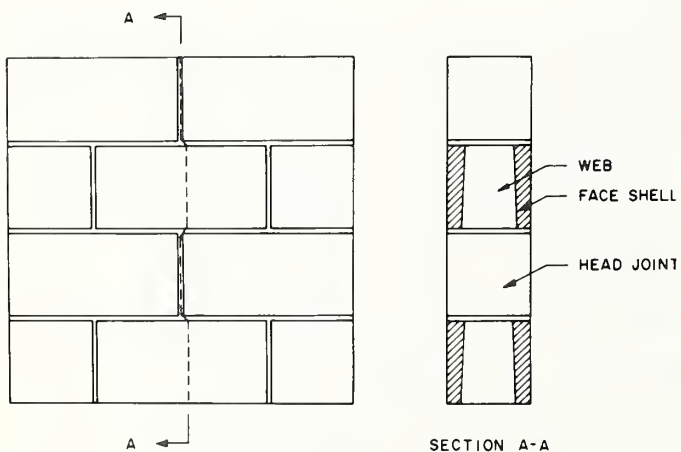

Fig. 19 Tensile Failure Pattern for 90 deg Layup Panel.



Fig. 20 Grout Bridges and Resulting Failure.

in the "linear elastic" material range. The fact that the areas of these loops do not depend upon frequency implies that material damping should not be modeled as viscous damping.

The implications of the foregoing observations may be serious. For example, the current earthquake response spectrum approach to the seismic design of buildings [5] is based upon the premise that the damping involved is of the viscous type. If the damping associated with a complete structure is the result of material behavior, then this premise is highly suspect in view of our findings. This potential problem is compounded by the fact that the response spectrum is highly sensitive to the damping assumed.

One may argue here that the first mode (or the first few modes) of a building performs as a narrow-band filter, and hence that one may approximate the structural damping mechanism as viscous wherein the damping factor is determined from data (logarithmic decrement) in the neighborhood of the modal frequency of interest. This approximation may suffice if conducted properly. Unfortunately, it does not appear that this has been the case in practice.

Consider, for example, the percent critical damping factors claimed in some masonry promotional literature [6]. Numbers ranging from 8 to 10 percent have been proposed for some masonry materials. Such information has evolved from the measurement of the rate of decay (logarithmic decrement) of material response to a transient blow from a hammer (in-plane), a steel-ball-pendulum impact [6] (out-of-plane), etc. Two things are wrong here. First, the response frequencies associated with such tests are too high-by several orders of magnitude in some cases; this results in artificially high damping coefficients (damping is known to be frequency dependent for sufficiently large frequencies). Second, and more important, the concept of critical damping has been incorrectly used. The latter is based upon the response of a single degree of freedom oscillator; the percent critical damping calculation necessitates a knowledge of the mass and frequency of this oscillator. If the oscillator is to be associated, e g, with the first mode of vibration of a building, then the effective mass and frequency must correspond to this mode. That is, the percent critical damping is a function of the assumed mass, and the modal frequency.

It is of interest to estimate how far off the above mentioned 8 to 10 percent critical damping factors are - based upon the premise that such numbers originate from the concrete masonry, and not from connections or non-structural elements. Consider Fig 18. If the damping is sufficiently small, the transient response to an initial value problem will be nearly harmonic. Suppose, as the data indicates, that material damping is independent of frequency. As in the case for viscous damping, the rate of decay curve is exponential and the decrement is a constant. The decrement for a macroelement can be calculated from Fig 18 by measuring the areas representing hysteresis and strain energy, and by computing the loss of strain energy per cycle. If this quantity does not depend on stress amplitude, then the decrement for a macroelement is the same as the decrement for a full-scale structure composed of the same material, i e, the energies of the subcomponents (macroelements) can be summed to yield the energies of the structure. Thus, one may now speak of a structural mode of vibration. The result? Critical damping factors of less than 2 percent are observed when the measured decrement is applied to an "equivalent" viscous model! Thus, if numbers such as 8-10 percent critical damping factors are to be employed in practice for concrete masonry structures, such high values must be the result of connection behavior, or some other aspect of the structure.

The above discussion concerned low stress amplitudes, i e, material response in the essentially linearly elastic range. Energy absorption and strain-rate dependence in the high stress regime is currently under study. In both cases, however, energy absorption and strain-rate dependence (if any) will be properly incorporated into the material constitutive relations.

4.7 Prediction of Macroelement Properties from Component Properties

From a practical standpoint, it is imperative that one be able to predict basic macroelement properties from component properties. Extensive testing has indicated that this is indeed possible. Several examples are provided below with respect to the failure surface described previously.

Consider the failure theory of Fig 10. This theory requires material isotropy and two data points: the uniaxial compressive and tensile strengths for, say, a 0 deg layup. The compressive strength may be determined from four or five-course prism data. Likewise, the tensile strength can be estimated by direct tensile testing of prisms. The above strengths may also be estimated from component properties.

Consider Fig 15. The open square, which represents the mean of repeated tests, is the result of a direct tensile - prism testing of "batch 6". This data is observed to provide a good 0 deg tensile strength estimate, and is conservative in that it lies below the actual macroelement (panel) data. (This is due to the increase in flaw sensitivity with a decrease in specimen size).

The open triangle at 0 deg layup angle in Fig 15 is based upon the premise that (in the absence of bond beams), 0 deg tensile strength is determined solely by the grout tensile strength and grout area (no tensile strength is attributed to the mortar bond - a fact which has been substantiated by joint tests). The strength estimate is seen to be excellent.

The strength of a 90 deg layup specimen in tension is primarily a function of block strength. A typical failure pattern is illustrated in Fig 19. The head joints contribute little strength, and inspection of failed specimens revealed that most grout cores separated cleanly from the webs. But usually one web was failed, and adding that area to the area of the face shells gives the estimate of macroelement strength at 90 deg shown as the open triangle in Fig 15. The estimate is seen to be quite accurate. Whether the bonded area, and hence macroelement strength, can be predicted is being studied. Block strength here was determined by direct tensile testing of coupons sawcut from full-blocks.

The above two tensile strength estimates provide the necessary measure of anisotropy.

The estimate of macroelement compressive strength from the component properties is not quite so straightforward. The latter is currently under study.

It should be noted that a model for the statistical distribution of data from brittle

materials such as those under study requires a substantial number of macroelement tests for its development. No material description is, of course, complete without such a model.

Finally, an effort is also underway to predict elastic properties of macroelements from component properties. The latter will not be discussed here, however.

4.8 The Influence of Flaws, Compaction, Admixtures

Specimen sawcutting has afforded an unusual opportunity to observe flaws. Such cuts reveal much more information than cores, although cores are also taken in our tests.

To date some seventy macroelements have been tested. Virtually every specimen has exhibited flaws in the form of grout-block separation, voids, and most important - shrinkage cracks forming grout bridges. Figure 20 dramatically illustrates such flaws - and the fact that they can prematurely trigger failure.

With respect to block-grout separation - it is known that several mold release agents are used in the construction of concrete block. It is suspected that such agents adversely influence grout-block bonds. This matter is under investigation.

In an effort to mitigate the grout shrinkage/bridging problem, several grouting techniques are currently under study: (1) puddling of grout; (2) compaction and recompaction of grout via vibration; (3) and the use of grout admixtures with and without compaction. Figure 21 illustrates the influence of each technique on full-scale panels sawcut from 8x8-foot fully grouted walls. It can be observed that vibration compaction yields a specimen superior to puddling with or without admixture (the admixture in this case is Suconem G A (Grout Aid)).

Additional information on this subject can be found in Section 5.2.

4.9 The Influence of Reinforcing Steel

The influence of reinforcing steel in the control of macrocracking, and on the nonlinear, post macrocracking stress/strain range is of major concern in our studies.



Fig. 21(a) Sides of Panels: Puddled; Admixture Puddled; Vibrated; Admixture Vibrated.

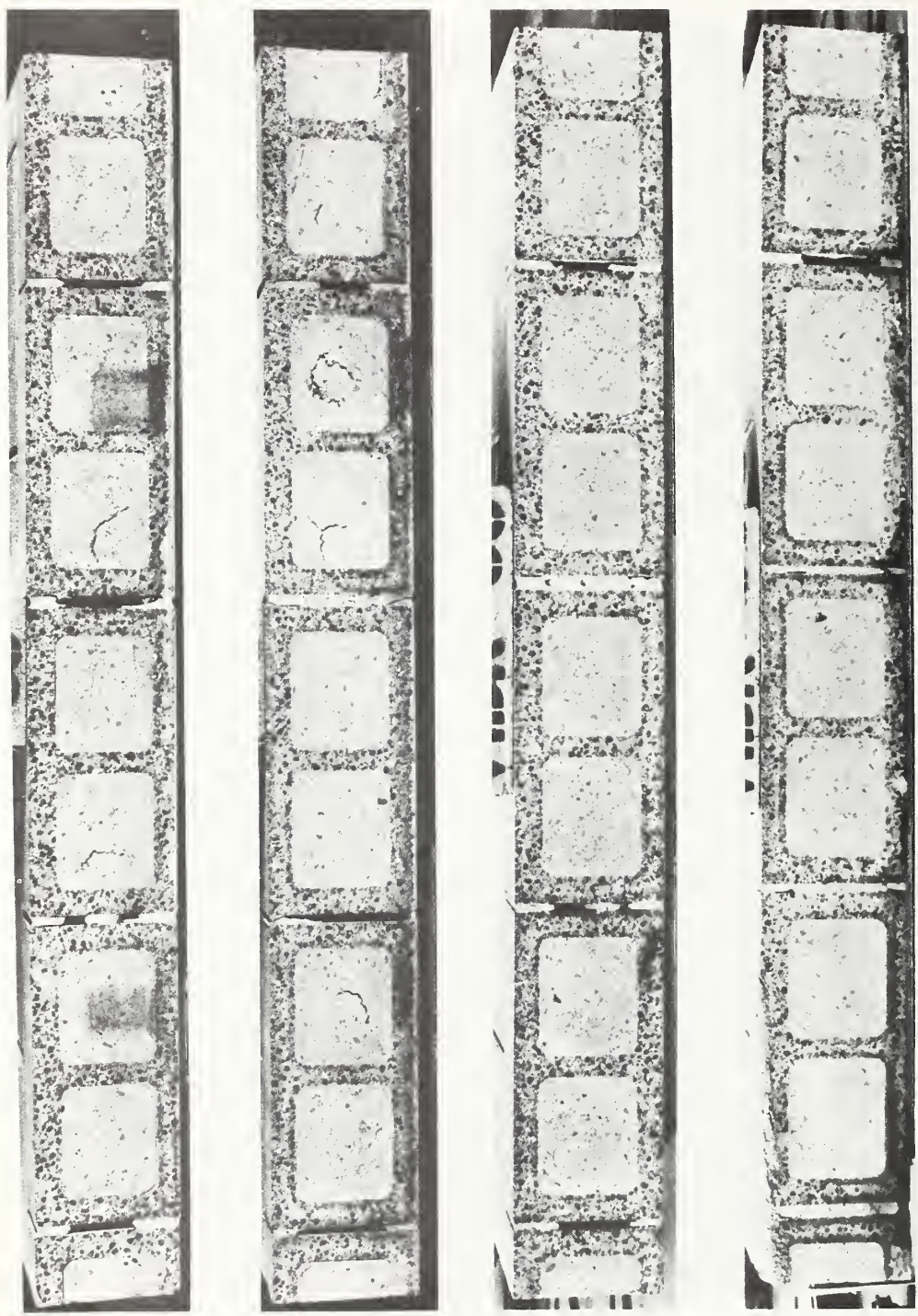

Fig. 21(b) Tops of Panels: Puddled; Admixture Puddled; Vibrated; Admixture Vibrated.

Current tests involve fully grouted specimens with two number five bars (grade 60) at 32 inches on center - both vertically and horizontally. The area of the steel in each direction is 0.6 in^2 , whereas the net cross sectional panel area is 487 in^2 ; this yields a steel/masonry ratio of .00126 in each direction, which exceeds minimum UBC requirements.

The reinforced concrete masonry tests are currently in a production mode, and it is perhaps premature to discuss results. However, several items are noteworthy:

First, the initial macrocracking stress level does not appear to be significantly influenced by steel/masonry ratios of the magnitude under discussion. Thus, failure envelopes, Fig 10, as determined from unreinforced tests should predict the onset of macrocracking.

Second, under monotonically increasing strain, a substantial drop in the macro-element stress occurs at the onset of macrocracking, i e, the load-carrying capability dramatically decreases. This is illustrated in Fig 22 for a typical 0 deg uniaxial test under displacement control. This drop is associated with load transfer from masonry to steel, and the fact that the steel area is not sufficient to maintain the original load without considerable extension.

Third, upon continued straining of the specimen, reloading is observed - the slope of which is smaller than that of the masonry, but larger than that associated with the steel alone. This implies that the load is shared by both steel and masonry.

Fourth, upon cyclic straining from zero to a tensile strain, stiffness degradation can be observed, Fig 22. This degradation is associated with multiple cracking (see Fig 23) in contrast to a single crack observed at the failure point of unreinforced specimens. (The crack marked "1" denotes the initial macrocrack associated with the peak load of Fig 22).

It is clear at this stage of research that the amount of steel utilized in most construction is not sufficient to prevent an unstable branch of the stress-strain curve associated with a reinforced macroelement.

In passing, it is noted that specimen fixturing was designed to provide a uniform

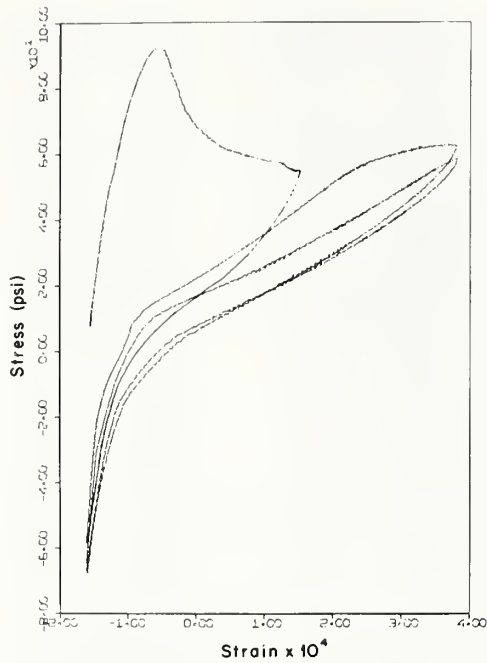

Fig. 22 Reinforced Panel Failure and Post-Failure Cycling.

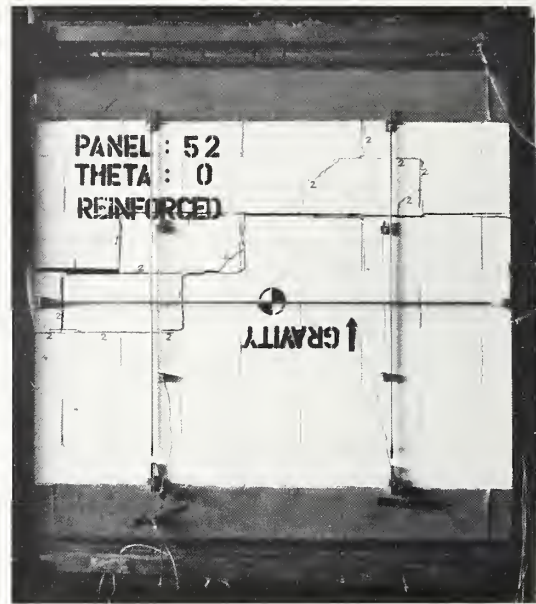

Fig. 23 Multiple Cracking of Reinforced Panel.

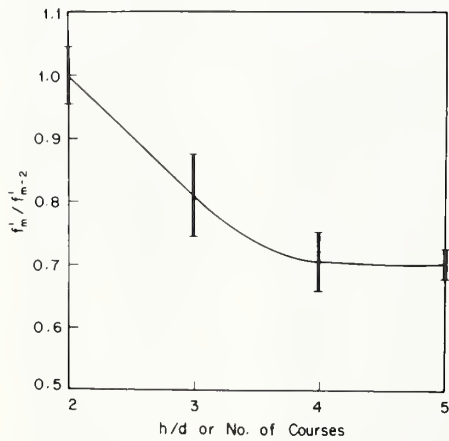

Fig. 24 Correlation of Prism Strength and Geometry.

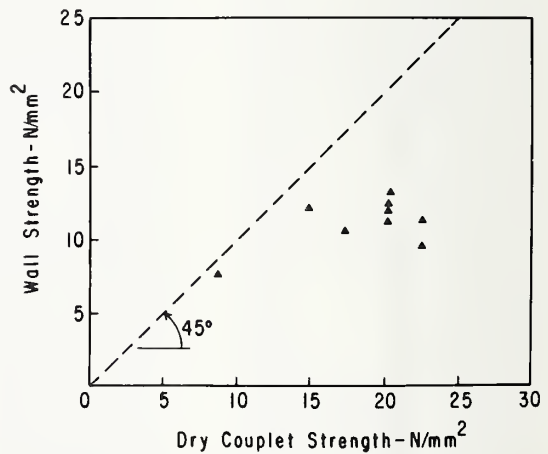

Fig. 25 Comparison of UngROUTED Wall and Couplet Strengths.

strain field in both steel and masonry prior to macrocracking. Proper loading of the steel is not a trivial matter experimentally, and no attempt will be made here to explain the fixture details.

V. SELECTED RESULTS - PRISMS

Once again, a complete description of small-scale tests is beyond the scope of this paper. Below, representative tests and sample results are provided in order to give the reader a proper perspective of the program.

5.1 Influence of Number of Courses on Strength

Present working stress and design methods are based primarily upon a knowledge of the masonry compressive strength, f'_m . In practice, f'_m is usually determined by prism tests. Current masonry codes and design recommendations (see reference [1]) either explicitly or implicitly recommend that f'_m be computed on the basis of 2-course prisms laid in stacked bond, and capped according to ASTM C140 wherein a sulfur fly-ash compound or a high strength gypsum plaster is used. Test procedures correspond to ASTM E447. Code correction factors purport to enable conversion of the strength of a particular geometry to that of a standard prism. A UBC correction factor of unity is presently applied to the 2-course prism ($h/d = 2.0$). This evidently implies that a strong correlation with $h/d = 2.0$ and full-scale masonry exists. Our research clearly indicates this premise to be false and nonconservative. In particular, test data indicates that prism strength is significantly influenced by load-platen restraint and, in the absence of a soft capping material, is a strong function of the number of courses-up to four-to-five courses. A typical example is illustrated in Fig 24. The data was obtained from full-block, fully grouted specimens; precision cutting to the desired h/d ratio was utilized in place of a high-strength capping material. The bearing platens at each end consisted of solid 8x8x16-inch aluminum blocks. Platen restraint resulted in a shear-mode failure in 2-course prisms, and combined shear-tensile splitting in 3-course prisms. Proper

tensile splitting was observed in 4 and 5-course prisms. Based upon the 5-course data, the 2-course results are approximately 50 percent too high. Also, the data indicates that prism strength is a function of the number of joints in the specimen as well as the h/d ratio. Finally, an extensive literature review (see Reference [1]) revealed an amazing fact: Virtually all code correction factors for prism geometry are based upon a common source - the preliminary and exploratory investigation by Krefeld in 1938 (see reference [1]) - on brick! This is patently unjustified. A correlation of Krefeld's work with a number of codes is shown in Table 2 (each code is based upon a different "standard" prism geometry-hence the normalization factor may be different). In view of the above discussion, one would expect poor correlation between 2-course prism and wall data; this is demonstrated by tests by Read and Clements on ungrouted walls, Fig 25 (see Reference [1]). The component materials for the specimens discussed above are described in Table 3.

5.2 Influence of Compaction, Admixtures on Compressive and Tensile Strengths

The extensive flaws observed in full-scale masonry led to a comprehensive study of the influence of compaction and/or admixtures on flaws-and hence on strength. One such study is briefly described below. The component properties associated with these tests are described in Table 1.

Table 4 compares compressive strengths obtained from 4-course prisms (full block, fully grouted, stacked bond) consisting of four test types: (1) puddled grout (marked STD); (2) vibrated grout (marked STD VIBR); (3) puddled grout with an admixture (Suconem G A or Grout Aid; marked ADM); and (4) vibrated grout with an admixture (Grout Aid; marked ADM VIBR). A significant difference was observed between puddled and vibrated specimens; the former was only 66 per cent as strong as the latter. The addition of grout aid in these tests appears to improve strength - with or without vibration. This last point is being reexamined for small-scale specimens, and a panel test-series is underway to verify the influence of Grout Aid in full-scale masonry.

Table 2. Comparison of Correction Factors for Prism Shape after "Code Factor" Modification.

Source	"Code factor"	h/d=						
		1.5	2.0	2.5	3.0	4.0	5.0	6.0
Krefeld	—	0.59	0.67	0.75	0.80	0.89	0.96	1.00
New Zealand Standard	1.50	0.58	0.67	0.74	0.80	0.89	0.95	1.00
Australian Standard	1.25	—	0.68	0.74	0.80	0.88	0.93	0.93
Canadian Code (concrete)	1.50	0.57	0.67	0.74	0.80	—	—	—
Canadian Code (brick)	0.93	—	0.68	0.74	0.80	0.89	0.93	—
Uniform Building Code	1.50	0.57	0.67	0.74	0.80	—	—	—
National Bureau Standards	1.50	0.57	0.67	0.74	0.80	—	—	—
Structural Clay Prods. Inst.	0.93	—	0.68	0.74	0.80	0.89	0.93	—

Table 3. Component Properties for Prism Geometry and Interface Tests.

	Block	Mortar	Grout
	2080	3780	5380
	2320	4580	5780
	3260	3780	5770
Compressive	2570	4260	
Failure Stress	3320		
(psi)	2450		
	3210		
	3210		
	2680		
	2400		
mean	2750	4100	5640
std. dev.	460	390	230
	1.74	0.86	1.68
	1.47	0.98	2.13
Young's Modulus [†]	1.89	0.81	1.44
(10 ⁶ psi)		0.85	1.83
mean	1.70	0.88	1.77
std. dev.	.21	0.07	.29

[†]Tension for block, compression for mortar and grout

Table 4. Compressive Strength for 4 - Course Grouted Prisms.

	STD	STD VIBR	ADM	ADM VIBR
	1348	2274	2181	2004
	1449	2426	2350	2282
Failure Stress f_c	1398	2089	2324	2173
(psi)	1887	2434	2308	2148
	1490	2358	2450	2468
mean	1524	2316	2323	2215
std. dev.	212	142	96	173

Table 6. Ratio of Prism Tensile to Compressive Strength.

	STD	STD VIBR	ADM	ADM VIBR
f_t/f_c	.059	.047	.045	.051

Table 5. Tensile Failure Strength for 3 - Course Grouted Prisms.

	STD	STD VIBR	ADM	ADM VIBR
	69.7*	116.3*	92.5*	94.8*
Failure Stress f_t	111.2	91.8	110.7	98.6
(psi)	111.2	127.3*	118.3	116.3
	84.3*	113.0	110.4	143.2
	69.9	89.9	95.8	107.4
mean	89.3	107.7	105.5	112.1
std. dev.	20.9	16.3	10.9	19.3

*Polymer bond (all others epoxy bond)

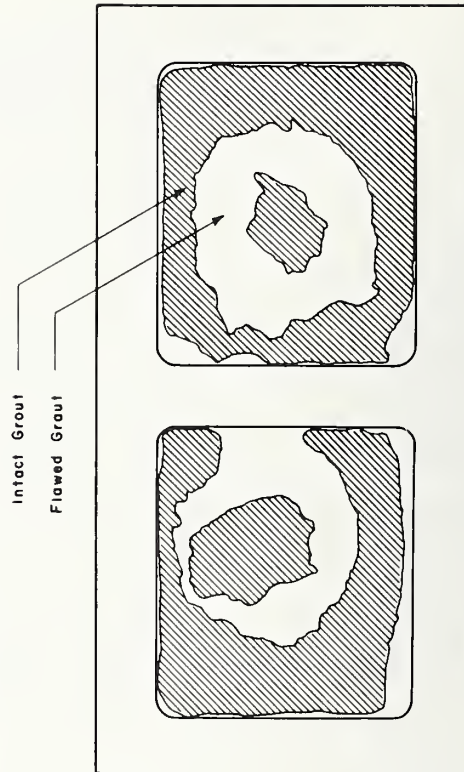

Fig. 26 Grout Flaws at Bed - Joint Plane.

Table 5 compares tensile strengths (measured directly from 3-course prisms laid in stacked bond and fully grouted). Again, it is evident that vibration compaction is significantly superior to puddling. Admixture tests are under reevaluation, as noted above.

5.3 Ratio of Tensile to Compressive Strengths

The tensile strength of plain concrete is approximately 0.1 times the compressive strength. The data of Table 6, obtained from the foregoing test series, shows that the ratio of tensile to compressive strength for concrete masonry (referred to bed joint planes) is approximately 0.05. The reason? The mortar bonds furnish virtually no tensile strength, the grout core takes the tensile load, and the ratio of grout area to the total cross sectional area is approximately a factor of two.

5.4 Influence of Flaws

The influence of flaws is implicitly exhibited in the data of Tables 4 and 5. That is, vibration compaction and admixtures tend to reduce the number of flaws and hence to increase strength.

An explicit, dramatic flaw influence, however, is worth noting at this point. Upon examination of the surface associated with a failed, puddled prism (failed in tension) with no admixture, the cross-hatched area of Fig 26 was deduced to be free from flaws, i e, the remaining area represented a flaw in which no bond existed across the plane of failure. Based upon the measured tensile strength of the grout, and the measured area of integrity, the tensile strength of the prism was predicted exactly. Hence there can be no doubt that flaws significantly influence masonry strength.

It should be noted that a definite scale effect has been observed with respect to flaws. This point, which was mentioned under Section 4.7 is such that small specimens, such as prisms, are more flaw sensitive than full-scale specimens, such as panels.

5.5 Elastic Moduli

Typical initial tangent moduli based upon the 3-course tension tests described previously are shown in Table 7. These data are in good agreement with full-scale panel data. Failure-point secant moduli are also provided in Table 8. Measurements were conducted as illustrated in Fig 27.

Of considerable interest, from the standpoint of nondestructive testing, is the ratio of moduli to strength. Typical data on this subject is provided in Table 9.

5.6 Prediction of Compressive Strength from Component Properties

Whereas the tensile strengths of either prisms or panels can be estimated from component properties, Tables 3 and 4 indicate that the situation is not as simple for the case of compression. Note that the component compressive strengths in Table 1 exceed the prism compressive strength. This matter is currently under investigation.

VI. SELECTED RESULTS - INTERFACES

6.1 Materials

The component materials for this test series are described in Table 3. Grouted specimens were compacted by puddling.

6.2 Joint Behavior

Data on joint fracture and post-fracture behavior is a prerequisite to a basic understanding of failure processes, and is necessary for modeling on the micro-scale. A typical test-setup for monotonic loading of full-blocks is illustrated schematically in Fig 28. In each test a constant normal stress was maintained across joint-planes, and the shear-stress distribution on these planes was varied by driving the center block in displacement control. Figures 29 and 30 exemplify typical static and dynamic⁷ behavior

⁷The dynamic test fixture is complex and is not shown here.

Table 7. Initial Tangent Modulus for Prism Tension Test.

	STD	STD VIBR	ADM	ADM VIBR
$E_T(10^6 \text{ psi})$	1.86	2.13	2.14	2.27
	2.01	2.04	1.96	1.92
	1.97	1.97	2.12	2.12
	1.43	2.13	1.87	1.99
	1.56	2.10	1.80	2.05
	mean	1.77	2.07	1.98
std. dev.	.26	.07	.15	.13

Table 8. Failure - Point Secant Modulus for Prism Tension Test.

	STD	STD VIBR	ADM	ADM VIBR
$E_S(10^6 \text{ psi})$	1.17	1.37	1.57	1.56
	1.51	1.26	1.70	1.33
	1.36	1.29	1.87	1.64
	1.10	1.68	1.66	1.59
	1.20	1.42	1.63	1.73
	mean	1.27	1.40	1.69
std. dev.	.17	.17	.11	.15

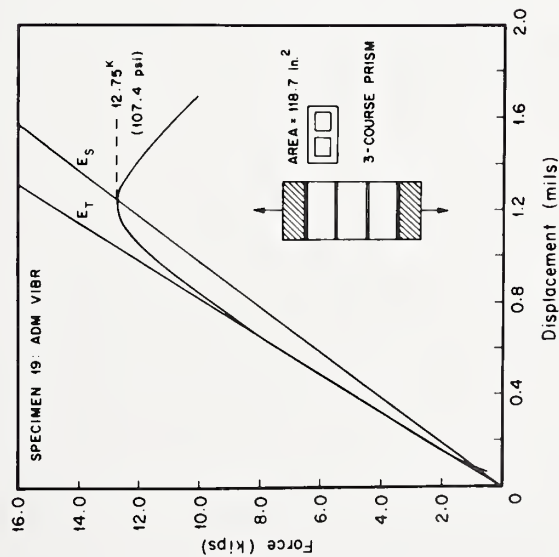

Fig. 27 Typical Prism Tensile Failure Test.

Table 9. Ratio of Prism Strength to Initial Tangent Modulus for Tension Test.

	STD	STD VIBR	ADM	ADM VIBR
$\frac{f_t}{E_T} \times 10^6$	37.5	54.6	43.2	41.8
	55.2	45.0	56.5	51.4
	56.5	64.6	55.8	54.9
	58.9	53.1	59.0	72.0
	44.8	42.8	53.2	52.4
	mean	50.6	52.0	53.5
std. dev.	9.1	8.7	6.1	11.0

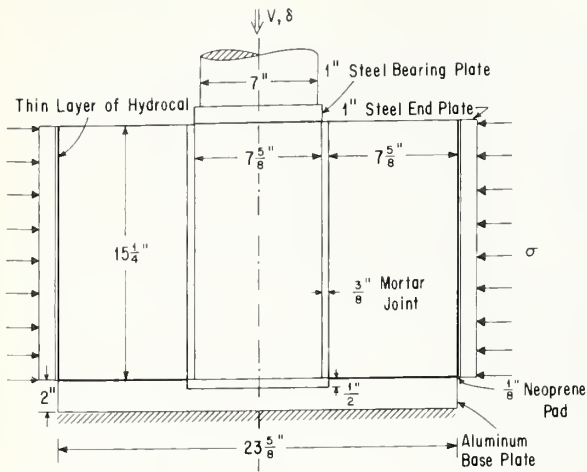

Fig. 28 Joint Test Setup.

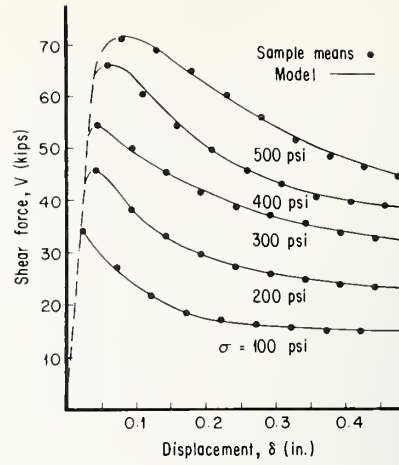

Fig. 29 Behavior of Bed Joints Under Precompression.

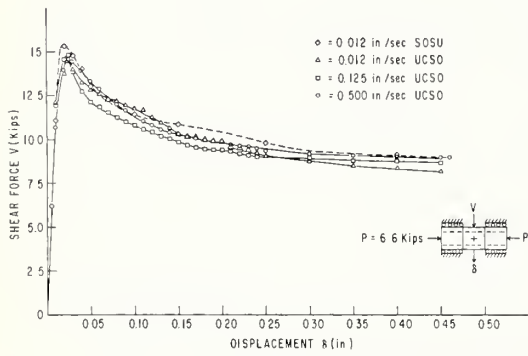

Fig. 30 Strain-Rate Dependence.

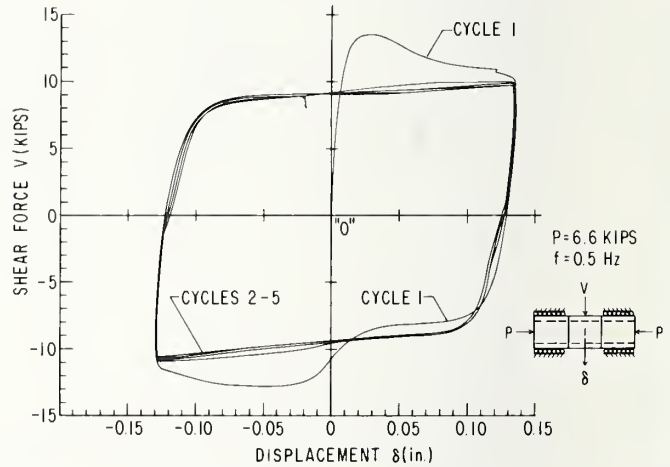

Fig. 31 Joint Behavior Under Cyclic Loading.

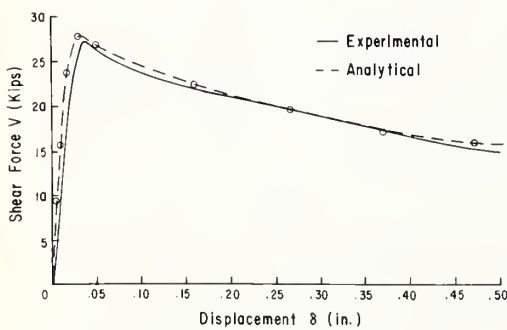

Fig. 32 Finite Element Simulation of Joint Behavior.

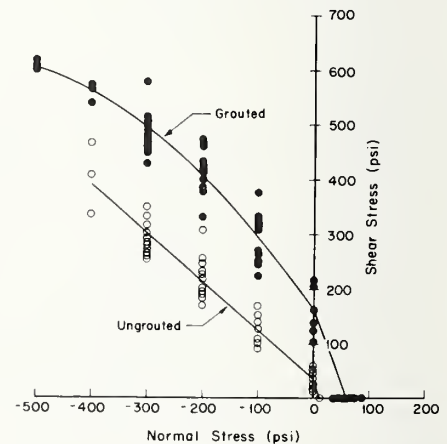

Fig. 33 Dependence of Joint Maximum Shear Stress on Normal Stress.

for grouted and ungrouted bed joints. The following basic characteristics are noted:

(1) joint fracture strength increases monotonically with precompression up to a block-failure transition (the maximum shear stress vs normal stress for both grouted and ungrouted specimens is shown in Fig 33); (2) under precompression exceeding 100 psi-fracture load decreases with displacement (Fig 29) in a relatively smooth manner to a limiting value which, in turn, depends upon the level of precompression; (3) no discernible rate-dependence is evident in the ranges .01 to .50 in/sec under monotonic loading (Fig 30) and in the range .05 to .50 Hz under cyclic loading; (4) cyclic experiments (Fig 31) indicate that, following the first load reversal, load-displacement history is a function only of total displacement-path length and is not direction-sensitive; (5) ultimate strengths of head joints, and ungrouted bed joints are considerably less than associated grouted bed joints; (6) in the absence of precompression, joint behavior is brittle - ungrouted bed and head joints exhibit extremely low (3-30 psi) shear and tensile strengths as well as large data-scatter.

Joint shear force V vs displacement δ data suggested that the post-fracture regime could be represented by solutions of the differential equation

$$dV/d\delta = -c[V(\delta) - V_{\infty}] \quad (5)$$

where V_{∞} denotes the asymptote at "infinite" displacement and c is a function of the work $W(\delta)$ done up to the displacement δ , viz,

$$W(\delta) = \int_{\delta_1}^{\delta} V(\delta')d\delta' . \quad (6)$$

Using the following solution of (5),

$$[W(\delta) - V_{\infty}]/[V_1 - V_{\infty}] = \exp[-\{\bar{c} \int_{\delta_1}^{\delta} [W(\delta')]^{1/3} d\delta' + b\}] \quad (7)$$

where δ_1 corresponds to the maximum shear for V_1 , a nonlinear regression method was developed to determine the constants \bar{c} , b , and v_{∞} , and the correlation shown in Fig 29 was obtained. The points denote statistical means from at least three tests. Agreement is remarkable.

Finite element simulation of the joint tests was performed as a first step in the micro-modeling process. Local properties were established which enabled the analysis to match the experimental V vs δ data and which are reasonable when judged against independent measurements of interface strength. A typical correlation for ungrouted bed joints is shown in Fig 32. Agreement is seen to be good. Details of this work are contained in reference [3]. Subsequent to "tuning" the simulation of joint data, the above finite element model was utilized to predict biaxial panel behavior without further "tuning".

VII. CLOSURE

The program described, in part, herein represents the first fundamental and comprehensive effort to describe the material properties of concrete masonry.

The experimental apparatus necessary to generate data with integrity is, of necessity, complex and sophisticated. A time span of approximately two years has been necessary to bring all systems to a production basis. An avalanche of important results is now taking place.

While modeling was not discussed, excellent correlation has been obtained to date between experimental results and finite element simulations or modeling on the micro scale. In particular, it appears that the macro-behavior of concrete masonry can be rationally predicted from masonry constituent properties.

Finally, masonry is some 20 years or more behind concrete with respect to knowledge of material properties. Such a gap cannot be closed overnight. It is imperative that programs of the type discussed in this paper be sustained for a time period sufficiently long to allow the effort to come to fruition.

It is also imperative that the masonry industry organize on a national basis - much as the concrete industry has - if progress in this area is to be made within a reasonable time period. The absence of comprehensive knowledge concerning fundamental material properties - if allowed to continue - can only invite potentially enormous safety and economic problems.

REFERENCES

1. Hegemier, G. A. , "Mechanics of Reinforced Concrete Masonry: A Literature Survey," Report No. AMES-NSF-TR-75-5, University of California, San Diego, 1975.
2. Mayes, R. L. , and Clough, R. W. , "A Literature Survey - Compressive, Tensile, Bond and Shear Strength of Masonry," Report No. EERC 75-15, University of California, Berkeley, 1975.
3. Arya, S. K. , "A Method for Incorporating Interface Discontinuities in Finite Element Analyses with Application to Concrete Masonry Rheology," Weidlinger Associates Report No. R-7522, prepared for the University of California, San Diego, 1975.
4. Krishnamoorthy, G. , G. A. Young, and G. A. Hegemier, "Prediction of the Torsional Response of a Multistory Reinforced Concrete Masonry Building by a Three-dimensional Dynamic Analysis," Proceedings of Fifth World Conference on Earthquake Engineering, Vol. 1, No. 13, Rome, 1973.
5. An Evaluation of Response Spectrum Approach to Seismic Design of Buildings, A Study Report for Center for Building Technology, Institute of Applied Technology, National Bureau of Standards, Washington, D. C. , 20234, by Applied Technology Council (ATC-2), San Francisco, California, September, 1974.
6. Dickey, W.L. and Harrington, R.W., Report - "The Shear Truth About Brick Walls", Western States Clay Products Association, Inc., San Francisco, 94105, 1970.

AN EXPERIMENTAL STUDY OF CONNECTIONS IN REINFORCED CONCRETE MASONRY
MASONRY STRUCTURES UNDER SEISMIC LOADING

J. Isenberg¹, G. A. Hegemier², A. Anvar³

ABSTRACT

This paper describes a University of California, San Diego test program to determine the behavior of typical floor-to-wall connections utilized in reinforced concrete masonry structures. The experiments are part of an extensive research effort on the seismic response of reinforced concrete masonry buildings.

I. INTRODUCTION

A research program to investigate the properties of reinforced concrete masonry under seismic loading is being carried out under sponsorship of NSF/RANN. The experimental portion of the program aims to obtain the stiffness and strength characteristics of such basic structural units as shear wall panels and floor-to-wall connections. In the laboratory, uniform forces and displacements are applied so that average stress/strain and strength properties are obtained for the specimens. These are regarded as units in complex structural systems whose behavior eventually will be predicted by mathematical models based on the laboratory tests. A test program for masonry panels is already well underway.

The next phase of the test program focuses on floor-to-wall and wall-to-wall connections. The function of such connections is shown in Figure 1. Tests are about to

¹ Associate, Weidlinger Associates, Suite 245, Building 4, 3000 Sand Hill Road, Menlo Park, Calif., 94025.

² Prof., University of California, San Diego, AMES Department, La Jolla, Calif., 92093.

³ Graduate Student, University of Calif., San Diego, AMES Department, La Jolla, Calif.

start on floor-to-wall connections under cyclic loading. The tests will be conducted in an existing frame which has been extensively used for testing panels. Three different connection types have been selected for initial study. Other types and details may be considered later. This paper summarizes the planned test program for connections

II. TEST PROGRAM

The tests on connections will be conducted in the frame shown in Figure 2. The philosophy of the test is to prevent horizontal displacements of the wall panel while applying oscillatory horizontal motion to the floor. Constant force is applied in the vertical direction to simulate the weight of stories above the test floor; eventually, an oscillatory vertical force may be superposed on this constant to simulate the effects of overturning on the test wall. The objective is to obtain reasonably uniform horizontal shear stresses and vertical normal stresses on the plane of the connection. The strength and horizontal force-deflection relationship, including a falling or softening branch, if any, are the main quantities of interest.

An advanced, computer-controlled servo system will be used to control the hydraulic actuators which apply the loads and displacements. All loads on the wall and the floor slabs are applied through aluminum edge members or "Logs". At the bottom of the test specimen, Log A in Figure 3, the absolute displacement of the four jacks will be controlled (i. e., stroke control) from LVDT's. At the top of the specimen, Log B in Figure 3, the forces in the four jacks will be prescribed via load cells to simulate the weight of stories above. At the left hand side, Log C in Figure 3, no horizontal displacement will be allowed (i. e., stroke control); and load cells will measure horizontal force. At the right hand side, Log D, horizontal forces equal to those at Log C will be applied; thus, the horizontal load on the specimen will be shared equally (half in tension, half in compression) by the horizontal actuators. The loads in the actuators connected to Log D, will be servo-controlled on the basis of the load recorded at Log C. Logs are bonded to the specimen by a polymer which is capable of transmitting tensile forces of

about 60 to 70 kips hence, shear forces of 120 to 140 kips can be resisted by the arrangement described above. If higher shear forces are needed to break the connection, the test procedure will be modified.

Oscillating relative horizontal displacements between the wall and floor sections will be prescribed to simulate the inertia of floors in earthquakes. The relative displacements will be measured by mounting LVDT's on the floor panel and companion brackets on the wall. The measurement will be compared with a prescribed one and the forces in jacks connected to Logs E and F of Figure 3 will be adjusted accordingly. Forces on the floor will be tension on one side and an equal compression on the other. This will provide as uniform a distribution of shear stresses, in the plane of connection, as is possible to achieve.

The types of connections to be tested have been selected on the basis of discussions with several California structural engineers who are intimately familiar with seismic provisions of building codes. Although there is disagreement among practicing engineers as to what details are most commonly used, there is a consensus that the types of connections illustrated below are common.

The first major type of connection, to be tested initially, involves precast, reinforced concrete slabs supported by an interior masonry wall. Two construction details are shown in Figures 4 and 5. In the construction detail of Figure 4, bars embedded in the slab are bent up at 36" spacing and embedded in the grout core, with one continuous No. 5 chord. All cells of the wall are grouted. A much simpler detail is shown in Figure 5, in which there is only one continuous No. 5 chord and shear transfer is provided through the bond between the slab and the masonry wall by shear keys.

The second major connection type involves a cast-in-place slab supported by an interior masonry wall, Figure 6. Bars embedded in the top and bottom of the slab are continuous through the grout core. A continuous No. 5 chord is also set in the plane of connection. All cells of the wall are grouted.

The third major connection type shown in Figure 7, involves hollow core,

prestressed concrete planks supported by an interior masonry wall. In this detail, in addition to the common No. 5 chord in the grout, there are continuous bars in the concrete topping, poured on the slabs. As in the other details, all cells of the wall are grouted.

The test matrix is shown in Table 1. It is planned to begin the test series with a constant vertical load (dead load only).

Table 1. Connection test matrix

	VERTICAL DEAD LOAD ONLY		VERTICAL DEAD LOAD WITH OVERTURNING MOMENT
	<u>Mid Rise</u>	<u>High Rise</u>	<u>High Rise Only</u>
Precast slab to interior wall			
Detail #1	100-200 psi	200-500 psi	400 ± 200 psi
Detail #2	100-200 psi	200-500 psi	400 ± 200 psi
Cast-in-place slab to interior wall			
Detail #3	100-200 psi	200-500 psi	400 ± 200 psi
Prestressed conc. plank & topping floor to interior wall			
Detail #4	100-200 psi	200-500 psi	400 ± 200 psi

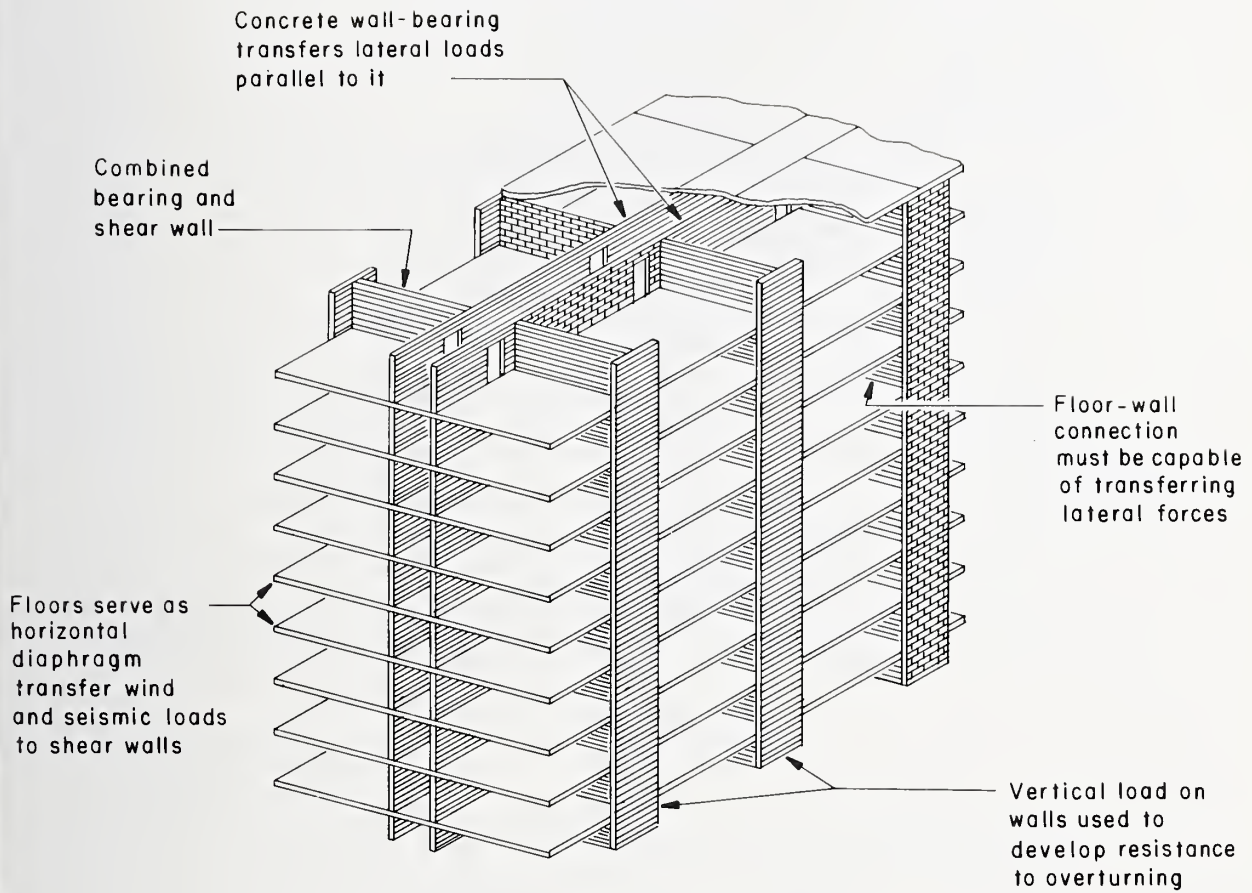
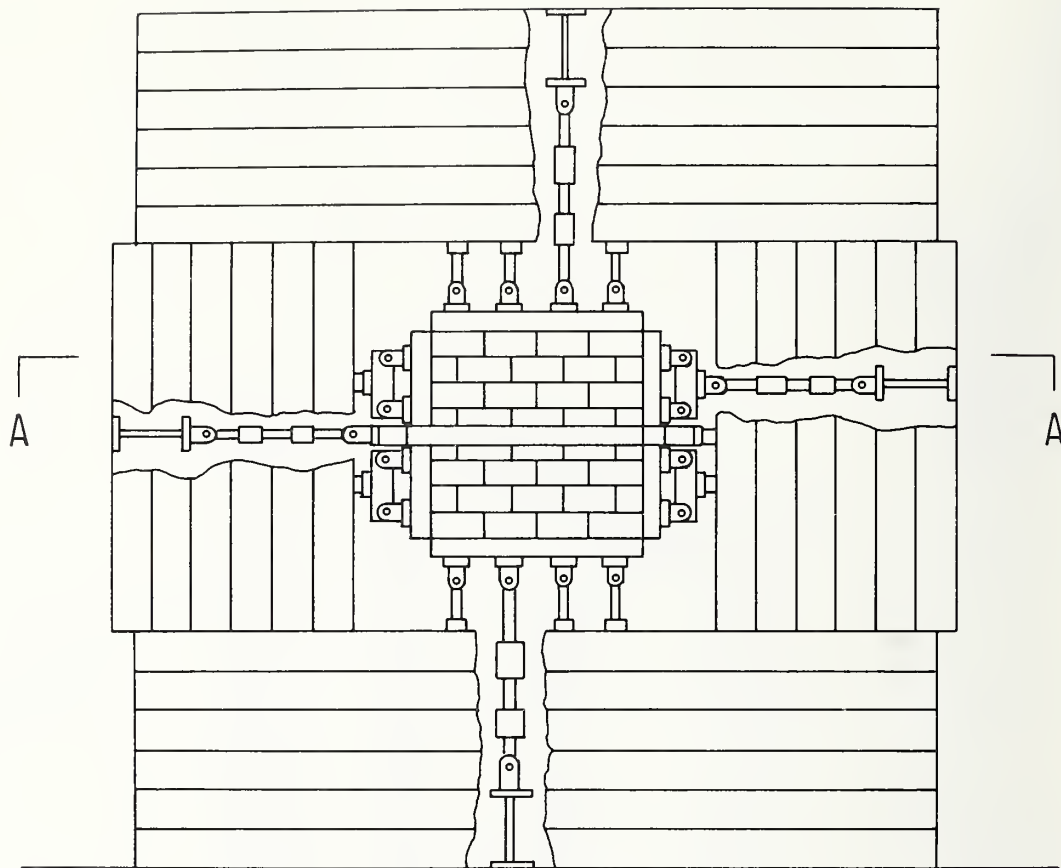
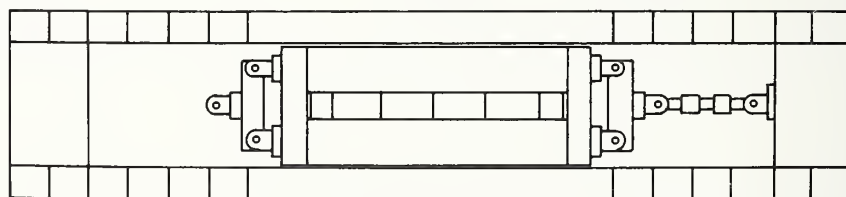

Fig. 1. Function of connection in shear wall structure.



ELEVATION



SECTION A-A

Fig. 2. Connection test set-up.

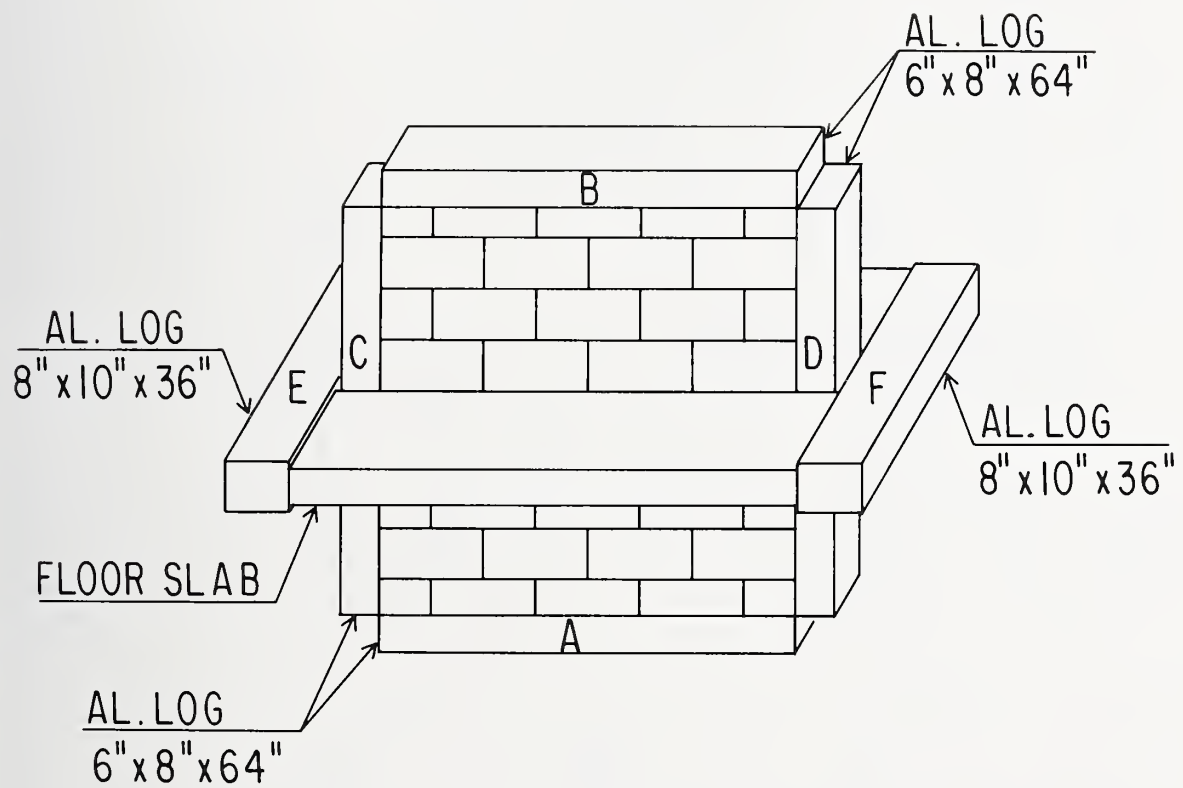

Fig. 3. Connection specimen and edge members.

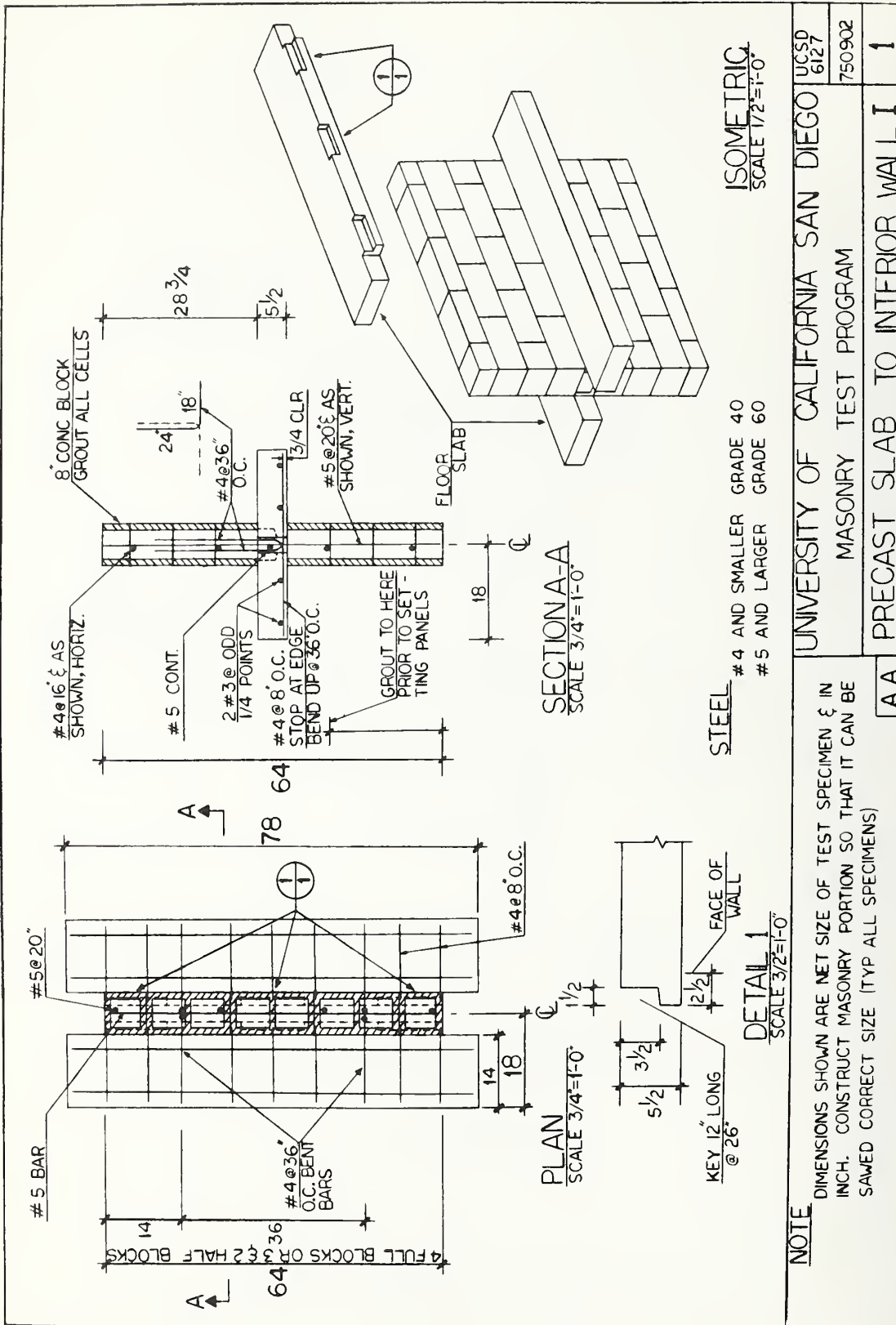
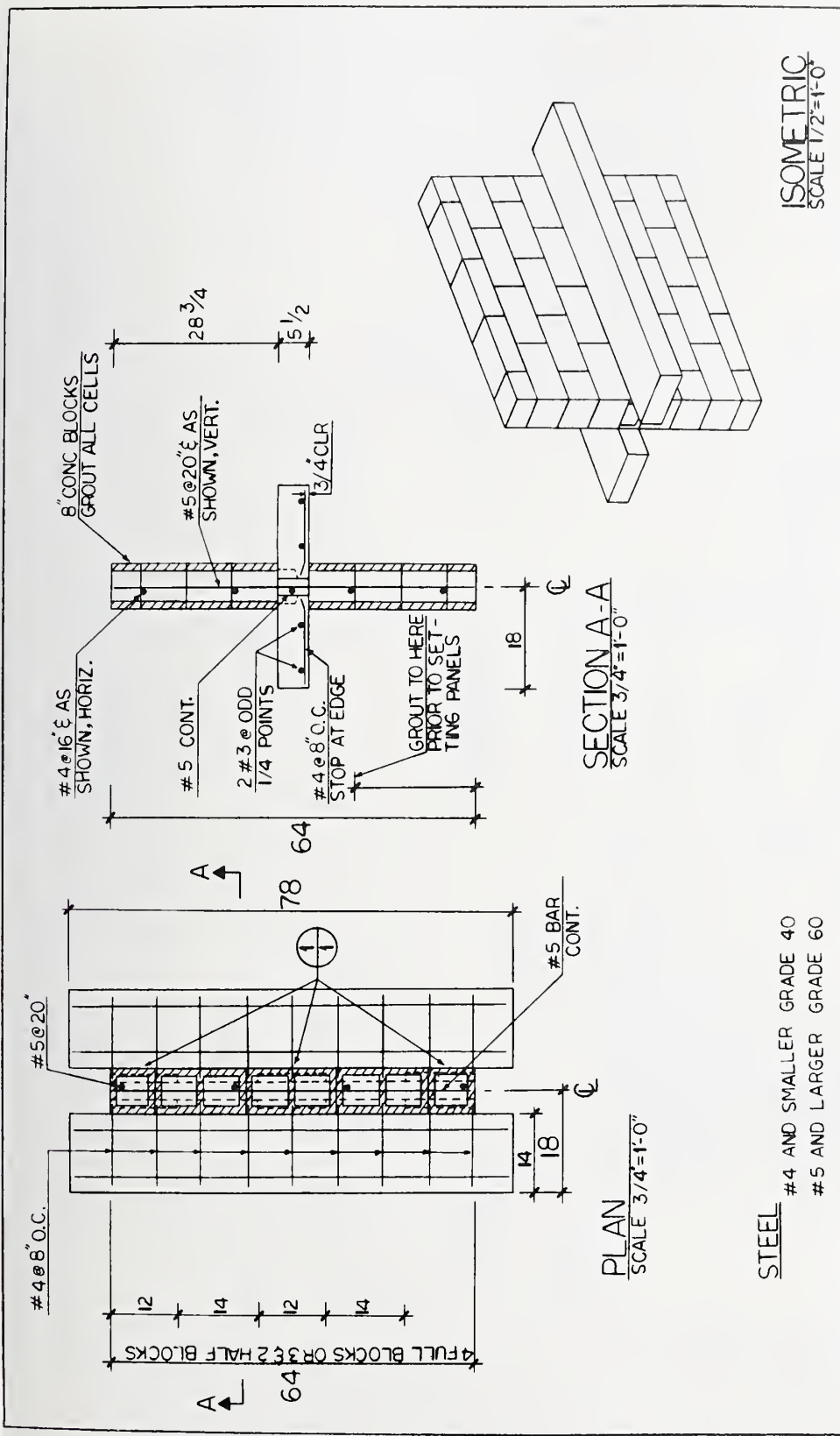

Fig. 4. Connection detail of precast floor slab and interior wall, detail 1.



UNIVERSITY OF CALIFORNIA SAN DIEGO	UCSDP
	6127
MASONRY TEST PROGRAM	750902
A.A.	PRECAST SLAB TO INTERIOR WALL II
	2

STEEL
 #4 AND SMALLER GRADE 40
 #5 AND LARGER GRADE 60

NOTE
 SEE SHIT. # 1 FOR PRECAST SLAB
 ISOMETRIC, TYP DETAIL, AND NOTE.

Fig. 5. Connection detail of precast floor slab and interior wall, detail 2.

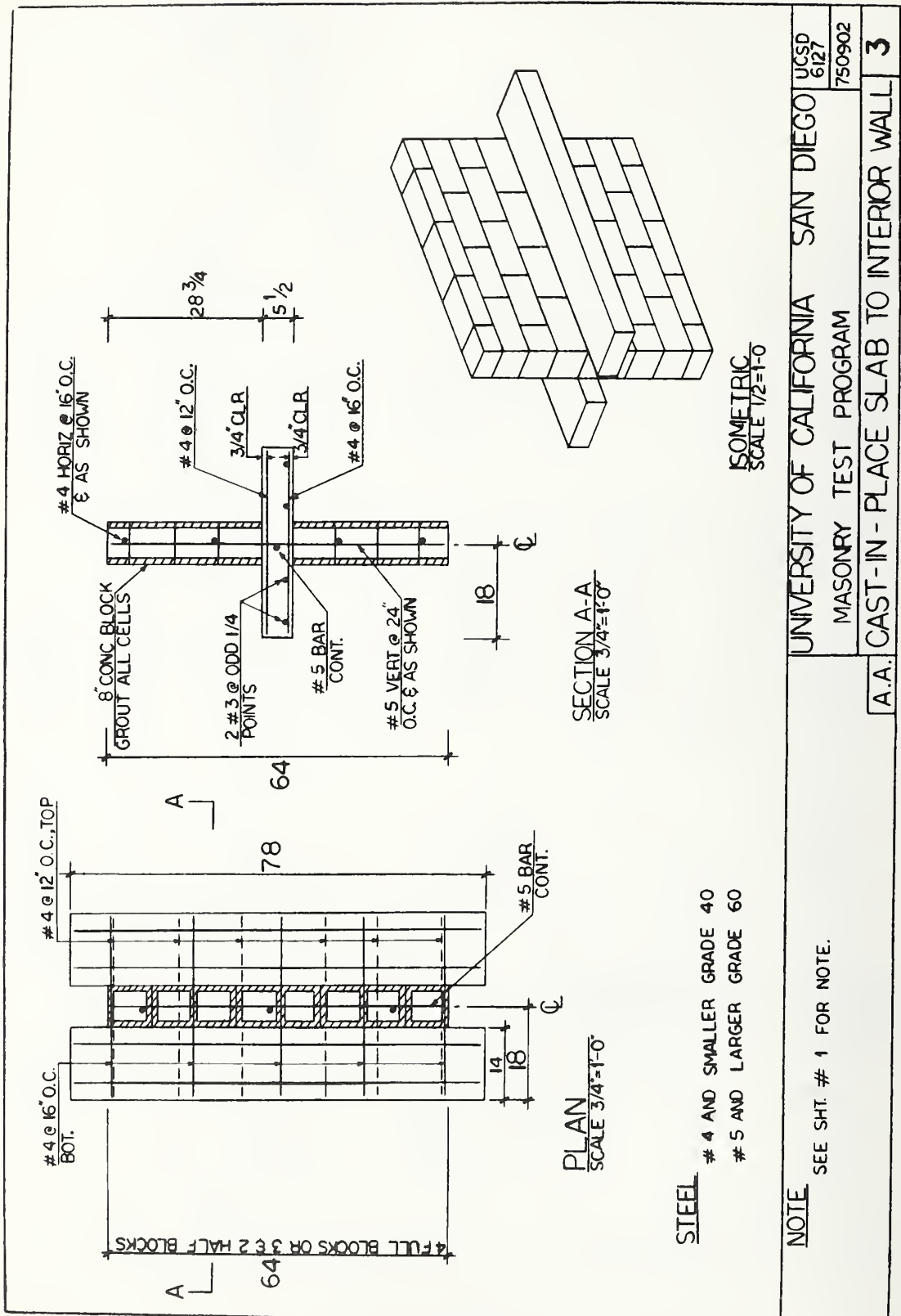

Fig. 6. Connection detail of cast-in-place floor slab and interior wall, detail 3.

MASONRY RESEARCH AND CODES IN THE UNITED KINGDOM

William B. Cranston
Deputy Head, Design Department
British Cement and Concrete Association

ABSTRACT

A brief description of the various research projects known to the author is given, defining the objectives, conclusions and tentative conclusions where appropriate. Selected references are also given. The second part of the paper gives details of some of the proposed changes and additions to the United Kingdom Masonry Code.

INTRODUCTION

Much of the current research in the United Kingdom is fundamental in character, and there are no projects directly related to response to earthquake loading. However, precisely because the work is fundamental it should have as much application to earthquake loading as to any other loading. The work is mainly on unreinforced masonry, reflecting the currently small use of reinforced masonry in the U.K.

The work is summarized for each establishment in turn, and the names of the individuals concerned are also given. Further information on the projects can be obtained by contacting the organisations direct.

As far as Codes are concerned, the current version was written originally in 1948 and has been subject to only minor amendment since that time. A revised draft, introducing the limit state concept, is nearing completion. The limit state format would seem particularly useful to the treatment of earthquake, since specific methods are given to define the ultimate resistance of masonry. It is hoped therefore that this information will prove useful to the workshop.

1. RESEARCH PROJECTS

1.1 Cement and Concrete Association, Wexham Springs, Slough SL3 6PL United Kingdom

Staff - W.B. Cranston, J.B. Read, J.J. Roberts, S.W. Clements

Project 1 Vertical load capacity of concrete block masonry under central and eccentric load.

Reports of tests under central load have been published⁽¹⁾⁽²⁾ and a paper containing details of the first series of eccentrically loaded walls has also been published⁽³⁾. A major feature of this work has been that strain and deflection readings have been recorded on the walls up to the point of maximum load and beyond in some cases (a stiff 800 T capacity testing machine is being used). An interesting result is that slender eccentrically loaded walls reach maximum load without any material distress being evident in either blocks or mortar. Also strains measured across the joints are very much larger than those calculated allowing for the reduced E appropriate

to the mortar. This phenomenon was also noted by and perplexed early American investigators (4). It has been tentatively concluded on this that even with the best workmanship there are substantial areas of the bed joints where there is a slight crack or separation up to 0.1mm (0.004") wide, due in part to mortar falling away at the edges of the joint. This is the so-called "teeter-totter" effect described by Haller (5). An even earlier reference is made by Nylander (6) who refers to a thesis by Hast (7).

Further test work on eccentrically loaded walls is planned and tests with extensive strain measurements in the joint area are being made on prisms made from two stack-bonded blocks.

Project 2 The effect of perforations in brick shaped units

Tests on solid bricks give an overestimate of the uniaxial strength, due to confinement stresses induced by the testing machine platens. Obviously perforations must reduce this confinement effect and the strength indicated from testing the perforated brick should be closer to that exhibited in wall tests, where the platen effect does not exist.

In the tests perforations have been introduced into 215 x 105 x 65 mm concrete bricks by carefully drilling holes of various diameters, to give perforated areas ranging from 2.7% to 7%. Standard unit tests were carried out with plywood sheets between the brick faces and the testing machine platens and a 20% reduction in unit strength expressed over gross area was recorded at the 7% perforation level. Five-high prisms using a mortar with strength close to that of the bricks showed a reduction much nearer to the 7% net area.

It thus appears that the ratio of unit strength to masonry strength is higher for perforated units, and this could lead to changes in the design stresses.

Project 3 Influence of capping material on indicated unit strength of concrete blocks.

A large series of tests (8)(9) have been carried out with mortar capping and various types of board capping. It has been concluded that the board capped blocks give an indicated strength consistently 10% less than the mortar capped blocks, with a similar coefficient of variation. It follows that the fibre board method will be equally effective in providing a production of site controls of block strengths. The costs of a board capped test are considerably less than for mortar capping and it is hoped that this method will be adopted in U.K. practice.

Project 4 Behaviour of reinforced block masonry walls in flexure.

Approximately 35 specimens with various reinforcement arrangements have been tested. Standard size reinforcing bars were used and in-situ concrete cast around the bars previously placed in voids in hollow blockwork. High slump concrete was used to ensure proper filling of all voids. The essential conclusion from the tests is that the ultimate behaviour is, as far as can be seen, identical to that displayed by ordinary reinforced concrete. The ultimate moments can be predicted from conventional assumptions in regard to ultimate strains and stress-blocks. No reinforcement was provided to resist shear forces, and apart from a few specimens with impractically large percentages of steel, no shear failures occurred. Further work is planned to evaluate flexural failure more precisely and to check on behaviour in shear.

Project 5 Ductility of concrete compression zone.

This project is currently studying the effects of the aspect ratio, i.e. ratio of breadth of compression zone to depth of neutral axis, of the compression zone in beams on the rotation capacity. Up till recently it has been thought that the major variable was just the depth to the neutral axis. Where the breadth is large in respect to the depth, i.e. in a slab situation, rotations of 0.05 to 0.10 radians are easily attainable, without the compression zone losing its capacity to resist load. Where the breadth is small in respect to the depth, the rotation capacity is much less. Provided, however, the neutral axis depth is kept below 0.3 of the effective depth, reasonable rotations (up to .02 - .03 rad) are still obtained.

It is expected that these results will also be valid for masonry shear walls, subject to bending, provided the shear capacity of the wall is not exhausted first. It is intended to carry out some shear wall tests to confirm this.

1.2 Department of Civil and Structural Engineering, Polytechnic of the South Bank, Wandsworth Road, London SW8 2JZ, United Kingdom

Staff - Mr. Colin Anderson

Project 1 Lateral resistance of concrete block masonry wall panels

A major design problem has arisen in the U.K. in that large unreinforced wall panels have been installed in many single storey industrial buildings without, it appears, any great number of failures. New Building Regulations now clearly do not permit such large size panels and there is no authoritative design guidance available. The typical slenderness ratios for the panels used are often well outside the limits of the current German or American Codes.

Around 20 walls (10), (11) have been tested so far under various boundary conditions and this indicates that a yield line type of failure takes place, accompanied by membrane forces. The development of these membrane forces means that the wall still carries load at deflections up to and beyond half the wall thickness, at which stage an extensive pattern of cracking has developed. Most panels tested have been supported on two sides and base and lateral resistances of between 100 - 200 lb/sq ft have been developed. Panels supported top and bottom are giving much lower results, as would be expected, in the 10 lb/sq ft region.

Further work in this area will depend on continued funding, which is at present mainly from Government sources.

Project 2 Direct tensile strength of mortar - block interface

A series of tests, using the standard apparatus as specified for the ASTM test have just begun, following an extensive series of flexural tests on four-high stack-bonded prisms. Strains measured across the joints in such tests indicate a much higher joint strain than can be calculated allowing for the reduced E appropriate to the mortar. This is in accord with the Cement and Concrete Association's results under compressive loading.

1.3 British Ceramic Research Association, Queens Road, Penkhull,
Stoke-on-Trent ST4 7LQ, United Kingdom

Staff - H.W.H. West, H.R. Hodgkinson, D.C. Beech, B.A. Haseltine*

Project 1 Lateral resistance of brick masonry wall panels - with
vertical precompression

This work is of many years standing and was designed to establish levels of precompression which would enable walls to withstand the 5 p.s.i. (720 lbs/sq ft) 'accidental pressure' which has been specified in U.K. Codes following the Ronan Point collapse. As a result a simple three pinned arch theory has been accepted in the revision to the Masonry Code from which the precompression required on the wall of a given storey height and thickness can be derived. Typical calculations show that the normal dead load and live loads from four, or even three, storeys is sufficient to provide this precompression. It follows that in many cases no special design features are needed to deal with this problem at the lower storey levels, apart from adequate ties to external walls.

Project 2 Lateral resistance of brick masonry walls - without precompression

This project exists for the same reasons as that outlined under the similar heading for concrete masonry walls and is somewhat more advanced in that a wider range of tests have been carried out. Three technical notes (12), (13), (14) have been published giving results and recommendations. Yield line theory is suggested as the basis for design using different moments of resistance across and at right angles to bed joints. These moments of resistance are to be calculated from recommended tensile stresses which vary according to the absorption characteristics of the bricks.

Testing is continuing with some tests being carried out using virtually rigid side supports.

Project 3 Use of probability theory to determine safety factors

This work was carried out to assist in establishing safety factors to cover various degrees of control in manufacturing units and varying standards of workmanship on sites. Considerable anomalies emerge from using normal, i.e. Gaussian, distributions and these have been overcome by using normal distributions truncated beyond three standard deviations. A technical note (15) is available.

1.4 Department of Civil Engineering and Building Science, Edinburgh
University, King's Buildings, Mayfield Road, Edinburgh EH9 3JL,
Scotland, United Kingdom.

Staff - A.W. Hendry, B.P. Sinha

Project 1 Shear resistance of unreinforced masonry

This project is complete and the results published some considerable

*Consultant to British Ceramic Research Association

time ago (16). It forms the basis for the proposals in the revised U.K. Code which define characteristic shear strength equal to a small basic strength, essentially equal to the shear strength along bed joints in the absence of precompression, plus $0.4 g_d$ where g_d is the average stress produced by precompression.

Project 2 Estimation of effective length and design eccentricity

Present assessments of effective length as affected by the restraints provided by slabs are extremely arbitrary, as are the assumptions about eccentricity of load applied by the same slabs. The provisions whereby effective height is determined by the width of panels between stiffening piers or return walls are also arbitrary.

Full scale testing is currently being planned to investigate this general area.

Project 3 Lateral loading of masonry panels

This is similar to the projects under way at the Polytechnic of the South Bank and at the British Ceramic Research Association. In this instance the work has been carried out on walls constructed of model bricks. Broadly the same conclusions have been reached (17) as in the other establishments, but there is some disagreement as to appropriate tensile stresses for design. Tests on full size brick prisms have been carried out (18) to investigate this point.

Project 4 Concentrated loads on masonry walls

The current U.K. Code allows an arbitrary 50% increase in design stress for concentrated loading. A series of tests have been carried out to check whether this increase is justified. The conclusion is that it is, but some caution is suggested for loads applied at the end of a wall, and some increase in stress might be admissible where the load is some distance from the end.

1.5 University of Wales, Institute of Science and Technology,
Cathays Park, Cardiff, Wales, United Kingdom

Staff - A. Lenczner

Project 1 Creep in concrete and brick masonry

With high rise construction the possibility of large movements due to creep of concrete block work clearly requires assessment. This project has been operative for a number of years and results have been published (19)

1.6 Building Research Establishment, Garston, Watford WD2 7JR,
United Kingdom

Staff - J. Moore

Project 1 Reinforced brick masonry

An extensive series of tests on reinforced walls and columns has been carried out, with reinforcement placed mainly in grouted cavities. This work was carried out some years ago for the British Ceramic Research Association and has not yet been published.

Project 2 Lateral load on wall panels

No work on this is being carried out at the Building Research Establishment, which in this instance is supervising work being carried out by the British Ceramic Research Association.

1.7 Department of Civil Engineering, Paisley College of Technology, High Street, Paisley PA1 2BE, Scotland, United Kingdom

Staff - G. Keay

Project 1 Properties of masonry made from aerated concrete blocks

Aerated (or foam) concrete blocks are extensively used in the U.K. because of their insulation properties. Their mode of failure appears in some respects more brittle than that of concrete blocks, and in other respects (e.g. fixings can be simply screwed in) more plastic. Some preliminary testing on a project to investigate the properties has been done, but is in abeyance since the member of staff concerned is currently on a sabbatical year in Australia.

2. MASONRY CODES IN THE UNITED KINGDOM

2.1 Introductory remarks

Current recommendations for design in the U.K. are contained in a Code of Practice CP 111 - 1970⁽²⁰⁾. The latest revision was in 1970, but most of its content is very much the same as when it was originally drafted in 1948. For this reason this paper will deal with the revised version which is currently being considered. It is impossible to deal with the draft in full and for this reason a number of the salient features have been selected for presentation. Despite the fact that no drafts for reinforced masonry have been prepared some anticipatory remarks are made on that subject.

2.2 Limit state concepts

The limit state concept, as agreed by the CEB (Comite Europeen du Beton), has been adopted in the United Kingdom and several other European countries as the basis for reinforced and prestressed concrete design. Essentially, attention is focussed on the various ways in which the structure may become unfit for use, each of these ways being called a limit state. Limit states are divided into two broad categories, ultimate or collapse limit states, and serviceability limit states. A structure which has attained an ultimate limit state would require either total or partial replacement. A structure which has attained a serviceability limit state will require remedial repairs but no substantial replacement. For reinforced concrete the most important serviceability limit states are those due to excessive cracking or deflexion. Such limit states do not generally apply to masonry and this leaves the principle limit state in masonry as being the ultimate or collapse limit state.

The existing masonry Code is based on permissible stresses, from which it might be inferred that a serviceability design is being suggested, i.e. the stresses might have been chosen to keep cracking and vertical shortening under load to suitable levels under working load. However, reference to the technical papers on which the Code is based shows that the stresses were obtained by dividing ultimate stresses obtained from tests to collapse by an appropriate safety factor. However the magnitude of this figure has never really been pinned down. A figure above 4.5 is seldom suggested, 3.5 is about the lowest that is agreed as acceptable. The key point is that the procedure is already an application of the limit state concept, by providing a large single safety factor of safety against collapse conditions being reached.

In developing the application of the limit state concept further it is necessary to consider in detail the possible individual influences which could lead to a collapse. Some of these are:-

- (a) Possible increase in loads.
- (b) Possible understrength of units.
- (c) Possible understrength of mortar.
- (d) Inadequate filling of joints.
- (e) Errors in specified stresses in Codes (may be unconservative for unit type or bond being used).
- (f) Errors due to simplification in analysis (e.g. neglecting eccentricity of load).

These influences are not too difficult to assess and it is also not difficult to assign reasonable figures for their possible variations. It is as well to point out here that most actual collapses occur due to gross errors, such as using an office as a paper store, delivering wrong (and much weaker strength) units to site, misreading the permissible stress from the tables in the Code, or failing to appreciate that the layout of a building does not provide lateral support at the top of the walls. The prevention of gross errors, whether in use, construction or design, cannot be by safety factors but by proper controls, inspection and checking.

It is tempting to try to take account separately of each individual influence and assign different safety factors to each one. The ISO Recommendations on this (21) list a total of six partial safety factors. A more pragmatic approach has been adopted in the U.K. draft in that progress has gone from 1 safety factor on stresses or material strengths to 2 partial safety factors, one on loads and the other on material strengths. The partial safety factors γ_f on loads are 1.6 on imposed load and 1.4 on dead load, and the structure is analysed under these factored loads. This has the result of giving somewhat higher calculated values for eccentricity. The partial safety factor γ_m on materials is not finally settled but is likely to vary between 2.5 and 3.5 depending on the control exercised on the unit strength and site workmanship. The design process ensures that the walls are capable of carrying the loads arising from 1.4D and 1.6D on the assumption that the masonry strength is $1/\gamma_m$ times a so-called characteristic strength which will be specified in the construction documents. For slender walls an additional eccentricity corresponding to ultimate conditions is defined and the resistance of the critical cross-section is calculated using a simple rectangular stress block. Under

central load the maximum stress in the block is taken as f_k/γ_m where f_k is the characteristic masonry strength. Under eccentric load at right angles to the wall the maximum stress in the stress block is taken as $1.1 f_k/\gamma_m$. Under eccentric load in the plane of the wall, i.e. when shear wall action is being considered, the stress distribution at ultimate is taken as triangular with a maximum equal to f_k/γ_m .

The assumption of a rectangular stress block is simple to apply where solid fully bedded units are being used but is more difficult with hollow or perforated units. However, all practical hollow or perforated units have a cross-section with material concentrated at the outer faces and are more efficient at resisting eccentric load. Thus it will be on the safe side to use factors derived for solid blocks.

The parameters assumed to control the masonry strength are the unit strength and the mortar grade. Site control tests are limited to tests of these. A characteristic strength may be derived from storey height wall tests - but not from prism tests.

The above represents an undeniably crude procedure for predicting the behaviour and strength of walls under ultimate conditions, and points to a clear need for more research into the detailed behaviour of walls at collapse.

2.3 Proposals to deal with lateral loading on wall panels

A popular type of design in the United Kingdom for single storey construction is where widely spaced concrete or steel portal frames carry the roof load and the walls are purely infill panels between columns. Current design calculates bending moments under 50 year return period wind loads and checks against a bending strength based on a very low tensile strength. Testing to establish the ultimate strengths of such panels indicates a considerable reserve of strength beyond the initial cracking stage and it seems that a yield line type of analysis, similar to that used for reinforced concrete slabs, is admissible. Design procedures based on this have been worked out, although discussion continues on how to assess an appropriate ultimate strength along the yield lines. One of the major advantages of the method is that the yield line theory can easily be applied to cases where window and door openings are present, cases where elastic analysis becomes very difficult indeed.

The panels of such construction tend to be much more slender than North American practice, particularly since cavity construction is used with inner and outer leaves. While cavity construction in Britain is designed to resist water penetration from driving rain, this is now possibly less of a problem than was initially thought. However insulation requirements have been made much more stringent and are likely to provide an even greater use of cavity construction.

2.4 Proposals to deal with accidental damage

Specific requirements are laid down for structures of five or more storeys although there is a general requirement for all structures to be 'robust'. This implies arrangements of walls to resist shear in two

directions and connections of floors to and through walls, such that an overall diaphragm action of the floor is possible.

The specific requirements are either for minimum vertical, transverse and peripheral ties to be provided throughout the building. The reasoning behind this is similar to that described by Fintel and Schultz (22) for panel buildings. Vertical ties may be omitted if the vertical members concerned can carry a lateral pressure of 5 p.s.i. In checking against this the preload or prestress effect of dead and live load from storeys above can be taken into account. The practical result of this is that walls carrying four or more storeys generally will not need vertical ties.

Another specific requirement is to require all structures to be able to resist under ultimate conditions a lateral load equal to $1\frac{1}{2}\%$ of the dead load of the building. In many cases in the United Kingdom the design wind loads are small and this $1\frac{1}{2}\%$ requirement is going to govern many designs. Currently there is a suggestion to bring the percentage down to 1%. It is difficult to compare Codes precisely but it would seem that this effectively 0.015 D ultimate requirement would translate to around an 0.005 D requirement in the permissible stress situation used in current North American Codes. This would, again very roughly, seem to be adequate for minor earthquake loading. So it appears that the U.K. will be prepared to some extent for possible earthquakes, even though no earthquakes causing other than absolutely minimal structural damage have occurred in the U.K. for the last 100 years.

2.5 Reinforced masonry

It is proposed to consider drafts in this area as soon as the Code for unreinforced masonry is finalised. Reinforced masonry in the U.K. has been used only for some rather specialist applications. It is likely that the provisions will be in ultimate limit state terms, with definitions for an ultimate stress block being laid down.

A particular difficulty will arise out of the U.K. reluctance to use the prism test, which is the only reliable way in which an estimate of the infill mortar or grout strength can be made.

As far as reinforced concrete block masonry is concerned where vertical and horizontal reinforcement is used the behaviour is likely to be very close to that of a reinforced concrete wall, particularly where the infill mortar grout surrounds the horizontal reinforcement in bond beams. For this reason the design clauses will probably be very much based on the provisions for reinforced concrete walls given in the current U.K. reinforced concrete Code CP 110 (23).

3. CONCLUDING REMARKS

It will be seen that there is a considerable U.K. effort being directed to research and revision of design standards in masonry. This reflects from a steady usage of masonry in construction. The work described relates only to response under loads. It should be emphasised that a considerable additional research effort is being devoted to other areas, such as sound insulation, noise insulation, rain penetration and fire resistance.

REFERENCES

1. Read, J.B. and Clements, S.W., The Strength of Concrete Block Walls, Phase I: Construction and Proving of a Suitable Test Frame: Cement and Concrete Association, Technical Report 42.461, London, 1971.
2. Read, J.B. and Clements, S.W., The Strength of Concrete Block Walls, Phase II: Under Uniaxial Loading: Cement and Concrete Association, Technical Report 42.473, London, 1972.
3. Cranston, W.B. and Roberts, J.J., The Structural Behaviour of Concrete Masonry - Reinforced and Unreinforced: The Structural Engineer, Vol. 54, No. 11, November 1976, p. 423.
4. Richart, F.E., Woodworth, P.M., and Moorman, R.B., Tests of the Stability of Concrete Masonry Walls: Proceedings of the American Society for Testing and Materials, Vol. 31, 1931, p. 661.
5. Haller, P., The Technological Properties of Brick Masonry in High Buildings: Translation, No. NRC TT-792, 1959, National Research Council of Canada.
6. Nylander, H., Investigation of the Strength of Concrete Block Walls, Betong, 1944.
7. Hast, N., Measuring Stress and Deformations in Solid Materials: Royal Swedish Institute for Engineering Research, Proceedings No. 178, Stockholm, 1945.
8. Roberts, J.J., Specification for a Machine for Testing Concrete Blocks in Compression: Cement and Concrete Association, Technical Report No. 42.499, London, 1974.
9. Roberts, J.J., The Effect of Different Test Procedures Upon the Indicated Strength of Concrete Blocks in Compression: Magazine of Concrete Research, Vol. 25, No. 83, June 1973, pp. 87-98.
10. Anderson, C., Lateral Loading Tests on Concrete Block Walls: The Structural Engineer, Vol. 54, No. 7, July 1976.
11. Anderson, C., and Bright, N.J., Behaviour of Non-Loadbearing Block Walls Under Wind Loading: Concrete, September 1976.
12. Hodgkinson, H.R., Haseltine, B.A., and West, H.W.H., Design of Laterally Loaded Wall Panels: Part I: British Ceramic Research Association, Technical Note No. 242, 1975.
13. West, H.W.H., The Flexural Strength of Clay Masonry Determined from Waffle Specimens: Proceedings Fourth International Brick Masonry Conference Bruges, April 1976.
14. Haseltine, B.A., and West, H.W.H., Design of Laterally Loaded Wall Panels: Part 2: British Ceramic Research Association, Technical Note No. 248, 1976.
15. Beech, D.C., Some Problems in the Statistical Calculation of Safety Factors: British Ceramic Research Association, Technical Note No. 244, 1975.
16. Sinha, B.P., and Hendry, A.W., Racking Tests on Storey-Height Shear-Wall Structures with Openings, Subjected to Precompression: Gulf Publishing Company, Houston 1969.

17. Hendry, A.W., The Lateral Strength of Unreinforced Brickwork: The Structural Engineer, Vol. 51, No. 2, February 1973.
18. Satti, K.M.H., and Hendry, A.W., The Modulus of Rupture of Brickwork: Proceedings 3rd International Masonry Conference, Essen, 1973.
19. Lenczsner, D., Creep and Moisture Movements in Brickwork and Blockwork: International Conference on Performance of Building Structures, Glasgow University, 1976.
20. CP111 - Structural Recommendations for Loadbearing Walls, British Standards Institution, London, 1970.
21. General Principles for the Safety of Structures: ISO 2394, 1973.
22. Fintel, M., and Schultz, D.M., A Philosophy for Structural Integrity of Large Panel Buildings: Jour. of the Prestressed Concrete Institute, Vol. 21, No. 3, 1976.
23. CP110 - The Structural Use of Concrete - Pt. 1: British Standards Institution, London 1972.

THE CAPACITY OF
UNREINFORCED MASONRY SHEAR WALLS
UNDER MEMBRANE LOADS

S.G. Fattal*

National Bureau of Standards

ABSTRACT

Four different types of unreinforced masonry walls and miscellaneous companion prisms were subjected to various configurations of membrane forces to study shear wall limit states in both clay brick and concrete masonry. The specimens that were subjected to diagonal compression, in combination with edge loads applied normal to the bed joint, generally displayed failure modes characterized by diagonal splitting through the masonry units or by separation along the mortar joints. The test results exhibited a dependence between diagonal load capacity and the intensity of normal loads. Square specimens of dissimilar size but similar in composition developed comparable strength when subjected to diagonal loading alone, providing an experimental basis for evaluating the diagonal compressive strength of masonry by standard tests using small prisms. The directional variation of strength was investigated by means of diametral compression tests of circular walls and diagonal compression tests of rectangular prisms having different aspect ratios.

Key Words: Brick; clay masonry; concrete block; concrete masonry; failure modes; load capacity; masonry walls; shear walls; splitting strength; ultimate capacity.

*Structural Research Engineer, Center for Building Technology, IAT

1. SCOPE

Four types of masonry construction were investigated in this project. They were nominally 4-in (100-mm) (thick) single wythe brick (clay masonry), 10-in (250-mm) double wythe grouted brick, 8-in (200-mm) hollow concrete block and 8-in (200-mm) fully grouted concrete block. The nominal sizes of the specimens and the manner of loading are specified in Figure 1. Square specimens of three dissimilar sizes were tested in diagonal compression to acquire an experimental basis for a possible reduction in the size of the 4-ft (1.22-m) square specimen currently recommended by the ASTM E519 [1] diagonal tension test method for masonry assemblages. The 4-ft (1.22-m) square specimens, in addition, were tested in diagonal compression after having been subjected to precompressive forces of different magnitudes, applied normal to bed joint. The intent of these tests was to examine the validity of recently-proposed failure hypotheses [2, 3] to predict the strength of the diverse types of masonry used in the present test series. The diagonal compression tests of the rectangular specimens with aspect (height-to-length) ratios of 2.0 and 0.5, and the diametral compression tests of circular grouted concrete block specimens were utilized to study the directional variation of splitting strength relative to the orientation of bed joint. For each type of construction, companion prisms of similar composition were constructed and tested in compression in accordance with the ASTM E447 [4] test method.

2. CONSTITUENTS AND TEST SPECIMENS

The materials selected for the construction of the test specimens were commercially available and, in general, were typical of those commonly used in building construction.

The brick units were solid with three circular cores (Fig. 2c), conforming to Grade SW, Type FBS, as specified in ASTM C216 [5], and measuring 3.55 x 2.25 x 7.62 in (90.2 x 57.2 x 194.0 mm) actual. When tested in accordance with ASTM C67 [6], the average physical properties for 5 replicates each, were: compressive strength = 9793 psi (67520 kN/m²); modulus of rupture = 1010 psi (6963 kN/m²); initial rate of absorption = 5.6 g/30 in²/min (0.093 g/19000 mm²/s); 24-hour cold absorption = 6.5%; 5-hour boil absorption = 8.1%; saturation coefficient = 0.79.

The concrete masonry units were 8 x 8 x 16 in (200 x 200 x 410-mm) nominal, 7.6 x 7.6 x 15.5 in (193 x 193 x 394 mm) actual, two-core hollow normal weight block. All units were of the same shape, known as kerf block (Fig. 4a), which has a double center web spaced approximately 1/4 in (6.4 mm) apart, which allows cutting into half units for courses requiring such at the end of the specimen. Two strengths of kerf units were supplied. The higher strength units were used in the construction of the circular specimens, the lower strength units were used in the construction of all the other concrete block specimens.

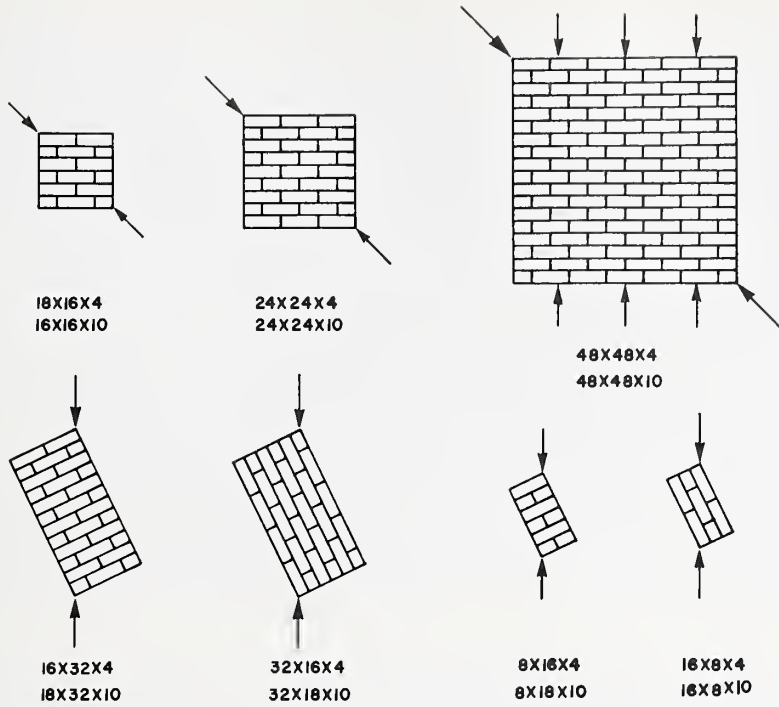

BRICK MASONRY TESTS

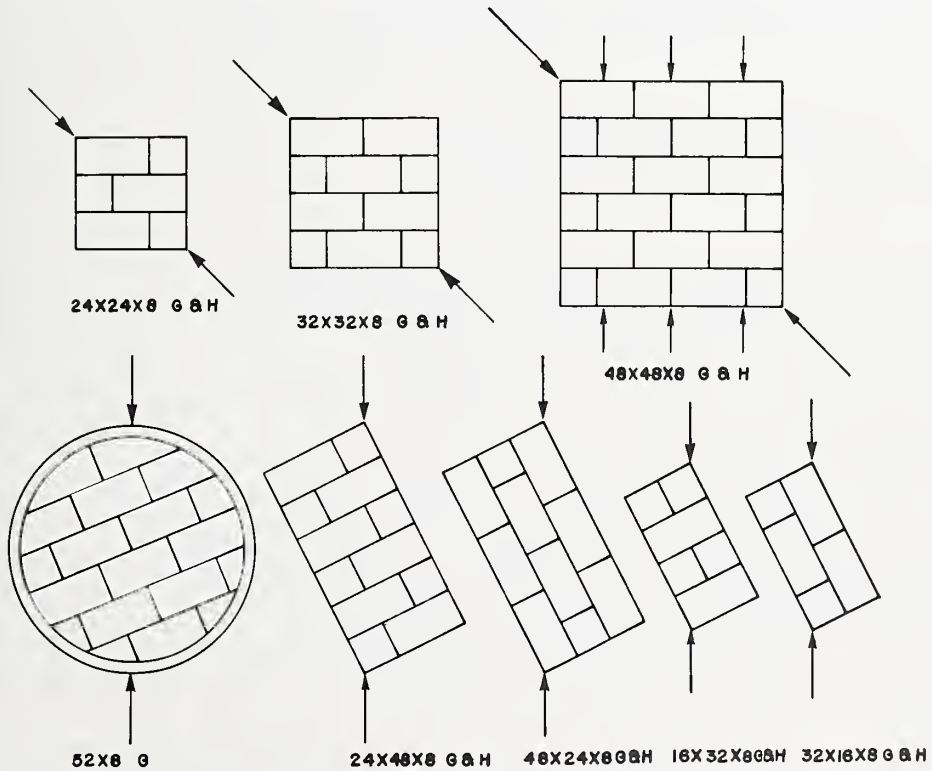

CONCRETE BLOCK MASONRY TESTS

Figure 1 Configuration of test specimens and loading

The physical properties of the concrete masonry units from 5 replicate tests conforming to ASTM C140 [7] were, for the higher strength units: compressive strength, gross area = 2520 psi (17390 kN/m²); compressive strength, net area = 4480 psi (30910 kN/m²); absorption = 11.2 pcf (179 kg/m³); unit weight = 119.9 pcf (1921 kg/m³); net area = 56.2% of gross area. The corresponding figures for the lower strength units were: 2100 psi (14490 kN/m²), 3700 psi (25530 kN/m²), 11.3 pcf (181 k/m³), 118.4 pcf (1897 k/m³), and 56.8%, respectively.

The mortar used in all the specimens was Type S conforming to ASTM C270 [8]. Type I portland cement, Type S hydrated lime and masonry sand with a fineness modulus of 2.10, established by sieve analysis in accordance with ASTM C144 [9], were proportioned 1:1/2:4 1/2 parts by volume, the actual measurement of constituents used in each batch of mortar being made by weight as follows: cement, 25.0 lb (11.3 kg); lime, 5.3 lb (2.4 kg); masonry sand, 85.7 lb (38.9 kg); water, 22.0 lb (10.0 kg). Mortar flow according to ASTM C109 [10] averaged 111%, and 94% after suction, indicating a water retention of 85%. The 28-day average compressive strength of 2-in (51-mm) mortar cubes, cured under similar conditions as the test specimens, was 1704 psi (11760 kN/m²), with a coefficient of variation of 0.17.

The grout used was proportioned in accordance with ASTM C476 [11] Coarse specifications using sand with a 3.1 average fineness modulus and pea gravel with a 5.7 fineness modulus. The proportions by weight were: masonry sand, 58.5 lb (26.5 kg); pea gravel, 46.7 lb (21.2 kg); portland cement type I, 25.0 lb (11.3 kg); type S hydrated lime, 1.1 lb (0.5 kg); water, as required for workability. The 28-day average compressive strength of grout and coefficient of variation were, respectively: 3181 psi (21950 kN/m²) and 0.08 for 2-in (51-mm) cubes; 2896 psi (19980 kN/m²) and 0.23 for 3 x 3 x 6 in (76 x 76 x 152 mm) prisms (UBC 24-23) [12]; and 1990 psi (13730 kN/m²) and 0.23 for 6 x 12 in (152 x 305 mm) cylinders (ASTM C39) [13].

All test specimens were constructed by experienced masons and were air-cured at approximately 70F (21C) temperature and 50 percent relative humidity. Grouting of the specimens occurred from 7 to 15 days after construction of the masonry. In the 10-in (254-mm) grouted brick specimens, 3/16-in (5-mm) dia. Z-shaped wire ties were placed uniformly at the rate of approximately one tie per 200 in² (1290 cm²) of wall surface area. The circular specimens required special cutting and bracing. The corner units were precut before construction (Fig. 6f). After grouting, the specimens were laid horizontally and strapped with an 1/8-in (3-mm) thick steel band. Two single strands of joint reinforcement were placed in the cores of adjoining cut blocks at the four corners and a 1:3 cement sand grout was cast between the band and the specimen to form a circular wall 52 in (1320 mm) in actual diameter. Running bond construction was used throughout except the concrete block compression prisms were in stacked bond.

3. DESCRIPTION OF TESTS

To the extent possible, the diagonal compression tests were conducted in accordance with the ASTM E519 [1] testing procedure. This included capping of all bearing surfaces with high-strength gypsum and use of steel loading shoes with the following exceptions. The loading shoes of the concrete block specimens other than the 4-ft (1.22-m) square and 52-in (1321-mm) circular walls were cast gypsum. This was achieved by seating the bearing corners of the specimen in a bed of high-strength gypsum placed within a wood formwork which was removed after setting. In all cases, the length of the bearing shoe was approximately 1/6 the side dimension of the specimen. Although this dimension was somewhat larger than the 1/8th side dimension recommended by ASTM E519, it was deemed necessary to prevent premature crushing failure at the diagonally loaded corners. The configuration of the steel loading shoes is shown in Figure 2. The loading shoes of the circular specimens were prepared by seating the wall in a 1.5-in (38-mm) thick mortar bed within a shallow steel frame with 9 x 12 in (229 x 305 mm) inside dimensions (Fig. 6).

The end fixtures for the 4-ft (1.22-m) square walls that were subjected to edge loads prior to the diagonal compression, consisted of stiffened W8 x 31 steel beams bolted and welded to the corner shoes (Fig. 3). They were seated in gypsum applied to the bearing surfaces of the walls. The edge loads were applied by three hydraulic jacks bearing against a reaction frame mounted on the wall. The assembly was tested in diagonal compression in a universal testing machine as shown in Fig. 3(d).

The instrumentation for the 4-ft (1.22-m) square walls tested in diagonal compression with no edge loads consisted of linear variable differential transformers (LVDT's) with gages spanning between the centers of diagonally opposite corner units in both directions (Figs. 2, 4a, 5a) as well as diagonal gages between centers of adjacent units at the center of the specimens. Some of these specimens were instrumented, in addition, with LVDT's mounted peripherally as in Fig. 2e. Dial type diagonal deformation gages were used in some of the tests of smaller brick specimens (Fig. 2a).

The instrumentation for the 4-ft (1.22-m) square walls tested with edge loads and diagonal compression consisted of 8 LVDT's mounted on opposite faces and near the center of the wall. The gages were modular in length (i.e., spanning between centers of adjacent units), each opposite pair being oriented in one of four specified directions: parallel and normal to bed joint and along each diagonal. An additional gage mounted vertically was used to monitor the movement of the loading head relative to the base.

The circular walls were instrumented with four deformation gages of modular length near the center and at opposite faces, mounted horizontally and vertically (Fig. 6). The specimens tested with the bed joints in vertical alignment were instrumented with four additional gages as shown in Fig. 6e.

Digitized data output from each gage consisted of load-deformation measurements taken at 15-sec intervals throughout the loading range. The rate of loading was typically 20- kip/min (89 kN/min). In each test, the signal from at least one gage at the center of the wall across the loaded diagonal, together with that of the load transducer, were monitored on an x-y recorder which provided continuous load-displacement plots and helped identify the failure load at which initial splitting occurred.

4. TEST RESULTS

The test results are summarized in Tables 1 through 5. To conserve space, only the mean strength values are tabulated, together with the corresponding coefficient of variation in cases where there were more than two replicate tests. The actual and nominal sizes of the noncircular specimens are specified in terms of length L , parallel to bed joint, height h , normal to bed joint, and thickness t , in that order. The size of the circular walls is specified in Table 5 in terms of diameter D and thickness t .

In Table 1, the results of diagonal compression tests of the square specimens are expressed in terms of a nominal shear strength $\bar{\tau}'_d$, which is equal to the component of the diagonal failure load P'_d , parallel to bed joint, divided by the actual cross sectional area (gross or net). The test results of the rectangular specimens are presented in a similar manner in Table 2 where $\bar{\tau}'$ designates the nominal shear strength.

The results of square wall tests under edge loads and diagonal compression are shown in Table 3, where the nominal shear stress $\bar{\tau}'$ designates the component of the diagonal failure load P' parallel to bed joint divided by the specified area, and the nominal vertical stress $\bar{\sigma}'_y$ denotes the sum of edge load P'_v and the component of load P' normal to bed joint divided by the same area. All these specimens were tested after 9 months from the date of fabrication.

Table 4 gives the compressive strength f'_m for the four types of masonry prisms tested in accordance with ASTM E447 [4]. Two different sizes of brick prisms were tested to examine the influence of the h/t ratio on compressive strength. The entries in the last column represent compressive strength values modified by h/t -related correction factors recommended by the current masonry standards [14, 15].

The results of circular wall tests are shown in Table 5. Angle θ designates bed joint inclination with respect to horizontal and P' designates the vertical compressive load at failure. The entries in the last two rows represent the tensile splitting strength f'_s estimated from the well-known solution $f'_s = 2P'/\pi Dt$ based on isotropic, linear, elastic behavior [16].

TABLE 1. - Results of Diagonal Compression Tests of Square Specimens

Type of Masonry	Number of Specimens	Nominal (Actual) Size L x h x t (in x in x in)	Gross (Net) Area A (in ²)	Age (Age of Grout) (days)	$\bar{\tau}'_d$ (psi)	Coefficient of Variation
Single Wythe Brick	3	16 x 16 x 4 (15.7 x 15.7 x 3.55)	55.7	29	509.9	0.063
	5	24 x 24 x 4 (24.0 x 23.7 x 3.55)	85.2	29	316.2	0.106
	2	48 x 48 x 4 (47.7 x 47.7 x 3.55)	169.3	35	299.3	-----
Double Wythe Grouted Brick	5	16 x 16 x 10 (15.7 x 15.7 x 10.0)	157.0	42 (28)	663.0	0.187
	5	24 x 24 x 10 (24.0 x 23.7 x 10.0)	240.0	40 (28)	425.4	0.089
	2	48 x 48 x 10 (47.7 x 47.7 x 10.0)	477.0	54 (40)	371.5	-----
Hollow Concrete Block	5	24 x 24 x 8 (23.8 x 23.8 x 7.6)	180.9 (102.7)	44	158.6	0.131
	2	32 x 32 x 8 (31.8 x 31.8 x 7.6)	241.7 (137.3)	58	162.4	-----
	2	48 x 48 x 8 (47.8 x 47.8 x 7.6)	363.3 (206.3)	46	152.0	-----
Grouted Concrete Block	5	24 x 24 x 8 (23.8 x 23.8 x 7.6)	180.9	118	274.8	0.253
	2	32 x 32 x 8 (31.8 x 31.8 x 7.6)	241.7	103	220.4	-----
	2	48 x 48 x 8 (47.8 x 47.8 x 7.6)	363.3	60	234.8	-----

Note: 1 psi=6.895 kN/m²; 1 in=25.4 mm; 1 in²=645 mm²

TABLE 2. - Results of Diagonal Compression Tests of Rectangular Specimens

Type of Masonry	Number of Specimens	Nominal (Actual) Size L x h x t (in x in x in)	Aspect Ratio $r = \frac{h}{L}$	Gross (Net) Area A (in ²)	Age (Age of Grout) (days)	$\bar{\tau}$ (psi)	Coeff. of Var.
Single Wythe Brick	2	8 x 16 x 4 (7.9 x 15.7 x 3.55)	2	28.0	28	985.7	----
	2	16 x 32 x 4 (15.7 x 31.8 x 3.55)	2	55.7	28	562.0	----
	2	16 x 8 x 4 (15.7 x 7.9 x 3.55)	0.5	55.7	28	324.6	----
	2	32 x 16 x 4 (31.8 x 15.7 x 3.55)	0.5	112.9	30	198.6	----
Double Wythe Grouted Brick	5	8 x 16 x 10 (7.9 x 15.7 x 10.0)	2	79.0	35 (28)	557.0	0.077
	5	16 x 32 x 10 (15.7 x 31.8 x 10.0)	2	157.0	34 (28)	455.1	0.039
	5	16 x 8 x 10 (15.7 x 7.9 x 10.0)	0.5	157.0	35 (28)	233.5	0.192
	5	32 x 16 x 10 (31.8 x 15.7 x 10.0)	0.5	318.0	39 (28)	335.0	0.051
Hollow Concrete Block	4	16 x 32 x 8 (15.5 x 31.8 x 7.6)	2	117.8 (69.9)	30	249.2	0.155
	2	24 x 48 x 8 (23.8 x 47.8 x 7.6)	2	180.9 (102.7)	66	212.4	-----
	4	32 x 16 x 8 (31.8 x 15.6 x 7.6)	0.5	241.7 (137.3)	35	140.9	0.133
	2	48 x 24 x 8 (47.8 x 23.8 x 7.6)	0.5	363.3 (206.4)	75	110.4	-----
Grouted Concrete Block	5	16 x 32 x 8 (15.5 x 31.8 x 7.6)	2	117.8	106	205.2	0.078
	2	24 x 48 x 8 (23.8 x 47.8 x 7.6)	2	180.9	83	144.1	-----
	5	32 x 16 x 8 (31.8 x 15.6 x 7.6)	0.5	241.7	109	195.3	0.093
	2	48 x 24 x 8 (47.8 x 23.8 x 7.6)	0.5	363.3	120	145.4	-----

Note: 1 psi=6.895 kN/m²; 1 in=25.4 mm; 1 in²=645 mm²

TABLE 3. - Diagonal Compression Tests of Precompressed Walls

Type of Masonry	Nominal (Actual) Size L x h x t (in x in x in)	Gross (Net) Area A (in ²)	Edge Load P _v (kip)	Diagonal Load P' (kip)	$\bar{\sigma}_y$ (psi)	$\bar{\tau}'$ (psi)
Single Wythe Brick	48 x 48 x 4 (47.7 x 47.7 x 3.55)	169.3	120.0	161.8	1384.6	675.8
Double Wythe Grouted Brick	48 x 48 x 10 (47.7 x 47.7 x 10)	477.0	90	375.0	744.6	555.9
		477.0	270	477.0	1273.1	707.1
		477.0	330	470.0	1388.5	696.7
		477.0	450	515.0	1706.8	763.4
Grouted Concrete Block	48 x 48 x 8 (47.8 x 47.8 x 7.6)	363.3	120	187.0	694.3	364.0
		363.3	210	207.5	981.9	403.9
		363.3	300	225.0	1263.7	437.9
Hollow Concrete Block	48 x 48 x 8 (47.8 x 47.8 x 7.6)	363.3 (206.3)	30	74.3	400.9	254.7
		363.3 (206.3)	60	98.0	626.7	335.9
		363.3 (206.3)	90	125.4	866.1	429.8
		363.3 (206.3)	135	100.0	997.1	342.8
		363.3 (206.3)				

Note: 1 kip=4.45 kN; 1 psi=6.895 kN/m²; 1 in=25.4 mm; 1 in²=645 mm²

TABLE 4. - Compressive Strength of Masonry Prisms

Type of Masonry	Number of Specs.	Nominal (Actual) Size L x h x t (in x in x in)	Gross (Net) Area A (in ²)	Age (Age of Grout) (days)	Average Comp. Strength f' _m (psi)	Coeff. of Var.	$\frac{h}{t}$	Modified Comp. Strength (psi)
Single Wythe Brick	7	12 x 8 x 4 (11.8 x 7.8 x 3.55)	41.9	30	5150	0.170	2.2	3902
	7	12 x 22 x 4 (11.8 x 21.4 x 3.55)	41.9	30	4309	0.065	6.0	4309
Double Wythe Grouted Brick	7	12 x 22 x 10 (11.8 x 21.4 x 10.0)	118.0	36 (28)	3350	0.113	2.2	2539
	16	12 x 46 x 10 (11.8 x 41.5 x 10.0)	118.0	36 (28)	3423	0.063	4.6	3368
	3	12 x 22 x 10 (11.8 x 21.4 x 10.0)	118.0	300±	4554	0.027	2.2	3452
	5	12 x 46 x 10 (11.8 x 41.5 x 10.0)	118.0	300±	4500	0.030	4.6	4427
Hollow Block	3	16 x 16 x 8 (15.5 x 15.6 x 7.6)	117.8 (66.6)	28	2962	0.184	2.0	2962
Grouted Block	10	16 x 16 x 8 (15.5 x 15.6 x 7.6)	117.8	28	3169	0.055	2.0	3169
	2	16 x 16 x 8 (15.5 x 15.6 x 7.6)	117.8	56	3116	-----	2.0	3116
	2	16 x 16 x 8 (15.5 x 15.6 x 7.6)	117.8	21	2255	-----	2.0	2255

Note: 1 psi=6.895 kN/m²; 1 in=25.4 mm; 1 in²=645 mm²

TABLE 5. - Test Results of Circular Specimens*

θ (deg.)	Diametral Load At Failure, P' (kip)		Splitting Strength f'_s (psi)	
	Test 1	Test 2	Test 1	Test 2
0	102.3	92.8	162	147
22.5	114.3	108.0	180	171
45.0	118.0	159.8	186	252
67.5	127.8	121.5	202	192
90.0	87.8	89.5	139	141

* Diameter = 52 in, thickness = 7.6 in (actual).

Note: 1 kip=4.45 kN; 1 psi=6.895 kN/m²; 1 in=25.4 mm

Although space limitations do not permit a detailed presentation of load-deformation data acquired during the tests, a brief description of the observed constitutive properties and failure mechanisms will help clarify the meaning of the tabulated failure loads.

Figure 2 exhibits the cracking patterns generally observed in the diagonal compression tests of the square brick specimens. In the single wythe specimens, cracking near the region of the loaded diagonal followed a rather well-defined staggered path along the mortar joints (Figs. 2b and 2d). This type of failure will be referred to as a "joint separation" failure to distinguish it from other failure modes. In the case of the 4-ft (1.22-m) grouted brick walls (Fig. 2e), the mode of failure cannot be identified with the same certainty because even though the outer brick wythes gave a clear indication of joint separation, inspection of the ruptured surfaces after dismantling indicated cracking of the grout core and part of the adjoining brick units along a more or less straight diagonal plane. This latter type of failure, when distinctly differentiable from joint separation, will be referred to as a "splitting" failure. The diagonally loaded brick specimens, including those with aspect ratios other than unity, ruptured suddenly under a well-defined peak load, which was used to calculate the $\bar{\tau}'_d$ values in Tables 1 and 2. The load-deformation response of these specimens was virtually linear throughout the entire loading range.

Figure 3 shows the superficial cracking patterns observed in the grouted brick walls that were tested under edge loads and diagonal compression. Subsequent examination of the ruptured surfaces left little doubt that these specimens had failed by tensile splitting. The $\bar{\tau}'$ values listed in Table 3 are determined from diagonal loads corresponding to the first discernible cracking of the specimens. In the case of the specimens with 90-kip (400-kN) and 270-kip (1200-kN) edge loads, the cracking load was coincident with the peak load attained during the test. For the other specimens, the first cracking load occurred at about 92 to 96 percent of the peak load. In all these tests, the deformations were typically linear with respect to the applied diagonal load up to the level of first cracking. The fact that some of the peak loads were slightly above the cracking loads is probably due to the confinement offered by the steel fixtures at the specimen boundaries.

Hollow concrete masonry walls tested in diagonal compression and various edge loads developed the cracking patterns shown in Figure 4. The specimens with zero edge loads clearly exhibited joint separation failures as noted in Figure 4a. On the other hand, the specimen subjected to the 135-kip (600-kN) maximum edge load used in the tests appeared to have failed by splitting (Fig. 4d). However, the possibility exists that the failure was initiated at the loaded corners where the high edge load may have caused a critical state of compression before the specimen could attain its tensile splitting capacity. This is further evidenced by the reversal of the trend noted in the test results (Table 3). Under intermediate edge loads, the specimens appeared to have failed initially by joint separation followed by cracking of some of the units as noted in Figures 4b and 4c. The P' values

listed in Table 3 are the diagonal loads at first notable cracking which were from 3 to 27 percent below the peak loads attained in the tests. As in the case of the brick walls, this apparent gain in strength is attributed to the confining effect of the steel fixtures where all the cracks terminated, and may not necessarily have structural significance in a practical situation. In general, the load-deformation characteristics of the specimens reflected the constitutive properties of concrete in compression (approximately linear to $f'_c/2$, progressively non-linear to f'_c). However, departure from linearity was not very significant even under maximum edge loads because the compressive stresses within the precracking range were low compared to the compressive strength of the prisms (Table 4).

Unlike the hollow specimens, fully grouted concrete masonry walls under edge loads and diagonal compression failed by splitting as evidenced by the cracking patterns illustrated in Figure 5. This trend is to be expected because orthotropic effects arising from differences in mortar and unit strengths is considerably diminished by the presence of grout which behaves like monolithic cast concrete. Due to low stresses at failure, there was no significant departure from linear behavior. In all cases cracking was very nearly coincident with the peak loads attained in the tests.

Figures 6a to 6e show the cracking patterns in the circular walls tested under diametral compression. In all cases except for $\theta = 22.5$ degrees, splitting occurred along the loaded diameter. For $\theta = 22.5$ degrees (Fig. 6b), cracking developed diametrically but in the direction normal to bed joint. This variance in direction was attributed to the presence of weak planes caused by the alignment of the center slots in the kerf blocks (see Fig. 4a) with the head joints in alternate courses.

5. SUMMARY

The following statements summarize major trends observed in the experimental results. A comprehensive interpretation of these tests and formulation of criteria for application in design are presented in a separate report.

The test results of diagonally loaded square specimens of three different sizes (Table 1) show remarkably good correlation of strength between medium size and large specimens for all four types of masonry tested. By comparison, the small specimens developed greater strength and/or variability. Thus, on the basis of these findings it appears that diagonal compression tests of 32-in.(813-mm) square concrete masonry specimens (hollow or grouted) and of 24-in.(610-mm) square brick specimens (single wythe or grouted), deserve to be given serious consideration as possible replacement of the 4-ft (1.22-m) walls that are currently specified in the ASTM E519 [1] test method. Such a revision will constitute up to 70 percent or more savings in materials and labor costs which, together with a reduction in headroom clearance requirements could bring about a nationwide acceptance of the shear prism test concept and its standardization.

By reference to Tables 1 and 2, it is noted that with one exception, diagonally loaded rectangular specimens of aspect ratios 2 and 0.5 developed respectively higher and lower strength in relation to the square specimens, reflecting the effect of changes in the direction of the applied loads with respect to the bed joints. The lower strength of the rectangular grouted concrete specimens in relation to the square specimens was the exception. This variance in trend is attributable to the presence of vertical planes of weakness caused by the slots located at the centers of the kerf blocks used in the construction of these specimens (Fig. 4a). This supposition is reinforced by the results of the circular wall tests (Table 5) where a loss (rather than an anticipated gain) in splitting strength occurred for values of angle θ less than 45 degrees.

According to the results shown in Table 4, the effect of slenderness (h/t ratio) on brick prism strength is at variance with the strength correction factors specified by the BIA Standard [14]. Note, for instance, that both short and long grouted brick prisms developed comparable strength while the modified values (last column in Table 4) obtained by applying the Standard-specified correction factors are significantly different. On the other hand, slenderness did affect the strength of single wythe brick prisms but not to the extent that would yield comparable strengths after modification according to the Standard. The tests also provided some information on strength gain with age. The grouted brick prisms tested at approx. 9 mos. after fabrication developed more than 30 percent higher strength than those tested at 36 days. In the case of the grouted concrete block prisms, however, the 56- and 28-day strengths were about the same while the 21-day strength was about 30 percent less. Also note that the variability of test results for the hollow concrete block and short brick prisms was in the order of 2 to 3 times greater than that for the other specimens.

Finally, the results compiled in Tables 1 and 3 show that the diagonal load capacity of masonry walls increases with increasing edge load. This is to be expected because within a certain range, compressive stresses due to edge loads reduce the critical tensile stresses developing under diagonal loading alone. Beyond that range, edge loads could trigger compressive crushing near the diagonally-loaded corners before the tensile splitting capacity can be fully developed.

6. ACKNOWLEDGEMENTS

The Cooperative Masonry Program which included this study was partly supported by financial grants from the Brick Institute of America (BIA), the National Concrete Masonry Association (NCMA), and the Tri-Services Building Materials Investigations Program Committee (Departments of the Army, Navy and Air Force).

All masonry specimens were fabricated by BIA and NCMA. Testing of all the small concrete and brick masonry specimens, including materials properties identification tests, were conducted respectively at NCMA and BIA and the test results made available to NBS. The large specimens (circular and square walls), and some of the brick prisms were transported and tested at NBS.

7. REFERENCES

1. ASTM E 519-74 Standard Test Method for Diagonal Tension (Shear) in Masonry Assemblages, Book of ASTM Standards, Part 18, American Society for Testing and Materials, Philadelphia, 1974.
2. Yokel, Felix Y. and Fattal, S. George, Failure Hypothesis for Masonry Shear Walls, Journal of the Structural Division, ASCE, March 1976.
3. Yokel, Felix Y. and Fattal, S. George, A Failure Hypothesis for Masonry Shear Walls, NBSIR 75-703, National Bureau of Standards, Washington, D.C., May, 1975 (includes formulation of hypothesis).
4. ASTM E 447-74 Standard Methods of Test for Compressive Strength of Masonry Assemblages, Book of ASTM Standards, Part 18, American Society for Testing Materials, Philadelphia, 1974.
5. ASTM C 216-71^E Standard Specification for Facing Brick (Solid Masonry Units Made from Clay or Shale), Book of ASTM Standards, Part 16, American Society for Testing and Materials, Philadelphia, 1974.
6. ASTM C67-73 Standard Methods of Sampling and Testing Brick and Structural Clay Tile, Book of ASTM Standards, Part 16, American Society for Testing and Materials, Philadelphia, 1974.
7. ASTM C 140-70 Standard Methods of Sampling and Testing Concrete Masonry Units, Book of ASTM Standards, Part 16, American Society for Testing and Materials, Philadelphia, 1974.
8. ASTM C 270-73 Standard Specification for Mortar for Unit Masonry, Book of ASTM Standards, Part 16, American Society for Testing and Materials, Philadelphia, 1974.
9. ASTM C 144-70 Standard Specification for Aggregate for Masonry Mortar, Book of ASTM Standards, Part 16, American Society for Testing and Materials, Philadelphia, 1974.
10. ASTM C 109-73 Standard Method of Test for Compressive Strength of Hydraulic Cement Mortars (Using 2-in or 50-mm cube specimens), Book of ASTM Standards, Part 13, American Society for Testing and Materials, Philadelphia, 1974.
11. ASTM C 476-71 Standard Specification for Mortar and Grout for Reinforced Masonry, Book of ASTM Standards, Part 16, American Society for Testing and Materials, Philadelphia, 1974.
12. UBC Standard No. 24-22 Field Tests for Grout and Mortar, Uniform Building Code Standards, International Conference of Building Officials, Whittier, CA, 1973.
13. ASTM C 39-72 Standard Method of Test for Compressive Strength of Cylindrical Concrete Specimens, Book of ASTM Standards, Part 14, American Society for Testing Materials, Philadelphia, 1974
14. Building Code Requirements for Engineered Brick Masonry, Structural Clay Products Institute (Presently Brick Institute of America), McLean, Virginia, August, 1969.
15. Specification for the Design and Construction of Load-Bearing Concrete Masonry, National Concrete Masonry Association, McLean, Virginia, 1970.
16. Timoshenko, S. and Goodier, J.N., Theory of Elasticity, McGraw-Hill Book Company, New York, N.Y., 1951.

8. NOTATION

- f'_m = unconfined compressive strength of masonry
 f'_s = apparent unconfined splitting strength of masonry
 h = height of specimen normal to bed joint
 r = aspect ratio h/L of rectangular walls
 t = thickness of specimen
 A = actual (gross or net) cross sectional area of specimen parallel to bed joint
 D = diameter of circular specimens
 L = Length of specimen parallel to bed joint
 P' = diagonal load capacity of specimens
 P'_d = diagonal load capacity of square specimens when $P_v = 0$
 P_v = resultant of distributed edge load
 θ = angle of inclination of bed joint with respect to horizontal in circular walls
 $\bar{\sigma}_y$ = nominal applied stress normal to bed joint
 $\bar{\tau}'$ = nominal shear strength of specimen
 $\bar{\tau}'_d$ = nominal shear strength of square specimen when $P_v = 0$

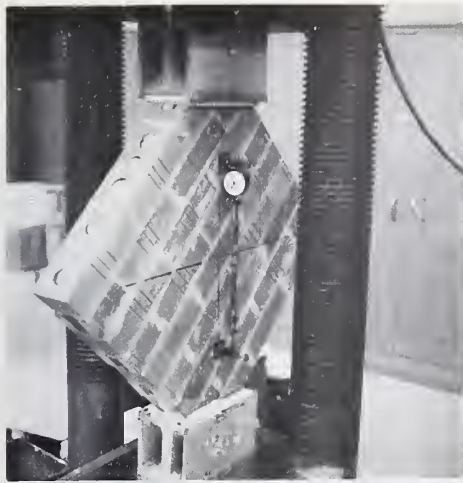

(a)



(b)



(c)

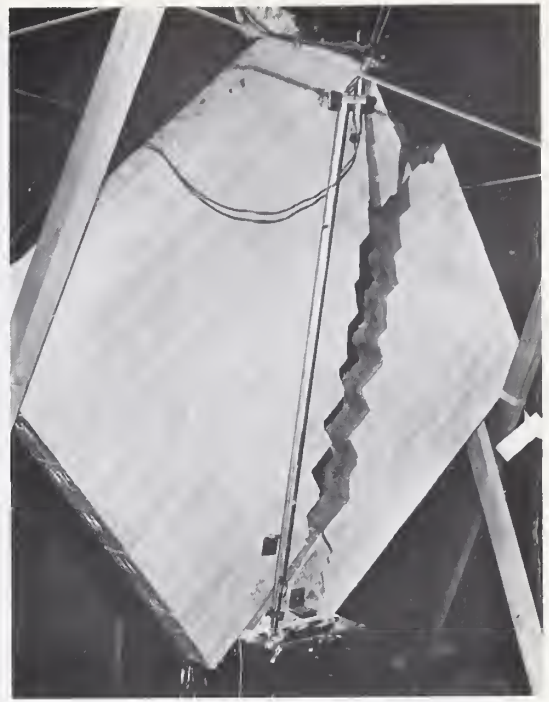

(d)

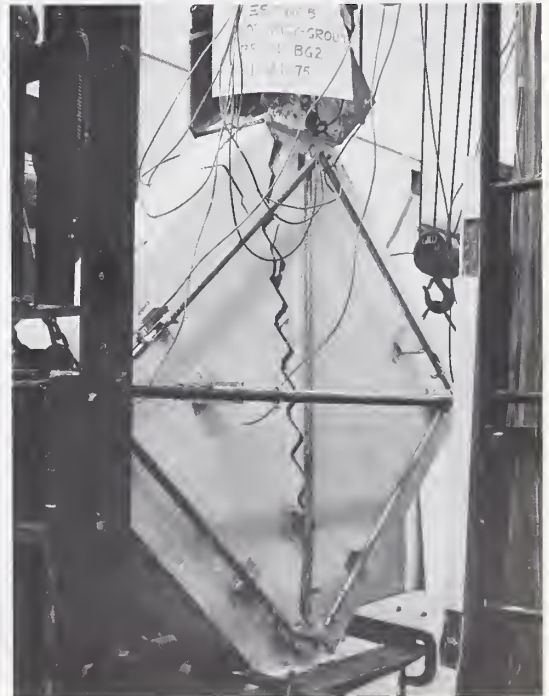

(e)

Fig. 2 Diagonal compression tests of square brick specimens



(a) $P_v = 330$ kips



(b) $P_v = 450$ kips



(c) $P_v = 90$ kips

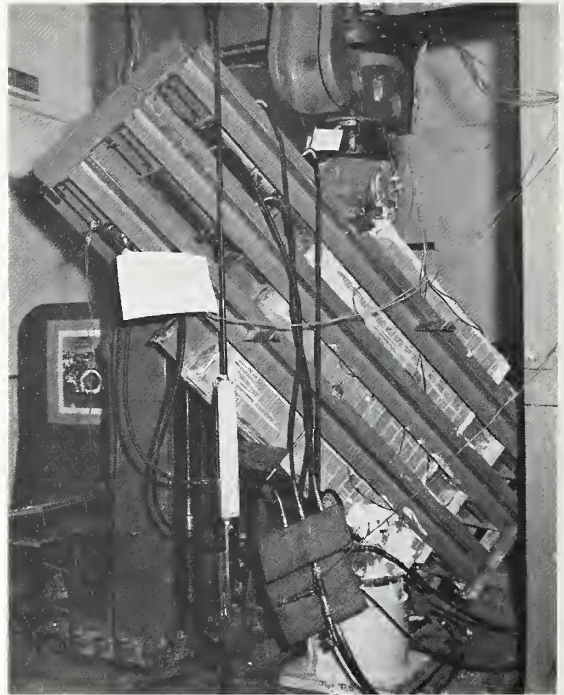

(d) Test Setup

Fig. 3 Diagonal compression tests of grouted brick walls with edge loads



(a) $P_v = 0$

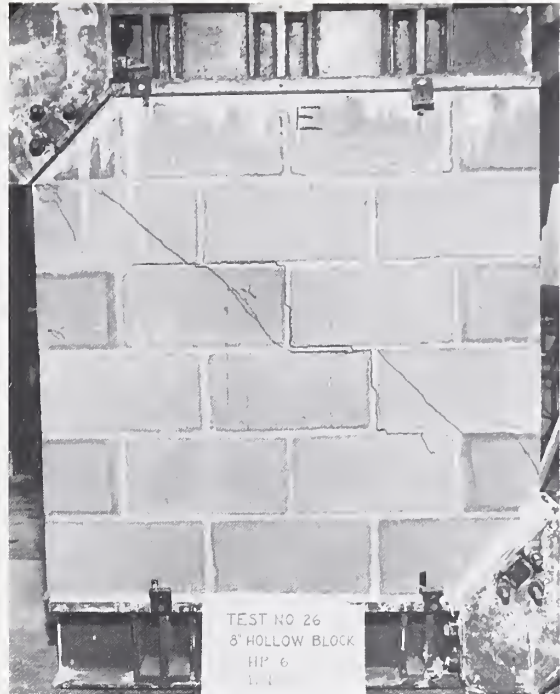

(b) $P_v = 30$ kips



(c) $P_v = 90$ kips

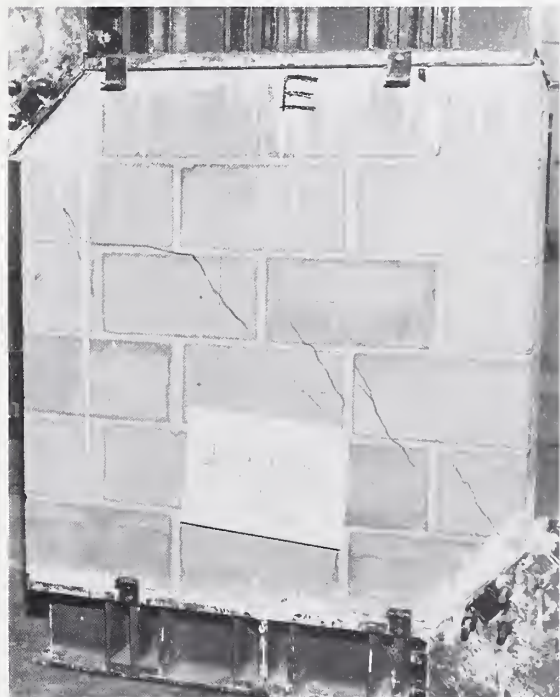

(d) $P_v = 135$ kips

Fig. 4 Tests of hollow concrete block walls

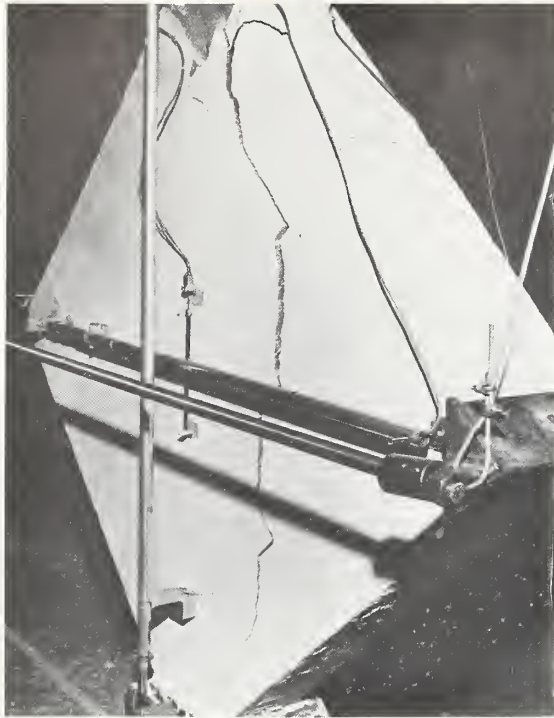

(a) $P_v = 0$

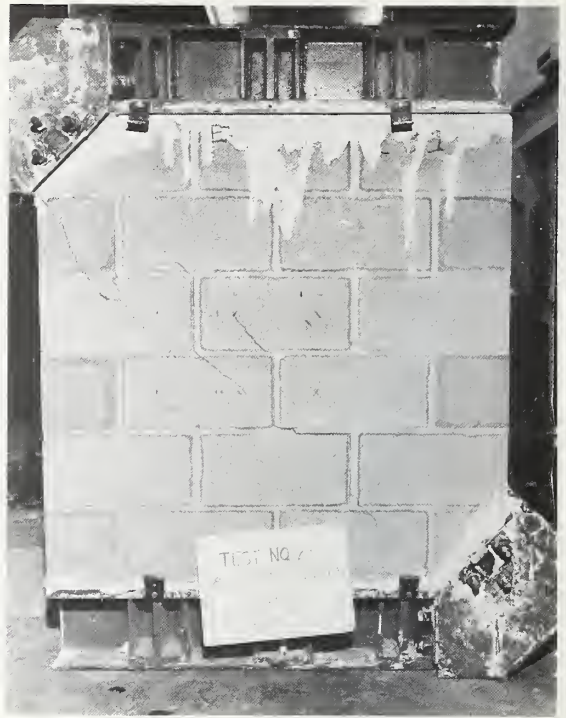

(b) $P_v = 120$ kips

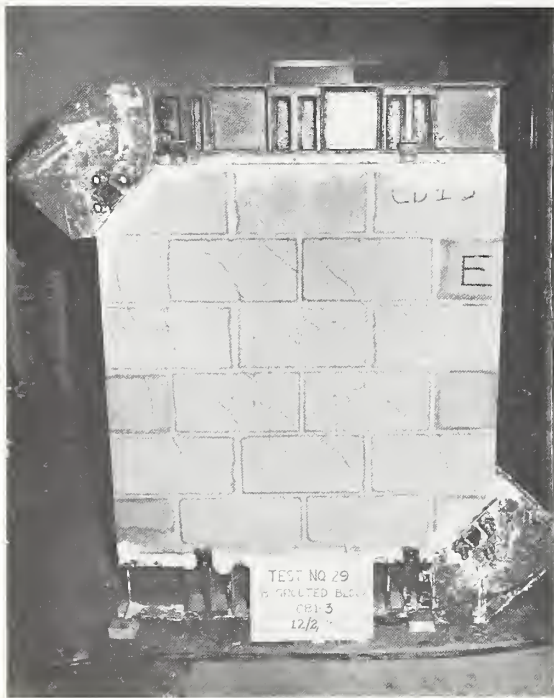

(c) $P_v = 210$ kips

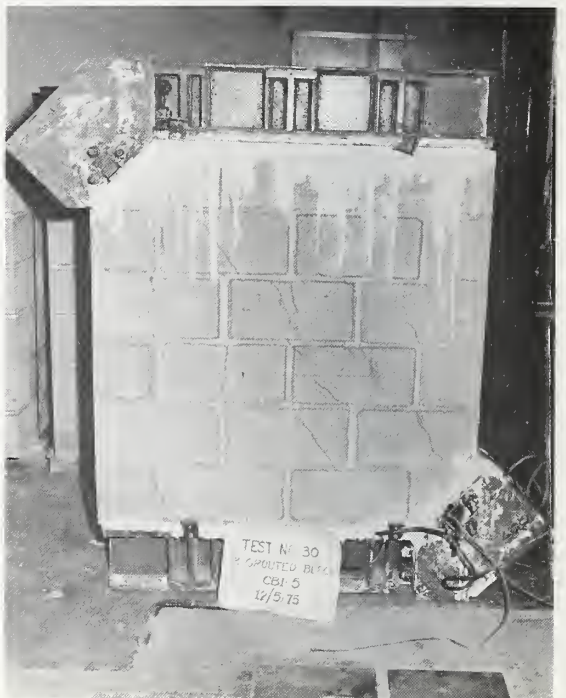

(d) $P_v = 300$ kips

Fig. 5 Tests of grouted concrete block walls

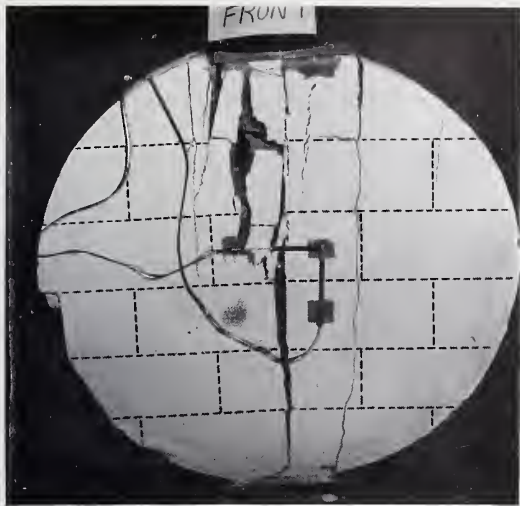

(a)

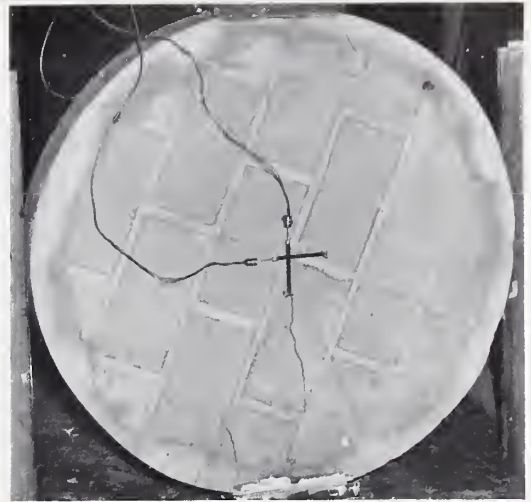

(d)

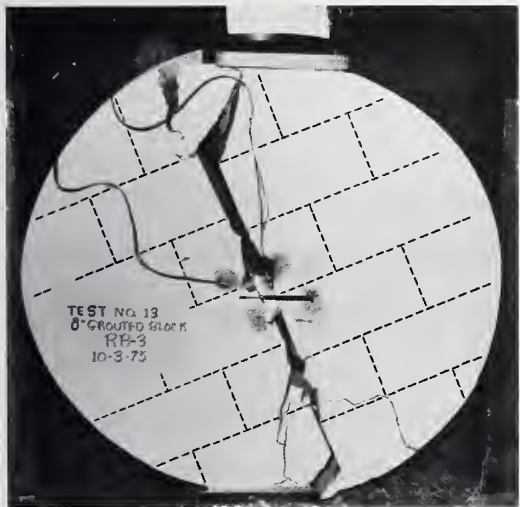

(b)

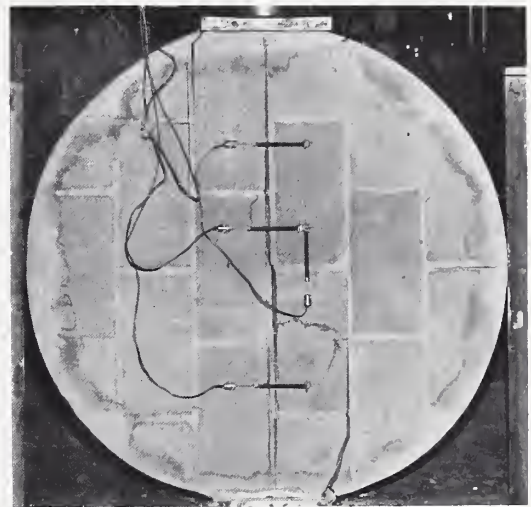

(e)



(c)



(f)

Fig. 6 Tests of circular grouted concrete block walls

CANADIAN CODE REQUIREMENTS FOR MASONRY IN EARTHQUAKE ZONES

A.H.P. Maurenbrecher
Division of Building Research
National Research Council of Canada

Abstract. This paper gives a short review of Canadian seismic requirements for masonry buildings contained in the 1975 National Building Code of Canada and in the proposed revision to the masonry code - CSA draft Standard S304 - Masonry Design and Construction for Buildings.

Key Words. Bricks; buildings; Canada; concrete blocks; design standards; earthquake resistant structures; masonry.

1. INTRODUCTION

Interest in the behaviour of earthquake resistant masonry (1,2) has been increasing in Canada over the past decade and more so recently since all buildings in seismic zones 2 and 3 have been required to be reinforced except for some one- and two-storey structures.

This paper gives a short review of Canadian seismic requirements for masonry buildings contained in the 1975 National Building Code of Canada (3,4,5) and in the proposed revision to the masonry code - CSA draft Standard S304 - Masonry Design and Construction for Buildings (6).

2. EARTHQUAKE DESIGN LOADS FOR MASONRY CONSTRUCTION

The Canadian seismic zoning map (Figure 1) is divided into four zones derived from the distribution of peak horizontal ground accelerations with an exceedance probability of 0.01 in one year (100-year return period) (7).

The seismic design requirements provide minimum standards meant to assure an acceptable level of public safety (8). The NBC (3) allows a dynamic analysis although a static analysis is more commonly used. The latter requires the building to resist a lateral force given by the following equation:

$V = (ASKIF)W$ which is similar to the 1974 SEAOC Equation (9) [$V = (ZCKIS)W$]

where A is the ratio of the horizontal design ground acceleration to the acceleration of gravity

= 0, 0.02, 0.04 and 0.08 for seismic zones 0 to 3 respectively.

S is a seismic response factor dependent on the fundamental period of the building

= $0.5/T^{1/3} \leq 1$ where $T = 0.05 h_n/D^{1/2}$

h_n = height of the building in feet

D = dimension of the building in the direction parallel to the applied forces in feet.

K takes into account the damping characteristics and the ductility of the building

= 1.3 for systems consisting of a ductile moment resisting frame with masonry infilling.

= 1.3 for reinforced masonry (= 2 if $H > 200$ ft (61 m) in zone 3)

= 2.0 for plain masonry.

I is an importance factor

= 1.3 for buildings housing essential services and schools

= 1.0 for all other buildings.

F is a foundation factor dependent on soil stiffness and depth

= 1.0, 1.3 or 1.5.

W is the weight of the structure

= dead load + 25 per cent design snow load + the weight of the contents of full tanks and, for storage areas, the full design live load.¹

Other considerations such as the distribution of the lateral earthquake load, overturning, torsion and loads on individual panels are similar to U.S. practice.

¹ If a structural member supports more than 900 sq ft (83.6 m²) a reduction factor is applied to the live load

The reduction factor J applied to the overturning moment is:

$$\begin{aligned} J &= 1 \text{ where } T \leq 0.5 \\ &= (1.1 - 0.2 T) \text{ where } 0.5 \leq T \leq 1.5 \\ &= 0.8 \text{ where } T \geq 1.5 \end{aligned}$$

where T is the fundamental period of the building.

3. CODE REQUIREMENTS FOR EARTHQUAKE RESISTANT MASONRY

Two parts of the NBC may be used for the design of masonry - Part 9 (4), which covers housing and small buildings only, and Part 4 (3,5), which covers all buildings.

Part 9

Part 9 contains simple empirical rules for the construction of houses and small buildings in plain masonry up to 6000 sq ft (557 m²) per floor and three storeys in height but not more than 36 ft (11 m) over-all wall height. It applies to all occupancies except assembly, institutional and high hazard industrial and excludes structures with concrete floors or roofs above the first storey.

In seismic zone 2, loadbearing masonry in 3-storey buildings must be reinforced horizontally and vertically with steel having a cross-sectional area of at least 0.2 per cent of the gross cross-sectional area of the wall. Not more than 2/3 of this steel may be installed in one direction. In seismic zone 3, these requirements apply to 2- and 3-storey buildings.

Part 4

Part 4 may be used for all masonry buildings. Two methods of design are covered - empirical design of plain masonry and engineering design of plain and reinforced masonry. Plain masonry may only be used in seismic zones 0 and 1.

The present design requirements for masonry are incorporated within NBC Supplement No. 4 (5) but they will be superseded in 1977 by CSA Standard S304 (1,6). The new standard has many revisions and additions together with an improved layout. Efforts will next be directed to producing an engineering design section based on limit states philosophy.

4. ENGINEERED DESIGN

The engineering code requirements are largely based (10) on the Brick Institute of America (BIA) Building Code Requirements for Engineered Brick Masonry (11) and the National Concrete Masonry Association (NCMA) Specifications for the Design and Construction of Load-Bearing Concrete Masonry (12).

Certain aspects of the engineered design section will now be reviewed.

4.1 Basis of Masonry Compressive Strength. Design stresses are derived from the ultimate compressive strength f'_m obtained from prisms or from tables based on unit strength and mortar type. Prisms with height to thickness ratios of 5 and 2 are the basis for brick masonry and concrete or clay tile masonry respectively. The compressive strength, based on a minimum of five prisms or units, is taken as the average strength less a reduction that takes into account the variation in results.

$$f'_m = f_{av} (1 - 1.5 v)$$

where f_{av} = average strength

v = coefficient of variation.

This is assumed to give a probability level of approximately 10 per cent (1 in 10 chance of individual values being less than the calculated value). The BIA code has a similar provision but no reduction is made unless the coefficient of variation exceeds 10 per cent for prism strength or 12 per cent for unit strength. Thus strengths based on the BIA code will be approximately 18 per cent higher than the Canadian code if the coefficient of variation is 10 per cent or greater. The tables for masonry strength based on unit strength give values only for masonry construction that is inspected since the Canadian code makes the designer responsible for inspection to ensure that the construction conforms with the design. Shop drawings, workmanship and materials are to be checked.

4.2 Allowable Stresses. The allowable stresses for plain and reinforced masonry are presented in a similar manner to those in the BIA code. The stresses applying to reinforced masonry walls are shown in Table 1. For comparison the stresses allowed by the 1973 Uniform Building Code (13) are also shown.

4.2.1 Shear Walls. The allowable horizontal shear stress in shear walls increases with dead load stress

$$= v + 0.3 f_{cs}$$

where v = permissible tabular shear stress

f_{cs} = average dead load stress at the level considered.

BIA gives a coefficient of 0.2. Note the maximum shear stress is limited by the above equation, not the tabular values.

4.2.2 Wind and Earthquake Loads. No increase in permissible stresses is allowed for either wind or earthquake loads. Instead, load reduction factors are used when three or more load combinations are considered. The following combinations should be considered:

D; D + L; D + Q; D + T

0.75 (D + L + Q); 0.75 (D + L + T); 0.66 (D + L + Q + T)

where D = dead load

L = live load

Q = earthquake or wind load

T = thermal, shrinkage, moisture and creep forces.

When calculating the shear stress in shear walls the present code does not allow load reduction factors when earthquake load is considered.

4.2.3 Reduction Factors for Slenderness and Eccentricity. The load reduction factors for slenderness and eccentricity are at present more conservative than the BIA code but the revised code has adopted the BIA values.

4.3 Minimum Reinforcement in Walls. In zones 2 and 3 reinforcement must be provided to resist the seismic forces and must not be less than 0.2 per cent of the gross cross-sectional area of the wall (see Table 2 for spacing). In the present code this minimum applies to:

- (a) loadbearing and lateral load-resisting masonry;
- (b) masonry enclosing elevator shafts and stairways, or used as exterior cladding; and
- (c) masonry partitions, except partitions which:

- (i) do not exceed 40 lb/ft^2 (1.9 kN/m^2)

(ii) do not exceed 10 ft (3 m) in height and are laterally supported at the top.

The revised code reduces the minimum requirements for non-loadbearing walls. It has a more rational approach and takes into account the different seismic zones and construction practice. The reinforcement may be placed in one direction with the minimum steel area in zone 3 reduced to half that required for loadbearing walls and reduced by half again in zone 2 or less (see Table 2). The designer must ensure that the reinforcement extends between lateral supports to the wall and that it is adequate to resist the design seismic forces. The changes mean that the reduced minimum requirements can be satisfied by placing wire reinforcement in the horizontal mortar joints. In cavity or two-wythe walls the reinforcement may be placed in one wythe but the area of reinforcement is based on the gross area of both wythes.

4.4 Anchorage Requirements.

4.4.1 Anchorage. When masonry is anchored to lateral supports other than masonry, metal anchors must be provided unless another approved bonding system is used. At vertical supports the anchors must be spaced at not more than 4 times the nominal thickness of the wall or partition and at horizontal supports, not more than 6 ft 8 in. (2 m).

The revised code does not allow wedges to be used for anchoring the top of a masonry partition to its horizontal support; the code now in use does allow it.

Anchorage of intersecting masonry walls shall be provided by metal anchors spaced not more than 32 in. (810 mm) vertically or by overlapping half the units of one wall with the units in the other wall for a distance equal to the thickness of the thinner wall. If excessive differential thermal movement is likely to occur, bonding by metal anchors is recommended. Other approved bonding systems may be used. Anchors bonding an interior wall or partition to another wall or partition must be capable of resisting 5 lb/ft^2 (240 N/m^2) applied normally to the interior panel.

4.5 Shear Walls and Their Intersections with Their Flanges. The present code provisions are similar to the BIA requirements but the revised code contains more detailed provisions. Wall intersections may be bonded:

- (a) so that at least 50 per cent of the units of one wall are embedded in the other (toothed joints are not allowed);
- (b) by concrete or grout completely filling vertical keyways and/or recesses to provide a bond similar to the first case. The compressive strength of the mortar or grout should equal or exceed that of the masonry. Horizontal reinforcement across the joint must be equivalent to at least 2 steel wires of 0.148 in. (3.8 mm) in diameter spaced 16 in. (400 mm) vertically.

In both these cases the permissible shear stress must not be exceeded.

Alternatively rigid steel connectors such as anchors, rods or bolts may also be used to bond intersections except in portions of reinforced shear walls in which the flanges contain steel subject to axial tension under load. Requirements are given for spacing, size, embedment, bond and shear.

5. FURTHER DEVELOPMENTS

All engineered masonry buildings in seismic zones 2 and 3 must be reinforced. This has caused many objections in zone 2 which has experienced little seismic activity. A closer look is needed into the behaviour of plain and reinforced masonry under the expected earthquake forces.

Research topics needing high priority are:

1. Design and behaviour of connections.
2. Minimum reinforcement for earthquakes.
3. Behaviour of reinforced masonry.
4. Thorough statistical investigation of masonry properties.
5. Detailed analysis of masonry stress-strain behaviour under axial and flexural compressive loads and shear loads. This should include the effects of cycled and long-term load.
6. Detailed analysis of masonry buildings that have been subjected to earthquakes (undamaged as well as damaged).

At the Division of Building Research tests will be conducted on prisms and walls to obtain statistical data on masonry properties such as axial and flexural compressive strength as well as stress-strain behaviour. As large a range as possible of units and mortar commonly used in Canada will be tested. An 800-ton (7.1 MN) wall test frame has been designed for this purpose.

This paper is a contribution from the Division of Building Research of the National Research Council of Canada and is published with the approval of the Director of the Division.

REFERENCES

1. Aylon, N.N. Highlights of the New Canadian Masonry Design Code - CSA Standard S304, Proceedings First Canadian Masonry Symposium, University of Calgary, Calgary 1976, p. 123-133.
2. McLaughlin, R.H.B. Earthquake Analysis in Design of Masonry Structures. Proceedings First Canadian Masonry Symposium, University of Calgary, Calgary 1976, p. 134-148.
3. National Building Code of Canada 1975, PART 4, Design, National Research Council of Canada, Ottawa. (NRCC 13982).
4. National Building Code of Canada 1975, PART 9, Housing and Small Buildings, National Research Council of Canada, Ottawa. (NRCC 13982).
5. Supplement No. 4 to the National Building Code of Canada 1975, PART 1, Plain and Reinforced Masonry, National Research Council of Canada, Ottawa. (NRCC 13989).
6. Canadian Standards Association, Draft Standard S304 - Masonry Design and Construction for Buildings, 1976.
7. Whitham, K., Milne, W.G., and Smith, W.E.T. The New Seismic Zoning Map for Canada - 1970 edition, The Canadian Underwriter, June 15, 1970.

8. Supplement No. 4 to the National Building Code of Canada 1975, PART 2, Commentary J - Effects of Earthquakes, National Research Council of Canada, p. 137-154. (NRCC 13989).
9. Structural Engineers Association of California, Recommended Lateral Force Requirements and Commentary, San Francisco, 1974.
10. Cutler, J.F., Plewes, W.G., and Mikluchin, P.T. The Development of the Canadian Building Code for Masonry, SIBMAC Proceedings, British Ceramic Research Association, England, 1971, p. 233-239.
11. Brick Institute of America (formerly SCPI), Building Code Requirements for Engineered Brick Masonry, BIA, Virginia, 1969.
12. National Concrete Masonry Association, Specifications for the Design and Construction of Load-Bearing Concrete Masonry, NCMA, Virginia, 1970.
13. International Conference of Building Officials, Uniform Building Code, Whittier, California, 1973.

TABLE 1

MAXIMUM ALLOWABLE STRESSES IN REINFORCED MASONRY

Type of Stress	NBC 1975		UBC 1973
	Brickwork ¹	Blockwork ²	Masonry ²
Compressive			
Stress in Walls:			
Axial	$0.25 f'_m$	$0.225 f'_m$	$0.2 f'_m$
Flexural	$0.40 f'_m$	$0.33 f'_m$	$0.33 f'_m \leq 900$
Shear			
No Shear reinf.			
Flexural	$0.7 \sqrt{f'_m} \leq 50$	$0.02 f'_m \leq 50$	$1.1 \sqrt{f'_m} \leq 50$
Shear } Wall }	$0.5 \sqrt{f'_m} \leq 100$ (+ $0.3 f_{CS}$)	$0.015 f'_m \leq 50$ (+ $0.3 f_{CS}$)	$0.9 \sqrt{f'_m} \leq 34$ to $2 \sqrt{f'_m} \leq 50$
Shear reinf.			
Flexural	$2 \sqrt{f'_m} \leq 120$	$0.05 f'_m \leq 150$	$3 \sqrt{f'_m} \leq 150$
Shear } Wall }	$1.5 \sqrt{f'_m} \leq 150$ (+ $0.3 f_{CS}$)	$0.04 f'_m \leq 75$ (+ $0.3 f_{CS}$)	$1.5 \sqrt{f'_m} \leq 75$ to $2 \sqrt{f'_m} \leq 120$
Bond			
Plain	80	80	60
Deformed	160	160	140

¹ f'_m for brickwork is based on a prism with a h/t ratio of 5.

² f'_m for blockwork and UBC masonry is based on prisms with a h/t ratio of 2.

TABLE 2

MINIMUM REINFORCING IN REINFORCED MASONRY WALLS

(Draft Standard S304)

	Minimum Reinforcement ¹			Spacing	
	% A _g			in.	
	Vertical	Horizontal	Sum	Vertical	Horizontal
<u>Loadbearing</u>	0.07	0.07	0.2	≤ 6t, 48	≤ 6t, 48
<u>Non-Loadbearing</u>					
Seismic Zones 0-2	0.017	0.017	0.05	≤ 6t, 48	≤ 6t, 48
or	0.05	0	-	16	-
or	0	0.05	-	-	16
Seismic Zone 3	0.033	0.033	0.1	≤ 6t, 48	≤ 6t, 48
or	0.1	0	-	16	-
or	0	0.1	-	-	16

¹ Minimum diameter of reinforcement - No. 9 ASWG (0.148 in. (3.8 mm)).

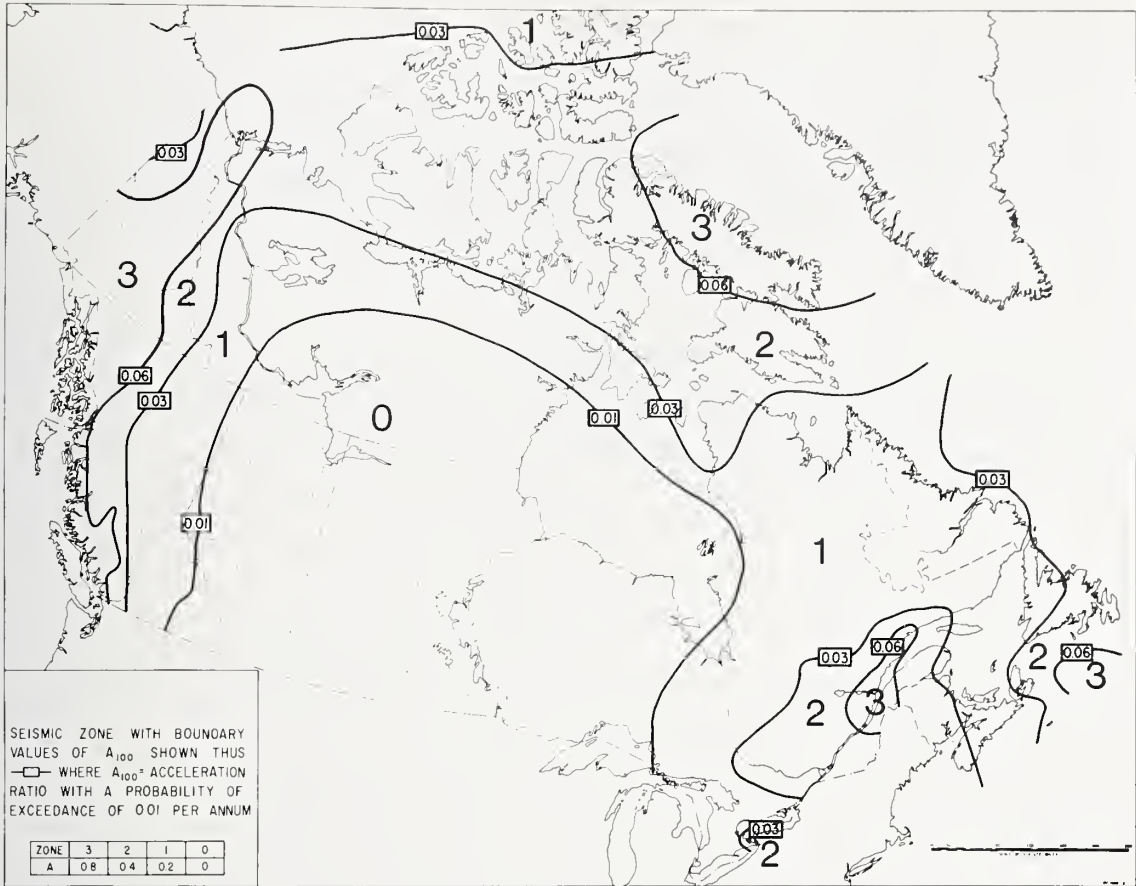

Fig. 1 Seismic Probability Map
 (from Supplement No. 1, National Building Code of Canada 1975)

DISCUSSION

* * * *

Lederer, City of Detroit:

Paul, [Maurenbrecher] did you say that there was no reinforcing requirement in Seismic Zones 0 and 1 in Canada? Did I catch that right; and that you do require reinforcing in 2 and 3?

Maurenbrecher, National Research Council, Canada:

There are no minimum requirements in Seismic Zones 0 and 1 but it is up to the designer to check that none is needed.

Mayes, University of California, Berkeley:

Paul, do you think that sufficient information exists so that you can move towards a limit state design for seismic problems? Are you confident that that is the way you will be able to go by 1979?

Maurenbrecher:

We don't have enough information on seismic problems for present design but this doesn't stop your writing a code in terms of limit states philosophy. Many countries have done so or are in the process of changing--for example Spain, Russia, Czechoslovakia, Netherlands and Britain. We still need much more information on material structural behavior but in the meantime conservative safety factors can be used.

Self, University of Florida:

I understood you to say that it is the designer's responsibility to see that the construction is built according to the plans and specifications?

Maurenbrecher:

It is the designer's responsibility to carry out inspection of the construction to check that it is built according to his plans and specifications.

Self:

What is the contractor's responsibility?

Maurenbrecher:

The contractor is also responsible for any work he undertakes.

Self:

I guess what I'm asking, really, (or fishing for) is whether or not the legal responsibilities differ in Canada and the United States?

Maurenbrecher:

I believe they do. If the National Building Code provisions are adopted by the municipality, not only is the contractor responsible for his work but in addition, the designer is responsible for inspection to see that his plans and specifications are followed.

Wakefield, Salt Lake City:

When you were speaking about the K factor, you mentioned that under 200 feet in height, you had a 1.3 and above 200 feet in height, you had a 2. Does that mean, also, that you do not have an arbitrary limit to the height of reinforced masonry structures, as they do in the UBC?

Maurenbrecher:

Not in the National Building Code although there may be in local codes. The National Building Code is a model code and it has no legal backing unless it is adopted by the municipalities.

Wakefield:

But I mean, as it stands there, you have no arbitrary height limits like some other codes.

Maurenbrecher:

No.

Wakefield:

Congratulations! Thank you.

Meehan, State of California:

Did you say that the responsibility for the construction is the designer's responsibility?

Maurenbrecher:

No.

Wakefield:

Is it necessary for the designer to do anything more than sign the plans?

Maurenbrecher:

In some cases a certificate must be signed stating the building has been built according to the plans and specifications. In many cases no certificate is required-- it all depends on the local municipality.

Wakefield:

Is there anything on file, and is there anything written?

Maurenbrecher:

Yes, it is written specifically in the code, that the designer. . .

Wakefield:

No, I mean after building, does the designer issue some sort of certificate?

Maurenbrecher:

Yes, he has to sign a certificate that the building has been completed according to his design.

Wakefield:

Thank you.

* * * *

AIR FORCE BUILDING CONSTRUCTION EXPERIENCES IN
RELATIONSHIP TO MASONRY SEISMIC DESIGN

Robert P. Reid, Civil Engineer
United States Air Force

(Oral Presentation Only
Followed by Discussion)

DISCUSSION
* * * *

Werner, Department of Housing and Urban Development:

Is there an Air Force policy requiring that if you are going to rehab an existing structure, it should also be strengthened for the Seismic Zone of the area?

Reid, U.S. Air Force:

Yes, if we rehab a facility in an existing seismic area and the facility was constructed before the newest addition of our risk map, during the rehabilitation we will make every effort to bring it to the standards prescribed by the seismic area for new construction. I must throw in a caveat here, though. Sometimes we give a little. For example: we had a building in St. Louis which used to be the Air Force Aeronautical Chart and Survey Service (or something like that; anyway, it made all of our maps for us). Several years ago an organization was formed directly under the Secretary of Defense, called the Defense Mapping Agency and it took the Army's activities, the Air Force's and the Navy's and put them under one great, large organization. However, they assigned construction and design responsibility for their facilities (now under the Defense Mapping Agency) to the federal agencies who originally had them. So, we got that building in St. Louis. About a year and a half later, they came in with a project to add onto it. The seismic risk zone in which St. Louis is located had changed in the mean time (from about 1923 to 1974); and the addition required seismic reinforcement which was conspicuously absent in the existing building. We told our people that this is the way it is; design it. We had all sorts of complaints from the local AE and the contractor who said that nothing else in St. Louis was ever designed and built this way. Well, we backed off on

the grounds that if we had to go into the existing building and build shear walls in it, and all sorts of other things, we would so disrupt the production of the maps that are so sensitive to national security that we should waive the requirement in this one case. I suspect that things like this will continue to happen. We're going to give it a good try but I can't promise 100% success in every instance.

* * * *

HEW ACTIVITY IN MASONRY
DESIGN AND CONSTRUCTION

Ross M. Webb*
Department of Health, Education, and Welfare

I. INTRODUCTION

The Department of Health, Education, and Welfare owns about 2500 buildings in the United States which incorporate masonry construction in one form or another. These buildings are a part of the Nation's health, education, and welfare systems. They are:

- (1) Schools on military bases and Indian reservations;
- (2) Indian Health and Public Health Services hospitals;
- (3) Special purpose health and education related research facilities; and
- (4) Office buildings of the Welfare component of the Department.

We have two basic construction programs: (1) Direct Federal Construction, in which we are the Contracting Officer responsible for the design and construction of Department-owned facilities; and (2) Federally Assisted Construction - This program actually is a variety of grant and loan programs providing Federal financial assistance for construction of health and education related facilities. This past year, the total HEW construction activity was \$9.1 billion, of which approximately \$150 million was for construction of Department-owned facilities.

II. SEISMIC DESIGN CRITERIA

Our criteria for seismic design are those of the State or local code, or the Uniform Building Code (UBC), whichever are the more stringent. We deviate from the UBC in special cases when the site seismicity is determined to be different from that provided for by code. Major deviations generally are attributed to consideration of the maximum probable and maximum credible events that may occur at the site of a hospital building.

III. INFLUENCE OF LOCAL SOILS

There are cases where local soil conditions exerted considerable influence on the building design due to consideration of liquefaction; and site-soil resonance with wave periods arriving from far distant epicenters have influenced building and utility designs. Consideration of wave lengths, amplitudes of ground surface displacements, and geometry of the structure, of course, are important factors in considering long-period wave effects on site facilities. The effect of proximity of adjacent structures on ground response may be a factor to be investigated in the design of critical facilities which must remain operational after a seismic event. To the best of my knowledge, however, we have not seriously considered this factor.

* Structural Consultant, Office of Facilities Engineering and Property Management

IV. EVALUATION OF EXISTING BUILDINGS

Four years ago, we started a small program for structural evaluation of our older hospital buildings constructed during the early 1930's and 1940's. Ten buildings were selected for evaluation. These buildings were located in relatively low seismic areas or on the fringe of known tornado belts. They mainly were of one or two story non-reinforced masonry construction with wood-truss framed roofs.

In consideration of modern-day codes, these structures provided little, if any, seismic resistance. If one considers the present state-of-the-art, however, some of the buildings looked fairly good - looked fairly good in that they were short period buildings located on firm to hard soils and from 70 to 150 miles from known causative faults. Ignoring the risk due to tornado and for those buildings that were not structurally or programmatically obsolescent, the decision to rehabilitate to provide seismic resistance in accordance with the code was difficult. The decision especially was difficult when the contract architect/engineer was reluctant to provide information concerning:

- (1) The spectrum of ground motions to occur at the site;
- (2) The strain dependency of damping and frequency of structural elements;
- (3) Analysis of wood-truss frame roofs not having adequate bracing or bottom-chord diaphragms;
- (4) Similitude relation between model and prototype of structural elements; and
- (5) Compatibility of deformations between diaphragms and structural supports.

Use of the different methods suggested in the proposed revisions to the UBC for determining the site-soil resonance factor, S , and the soil-period, T_s , raised questions, for there was considerable spread in the answers for somewhat similar soil profiles.

V. MAJOR CONCERNS

The responsibility for life safety of the hospital buildings evaluated is the responsibility of the Government, so appropriate action was taken. But, in our Federally Assisted Construction Program, many owners of private buildings are not sympathetic to requirements for upgrading to provide seismic resistance, especially so when their State or local code makes no provision for earthquake. Therefore, we have a major concern that due to differences in code requirements for earthquake, we will experience difficulty in obtaining compliance with nationally recognized code provisions.

Another concern is how do we best structurally rehabilitate a building to provide seismic resistance. The answer, of course, may be unique for each building; but in consideration of the response spectrum, it is obvious that damping and ductility are

major factors to be investigated. For masonry construction, possibly slotted-wall concepts seriously should be investigated.

VI. CLOSURE

In closing, I sincerely hope that one outcome of this workshop will be to bring some of us in the profession out of the dark age in masonry design - both statically and dynamically - through implementation of a thoroughly evaluated program for masonry research.

U.S. ARMY CORPS OF ENGINEERS REQUIREMENTS FOR
SEISMIC DESIGN OF MASONRY

John L. Lybas, Structural Engineer
U.S. Army Construction Engineering Research Laboratory

(Oral Presentation Only
Followed by Discussion)

DISCUSSION
* * * *

Hegemier, University of California, San Diego:

I might have missed something; evidently, I did. What classes of structures were you talking about? How many? Can you say something about that?

Lybas, U.S. Army Construction Engineering Research Laboratory:

Yes. The construction of the Corps is, except for hospitals, mostly buildings that are three stories and under. This is mostly because there is a federal requirement which says that anything over 3 stories has to be provided with elevator facilities and this of course, becomes an economic thing. But there are several hospitals that are 6, 7 and even 8 stories. Therefore, in most cases, the maximum height requirement of about 80 feet is not really not an important thing because there are only a few buildings like that anyway. It's mostly our hospitals that we are concerned about, among buildings that are over 3 stories. Although, we do have quite a few lower masonry structures.

Hegemier:

What kind of numbers, hospitalwise, are we talking about? How many buildings -- just an order of magnitude?

Lybas:

I don't know if I could answer that. I don't really have a feel for how many there are.

Hegemier:

Well, hospitals, primarily of masonry construction?

Lybas:

Probably not too many. Most of our hospitals are reinforced concrete. In fact, probably the greater bulk of our buildings are reinforced concrete. Masonry is sort of a secondary problem for us, next to our problem of reinforced concrete.

Scalzi, National Science Foundation:

Do you do your complete design or do you farm it out to AE firms?

Lybas:

About 80% of it is farmed out. As to the requirements, we have design manuals and design requirements; we adopt a combination of SEOC along with the ACI code with a certain amount of modification. The Office of the Chief of Engineers provides the requirements and control over the whole operation.

Scalzi:

What reaction do you get from the AE's when you ask for a seismic design in all regions of the country that are listed as seismic risk zones?

Lybas:

Well, of course, this isn't a problem that I face directly, working at the research lab. The people at OCE have told me that there is often a certain amount of difficulty; that there is a certain amount of resistance from the AE's. There is even a certain amount of difficulty, at times, in finding many parts of the country that haven't been zoned as seismic in the past. There is difficulty in finding consultants that they feel have the background and know-how to do the work.

Scalzi:

Thank you.

* * * *

NAVFAC INTERESTS IN EARTHQUAKE RESISTANT MASONRY CONSTRUCTION

Joe V. Tyrrell
Director, Civil-Structural Division
Naval Facilities Engineering Command
Department of the Navy

The Naval Facilities Engineering Command utilizes the tri-service manual, Seismic Design for Buildings, designated NAVFAC P-355 by the Navy. This manual is managed by the U.S. Army, Corps of engineers, and is coordinated through the ad-hoc tri-service committee for structural engineering. The manual makes basic reference to the SEAOC code. The section on masonry construction includes typical details and minimum requirements for reinforcing. The manual is scheduled for revision in 1977.

NAVFAC is particularly interested in investigations which would verify the minimum reinforcing requirements for masonry walls. We would also like to see panel tests (for racking, etc.) on walls constructed from frequently used combinations of materials such as brick and concrete masonry units. A particular area of concern is the requirements for cavity walls which are very popular in many parts of the country and are of particular importance because of energy considerations. Finally, we would like to see more research on connections of walls to floors and foundations.

While NAVFAC has not sponsored recent research on the earthquake properties of masonry construction, we have conducted pilot surveys of existing facilities and are initiating a program to survey and up-grade seismic safety in areas of high risk. The initial results indicate that only about 5% of existing buildings are seriously deficient with respect to earthquake safety but some of these represent unacceptable hazards. Selective improvement appears to be worthwhile and feasible and some projects for improvement have been developed.

One of the categories of structures found to be most often vulnerable to earthquake damage are old masonry structures employing heavy bearing walls. We would like to see research on evaluation of such walls and methods of structural reinforcement.

SUMMARY OF THE VETERANS ADMINISTRATION ENGINEERING PROGRAM

Patrick M. Sears
Civil Engineering Service
Veterans Administration

The February 9, 1971 San Fernando Earthquake destroyed or severely damaged four major hospitals including two patient-occupied buildings of the Veterans Administration Hospital that collapsed. The VA buildings were designed and constructed prior to the development of modern seismic codes.

The Veterans Administration has 171 hospitals in the U.S. Of these, 68 are in active or semi-active earthquake areas. Most of the 68 hospitals have some unreinforced masonry. The buildings in these hospitals range in age from 6 or 8 years old to well over 70 years. The total money investment is in the billions of dollars and, of course, the replacement cost would be many times the original cost.

After the San Fernando Earthquake, it was decided that the VA hospitals would be strengthened to withstand any earthquake that might be expected in their areas in the next 100 years. This involved a structural evaluation of the 68 hospitals, and each hospital usually has many buildings.

The first thing that was done was to write a new structural code -- the VA's H-08-8. In H-08-8 there is an outline of what must be done in a structural evaluation. Briefly this is as follows:

1. A Site Survey is done - this is essentially a geological/seismic evaluation of the hospital site and the principal pieces of information from this effort are the 100-year earthquake intensity and maximum ground acceleration.
2. Phase I Architect/Engineer evaluation of the hospital buildings. The consultants (A/E) write a report telling the VA what, if anything, is wrong with the buildings when considering the 100-year earthquake.
3. Phase II Architect/Engineer evaluation of the buildings. In this phase the

A/E writes a report telling the VA how best to fix understrength buildings and how much this would cost.

4. Phase III produces plans and specifications. After Phase III construction starts.

When a structural evaluation of an existing VA hospital building is made it is very likely to concern the question - "How much load can the unreinforced masonry walls take?" To answer this question a program of testing samples taken from walls of existing buildings was started.

In the beginning of the testing program, sampling and testing of the wall specimens was conducted generally in accordance with the National Bureau of Standards recommendations. This entailed cutting a wallette approximately 1 1/2 feet square out of the existing building walls and testing by applying a compressive load across the diagonal. The cost per sample is \$2,000 including the sample cutting, testing and patching of the hole. It should also be mentioned that such an operation almost necessarily causes some disruption in hospital operations.

It was decided that something less expensive and less disruptive was very desirable.

For this we turned to cylinder cores taken from the walls. A problem is encountered here because the results of cylinder tests do not quite correlate with the results of wallette tests.

Testing Engineers, Inc. undertook to examine this problem. In the test program which was run by Mr. F. R. Preece, shear strength values were obtained from wallette samples and from cylindrical core samples. Mr. Preece found that close agreement between the two methods was reached by including the influence of internal friction.

The cylinder core sample has two big advantages over the wallette type sample. First, the cylinder core costs only \$200 per sample versus the approximately \$2,000 cost per wallette sample. Second, a cylinder core can be taken and the hole repaired relatively

quickly, with a minimum of disruption of hospital functions, whereas cutting and replacing a wallette sample is disruptive.

When using a wall to resist earthquake or wind generated lateral forces, two types of loading must be considered by a structural engineer. The first is out-of-plane loading (loads perpendicular to the wall). This loading causes bending which gives rise to tensile and compressive stresses on either side of the wall. Quite often with higher ground accelerations, the walls are unable to take these stresses, but usually in areas where earthquakes are not too severe the walls will survive the out-of-plane forces. Dr. Gabrielsen of San Jose University has shown experimentally that unreinforced masonry can survive quite high, repeated reversing loading if the walls are contained within columns and beams. The phenomenon is described as arching.

After assuring that a wall can survive out-of-plane forces which induce bending, the next loading condition for the wall is in-plane shear. In addition to gross shear stresses on the wall, this loading causes pier bending which causes tensile and compressive stresses at either side of the pier.

Thus, the Veterans Administration needed data pertaining to the tensile and shear ultimate strengths of existing masonry buildings. These values are gotten by direct sampling and testing (coring) of the existing walls. The values of ultimate tensile and shear stresses are then translated into allowable stress (via NBS approach, which by the way, has been incorporated as part of the VA's Standard H-08-8). These allowable stresses then determine whether a wall must be reinforced and whether it is a viable structural element (shear wall) which is capable of resisting forces.

The Veterans Administration now has almost finished its program of testing wall cores and the results, to no one's surprise, can be characterized as extremely varied. Shear ultimates run from almost zero to well over 300 psi. These include sample results from brick, concrete block and clay tile. The samples are from all over the country and represent almost the full range of age and workmanship that can be found in unreinforced masonry.

During the progress of the seismic program, the VA has found that quite often walls that might look at first to have no strength and thus no influence on building reaction to earthquake forces are in fact quite strong and also do constitute major load paths.

The VA also found that even when the walls are understrength, a strengthening procedure that has come to be known as the Boise method (building another wall on the outside of the old one) can economically (\$15 to \$30/ft²) strengthen old buildings.

The VA has found that almost never does it have to demolish a building because of understrength condition. The building can almost always be brought up to strength by economical strengthening procedures.

DISCUSSION
* * * *

Redmond, National Concrete Masonry Association:

What kind of rig did you use to cut the circular specimens out of the existing walls?

Sears, Veterans Administration:

I should not have used the word "we". We contracted this out to various testing labs throughout the country and it was a circular saw, usually. I came to distrust some of the results because when somebody cuts a specimen from a wall that has been there for a while, and it falls apart before they can get it out of the wall, I think, usually, that they have goofed somehow. To answer your question, there were all kinds of ways; whatever they had on hand was used.

Redmond:

What was the general diameter?

Sears:

About 5 1/2 inches in diameter.

Self, University of Florida:

Does your program extend to a survey related to wind forces as well as seismic?

Sears:

No. The program that I am associated is purely seismic; someone else in my same office is the wind man.

Self:

I see. Just before coming here I received an invitation to submit, not a proposal, but a letter of interest with respect to a survey for wind forces. I thought that maybe you were. . .

Sears:

I'm not really familiar with that. Sorry.

Wakefield, Interstate Brick Company:

Did you have a specific angle when you tested them? And would you tell us why, please?

Sears:

Fifteen degrees. That was what Preece recommended.

Yorkdale, Brick Institute of America:

Would you describe, if you can very briefly, some of the procedures that you used in these strengthening methods or these upgrading methods?

Sears:

I believe their number approaches, or exceeds, the number of the A & E's we have on board working on the project. Usually, an understrength building can be brought up to strength by addition of a shear wall in both directions. We are almost precluded from working inside a building. It is not a complete prohibition but it almost is because when you do construction inside a hospital building you have to move the patients out. The doctors will not work where there is construction going on. Masonry buildings are, in our case, usually three stories or less. We have some high-rise buildings, and they are a special case. They are usually steel, or reinforced concrete frame. So what we end up doing, is putting a new shear wall on the outside of the building - usually all around it.

Amrhein, Masonry Institute of America:

Have you used surface bonding material for your rehabilitation? For example, Surewall or BlocBond?

Sears:

I'm not familiar with that. Could you describe it a little more?

Amrhein:

Yes. It is basically a mixture of portland cement and glass fibers that is plastered onto the wall to about an 1/8 of an inch thickness and it gives a structural skin to the surface.

Sears:

No, I haven't seen that one come up; I'd be interested in seeing what you have on it.

Amrhein:

I'll send it to you.

Questioner:

This, perhaps, is not a fair question to you [Sears], but to the gentleman [Amrhein] who just responded: Are there any dynamic test results with regard to the surface bonding method that you were just talking about?

Amrhein:

Yes, there has been quite a bit of research done on this particular material in out-of-plane flexure, compression, and racking tests.

Sears:

If any of you want a copy of our H-08-8, (we're rather proud of it) just let me know and I'll mail you a copy.

* * * *

SEISMIC REQUIREMENTS OF THE PHOENIX CONSTRUCTION CODE

R. C. Hildebrandt
Assistant Director
Building Safety Department
City of Phoenix

I'm sure that the reason I was invited here was to express a point of view from the Phoenix Building Safety Department, so that's what I'll do right now, and save the philosophical points for later arguments. I bring you greetings from the desert.

Let me speak as a local, city building official. Phoenix has its own Construction Code. We think it is the best such Code in print - not because it is perfect in its content, but because of the system we follow in creating. We have our own Code - not because we think we're technologically smarter than everyone else, but so that our local industry, professionals and other citizens can have a say in what the Code requires. At any given time, one hundred or more such people are active in Phoenix Code review work.

Our Code has a masonry chapter - Part 21 - as well it should, since Phoenix is among the nation's leaders in per-capita use of masonry. We have a seismic design section too - not because we have either a history or demonstrated likelihood of any significant seismicity, but because someone, in their wisdom, decided that Arizona should be in Seismic Zone 2. We sometimes feel that we are in greater danger of being swallowed up by the presence of the San Andreas Fault than we are of being physically damaged by its tremors.

Following our usual custom of knowledgeable participation, the Phoenix Code seismic requirements have just been rewritten. They're brand new--won't become law until the City Council formally adopts them. This work was preceded by an affirmative answer to the question, "Is there a problem?" In this case the answer was "yes," not because of earthquake-caused failures, but because of unrealistic Code requirements. So it was done, and I have copies for most of you for your information. Some with soil interaction backup, and some simply with the proposed Code writing.

We'd like to do the same thing with masonry, because our masonry section, as well as that of any code of which I am aware, just isn't all that swift. But--is there a problem? Are the masonry buildings being built in Phoenix unsafe or inadequate because of deficiencies in masonry code requirements? I don't know, but I do know we could use help in arriving at simple answers to some fundamental questions involving masonry performance, earthquake or not.

1. Shear reinforcement - How much is required and where, and just what do we want it to do anyway? Does X-cracking really pose any dangers?
2. How much reinforcement is necessary for a wall to be considered "reinforced masonry?"
3. H/t ratios - Are our present common maximums necessary and rational?
4. Joint reinforcement - How effective is it?
5. Six-inch walls - Can we safely extrapolate from customary 8-inch standards?
6. Are we making progress toward a "rational design" procedure for masonry?
Or should we?
7. What do we know about new masonry methods such as surface bonding and the latest form of mortarless block? What do we want to know?

For well over 25 years, I have been in trade association work, employed by a construction material supplier, been a licensed contractor, a practicing engineer, served as President of the Structural Engineers Association in two states, managed a prestressed concrete plant (including a Tomax, prefabricated masonry wall operation), and now a building official. Perhaps I thus approach the questions at hand with too much of a mixed bag of views, but I must express the hope, as a structural engineer, that we don't fall into the structural engineer's trap of over-sophistication out of our love for 6th decimal point precision. Years ago, as a consultant, our office designed a six-story, post-tensioned lift slab structure in Seattle. It was called the "Four Freedoms." At the same time, unknown to me, someone else was designing a six-story, post-tensioned lift slab structure for Anchorage - "the Four Seasons." During the Alaska earthquake, whenever that was, the Four Seasons collapsed, and I worried. A later earthquake in Seattle did nothing to the Four Freedoms, but I'm first to admit that if the Good Lord had made

a fault occur between our lateral support cores, our building would have collapsed too.

At about the same time, I designed a County Civil Defense Center. It was to be nuclear-blast resistant. I studied for weeks, night and day, on trying to achieve proper dynamic resistance, until I found the words that set me straight. "If you design for ground zero, two miles away, and a 5-kiloton bomb, how will your building perform if a 3-megaton bomb lands on the roof?" I don't know how to design to resist the forces of the millennium. None of us do. So I guess I'm committed to avoiding being overly impressed with the scientific ability to play "what if."

Local codes are nothing more than the expression of local public policy, and policy is not what we intend, but what we're willing to enforce. What is needed by building officials, engineers, architects--all of us in the construction industry--is simplicity, reality, and common sense.

DISCUSSION
* * * *

Mayes, University of California, Berkeley:

I'm just interested, as a non-U.S. citizen, with your attitude toward your local building code. If a natural disaster such as an earthquake did hit Phoenix, would you turn to the U.S. government for help or do you accept complete responsibility for your codes as they stand now?

Hildebrandt, City of Phoenix:

Well, there is no single way to answer that, of course. ("Have you stopped beating your wife?")

I personally would not; I believe that I can say that, reflecting the viewpoint of the attitude of the people who make the decisions in Phoenix. No! It is not that we are saying that earthquakes are to be ignored. We don't believe there is any likelihood that there is going to be any significant seismic damage to construction in Phoenix. And, when I say we, I can say it collectively because that is the attitude reflected by the subcommittee of our building safety advisory board that wrote that revised document; and they relied heavily on both ATC-3 and the VA studies (of which they speak very highly) in reaching that conclusion.

Scalzi, National Science Foundation:

Does the State of Arizona have a state geologist, seismologist, etc.

Hildebrandt:

Not really.

Scalzi:

How did you evaluate the hazards?

Hildebrandt:

The best way we could. We had a consulting civil engineer, George Beckwith, who is actually a soils engineer, and very highly thought of in that profession in the State of Arizona. He is not a public employee; he is a private consultant. He served as the soil study advisor to the subcommittee that studied the question of revising the seismic code requirements.

Werner, Department of Housing and Urban Development:

Regarding the code changes that have been proposed, and which you have shown here, there was a committee, I take it, of professionals that developed the code changes. Was there any input from the public? Or, what happens now in terms of citizen input as to whether they are willing to accept the level of seismic safety proposed for Phoenix?

Hildebrandt:

Our procedure in the case of any proposed code revision is the same. We have a Building and Safety Advisory Board which is appointed for rotating overlapping terms by the mayor and the council (for longer periods of time than either the mayor or council serve). When a question comes forth that appears to be legitimate, a committee is formed. In this case, it appeared, not to the Building Safety Department necessarily, but to everyone doing design in Phoenix, that the seismic code requirements were requiring a far higher level of sophistication, complexity and expense than was warranted. The Building Safety Advisory Board appointed a committee chairman from among its membership and the committee chairman then selected people that he thought would be the most knowledgeable in the area to serve with him on the committee. It consisted of three structural engineers, one structural engineer who happens to be a college professor, (Harry Lundgren, whom many of you may know) and George Beckwith, the soils consultant. In addition, anyone who wishes may serve as an advisory consultant to this committee. This simply means that they don't vote but they have a very large say. The subcommittee enters into a series of public meetings, (say once every two weeks, or once a month) until they have the code provision pounded together. That is followed, as a last step, by a public hearing the announcement of which is widely disseminated, and advertised

in the local papers. People are encouraged to come, and quite often we have 50 to 75 or 80 people in that room, depending on the nature of the controversy, if any. Following that public hearing, the subcommittee makes its final decision based upon whatever input they get, and makes the recommendation to the code advisory board which recommends it to the council, because the council must act if it is a code change. We try to get everybody that is interested into the act.

Sears, Veterans Administration:

Did you quote our site survey there?

Hildebrandt:

I said that this was part of the material that was studied by the entire subcommittee as it reached its conclusion.

Sears:

It did show a very minimal acceleration?

Hildebrandt:

Yes; and it is referred to. Incidentally, you may be one who wishes to have the thicker of those two sets because it is referred to in George Beckwith's summary of the soil interaction portion of the background.

Sears:

I don't believe that ground acceleration justified a Zone 2 at all.

Hildebrandt:

Neither do we.

Mayes, University of California, Berkeley:

Your principles of getting nontechnical people involved, seem to me to be very good. I therefore assume, that to get across to the nontechnical citizens you must put their safety with respect to, say, an earthquake in terms of probabilities that

they experience everyday such as getting in and driving a car, because, I find it difficult to believe that they could comprehend a discussion on allowable stresses for masonry unless it was done in terms of something that they would be familiar with.

Hildebrandt:

Well, I think that the observation is correct. There is no way that you can expect a lay person, with no technical background to speak of, to comprehend the kind of jargon that, as structural engineers, we toss around all of the time. However, a building code entity has a slightly different responsibility than a pure engineering group. Our mission is to provide public safety and that is how we try to relate the requirements that appear in codes. We found in this particular case which was the most technologically complex of any code changes that we have encountered in recent years, no serious argument or expression of lack of understanding on the part of the lay public. Now, maybe, had we been finding that we should have been going from Zone 1 to Zone 2 instead of the reverse, essentially, we might have encountered a different kind of response, because, that might have cost people more money. But I think that the guys that served on that committee were well equipped to cope with that, and they provided leadership. They did not just wait for somebody to throw a rock; they provided the leadership that I think any code provision needs.

Mayes:

I'm just interested in how they put the relative probabilities in terms of reference that could be understood by the lay public. They must be a lot better than a lot of other people that I know.

Hildebrandt:

No, I think that this is what the subcommittee had to address itself to. We frankly thought that the very concept of putting the State of Arizona entirely in Zone 2 is a bunch of garbage, to put it kindly. How that conclusion was ever reached I'll never know, but it was; and we do not agree with it and our committee did not agree with it.

Reid, U.S. Air Force:

Almost in every case, (and I think it's quite strongly implied in your case) it just boils down to a question of the bucks. Could you give us any idea of what we are talking about, moneywise, in Phoenix, (that is, percentage wise, what you hope to save by this change, or the penalty that would have been inflicted had you left out the change)?

Hildebrandt:

I would like to be able to answer that in a straightforward way; I can't really. The committee did address itself to that because they felt that they would be asked the question. I've heard numbers ranging all the way from 2-1/2 to 10%. Now, 2-1/2 to 10% of what? Everything is relative. I don't think there is any good way to answer that question in a completely total way.

Reid:

The reason I asked it was because I have been asked it and I haven't had any good answers.

Hildebrandt:

Well, I've had architects tell me, in the past, "I don't know why you structural engineers mess around so much; I can make more of a change in the cost of this building with a change in floor tile than you can by changing your whole structural system."

Reid:

Right.

Hildebrandt:

But that is not to say, that there aren't going to be seventeen irate folks on your back if you demonstrate any unwillingness to try to pull a penny and a half out of that building structurally. The real point of this is, that it is not necessarily a question of bucks totally. Building departments, unfortunately, and building codes in general, wind up getting used as an arena for special interest groups whether they

be people trying to save money or people trying to spend money, whether they be people interested in getting research funds, or whether they be contractors trying to cheat. We're an arena for that kind of thing. The point of all of this, in my judgement, is that this is an improved code provision reached in the right way.

Cranston, British Cement and Concrete Association:

I would like to describe an incident, from British practice, which may help to get this into perspective. You may have heard about the high alumina cement problem in Britain, where quite a number of buildings have had to have remedial treatment. The whole thing started with two buildings actually falling down, including a roof which fell into a swimming pool (empty at the time). As an engineer elected as a councillor I happened to be sitting on the buildings sub-committee and I saw the public reaction to this from both the official side and the public side. The county architect threw the decision as to whether we should close down all of our schools (putting all of the kids onto the streets) while he found out whether there were high alumina cement roofs or not, onto us, the lay committee. The 20-strong committee discussed it rationally, and decided not to close any schools until the presence of high alumina cement concrete was established. In other words we accepted the risk. One of the key arguments was that it was going to be a lot more dangerous to have several thousand kids on the streets getting knocked down by automobiles than to leave them in a classroom with a small risk of the roof falling in. Lay people can discuss this rationally. Incidentally the meeting was open to press and public.

Questioner:

Do you make any distinction with regard to classification of buildings such as hospitals and schools versus general residential construction and so forth?

Hildebrandt:

Yes, that is addressed in this revised code provision, where you have an importance factor. That's what you are talking about, I presume?

Questioner:

Yes.

Hildebrandt:

Yes, we have a variable importance factor. The committee decided in a judgement that it would not make it quite the same in terms of numbers and its effect as, let us say, the UBC does. Now, whether that is right or wrong I wouldn't necessarily have an opinion on; but we do have the difference. We recognize that a hospital is a little bit more important than a Circle-K Market.

Questioner:

Fine, thank you.

* * * *

CONCERNS OF THE NYC HOUSING AUTHORITY IN THE DESIGN OF
MULTIFAMILY MASONRY RESIDENTIAL STRUCTURES

Eric Nadel
Assistant to General Manager for Development
New York City Housing Authority

When Bob first contacted me about participating in this Workshop I was hesitant. As best as I could tell I had no earthquake problems. We settled on that I would come, represent and speak for the large users of masonry and to express some of their problems and needs.

As a frame of reference, let me tell you about the size and complexity of our operation. As of this morning we were the largest owner and operator of multi-family residential property in this country. I must hedge this statement, however, because at the rate the FHA is foreclosing their insured properties, by now they may be the largest.

We now own and operate about 165,000 apartments in over 3,500 buildings ranging from one family homes to thirty story towers. With the exception of the one family homes, many of which are brick, all of our buildings are masonry clad. They are brick curtain walls with concrete block backup, or split block instead of brick as well as load bearing brick and block masonry walls. Almost all of the curtain wall buildings are of a reinforced concrete frame since until now, concrete was more economical than steel. Our buildings contain over 25 million square feet of exterior masonry walls. If my conversion is correct that is over 150 million bricks.

While new construction is now dormant, or perhaps as some have called it, comatose, in our area we are still designing for the future. We hope that future begins after November. Most, if not all of our design work is performed by outside firms under criteria we establish. In addition to our criteria, much of which was established based on 42 years of operating experience, the designers have to comply with the HUD Minimum Property Standards and the New York City Building Code. The designer has to serve three masters and has no easy task.

We may be trying to ignore the problem but we do not think we have any seismic problems that is not covered by the above three criteria. Although the New York City Building Code was revised not long ago, when it comes to life safety, it is still conservative. For example, for an unreinforced load bearing masonry wall of 125 foot height, the lowest 55 feet would be 16 inches wide, the next 55 feet, 12 inches and then 8 inches for the balance. Perhaps requirements such as this make any additional seismic requirements unnecessary. In addition, where seismic risk is low, design for wind load will take care of earthquake load since wind and earthquake are assumed not to occur together.

We do, however, have other problems with masonry. Looking at the problem both from the view of an owner and a contract administrator, we find that the standards have not been revised nor brought up to date. For example, we do not know of any ASTM standard which calls for dimensional stability so that

one can design for a maximum expansion of a brick. In self-defense more and thicker expansion joints are introduced. Nor do we know of an industry standard that establishes the chemical composition of a brick nor what is the firing rate for different chemical compositions. With that standard lacking, how you rationally predict brick behavior we do not know. Indeed, the lack of the above cited standard is part of a problem we now have and which, up to now, has defied solution.

We think that tests of the curtain wall panel, especially its interaction with the frame, would be helpful. Over twenty years ago when we started specifying cavity walls, things were simple. Reinforced concrete frames did not exhibit continual creep nor did brick continually expand. Things were simple.

Both researchers and code writers must keep the economics of the building industry in mind. To introduce design constraints which add to the cost of construction without a realistic payback period will stifle the pace of construction. The other result might be introduction of materials other than masonry which can more easily, that is more economically, adapt to the new requirements.

And lastly, since some of the recommendations that we generate here may find themselves in Federal Standards, please be careful as you apply them. The precision of a rifle shot is preferred to the buckshot pattern of a shotgun. Let's not repeat what we consider a redundancy, the requirement of a sprinkler system in the corridors of a fireproof building.

DISCUSSION

* * * *

Webb, Department of Health, Education, and Welfare:

Did you say that you do comply with HUD's Minimum Property Standards? Is this correct?

Nadel, New York City Housing Authority:

We try as best we can--if we can understand most of it.

Webb:

Thank you.

Nadel:

I think that, for masonry people, it might be interesting to look at one of the standards which requires that, when you have a two-wythe cavity wall, you must parge the interior side of the outer wythe and the outer side of the inner wythe. Unless we can find a mason with a one-inch arm we have great difficulty doing it.

Webb:

What I was really referring to was that the Minimum Property Standards which were recently revised have a reference to BRAB criteria for seismic design that was introduced in that code and those criteria are pretty doggone stringent criteria.

Nadel:

Well, fortunately (or unfortunately, we're not sure which) we haven't been doing much building since the new HUD Minimum Property Standards came out. So, it has given us enough time to start looking at it.

Gensert (Gensert, Peller, Mancini Associates):

You referred to a number of requirements regarding horizontal expansion joints in masonry. Is it possible that that might be a linear change in the column due to creep in concrete or temperature changes?

Nadel:

No question; the problem that you are really facing is that when (I suppose "in the good old days", as some of us today define it) you designed a reinforced concrete frame you knew exactly what was going to happen to it. When you specified masonry, you knew exactly how it was going to behave. As time has been going on, whether manufacturers of cement have been changing their formula, whether concrete people have been cheating on it, or whether masonry people have lost the quality control, you just have a case in which the theory of compensating errors doesn't work. What you find, lately, is that errors keep compounding rather than compensating themselves. And so, you keep introducing more "safety valves" - more horizontal expansion joints, more vertical expansion joints, more ties. You may reach the point where you say "Forget it; let's go to metal curtain wall". At least you don't have to worry about expansion in eight feet of it.

* * * *

REQUIREMENTS OF A SEISMIC RESISTANT
MASONRY CONSTRUCTION CODE

Creighton C. Lederer
Director, Department of Buildings and Safety Engineering
City of Detroit

It is a pleasure for me to join with you here in Boulder, Colorado in this workshop to consider ways of improving Earthquake Resistant Design of Masonry Construction. I would like to start by telling you a few things about Detroit and Michigan as it relates to the regulation and implementation of codes. First, Detroit is the largest major city in the United States using a model code. We use the Building Officials and Code Administrators International (BOCA) Code without seismic design amendments. We are in Earthquake Zone Number 1, which means there is a possibility of some minor damage to buildings due to earthquakes. However, since we have no record of any loss of life or damage to property from an earthquake, Detroit has exempted itself, from earthquake design requirements by virtue of Section 719.1 of our Building Code.

This does not mean, however, that we are not interested in earthquake design. As you know, engineered masonry wall bearing construction is becoming quite popular throughout the country and, in Detroit, it is now approaching the 20-story level. This type of construction is quite brittle when unreinforced and would have difficulty withstanding the whiplash effect of an earthquake. For this reason, we feel minimum reinforcement should be provided. Our policy is to require minimum reinforcement because of our concern for earthquake-like loadings such as wind, earth movement or progressive collapse.

The reinforcement required for these conditions helps guard against the remote possibility of damage due to an earthquake.

We also note that risk maps have been developed which have changed the seismic rating of cities like Charleston, S. Car., Boston, Mass. and Memphis, Tenn., to indicate an increased possibility of earthquake and, consequently, will substantially increase the cost of construction in those areas. We are concerned that these risk maps are fair and that they accurately reflect the best knowledge available on seismic occurrences in the United States.

I would like to stress, in my remarks this morning, what type of seismic regulations I feel we should have in Building Codes in the United States. You should have a summary of my responsibilities with relation to Building Codes to make these points credible. First, I am Director of Detroit's Buildings and Safety Engineering Department with a concern for urban codes. Second, as Commissioner and Vice Chairman of the Michigan Construction Code Commission, I have a responsibility for the state-wide promulgation of codes, carrying them into rural areas that have never had codes before. Third, as a Member of BOCA's Executive Committee and Chairman of the Housing and Property Maintenance Code Committee which is in the process of developing a new model Housing Code, I have a code responsibility for development of model codes which is national in impact. This multi-level responsibility brings me into problems of code development, enforcement, and quality of inspection in urban and rural areas; of City, State, and Federal code promulgation; and, of model and non-model code promulgation. What should a good Seismic-Resistant Code for Masonry Design contain? It occurred to me that, as I reviewed the six major points that I wish to discuss with you this morning, they turned out to be the same as for any important, highly technical and special code item such as high rise-life safety and fire protection, or energy conservation.

This, then, is what I think a good Seismic-resistant Code for Masonry Construction should require:

1. The Code must be usable. Structural Engineers must be able to work with understandable Building Codes that have practical legal force. The code should not be a technical treatise on earthquake resistant design but a concise statement of currently accepted professional practice.
2. It should be a performance code rather than a specification code. The code should not attempt to relieve the individual structural engineer of the need to exercise a high degree of judgment in design details. In general, the code should be more an expression of desired results than a set of instructions on how to attain them.
3. The code should be life safety rather than property safety oriented. Earthquake Resistant Design Codes should not be intended to ensure against damage to structures. It should be assumed that a large earthquake will cause heavy damage, but it should be our intention that it will not cause building collapse with consequential loss of life and injury. Thus, the code should contain implicit economic judgments with a reasonable balance between repair cost and initial cost. Since such judgments will depend very much on local conditions, it should be expected that different countries and different areas in the same country might well have very different codes.

4. Codes are not divine. All codes are in a constant state of development and improvement. As new research knowledge becomes available, as experience from destructive earthquakes accumulates and as various social and economic changes appear it will become necessary to modify the code. A reasonable degree of flexibility in formulation, interpretation, implementation and revision thus becomes very important.
5. The Code must have clout. Experience has demonstrated that codes themselves are of little use unless they are backed by a powerful enforcement agency and a comprehensive inspection service.
6. The Code must ultimately face the retrofit problem. It must be remembered that no matter how effective codes become or how efficient earthquake resistant design can be made, there will be, for a long time, a great number of existing old structures that cannot be brought up to an acceptable standard of strength. In the U.S. alone, I have heard estimates from 350,000 to 400,000 hazardous structures in the Zone 2 and Zone 3 Seismic Zones. In many parts of the world with high population densities and at early stages of economic development, this problem is especially troublesome.

It appears to me, with the little research that I've done, that the state of the art of Seismic Design for Masonry Construction is in a state of disrepair. Therefore, what we do this week is very important. We need new directions and new ideas in research, design and regulation. It is important that we approach this task constructively and with dedication and forcefulness.

What we are about can have a beneficial effect on our communities, our nation and the world. We must, therefore, make a dedicated effort. We cannot afford to do less.

DISCUSSION
* * * *

Webb, Department of Health, Education, and Welfare:

You certainly bring out some very noble points with regard to what a code should be and with regard to performance. I think that there is some pretty heavy experience that would indicate, indeed, that performance is desirable. However, I think, also, that experience would state that you are going to have to write one whale of a volume of textbooks in order to make this performance specification understandable to the profession that must use it. I'm speaking from some experience on that; there are others who might have a difference of opinion. It would be interesting to hear if any of you do have some thoughts on this.

Lederer, City of Detroit:

I think that the history of performance codes has been one of starting with that very important aspect in mind and then running toward specificity. I think, though, that in many areas of the code (and once again, high-rise is a good example) basing as much as we possibly can on performance to begin with and then letting the experience run to that, is probably the best way, in my estimation, to develop a code, if it can be done that way. I recognize that many of us come from practices (I am a professional engineer) for which the problem has different aspects in terms of how to approach it. It's my personal opinion that much of the concern about performance versus the building official specifically telling the engineer what he wants in a design would be removed if we, as engineers, would accept more responsibility for what we are doing. I think that much of the problem that we have is that when there is a problem - when there is trouble - the degrees of responsibility, in many codes, are not spelled out well enough; so the building official finds himself under a great deal of fire along with the engineer. Consequently, that desire for specificity becomes all the greater and it comes from the building official rather than from the engineer himself. I would think that we, as engineers and as architects, would want to encourage that performance aspect so that the innovative ideas we can put into effect would have more ready acceptance by the building official. I think that we, ourselves, are to blame for not assuming more of the responsibility than we do assume; I'm talking as an engineer now.

Yorkdale, Brick Institute of America:

You mentioned early-on in your presentation that you had exempted yourselves in accordance with sections in the BOCA Code, from the Zone 1 area; and then you mentioned that you insist on (or you ask for, at least) a minimum reinforcement in masonry walls. What is your minimum reinforcement and isn't this somewhat of a dual standard?

Lederer:

Yes, it is a dual standard; and I think that one of the reasons why we have a dual standard is because officials, like many of them here, don't find themselves confronted with the earthquake resistant problem on a day to day basis. Our problems are with progressive collapse--are with what happens to a masonry bearing wall if there were an explosion in the basement or if a truck backs into it. Consequently, the reinforcement is required not because of our concern about earthquakes, but because of the other concerns. If we were considering earthquakes alone, we would, as I say, exempt ourselves.

Yorkdale:

What is your minimum requirement; do you recall?

Lederer:

No, I don't recall.

Yorkdale:

Is it up to the two tenths of a percent?

Lederer:

Yes, I believe it is.

* * * *

THE RELATIONSHIP OF MODEL CODES
TO SEISMIC DESIGN

Christ T. Sanidas, Chief Building Official
City of Memphis

(Oral Presentation Only
Followed by Discussion)

DISCUSSION
* * * *

Cranston, British Cement and Concrete Association:

Obviously, performance must be related to the quality of workmanship exercised during construction. In our draft British Code we suggest a materials safety factor of 3.5 for uninspected masonry, and 2.5 where the blocks and mortar are tested during construction. Do you lay down anything in your codes as to what constitutes an adequate check on workmanship, or as to what constitutes adequate inspection?

Sanidas, City of Memphis:

With regard to workmanship, I don't recall anything in our codes. Do you have anything in BOCA regarding workmanship?

Yorkdale, Brick Institute of America:

Each of the masonry design standards has a requirement for inspection of workmanship or else there is a reduction of stresses.

Sanidas:

Right, you mean in the code book; but not for seismic. This is just in our standard code.

Yorkdale:

Well, it's in the standard for masonry design, right.

Sanidas:

Well, I believe it's design inspected by the designer. Am I correct?

Yorkdale:

Correct, or his representative.

Sanidas:

But as far as the code goes, specifically, it does not allow the building official to comment on workmanship per se. They have been very careful to take that out of our code in the last few years.

Redmond, National Concrete Masonry Association:

This is just a comment: I wanted to point out that (while, of course, the housing will be predominantly frame) we just held a national symposium on low cost concrete masonry housing in Memphis for about 300 builders and they were quite interested in it. We did tour about four subdivisions having these fiber reinforced surface bonded concrete block masonry homes that are being built in your area.

Sanidas:

In this on the foundation.

Redmond:

No, I'm talking about the full home. Preco Industries is heavily involved in building them.

Sears, Veterans Administration:

I hate to see you people down in Memphis downgrade this seismic problem; we haven't. We have a hospital down there that is costing us about twelve million bucks to rehabilitate. According to our seismic consultants, Woodward and Lundgren, you're going to get a basic acceleration of about .25 and that's worse than some spots in California. I know that you've had your plague and your fire and you don't want any earthquake, but....

Sanidas:

Actually, all of the federal buildings that are built in the Memphis area and also, I believe, out in Millington, (our naval base is outside the city limits of Memphis) are using, and have been using Seismic Zone 3 design. Only federal buildings have been using

it, though. We are, presently, for Shelby county, proposing a 30-million dollar criminal complex within the city limits of Memphis and the designer is designing it for basically Seismic Zone 3 design; basically that is. Now, I don't know what the word "basically" means yet. That's also the case that we have with one of our new hospitals: basically, it meets the Seismic Zone 3 requirements, but, there again, because we don't have these requirements, we don't know for sure.

Sears:

You'll know for sure when it gets there.

Questioner:

Aren't you near the New Madrid fault?

Sanidas:

Right, we're right there.

Questioner:

Within the last couple of years, they've had a pretty good size earthquake.

Sanidas:

Yes, we've had two slight tremors in, say, the last four or five years; we had some cracks and some windows broken, but this will not convince a lot of people. Believe it or not, it's not the people on the street, the general public, that I've been talking to, but some of the engineers, and they just feel that it's economically unfeasible to go into seismic requirements; I can't understand it. Of course, the fact that the professionals are not really for it is something that surprises me personally. So, we're kind of going out on a limb by ourselves, in what we are doing.

Cole, Structural Engineers Association of California:

I'm from Sacramento and I would like to make a comment about your statement that nothing can be as bad as California. We say, in Sacramento, that we can't possibly be as bad as San Francisco and Los Angeles.

Sanidas:

I'm sorry; I keep forgetting they have a North and South out there too!

W. Werner, Department of Housing and Urban Development:

Since HUD is receiving such attention at this conference, I thought I would discuss two more areas that HUD is involved in. This question of performance codes has come up a couple of times and I would like to throw this out for the Working Group that's involved in performance codes. The new Minimum Property Standards are about as performance oriented as FHA felt that they could go at the current state of the art. There is a mix of performance and some prescriptive requirements. However we do have a fourth volume to the three-volume MPS set which is what we refer to as the "Manual of Acceptable Practice". We see, as a philosophy, that you can never write a pure performance code; that you are going to have to have something to go along with it. HUD has deemed to call it the "Manual of Acceptable Practice: and it is intended for use when that builder that Dr. Crist is talking about walks in and says, "I don't know anything about shear walls". He picks up the "Manual of Acceptable Practice" and it shows him all the nailing schedules and everything he needs to know to build his house. That is an approach to performance.

We have also recently signed a research contract with Severud, Gruzen and Turner, of New York, to do a study as Mr. Sanidas has suggested. What we are trying to do is to take a prototypical building, (one, if possible; two, if we have to) - a basically typical rectangular residential apartment building layout - and see if we can come up with some credible figures on how much it costs to build, going from Zone 1 to Zone 2 to Zone 3 using the requirements of the local code, the Minimum Property Standards, using UBC '73, and in two cities, UBC '76. That project has just begun and will be completed in June 1977. We're not looking for first cost; we're not looking at whether, say, steel is cheaper than masonry or anything like this. We're looking for the differential when given: I'm going to build a building in a Zone 2 area; and somebody comes in and says, "You've got to build that building to a Zone 3 requirement. What's the delta going to cost"? We're doing this because we get the same cost impact data at HUD: from 2% to 100%. Of what, we don't know.

Lederer, City of Detroit:

Chris, [Sanidas] I just wondered if you would elaborate a little bit on it. I think we both try to approach the same problem. It's just that we're in out-state Michigan where

Sanidas:

Well, this is where we're using the model code groups; we have to. This is where your model code group, whether its BOCA, Southern, or ICBO, is called upon to give out information. This is where we're getting the model code groups involved. It's just recently that we've started putting out certification of inspectors which is not a local but a national thing. This is where your three code groups are getting together. You're having a lot of this that's going to have to be worked out by the model code groups. I look to them whenever I have a problem. I'm sure that whenever you have a problem you get on your WATS line to BOCA; I get on my WATS line to Standard; and we say, "We have a problem". I think what we'll end up doing is maybe having the three code groups come up with something like this because, locally, we have nothing. There's no one that's going to do this type of thing for nothing of course. For example we've got this research project (I forget what it cost us - forty, fifty thousand dollars) as to whether or not we're in a seismic risk area. The reports are up there on the shelf gathering dust for two years. It was a good thing going; it hit the papers for a while; and then it stopped. That's it; lost all interest in it. Now of course, we're fortunate that we have a newspaper, locally, that has put several very good articles in their paper regarding seismic problems and that we're on the New Madrid fault and trying to explain it. But we don't want to scare the citizenship; that's the worst thing in the world that could happen - overreaction. So, you try to play these things down. You don't try to take advantage of them when you have a little tremor and say, "Look, here it is; here's a little tremor; we're going to hit this thing hard now". Well, we don't want to do that because then you have overreaction; and as a building official you know that sometimes overreaction is worse than no reaction. If we get too much of a reaction we get something we can't enforce and then we're left holding the bag. So, what you're talking about is what we'd like to have - pamphlets and any information and things like this; not only to the building officials but to the builders, the architects and the engineers. We have a lot of good engineers in the Memphis

area that design work in California, don't get me wrong, but then we have some that don't; and you know, I don't want to knock any engineers, but let's face it, when I graduated from college in engineering, "Throw in your safety factor for seismic" was the extent of it. I mean, your colleges don't put it out either. We're talking about those of us that are in the profession now. What about the guys that are coming up out of school? This needs to be put into the schools also. You have your structural engineers and your soil engineers; they're getting the same education, I guess, that I got. Seismic design was something that really was just passed over, lipped like. Maybe that's where we need some help, too, because there are a lot of young fellows coming out of college right now. I know that we've got a lot of young fellows here (they're young compared to my age) that are sharp in this stuff but that's because they're on the West Coast. That's where all of this work is being done. There's not so much of it on the East Coast or in your area or in my area. So, I think that maybe we need to bring some of that knowledge into our colleges too, not just for us, but the future generation coming up.

Sears, Veterans Administration:

It seems as though the basic problem you're talking about is this. The structural engineer gets about three quarters of one percent of the total job cost; is that right? He has to operate within that cost; this is what we find at VA. If you tag on a seismic analysis and design within that three quarters of one percent it comes out of his pocket, doesn't it?

Sanidas:

I would assume so. See, that's where you hit economics; it's just like it is with the building department. If we adopt seismic we're going to have to enforce it.

Reid, U.S. Air Force:

I'll just make a fast comment on that last comment. As you know, we're limited in AE design fees to six percent of the estimated cost of construction; but that does not include other things that are necessary for the design, such as topographic surveys, and water surveys. We have interpreted this in many cases as being for seismic analysis.

SOME RESEARCH NEEDS OF EARTHQUAKE-RESISTANT MASONRY

James E. Amrhein
Director of Engineering
Masonry Institute of America

Abstract

This paper outlines in general terms many specific needs of the masonry industry to obtain information, establish performance parameters, improve the final product and develop design criteria. It points up the many areas where information is lacking as related to dynamic seismic performance and reliability.

Key Words: Anchor bolts; bond; damping; ductility; earthquake resistance; energy absorption; modulus of elasticity; partial reinforcing; risk; shear modulus; testing; ultimate strength.

The Masonry Institute of America is a trade organization which is supported by the mason contractors of Los Angeles County. This paper presents a few ideas that are important to this group. The mason contractors, along with architects, engineers, owners, and building officials, want earthquake-safe buildings. They are concerned with safety and structural performance because the failure of a masonry building in an earthquake is a tragic event for people and the industry.

The Masonry Institute of America and similar organizations actively and continually support research programs in many ways. They furnish materials, build specimens, contribute money, and provide technical assistance and advice to further the knowledge of masonry.

There are numerous areas of concern, and the following lists a few.

1. The first concern is to keep relatively simple the code requirements and the method of masonry design. Design procedures that are so complex and restrictive that one has to be a genius to use them are not wanted. Criticism has been leveled at the ACI 318 Concrete Building Code for being too difficult to use and the ACI committee has been working to simplify it. The input of loads, particularly seismic loads, are unknown and very variable, therefore, extreme precision and complex involved engineering is of questionable value and should be minimized.

2. There is a need for a comprehensive ultimate strength method, or as I call it, Capacity Design. We need to know the resisting capacity of masonry structures to all forces, such as seismic, shear, flexural, etc. There must be realistic load factors and factors of safety. Right now the factors of safety vary from less than two to perhaps ten, depending on the stress or load considered. These should be brought more into compatible agreement.

3. It is suggested that there be developed principles for structural backup systems as in aero-space design. Why not design buildings with multiple paths of failure and with redundant systems. This need not be difficult, for it can be as simple as coupled shear walls, similar to the Bank of America building which performed so well in the Managua earthquake of December, 1972.

4. There is a need to know the parameters for energy absorption, ductility and damping both in the elastic and inelastic range and to be able to apply these to the design of masonry buildings.

5. What is the stress and strain relationship between materials for individual components and assemblies of these components for both static and dynamic conditions? What if high strength grout is used with low strength block, or high strength brick used with low strength mortar and grout?

6. What is the actual modulus of elasticity? Shear modulus? Poissons ratio? What is the influence of the a/d aspect ratio on the performance of walls? What is the effect of reinforcing? Can masonry systems be effectively prestressed to improve their seismic resistance?

7. Let's be realistic in laboratory and job tests and material requirements. Mortar tests as per ASTM are fine for testing the cement, but they do not provide information as to the performance or influence of mortar in a structural wall. Prisms are an indicator of compressive strength, but they must be representative of the actual masonry wall strengths. Is compression strength the gauge by which we should measure the capability of masonry to resist earthquake forces? Perhaps a splitting tensile test, a bond shear test or a tension test would be more indicative of the qualities required for seismic-resistant masonry walls.

8. The use of so-called partially reinforced walls as a viable system to be used in some areas must be developed further. This can be particularly useful in one-story residential housing.

9. There have been excellent results obtained by using perforated plates in the mortar joints to provide confinement and improve ductility and performance. More research is needed to define areas of application for this method.

10. There is a need for uniformity of masonry materials and workmanship. Quality control is a necessary feature for any construction material and system that seeks confidence and credibility.

11. There is a need to improve bond strength, both bond of mortar to the masonry unit and bond of grout to the masonry unit, so that the masonry wall is a homogeneous element.

12. What are the minimum and maximum amounts and sizes of steel that are functional? How about bundling bars as in concrete; is this effective for masonry?

13. Information must be obtained on the capacity of anchor bolts, joist anchors and connections, and this must include all types of floor and roof diaphragm systems for both static and dynamic conditions.

14. Structural engineers have been espousing the benefits of flexible frames as the way to build to resist earthquakes, but then these frames are becoming stiffer and stiffer. I have held that shear walls or stiff buildings are the best way to resist earthquakes with minimal damage. I would like to see credit given to shear wall buildings in the form of lower earthquake insurance premiums, and the shear wall given a preferred status in the design and construction of buildings. Stiff, infilled frame buildings perform better than flexible frame structures, as shown in tests conducted at the University of California, Berkeley.

15. There is a need for a viable method of equating risk, life of structure, seismicity and probability of event to provide a design parameter that is realistic. This may have to be arrived at with the aid of the seismologist, geologist, engineer, owner, and building officials. We need a minimum requirement for personal public safety,

but how much more should be provided either voluntarily or mandatorily?

16. We need to keep an open mind to all methods of construction and materials so that the engineer and masonry contractor have the freedom of innovation and invention. Accordingly, height limits or size restrictions placed on masonry buildings and walls are in serious question.

17. There is a desperate need for a communication vehicle that will keep all of us informed on what has been done, what is being done, and what must be done. We need an "American Concrete Institute," for masonry, say, an "American Masonry Institute" or a "Masonry Research Council." With an organization such as this, all interested people would keep informed and be able to help extend the knowledge of masonry. Such an organization would be of tremendous benefit for literature surveys and help disseminate masonry knowledge.

These are just a few suggestions concerning the interests of the California masonry contractor as related to earthquake-resistant masonry design and construction.

SUGGESTED RESEARCHABLE ITEMS
RELATING TO MASONRY CONSTRUCTION

J. F. Meehan
Principal Structural Engineer, Research Director
Structural Safety Section
Office of the State Architect
State of California

ABSTRACT

The purpose of this paper is to present a brief overview of needs believed necessary to improve the resistance of masonry construction to earthquake forces.

KEY WORDS

Allowable bolt loads, end distance, edge distance and spacing; high lift grouting; veneer anchorage; face shells, reinforcing splices; drift; shotcrete, surface wave instrumentation.

APPLIED RESEARCH

The need for additional research on several items is suggested here which should lead to a better understanding, proper design, and improved construction techniques, all of which will lead to improved performance of masonry structures during violent earthquake motion. The suggestions made are a result of observation of the performance of actual buildings subjected to such loads, and the observation of in-the-field construction and quality control of buildings.

BOLT DESIGN AND INSTALLATION CRITERIA

There are innumerable field examples (1,2) showing that bolts cast in masonry construction perform rather poorly during earthquakes. Examples are shown in Figures 1 and 2. There are little basic data available in the literature relative to the strength and displacement characteristics and the installation techniques required to properly design and construct bolted connections in masonry. Briefly, information is needed on bolts in various types and strengths of commonly used masonry construction; the effect of bolt size, and embedment; the influence of the bolt head; the minimum edge distance of grout and masonry, edge distance and spacing

for lateral load transfer; the depth requirements for withdrawal loads; the performance of bolts placed on the top of the wall, column or pilaster, compared to placement in the face of the wall or pilaster; influence of installing bolts within reinforcement ties, reinforcing bar hook bends, hair pins or other means; the influence of reinforcing within the wall particularly at the corners; and the influence of the effect of thickness and stiffness of material delivering the load to the bolt, i.e., the comparison of a thick wood plate and a thin steel plate delivering load to the bolt.

HIGH LIFT GROUTING

To obtain competent reinforced grouted masonry construction the grout must be properly placed. In the high-lift grouting technique this requires the proper slump of the grout, proper placement of the grout including depth of layer and consolidation, and especially the proper reconsolidation of the grout. Examples are shown in Figures 3 and 4. Variables for proper placement are ambient temperature, relative humidity, thickness of grout space, and mix of the grout including any admixtures. All of these variables should be explored and the limits and controls should be established. The high lift grouting construction techniques should be encouraged.

MASONRY VENEER SUPPORT AND ANCHORAGE

Masonry veneer such as that shown in Figure 5, is frequently shaken from walls during earthquakes (3). Codes contain requirements for veneer anchorage yet there has been little or no research on this problem to determine exactly how masonry veneer should be constructed and the influence of the various parameters involved.

The anchorage resistance for inward, outward and inplane loads of walls supporting masonry veneer as well as mortar joint reinforcing must be investigated. Some codes will allow inplane load resistance in the veneer, others will not. The required stiffness and materials of construction of the wall for loads acting perpendicular to the wall supporting the masonry must also be determined. The influence of shrinkage of wood framing providing lateral support should also be considered in the investigation.

VERTICAL REINFORCING SPLICES

Heavy cracking and thus failure of corners or ends of masonry shear walls is frequently observed in earthquakes (4). An example is shown in Figure 6. There is a strong possibility that such damage results from lack of proper perimeter reinforcing splices and grout coverage of the bars. Such cracking or failure is the start of serious failure of shear walls. It is a common belief

that the perimeter reinforcing must be adequate to prevent the initial formation of cracks through the wall because such cracks greatly reduce the shear strength of the remaining length of wall. Current codes require the perimeter bars of concrete shear walls to be spliced within confining type reinforcement. Such construction should be investigated for masonry construction. Also the minimum amount of coverage of grout and the influence of the compressive strength and composition, i.e. size of aggregate of the grout must be considered.

CONCRETE BLOCK FACE SHELLS

It is common to see the face shells of concrete block fill cell construction fail and fall from walls from earthquake motion, (4) i.e. the face shells are not properly bonded to the grout core as shown in Figure 7. Face shells also fall off when cores are cut through the walls as required by some codes to determine workmanship and quality. The use of an expansive admixture tends to reduce this type of failure in cores and is highly recommended by several code enforcing agencies. Some means, perhaps through the use of admixtures and improved construction techniques, should be developed to alleviate this hazard to the public and strength reducing condition.

When quality and workmanship cores are taken and the face shells fall off, the engineer must justify the strength of the wall for loads acting perpendicular in one of two ways. One assumption is by considering only the grout core and the other by assuming the face shells act to resist the compressive bending stress and the "horizontal shear" due to the bending stress is transferred through the web of the block to the reinforcing through the sides of the webs of the block, this latter assumption is to the advantage of the analysis and is the one commonly proposed. This method of analysis should be justified by test.

DIAPHRAGM CORNERS

It has been very obvious that the diaphragm areas within the corners of various types of diaphragms lead to upward buckling failure of the diaphragm material and the wall anchorage (2). Several cases were observed in 1971 San Fernando Earthquake damage. One is shown in Figure 8. This same "local" condition is observed in larger scale diaphragm tests and was repeatedly shown in many commercial buildings. In almost all large diaphragm tests the corner areas of the diaphragm will bulge upward

from the framing and thus initiate the diaphragm failure. In some tests the corner framing also uplifts. There also appears to be an influence from the continuous corner stiffness of the masonry or other type wall construction. It is suggested that the influence of the rotational stiffness of the walls and of the intersecting walls be investigated and an evaluation relating to the stiffness of the roof diaphragm be thoroughly investigated.

VERTICAL CRACKS IN WALLS

Although vertical cracks do not necessarily form as a result of earthquake motion, there has been a rather large number of instances where vertical cracks have formed in concrete block solid grouted walls shortly after the wall has been constructed. Provided there is proper reinforcing both horizontally and vertically within the walls, there is little concern for the structural strength as evidenced by analysis of this problem. The owners, however, do not feel that the walls of their new buildings should permit free water infiltration through the walls into the building.

Possible reasons for such cracking should be investigated. It may be due to shrinkage of the grout, low tension strength of the block, moisture shrinkage characteristics of the block, moisture content of the block at the time of construction and water content of the grout.

DRIFT

Improper consideration of drift leads to excessive property damage and public hazard. This results in serious structural architectural, mechanical and electrical damage. It is critical to the proper performance of masonry structures, as well as all forms of construction, that dependable analytical means be provided to determine the actual expected drift displacement to prevent structural and non-structural damage from seismic and wind loading. Methods of analysis of drift of masonry construction must be developed.

GUNITE RETROFIT (RECONSTRUCTION)

The gunite or shotcrete rehabilitation or retrofit technique of existing masonry construction should be investigated and evaluated to provide design and construction procedures to properly resist lateral loads. This technique of construction has been employed for many years in rehabilitating California schools, however, no positive means of justifying the design assumptions and analysis has been presented

to the design sector and regulatory agencies. Several school buildings constructed prior to 1933 and rehabilitated under the provisions of Section T21-2422 "Use of Existing Masonry" in Title 21, California Administrative Code, (See Appendix A) were exposed to the 1971 San Fernando Earthquake and performed reasonably well. Unreinforced masonry walls were gunited and reinforced to meet these provisions and no cracks or failures were noted in these walls after the quake. Unreinforced masonry wall school buildings which had not yet been rehabilitated, but located on the same site did suffer rather extensive damage and were abandoned and later demolished after the quake.

This rehabilitation or retrofit technique is being used more frequently by many groups throughout the United States and will be used by a great number in the future; therefore, it deserves much more investigation to establish allowable design and recommended construction techniques.

SURFACE WAVE EARTHQUAKE

Although not solely a "masonry" problem it is suggested that firm efforts be made to study short length "surface" waves frequently reported by observers during earthquakes. Such waves are always reported by the local observer but no scientific or applied engineering techniques are available to shed light on this problem. Short surface waves can better explain some of the great damage to adobe and other masonry construction. For example, two different priests at two different school sites in Chimbote, (5) Peru in 1970 reported to this author that they saw surface waves six to twelve feet between crests and six to twelve inches in height progress rapidly across their school yards during the earthquake. At one site the soil was almost pure sand located several hundreds of feet above the surface of the ocean and was without any visible indication of water. Here the wave lengths were about twelve feet between crests. At the other school site the surface water was only about three feet below the surface of the sandy soil and the waves were shorter.

It is suggested that arrays of accelerometers be variably spaced starting at say three feet on centers and progressing to one hundred feet on centers, tied with a common timing device and installed on various soil conditions.



Figure 1 If the vertical trim bars were bent horizontally under beam or if a horizontal hairpin bar were placed around the bolts this damage may be alleviated.



Figure 2 Horizontal ties around the bolts may alleviate this damage and increase their strength.



Figure 3 Section of improperly consolidated high lift reinforced grouted brick masonry wall. Wall has been rotated on its side and saw cut for visual purposes. Note the separations within the grout space.



Figure 4 Section of properly placed high lift reinforced grouted brick masonry wall and foundation.



Figure 5 Masonry veneer was shaken from this concrete block wall.



Figure 6 Studies of proper perimeter bar splices in masonry walls should be made.



Figure 7 Investigations are needed to improve bonding the face shells of concrete block to the grout core. Note the horizontal pour joint in the grout cores.



Figure 8 The influence of the corners of masonry walls on the performance of horizontal diaphragms should be examined.

REFERENCES

1. Meehan, J.F. "Earthquake Effects on School Buildings" The Prince William Sound, Alaska, Earthquake of 1964 and Aftershocks, Volume II Part A, U. S. Department of Commerce pp. 219-243.
2. Earthquake Engineering Research Institute "Damage to the San Fernando Industrial Tract" The San Fernando California Earthquake of February 9, 1971 Geological Survey Professional Paper 733, U. S. Department of Interior pp. 202.
3. Meehan, J.F. "Reconnaissance Report of the Veracruz, Mexico, Earthquake of August 28, 1973" Bulletin of the Seismological Society of America Volume 64 No. 6 December 1974 pp. 2011-2025.
4. Meehan, J.F. "Public School Buildings" San Fernando, California Earthquake of February 9, 1971 Volume 1 Part B, U.S. Department of Commerce pp. 667-684.
5. Stratta, J. L.; Berg, G. V.; Enkeboll, W.; Meehan, J.F.; McClure, F. E. "Preliminary Report Peru Earthquake of May 31, 1970" Earthquake Engineering Research Institute 1970 pp. 32.

APPENDIX A

T21-2422. Use of Existing Masonry. (a) General. Existing masonry which does not meet the requirements for reinforced grouted masonry shall not be used for structural purposes.

(b) Method of Repair. Gunite or concrete structural systems may be used to strengthen existing masonry which does not comply with the requirements for reinforced grouted masonry. Such masonry shall be relieved of stress by the gunite or concrete, except that it may be assumed to carry its own weight vertically.

(c) Gunite or Concrete Method of Strengthening.

(1) Ribs or minor columns of gunite or concrete may be incorporated into existing masonry to support vertical loads and lateral forces normal to the wall. The width of the chases cut into the masonry to form the ribs shall be at least $1\frac{1}{2}$ times the depth. Concrete or gunite membranes between the ribs may be used to resist shear in the plane of the walls due to lateral loads. The thickness of the membrane shall be not less than one twenty-fourth of the clear distance between the ribs or minor columns and in any case not less than that required by Chapter 26.

(2) A membrane will be required where ribs or minor columns are more than 5 feet apart in the clear. Where less than 5 feet apart in the clear a membrane will be required unless the ribs extend to the far tier of masonry.

(3) There shall be a rib or minor column within at least two feet of each vertical edge of each opening in the wall where there is a membrane, but where there is no membrane there shall be a rib or minor column at each vertical edge of each opening.

(4) If a gunite or concrete membrane is placed against only one side of a unit masonry wall, the gunite or concrete membrane shall be in contact with the far tier of the unit masonry at not less than one point in any rectangle 4 feet wide and 3 feet high. The area of such contact shall be not less than 64 square inches. Exception I: If continuous ribs or minor columns are provided not more than five feet apart which extend through to the far tier, intermediate contact points may be omitted.

Exception II: Where the membrane is in contact with header courses that extend to the far surface, where such header courses are spaced not farther apart than every sixth course and headers are spaced not more than 12 inches apart, intermediate contact points may be omitted.

(5) Where such walls are in contact with reinforced concrete or gunite columns, beams, or walls, the concrete or gunite portion of such walls shall either be constructed integrally with the abutting columns, beams or walls, or key-ways shall be provided to resist the design forces.

(6) Surfaces against which gunite is to be deposited shall be prepared in accordance with Section T21-2621(h).

Surfaces against which concrete membranes are to be placed shall be prepared as prescribed for gunite, and in addition joints at the header courses in brickwork shall be raked back $\frac{1}{2}$ inch. The height of each pour and of each lift of forms shall not exceed 9 times the thickness of the membrane.

(7) Ribs supported laterally by gunite membranes shall be reinforced with not less than two #5 bars. Other ribs shall be reinforced with a minimum of four #5 bars. Ribs shall have #3 ties at 9 inches on centers and shall have one #6 dowel, top and bottom, where ribs frame into the existing concrete construction. The membrane shall be reinforced with not less than #3 bars 18 inches on center each way. Dowels shall be provided to existing concrete construction where shear is transferred. Dowels shall be equivalent in area to the reinforcing and spaced not more than 36 inches on center.

DISCUSSION

* * * *

Amrhein, Masonry Institute of America:

Jack, I'd like to ask, how many people lost their lives at Juvenile Hall [Los Angeles County]?

Meehan, State of California:

I don't believe there were any lives lost there.

Amrhein:

So, therefore, the structures performed at least to that degree. Then we ask: What was the level of earthquake, and what level were the structures designed for? How many structures failed? How many masonry failures? How many failures where the masonry face shells fell off? I ask, "Doesn't everything eventually fail?" Perhaps this was the earthquake that caused that kind of failure (of face shells spalling) but yet, in my opinion, that school performed well because nobody lost his life. So, to what level are we going to ensure no damage to the structure? Now, I go along with you, we have to keep improving (I'm not trying to say we don't) and every time we get a problem let's try to improve on it. But, I think that somewhere along the line we should ask, when does it become economically limiting?

Meehan:

Of course, I can't answer that question. It is true that not very many people were killed in San Fernando. The time of day has great influence on the death toll. On the other hand, there was a great deal of repair work. Are you, the engineer - are you, the architect, - are you, the public - are you satisfied with that performance? Maybe that time nothing happened from that particular earthquake, but that does not assure that damage will not occur in the next one. So, you can't put all of your judgement on one side; you must look at both sides. I think that much can be done in earthquake resistant design by proper layout. You can save a lot of money in an earthquake resistant design by proper layout. There are studied cases, in which the increase in cost for earthquake resistance is zero with the proper design, and which meet the code.

Sear, Veterans Administration:

You mentioned deflections. It seems like the VA Code is one of the few that really controls deflections, but we have a serious problem. For steel, you know the modulus of elasticity (pretty close); for reinforced concrete, well, you're a little farther away, but still get deflections. I mentioned earlier that when we went from the diamond specimens to the circular specimens for our strength tests we dropped our cost, but we also dropped one other piece of information off that was kind of valuable. We could get the modulus of elasticity of the assemblage out of those diamond one and a half foot-square specimens; we can't do that with the circular specimens. In order to get deflections, you have to know something about the stiffness of a wall; and in order to know something about the stiffness of the wall, of course, you have to know the modulus of elasticity or some property like that. That, to me, is an area that would really be interesting - for us, anyway, probably for you too, - because you really want to control deflections I'm sure.

Meehan:

I agree.

Questioner:

(Directed unrecorded question to Hegemier.)

Hegemier, University of California, San Diego:

Let's see, you had several questions: Are we measuring deflections? The answer is yes.

Questioner:

Do you have a way of evaluating that and putting it into use? You're measuring now; do you have means of using that so we can . . .

Hegemier:

Well, one thing at a time; we're conducting tests on these materials. We're in the process of measuring the moduli of the materials; and in the process of coming up with the moduli, you are, of course, measuring deformations. Now there are several problems: first

of all, these materials are nonlinear; so you have to make some decision as to what you mean by a modulus. But, yes, we're measuring deformations; and, hopefully, in the near future, we'll be able to provide useful design information along these lines. Moduli vary, by the way, depending on the size of the specimen. There's a scale effect that we found (I'm talking now about concrete masonry) that is considerable, involved here. Also, it's not isotropic. So, some of these things are rather complex. To make the results simple, as some individuals have indicated they would like, may take some time; because it's going to take time to do the testing, analyze the data, and then decide how in the world to put it into form that can be used on a design basis being conservative, yet, not overly conservative.

Hegemier:

I have a question with respect to consolidation. Your cuts were very nice on your brick specimens. You evidently had several different high lifts; and then you came down, evidently, in height of lift. There was one there where you had good consolidation; what size lift was that?

Meehan:

Brick grout consolidation?

Hegemier:

Yes, this was brick. You showed cuts of brick specimens. Then you showed shrinkage cracks and bridging of the grout; and you said that there was some correlation between consolidation and these cracks. There was one slide in which you indicated (it was very clear) that there was good consolidation, and there were no cracks. What case was that? Was that a two-foot lift and did you consolidate?

Meehan:

The recommended procedure calls for using a four-foot height of lift.

Hegemier:

Was it vibrated?

Meehan:

First of all, you get a good clean joint and then, you pour your four-foot lift. If you have a long pour you shouldn't have a thing that's over around 25 feet or so, so that you can get control of that when you pour the grout. It's going to run out, because it's very, very soupy. So you pour the four feet and consolidate it with the vibrator and then you wait. It ended up as we found in the San Francisco Bay area, that there's around a twenty- to thirty-minute wait before you should reconsolidate it. If you haven't had reconsolidation or haven't used high lift, you're going to have to work with it a little. You can do this by following the recommended procedures; then cut some cores; see how that job turns out and you'll learn what to do on the next one.

But basically, you pour the four-foot lift; then you pour the second four feet twenty minutes or a half hour later, but you run the vibrator down into the first pour, thus reconsolidating the first pour. Then you pour your third lift on top of the second and reconsolidate each lift as you progress up the wall. Then, even as you top it off, you must also reconsolidate the top layer.

Mayes, University of California, Berkeley:

I'd just like to add to what Gill [Hegemier] said, Jack. With respect to the test that we were running, before we got any cracks in the wall whatsoever, we had a twenty-five percent reduction in the stiffness of the specimen. I realize that what we ultimately have to come up with is some simplified sort of criteria, but I think that what the design profession has to realize is that we're dealing with an incredibly complicated material and that this is not going to be easy. The research results that you use with the smoothing process--that we'll obviously have to go on taking and applying for design purposes--are going to have a pretty broad standard deviation. We're now looking at these problems; there are a lot of complications involved. We have a long way before we can extend the results to a theory.

Meehan:

That's good, I'm glad to hear that you are working on this problem. I think you also have to coordinate drift with the deflection properties of other materials--plaster, glass, any of the other building materials.

A VIEW ON SOME PREREQUISITES FOR IMPROVED
EARTHQUAKE RESISTANT MASONRY CONSTRUCTION

Michael E. Werner
Technical Director
Building Officials and Code Administrators International

In order to understand my concerns for earthquake resistant masonry construction as it relates to the BOCA membership, it becomes necessary to render some basic factors which I believe have contributed to a general resistance to, or passive consideration of, earthquake problems.

There exist two dominant risk maps or seismic consideration maps generally used in the United States; one being a map as published within the BOCA Basic Building Code/1975 (copy attached) and based on imposing risk zones over damaging earthquake occurrences throughout the United States as compiled by the National Ocean Survey with risk zones determined by the ANSI Committee A58. This map is generally typical of use in the midwest and various northeast portions of the United States; the other seismic zone map (copy attached) reflects risks in a similar manner, and is made available by ICBO and the Structural Engineers Association of California as published through the Seismological Committee of the Construction Engineers of California, this second map being more generally used for construction considerations on the west coast, military construction and Department of Housing and Urban Development related construction. A quick review of these seismic maps gives evidence of considerable variation in opinion as to risks or level of need for seismic design criteria. It is my belief that this very basic problem reinforces a variety of relaxed decision making processes at the local level; and when coupled with a general lack of understanding of, or technical ability to cope with, seismic problems, it will continue to be utilized as justification in making very liberal decisions as they

relate to seismic design parameters or risks. This problem is compounded by constant local and regional considerations related to political or economic competitiveness of one area or region or state versus another area, region or state.

All the above considerations are further complicated by current movements in older central city areas toward rehabilitation of existing nonconforming structures, a movement which I believe would receive a great economic burden if seismic considerations became generally applicable upon rehabilitation. Such requirements are generally indicated in most building codes and standards relative to rehabilitation. This would be particularly critical as it relates to masonry construction because such construction is typical of most older center core urban areas.

The general problem becomes extremely taxing as it relates to risk zones. In terms of risk zones or levels of risk, I personally question exactly what, in the amount of life loss or injury risk is involved, particularly at the low and moderate risk zones.

There exists a general consensus among jurisdictions in the midwest, that Zone 1, or minor zone criteria are generally over-ridden by wind design criteria. This is either a correct or incorrect assumption with some prequalifications and needs clarification.

In view of the above, I would hope for some general workshop input into the following areas:

1. Development of or research leading toward a clear and concise statement of risks as well as basis of risks, i.e., property damage dominant, personal safety dominant.

2. Development of or research leading to the development of a direct statement of risk beyond the level determined in overall risk statements, i.e., design for minor occurrences and probability of having a moderate or major occurrence and consequences of same.
3. Development of or research leading toward development of a statement of economic impact at various levels of design for various materials of design.
4. Development of or research toward development of key design and inspection considerations for masonry structures, with a hopeful end product of simplified design formulations and pictorial inspection tests and indicators. (Inspection problem may demand professional field certification.)
5. Development or research toward development of key considerations in evaluating old, nonconforming structures as affected by vertical or horizontal additions.
6. Development or research toward development of key considerations as related to pre- and post-earthquake evaluations of old, nonconforming structures in terms of damage potential or evaluation.
7. Development or research leading toward development of critical choice seismic considerations as they relate to general rehabilitation of existing buildings. Explorations of half-way measures which would be effective, for example, if confronted with a \$200,000 problem, is there a reasonable \$100,000 alternate to accommodate for major considerations of seismic danger in existing old, nonconforming structures.

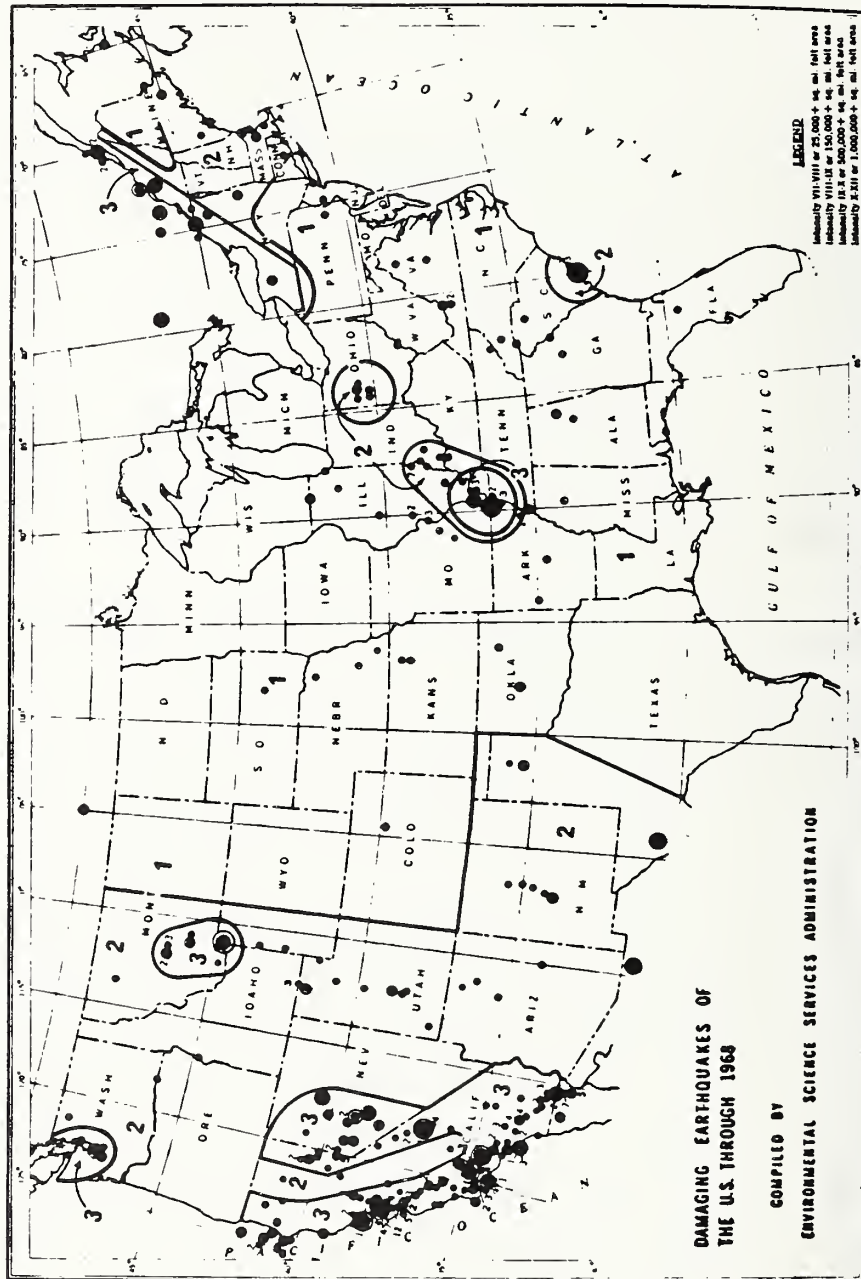

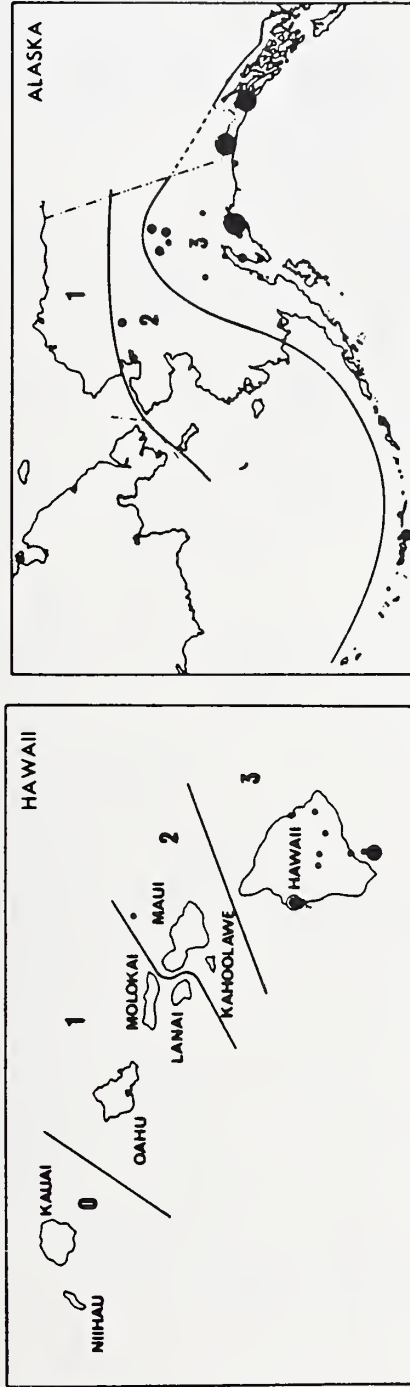

Figure L-101.1
DAMAGING EARTHQUAKES IN THE UNITED STATES THROUGH 1968

Note a. Maps of the three separate areas of the United States which indicated earthquake risk zones to supplement coefficient Z. This zoning was superimposed on maps showing the damaging earthquakes of the United States through 1968 that were compiled and supplied by the National Ocean Survey. The earthquake risk zones were determined by the ANSI Committee A58.

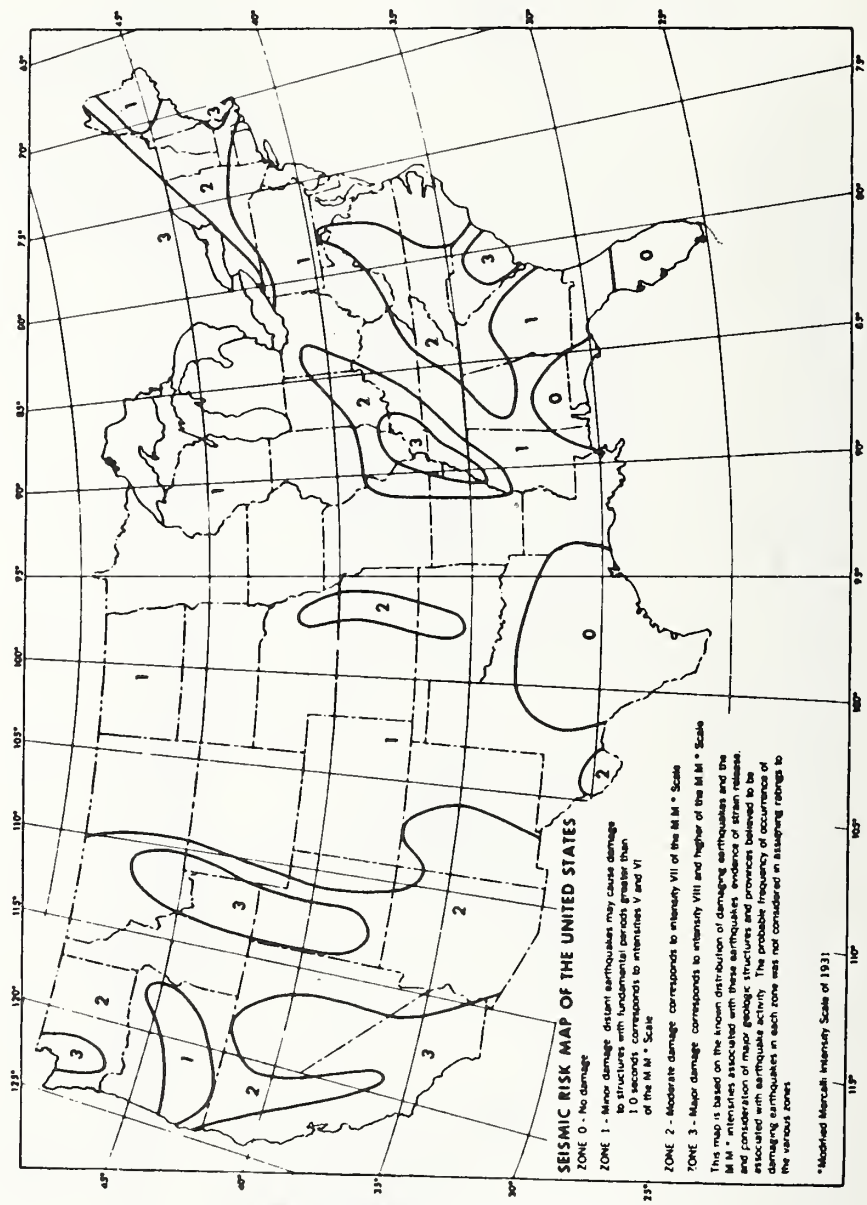

FIGURE NO. 1 — SEISMIC ZONE MAP OF THE UNITED STATES

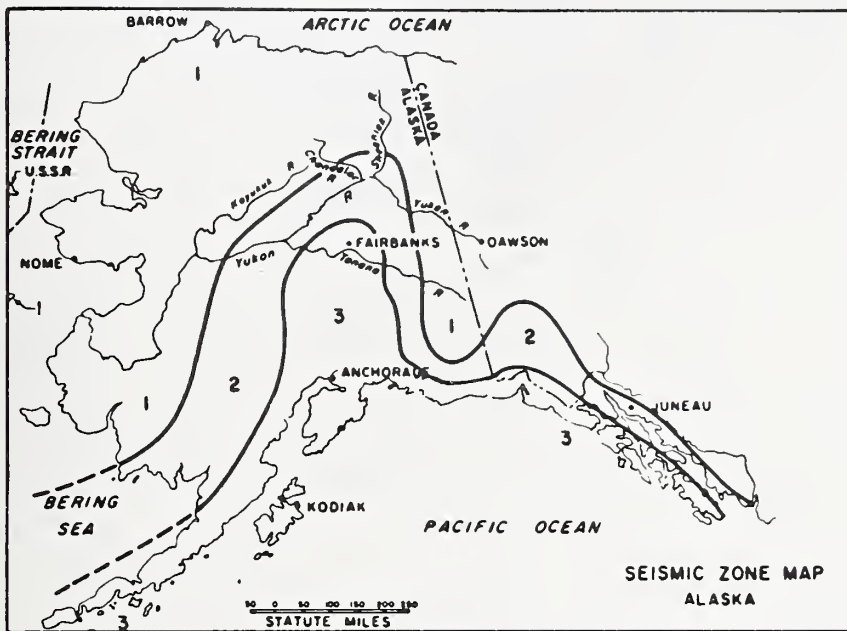

FIGURE NO. 2 — STATE OF ALASKA

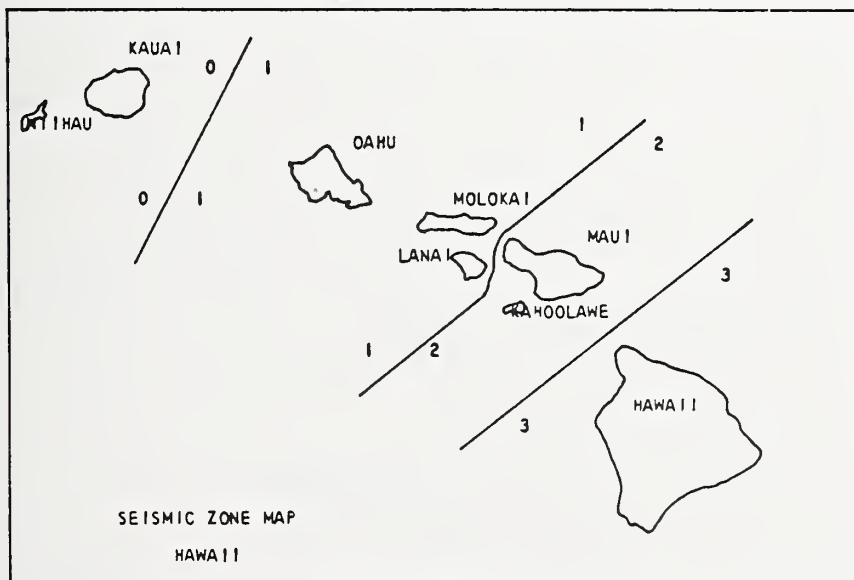
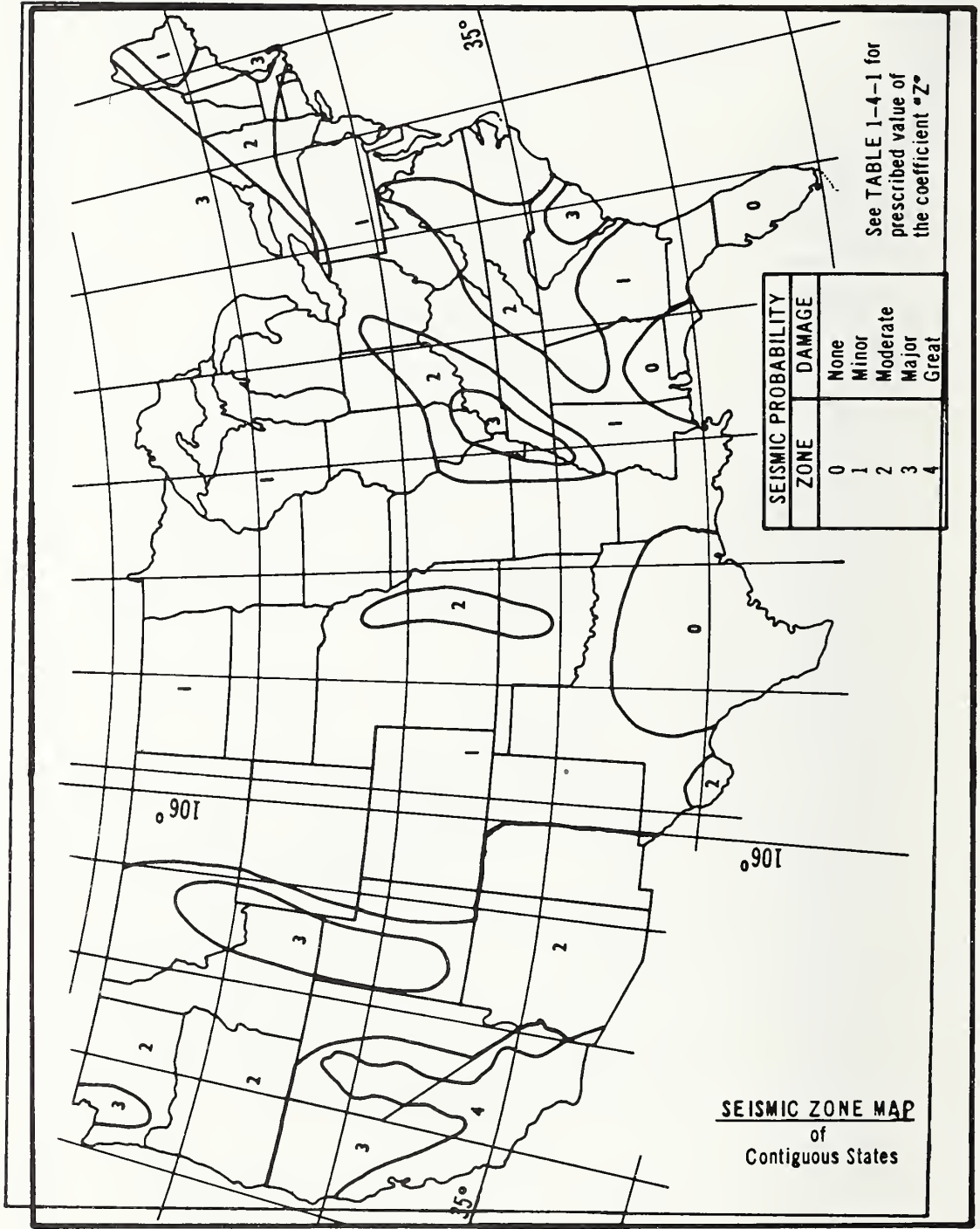

FIGURE NO. 3 — STATE OF HAWAII



ARCHING IN MASONRY WALLS
SUBJECTED TO OUT-OF-PLANE FORCES

Bernard L. Gabrielsen

San Jose State University

and

Kenneth Kaplan

Scientific Service, Inc.

Abstract. Non-reinforced masonry walls, confined between rigid supports that restrict in-plane motions and rotation of wall elements about the supports, can display very high resistance to out-of-plane forces by forming three-hinged arches after cracking in flexure. Analysis indicates that two different types of arching can occur depending on whether a wall is tightly fitted between supports (rigid arching), or is separated from one support by a small gap (gapped arching).

Special static tests were devised to investigate the kinds of loading that occur at the hinges of the arches (line loadings). These tests indicated that rigid arching walls can resist 6 to 8 times the loads that gapped arching walls can, although gapped arching walls are still considerably stronger than either cantilevered walls or walls mounted as simple beams.

An extensive dynamic test program involving full-scale walls, $8\frac{1}{2}$ ft (2.6 m) high and 12 ft (3.7 m) wide, subjected to blast waves in a large shock tunnel, confirmed that brick walls undergoing rigid arching could withstand loadings as high as 19 psi (131 kN/m^2) equivalent to about 34 g. These walls cracked in flexure but did not fail, and then withstood many cycles of reversing loadings with maxima equivalent to accelerations greater than 1 g.

Examples of arching behavior under actual earthquake loadings were found in the San Fernando earthquake of 1971, and the Caracas earthquake of 1967.

A number of important aspects of arching phenomena (e.g. plate or two-way arching, soft arching, effects of curtain walls) still require investigation.

Key Words. Arching; buildings; earthquakes; failure; infill walls; low-level fatigue; masonry; rigid frames; walls.

1. GENERAL

The response of non-reinforced masonry walls to out-of-plane loadings has been studied for approximately eight years as part of a program sponsored by both the Defense Civil Preparedness Agency and the Veterans Administration. While many different types of walls were studied, emphasis in this paper is on "arching walls" -- walls that acquire resistance to out-of-plane motions or forces by being confined in a frame that inhibits in-plane motions and rotation about the walls' supports.

2. FULL-SCALE WALL TEST PROGRAM

For the Civil Defense studies, a unique facility called a shock tunnel was used which enabled full-scale walls to be subjected to air blast loadings over one entire face. Fig. 1 is a cutaway view of the facility, a former coastal defense installation. The area occupied by the shock tunnel is in the foreground. It consisted of a 63-ft (19.2 m) long steel cylinder which served as a "compression" chamber, and a 100-ft (30.5 m) long passageway 8½ ft (2.6 m) high by 12 ft (3.7 m) wide which served as an "expansion" chamber, in which full scale walls were mounted. The expansion chamber opened on a large casemate area which once housed a 16-in. (40.6 cm) gun.



Fig. 1 Cutaway view of the shock tunnel test facility.

Fig. 2 is a closer cutaway view of the shock tunnel. In the domed steel cylinder, 60-ft (18.3 m) long strands of Primacord (detonating fuse) were strung. Upon detonation, the hot, high-pressure detonation products expanded rapidly in the compression chamber and acted like a piston to drive a shock (blast) wave out the open mouth of the cylinder. The cylinder, which experienced thrusts of up to 1,000,000 lbs (4.5×10^3 kN), is held in the tunnel solely by polyurethane foam. The shock wave, moving at a velocity somewhat greater than the speed of sound, proceeded down the expansion chamber, at the end of which it encountered a test wall, which thereupon experienced a generally uniform loading over one entire face.

A still closer cutaway view of the tunnel showing wall mounting details is sketched in Fig. 3. Heavy steel blocks were bolted to the tunnel wall to serve as anchors for steel girders which spanned the tunnel, simulating floor systems in actual buildings. Two additional vertical girders were used in connection with walls that were mounted as plates. Most of the walls were constructed outside the shock tunnel itself in light steel frames. After curing, the wall in its frame was moved into the tunnel and affixed to the girders.

Walls which were mounted as simple plates (with all edges pinned) in the manner shown in Fig. 3, actually exhibited modified arching behavior once flexural failure began. Because of wall bonding to the frame members, the "picture frame" support structure became a perimeter restraining ring (to a rose petal type shell). As a result, arching thrusts developed as shown in Fig. 4, and the walls appeared to be approximately twice as strong as true simple plates would have been. In one impressive case [1], the result of this behavior was to neatly remove a section of wall, approximately 2.5 ft (0.75 m) on a side, from the center of a panel, leaving the remainder of the panel standing. This

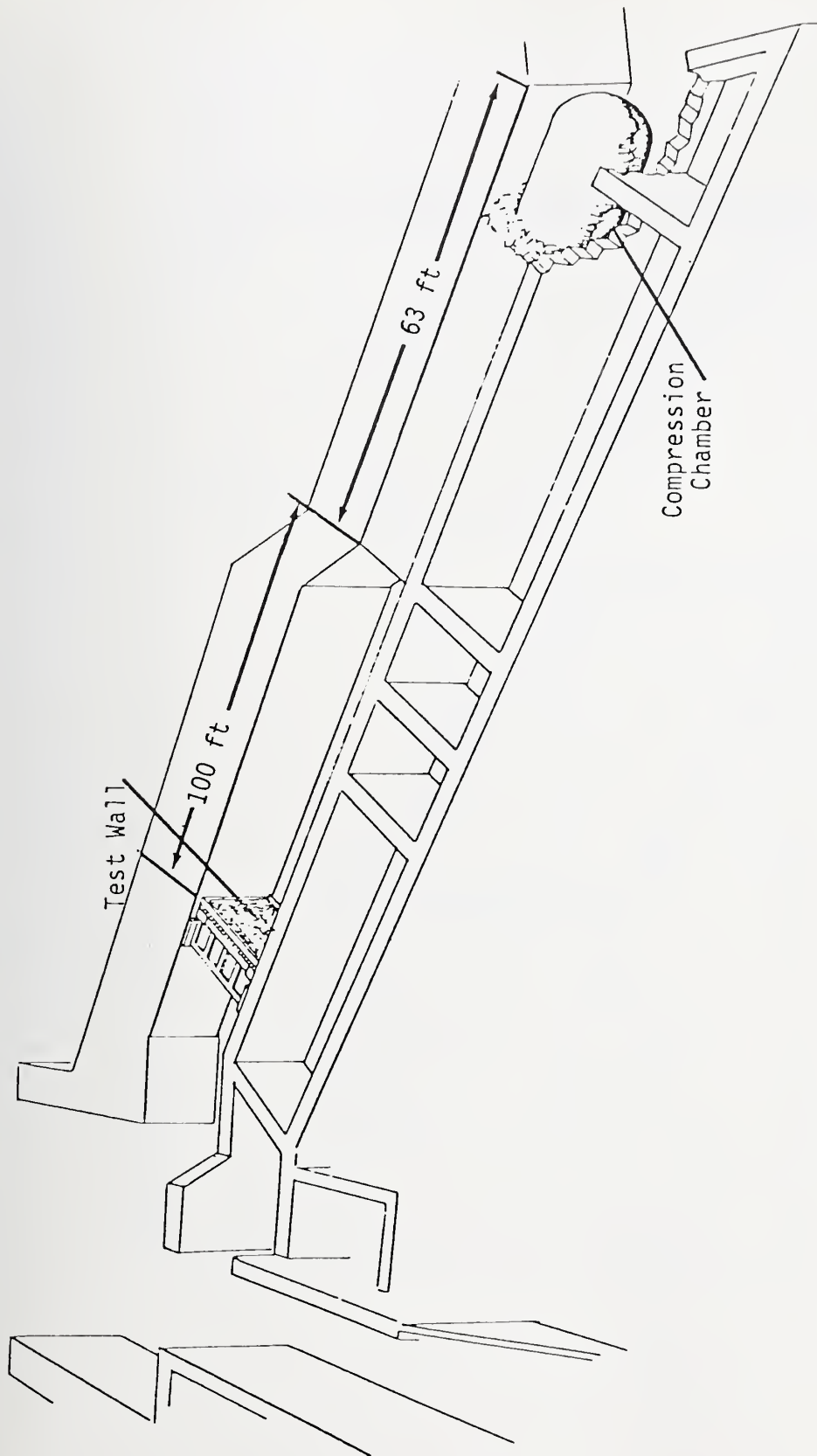

Fig. 2 Cutaway view of shock tunnel showing wall in place.

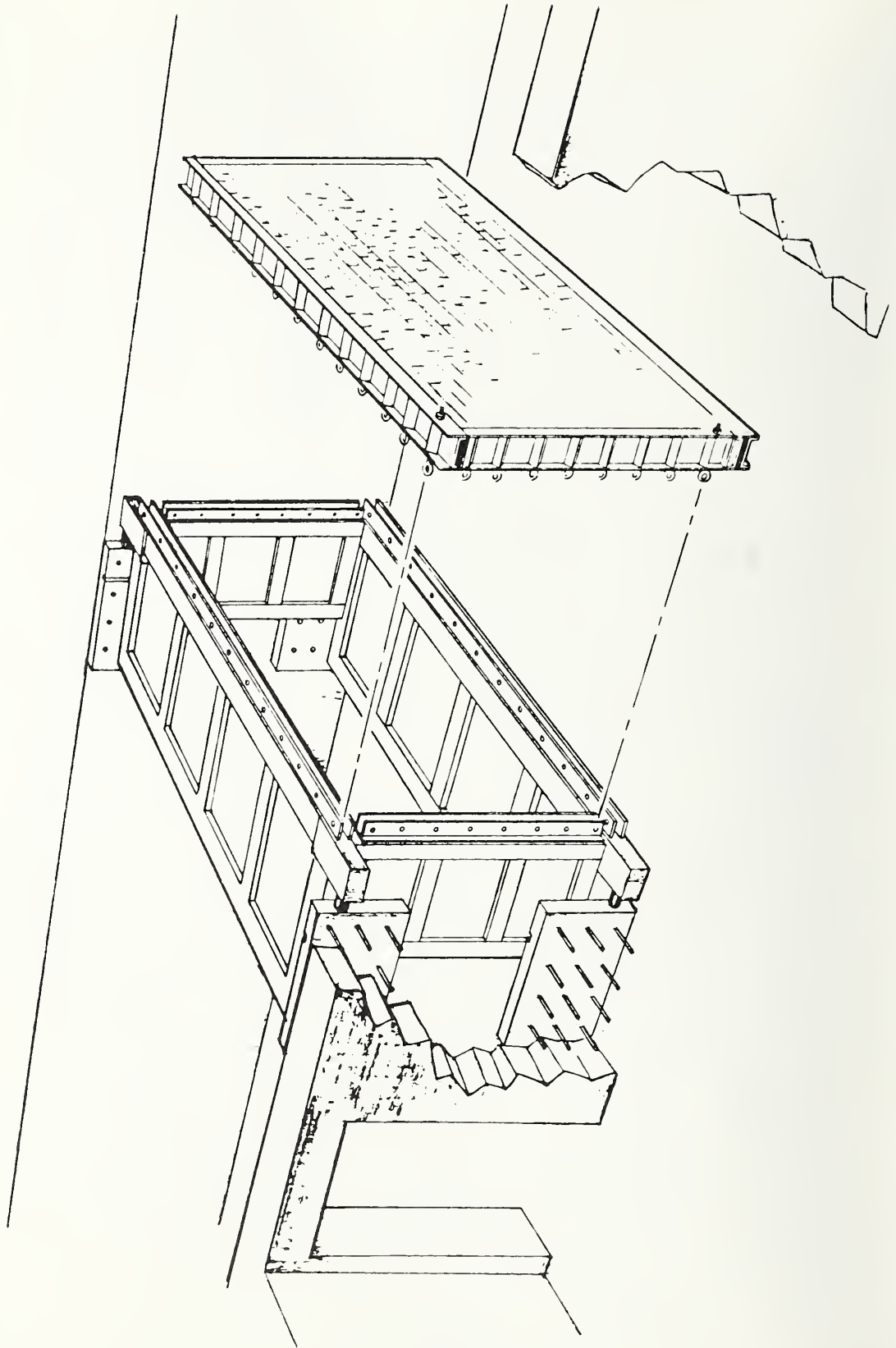

Fig. 3 Cutaway view of shock tunnel showing test panel and simple plate support condition hardware.

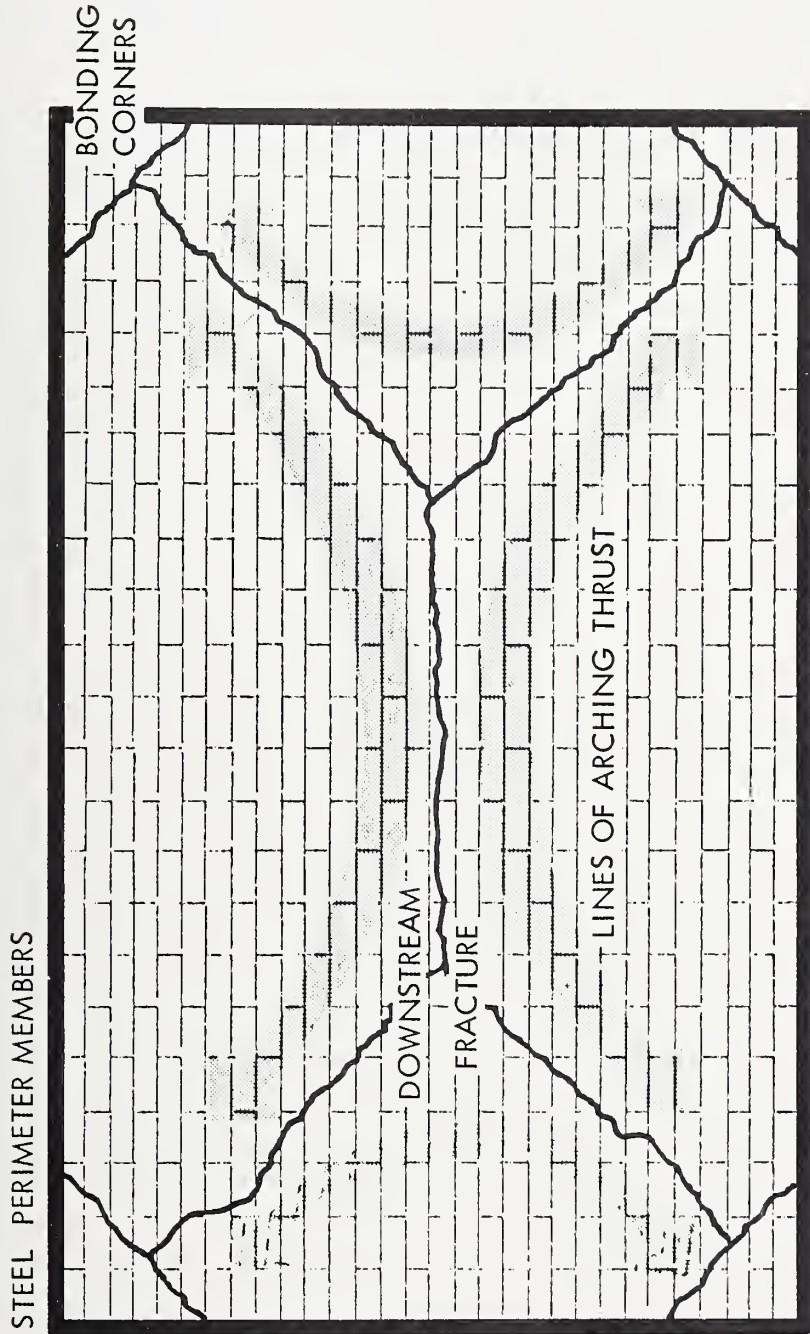

Fig. 4 Thrust lines for modified arching in plate mounted walls.

is shown in Fig. 5. Note the crack pattern on the downstream face of the wall extending from the corners of the hole.

The building of the walls was contracted out to a local bricklayer who was instructed to use normal practices while constructing them. At the same time, the contractor also fabricated many samples to be used in a variety of static tests of material properties and properties of the brick and mortar assemblies. These included samples for compression, shear, and tension tests, and others (beams) to be used in tests for tensile strength in flexure.

Failure statistics reflected a fairly large property variability, as can be seen in Fig. 6, an extreme probability plot of tensile stress at flexural failure [2]. Curve 1 is for specimens carefully constructed in the laboratory, and Curve 2 is for specimens constructed by the bricklayer. The data for both lines show stresses that differ by about a factor of three. There is good correlation between failure stresses in the field and laboratory samples.

3. RIGID AND GAPPED ARCHING

The resistance of walls tightly fitted into rigid frames to out-of-plane loadings has been studied for many years. Theories for walls rigidly restrained on two opposite edges were developed almost 20 years ago [3,4], and more recently refined [5,6]. These indicated that resistance of such walls to out-of-plane forces, brought about by what is termed "rigid arching", could be larger by factors of 10 or more than the resistance of similar walls mounted as simple beams (pinned on two opposite edges).

There was some question, however, whether a wall separated from one of its confining frame members by a gap (which could be caused by poor mortaring techniques, mortar shrinkage, or even by deliberate inclusion of a low-strength flexible seal

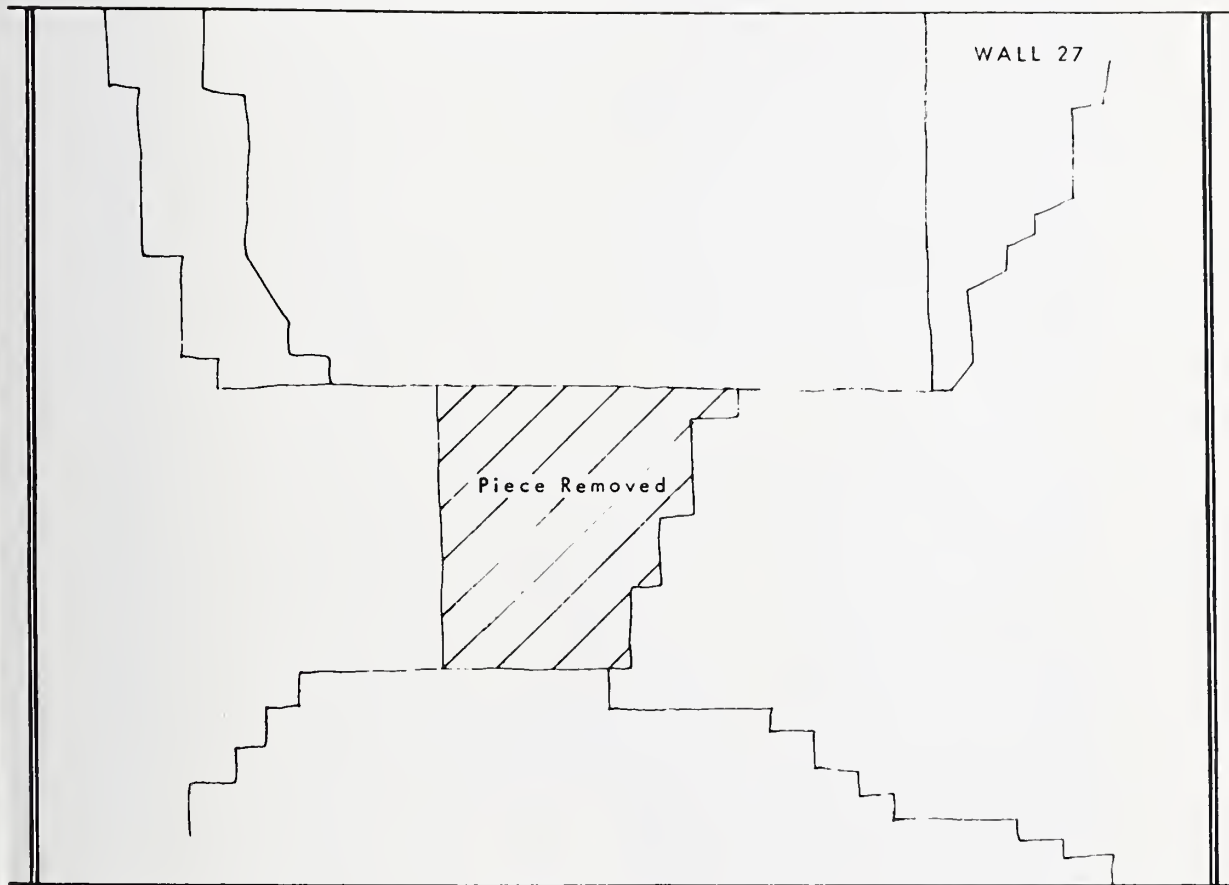

Fig. 5 Sketch of downstream face of plate-mounted wall after loading with over-pressure of 3.5 psi.

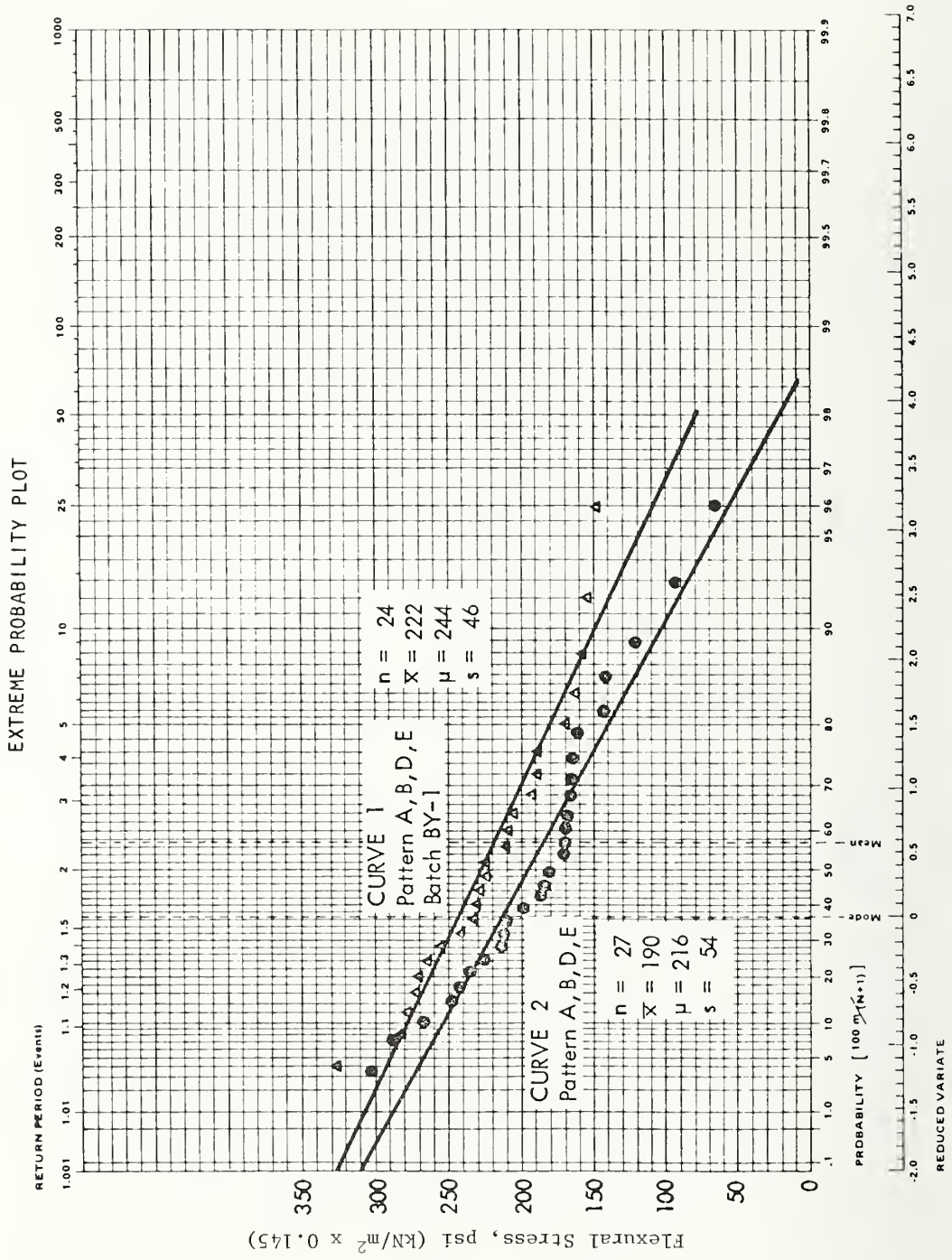

Fig. 6 Comparison of wall specimens and laboratory control specimens (patterns A, B, D, and E).

between wall and frame) would also exhibit arching behavior. It can be shown [7] that a modified form of arching (termed "gapped arching") could take place which would still afford increased resistance to out-of-plane forces over the walls mounted as simple beams, though not nearly as much as is afforded by rigid arching.

The essential differences between the two forms of arching are shown in Figs. 7 and 8. Fig. 7 shows, in exaggerated fashion, the motions that take place. In rigid arching, a symmetrical three-hinged arch is formed; in gapped arching, an unsymmetrical arch is formed. Fig. 8 contains free-body diagrams of the wall elements in the two cases. In rigid arching, forces at the arch hinge points are all directed into the wall (or parallel to its face). In gapped arching forces at two hinge points are directed away from the wall. Thus, in rigid arching, failure at the hinge points should be largely through crushing (compressive) forces. In gapped arching, failure would also take place through spalling (tensile) forces.

In both types of arching, the loads at the hinge points are applied along the hinges, that is along lines in the wall faces. To determine failure strengths under these line-loads, static tests were conducted using the specially designed test configurations shown in Fig. 9, modifications of standard compression test configurations. In 11 tests with rigid arching samples, an average line-load of 4500 lb/in. (7900 N/cm) was required to cause failure; in four tests with gapped arching samples, line loads of about 1000 lb/in. (1800 N/cm) caused failure [7]. Photographs of a rigid arching type of static line-load test are shown in Fig. 10. The sample is one from a wall of a V.A. hospital [8].

The measured values of line-load failure strengths led to static resistance

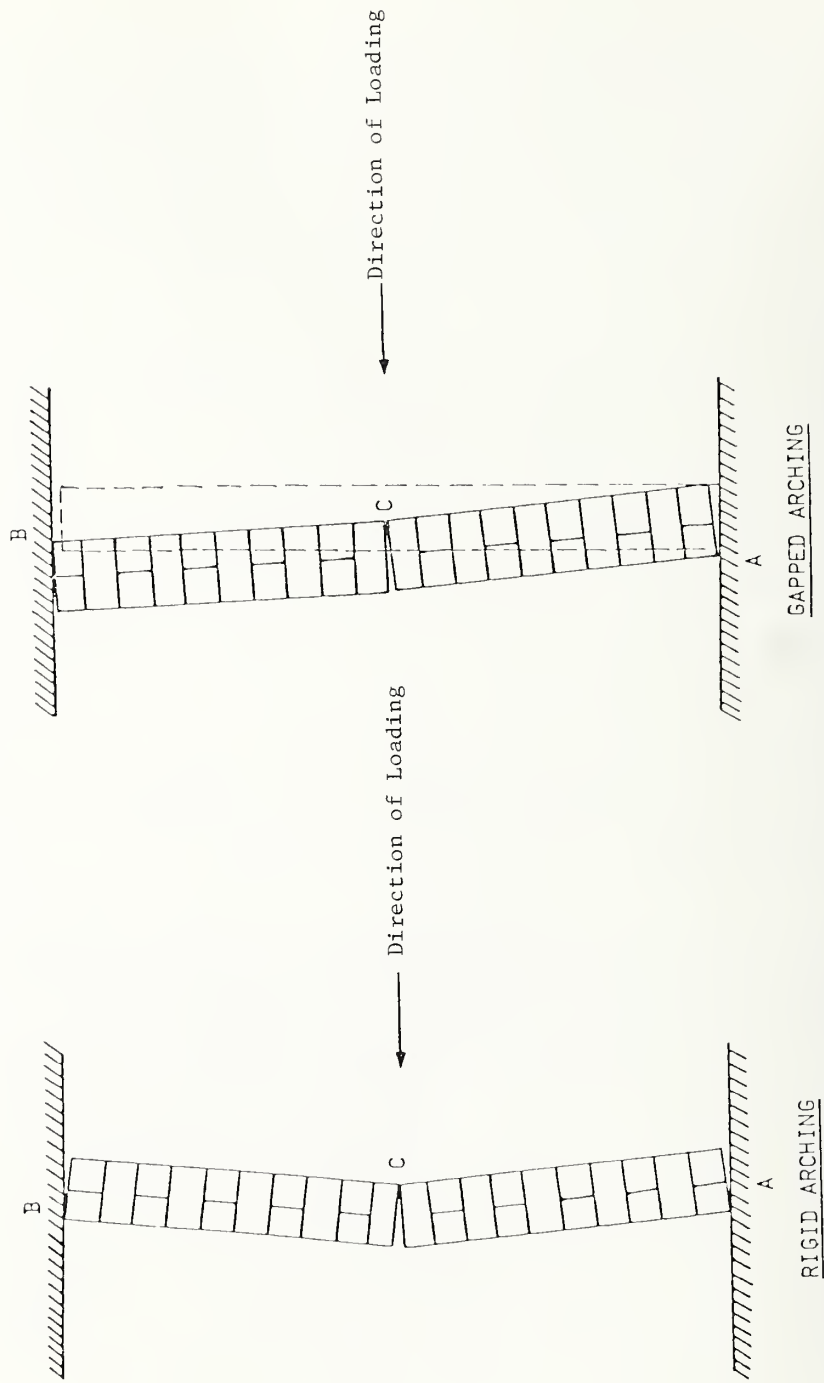

Fig. 7 Sketch illustrating the differences in motion between rigid and gapped arching.

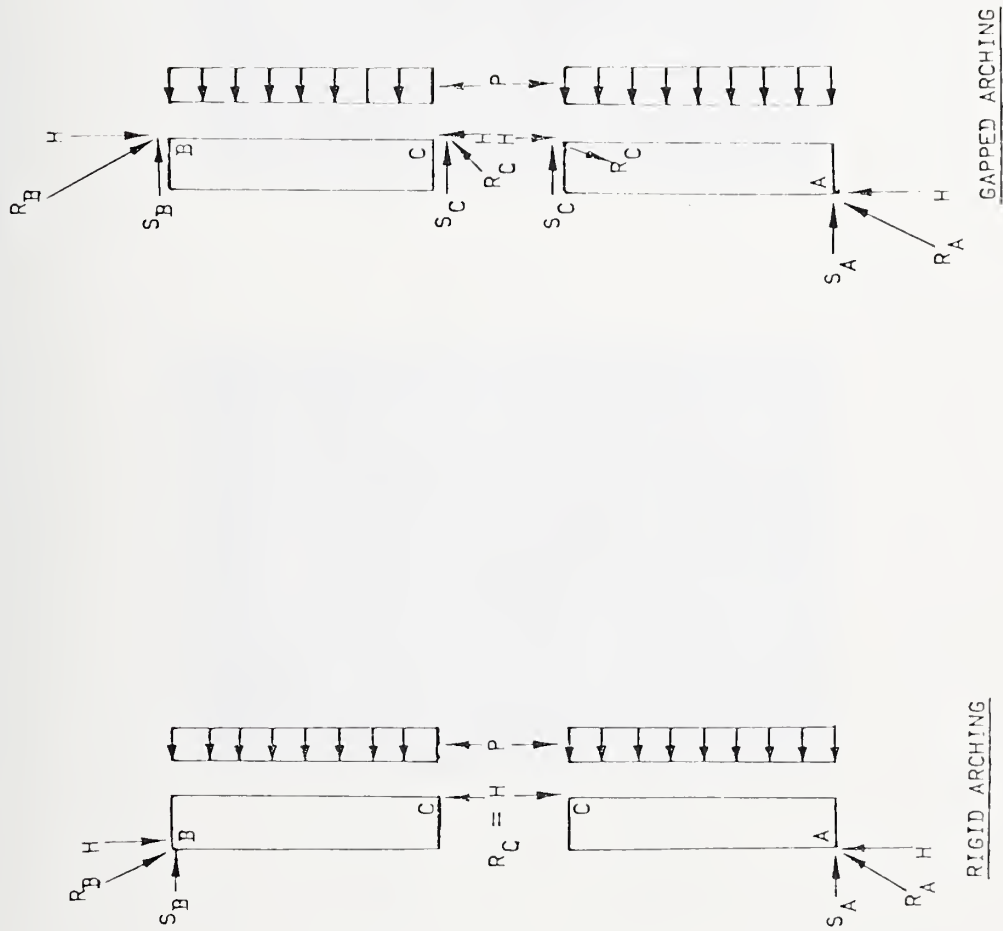

Fig. 8 Free body diagram showing forces in rigid and gapped arching.

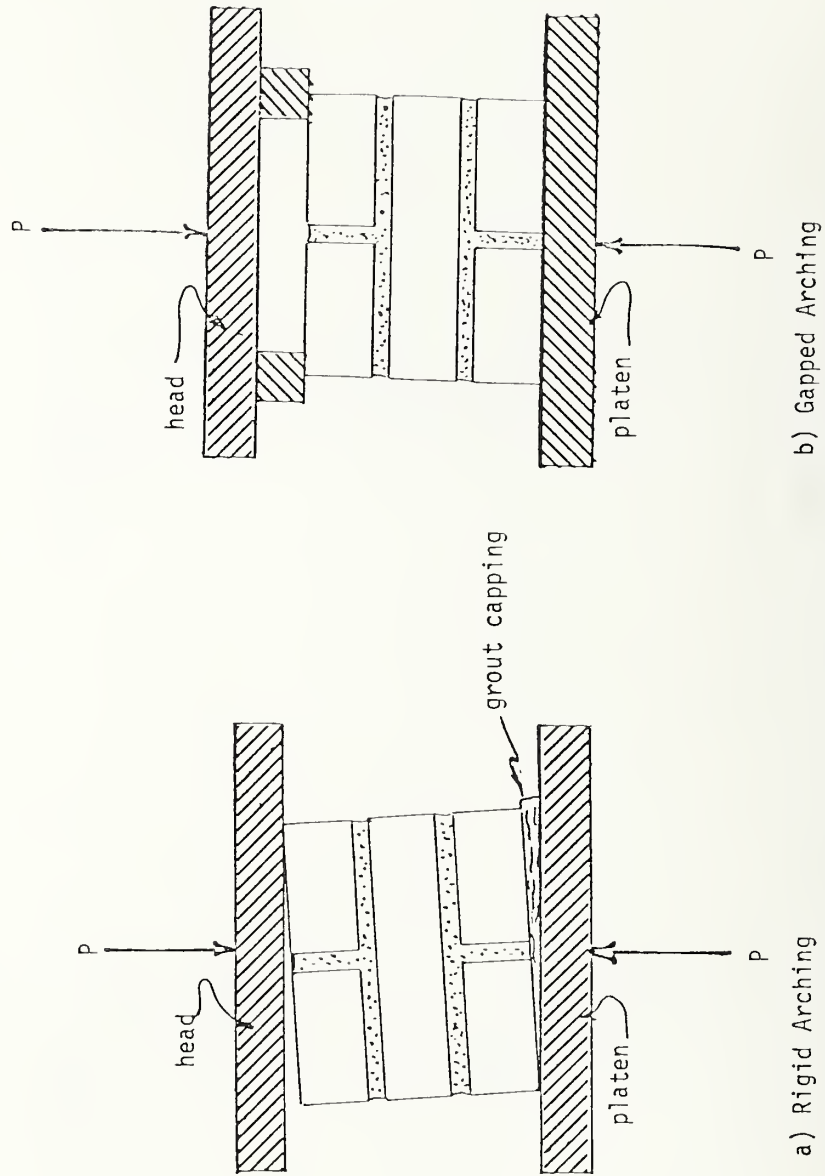

Fig. 9 Configurations for rigid and gapped arching line load tests.

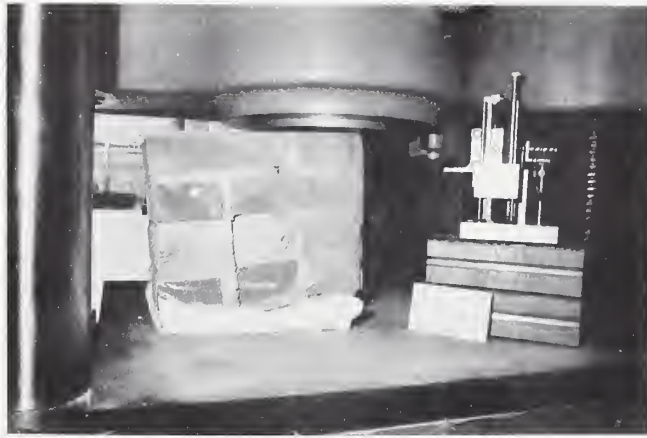

Fig. 10 Pre-, and post-test photographs of a rigid arching type of line-load strength test.

functions for walls (resistance of a wall to uniform loadings normal to one face) such as those shown in Fig. 11. Clearly, the resistance of gapped arching walls is much less than that of rigid arching walls. It should be appreciated, however, that both are still considerably larger than the resistance of non-arching walls. Consider, for example, the four types of walls shown in Fig. 12, on which tests and analysis were conducted, and which resemble each other superficially. Pressures to cause wall failure, and the relative energy absorbed by the walls to the point of their failure (i.e., when they become unstable and would collapse under gravity alone) are shown in Table 1.

Table 1

WALL FAILURE FACTORS

Wall Type	Approximate Failure Pressure psi (kN/m ² x 0.145)	Energy Absorbed (arbitrary units)
Cantilever	0.2	1
Simple Beam	0.9	3
Gapped Arching	2.5	27
Rigid Arching	16.0	350

Theory and experiment for rigid arching walls compare quite well. In Fig. 13 are shown records of motion at the centerline of an 8-in. thick brick wall, tightly fitted between floor and ceiling of the tunnel so as to undergo rigid arching. The wall was tested three times. It was first exposed to a blast loading of 13 psi (90 kN/m²). It cracked in the center, oscillated, but recovered. It was then exposed to a loading of 15 psi (100 kN/m²). Again, it oscillated, but recovered. Finally, it was loaded at 20 psi (140 kN/m²) well above its predicted failure point, and it did fail. Fig. 14 shows a comparison between centerline motion measured during the second test, and predictions of this

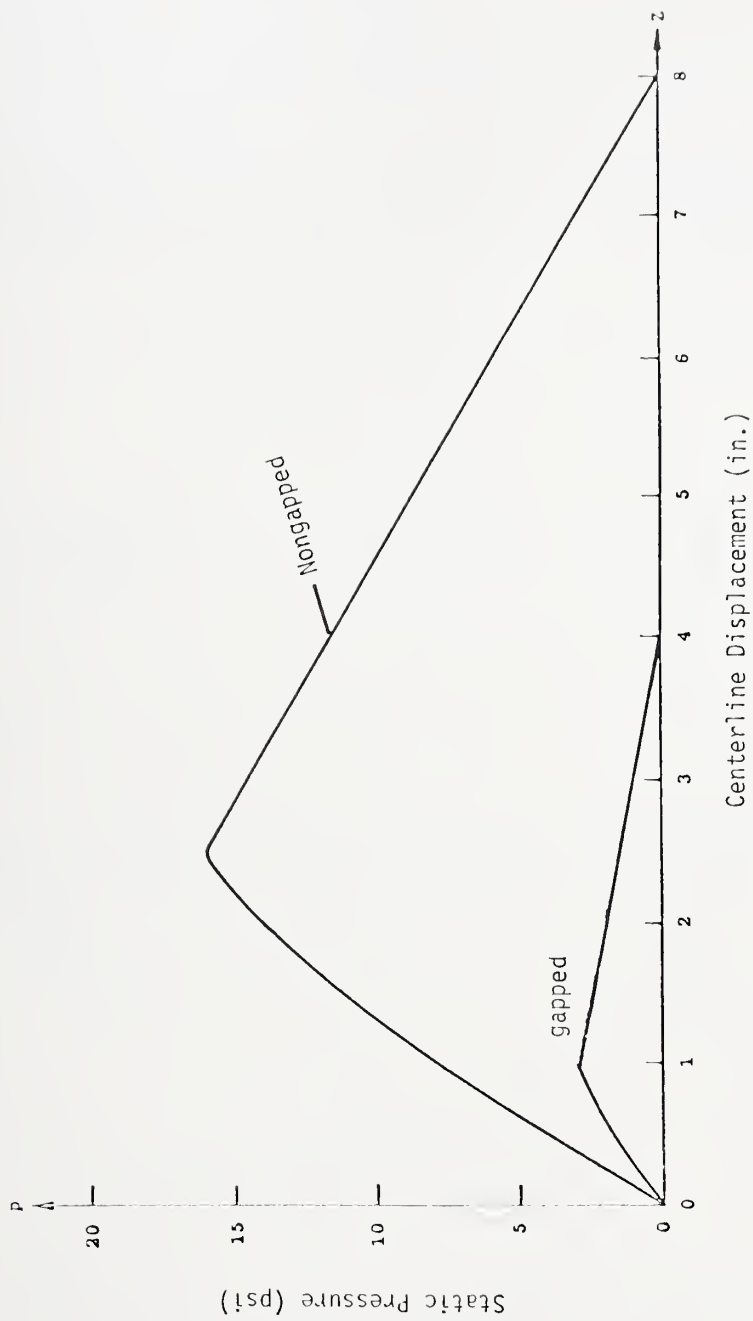

Fig. 11 Arched brick wall, static resistance.

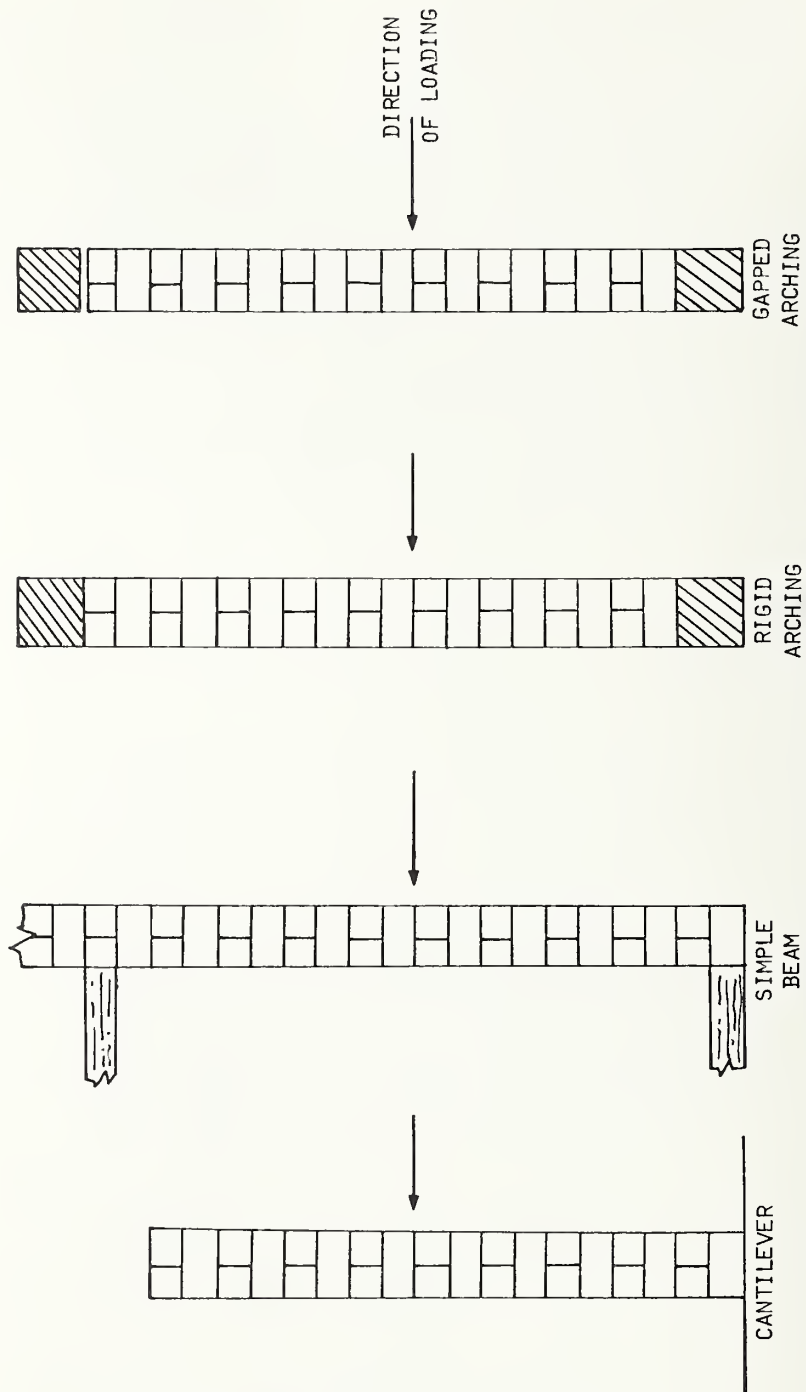

Fig. 12 Types of walls.

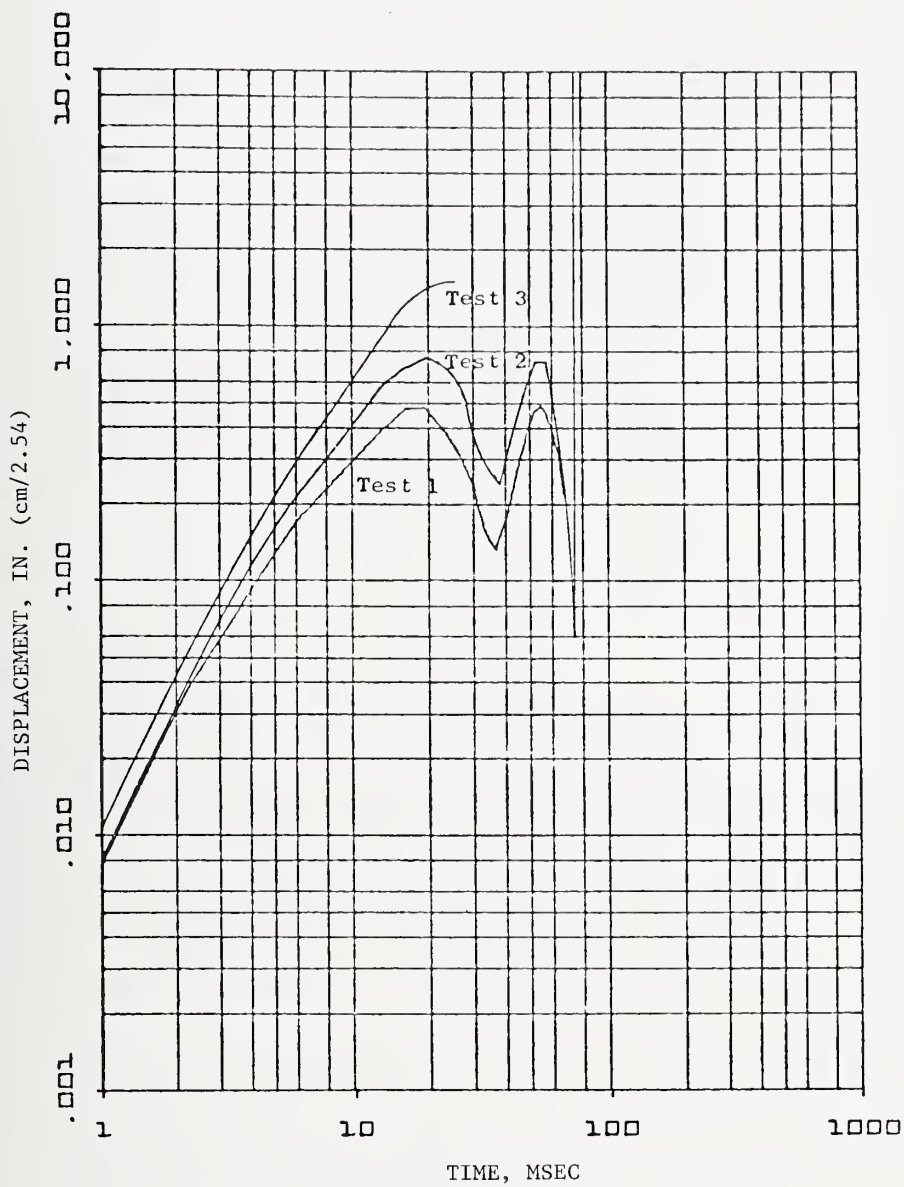

Fig. 13 Displacement as a function of time, wall no. 87, Test 1, 13 psi (90 kN/m²); Test 2, 15 psi (100 kN/m²); Test 3, 20 psi (140 kN/m²).

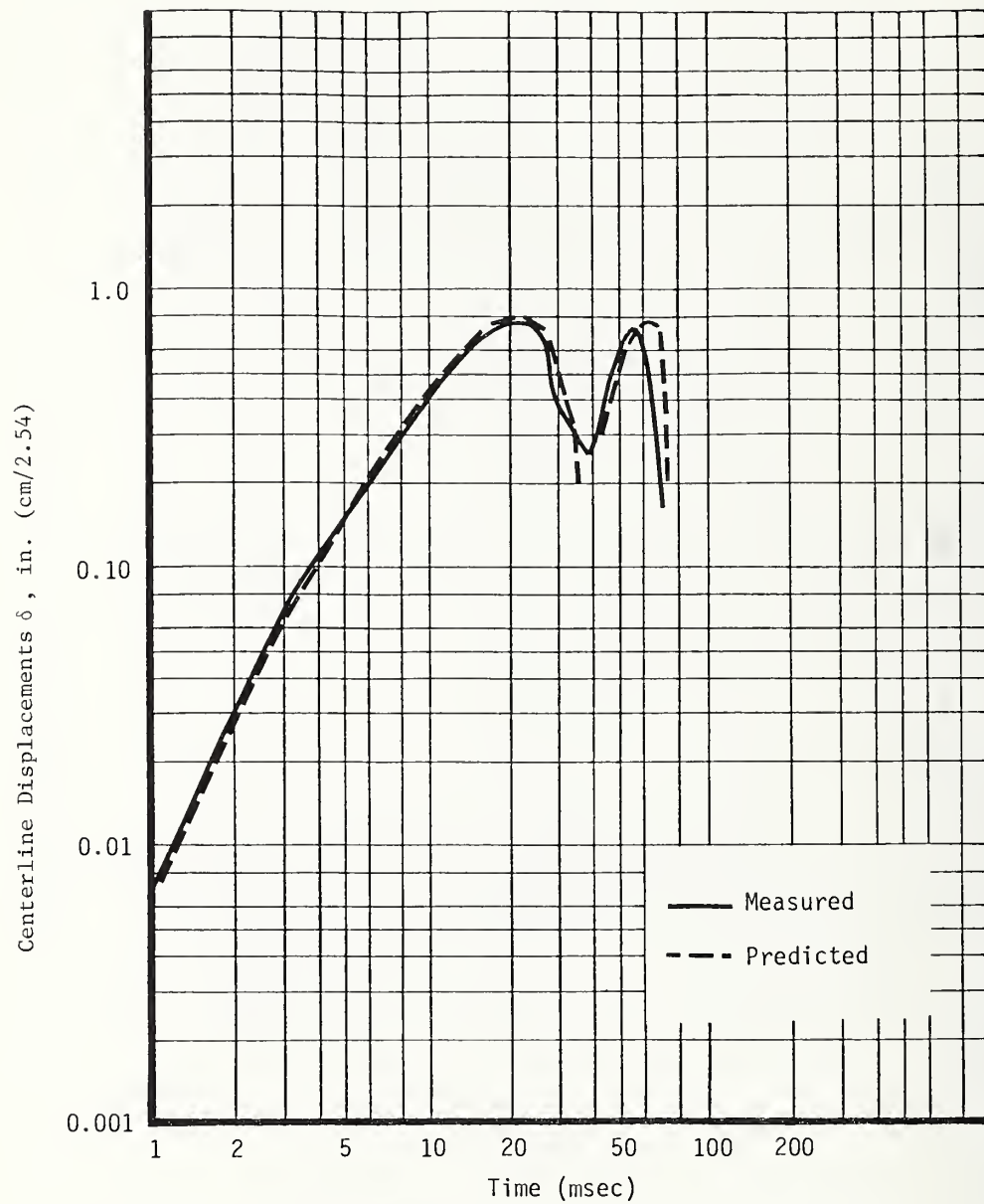

Fig. 14 Predicted and measured wall centerline displacements for a rigidly arching wall vs time from initial blast loading, wall no. 87, second test. Loading pressure = 15 psi (103.5 kN/m²)

motion from a dynamic analysis [6].

As far as resistance to earthquake induced forces is concerned, the uniform blast load converts to an earthquake acceleration by multiplying the load by a factor of 1.8. (This assumes, of course, that a structure and frame can transmit a uniform acceleration to a wall.) Thus, a 15 psi (100 kN/m²) uniform blast loading, which the wall withstood after being cracked by a 13 psi (90 kN/m²) loading, is approximately equivalent to an earthquake acceleration of 27 g. Clearly, arching walls can provide substantial resistance to out-of-plane loadings even after they are damaged.

A special characteristic of the test facility emphasizes how strong arching walls can be even after they crack in flexure. If a wall (even one with a window or doorway opening) struck by a blast wave did not fail, the wave reflected from the wall returned to its source area, (see Fig. 2) then re-reflected to strike the wall again, about 0.3 sec after the first loading. On a second test, if the wall again did not fail, the process was repeated, so that some walls were loaded and reloaded many times. The pulses themselves had a positive loading pulse about 0.1 sec long, followed by a negative loading phase of about the same duration, but of much lower intensity. Thus, these tests provided information on "low-level fatigue", or the ability of walls to withstand a number of reversing loading cycles.

On a single test with a solid wall, each of the many pulses after the first loaded the wall with a maximum pressure about 2/3 the maximum of the preceding pulse. On a test with a wall containing a window opening, each pulse after the first had a maximum pressure about 1/3 of the preceding pulse. But some of the initial loads -- and therefore the succeeding loads as well -- were extremely high in

terms of normal earthquake loadings. Furthermore, the walls that were tested a second time at high initial loadings and still did not fail, were again subjected to intense multiple pulses.

The type of pressure loadings experienced by a solid wall that did not fail is illustrated in Fig. 15, which clearly shows the loading reversals (the troughs of the trace where pressure is negative).

Table 2 gives the loading peaks, with pressures converted to equivalent acceleration in "g" units, experienced by seven brick walls, three of which were built with window openings. In each case, the wall cracked on first loading, but then withstood subsequent load pulses equivalent to very high earthquake accelerations.

4. ARCHING WALLS AFTER EARTHQUAKES

Field evidence confirms that non-reinforced, masonry, in-fill walls can provide increased resistance to out-of-plane loads over non-arching walls. Fig. 16 is a photograph of a building on the grounds of the V.A. hospital at Sylmar, which was exposed to an earthquake in February, 1971. Note that the upper walls facing the observer (which run north-south) are intact while the lower walls have fallen. The east-west walls of this building showed diagonal cracking from shear forces, strongly suggesting that the major direction of the earthquake was in the plane of these walls, that is, normal to the walls shown in Fig. 16.

Fig. 17 is a photograph of the first floor area of the same building where the north-south walls had been. Note the spalling and concrete failure at the top of the column in the photograph, which suggests that the frame did not behave as a rigid member as required for rigid arching to occur, i.e.. the lower wall was not adequately restrained, and the upper one was. Fig. 18 is another example



Fig. 15 Shock tunnel pressure gauge traces. Gauges mounted in nonfailing wall (peak reflected overpressure, first peak 5 psi.)



Fig. 16 Masonry infill wall and frame building at Sylmar, California.



Fig. 17 Detail of Sylmar building showing spalling at top of column.



Fig. 18 Detail of Sylmar building showing failure at corner column.

of frame failure in the same building that prevented arching from occurring, and caused failure of the first-floor walls.

A photograph of another building in the same area as that shown previously, and of similar construction, is shown in Fig. 19. The parapet wall (a cantilever wall) failed, but the other exterior walls, which could have arched in their frames, did not fail.

A building in Caracas whose walls show evidence of severe loading is shown in Fig. 20. Walls in both the face of the building in the photograph, and in the hidden side of the building were identified as being infill walls in rigid frames [9]. None failed.

5. NEEDS OF A DESIGNER

Considerable effort is needed before the foregoing analyses can have a firm basis for practical application. The notion of a line-load which results in failure is relatively new, and the statistics of material strengths under such loadings are virtually non-existent. Many more tests involving the rigid arching type of failure (crushing) are needed, as is another method for evaluating the gapped arching type of failure (spalling). The test configuration shown in Fig. 9 only crudely approximates the actual mode of failure. Materials other than brick must also be studied.

The gapped arching analyses of [7] has not been adequately verified experimentally. In addition, while some preliminary work [10] has been done on cracked walls (rather than walls with a gap) more analyses and experiments are in order.

Very little work has been done on some other important aspects of the general arching problem. For example:



Fig. 19 Building at Sylmar, California in which parapet wall failed, but other walls did not fail.

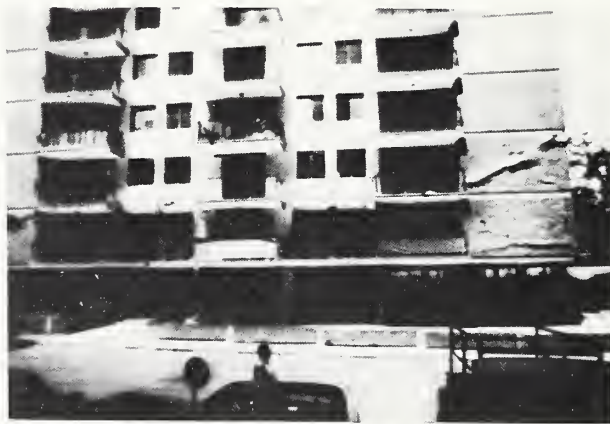

Fig. 20 Building at Caracas, Venezuela showing cracked infill walls.

- The problem of "two way" or "plate" arching (where in-plane motions are restricted by rigid supports on all four edges) has received some consideration [11, 12], but the existing approaches do not consider any effects of gaps between wall and frame, or of cracks in masonry.
- Consideration has been given [7] to the effect of full-wall-height doorway openings on arching, but no analysis has been made of effects of window or partial-wall-height doorway openings.
- The changes in wall resistance that result from supports that are not perfectly rigid (termed here "soft arching") have been considered [13], but again more work is needed, as the existing analysis is an extension of the earlier rigid arching approaches.
- Little work has been done on determining wall response to forces that are directed neither normal to, nor parallel to, infill walls in a frame building. A fair amount of effort has gone into evaluating shear capacity of walls under in-plane loading [14, 15] and some has been done to evaluate the decrease in shear capacity due to cracks [15, 16, 17]. However, the effect on resistance to out-of-plane motions of both cornering and in-plane motions and their subsequent damage to the walls, has by no means received adequate attention.
- One problem that appears not to have been addressed at all involves a very common structural class: structures with curtain walls separated from the frame and its infill walls by a cavity. The curtain walls will most assuredly fail at lower loadings than will the infill walls if these have any tendency to arch at all. Whether a curtain wall failure can adversely affect an infill wall's capacity to arch is unresolved.
- The response of wall systems rather than individual walls requires consideration. It is easily conceivable that failure of a single wall in

a building could lead to failure of other walls that would otherwise withstand the forces imposed on them, because the first wall's failure altered the other walls' support and loading conditions.

It should also be appreciated that, while many of the problems associated with wall resistance to out-of-plane loadings, described in the preceding material, lend themselves to computer analysis, relatively little has been done in that regard.

6. REFERENCES

1. Willoughby, A.B., C. Wilton, B.L. Gabrielsen, J.V. Zaccor, "Loading, Structural Response, and Debris Characteristics of Wall Panels", URS 680-5, URS Research Company, San Mateo, California, July 1969.
2. Wilton, C., B. Gabrielsen, J. Edmunds, S. Bechtel, "Loading and Structural Response of Wall Panels", URS 709-4, URS Research Company, San Mateo, California, November, 1969.
3. McDowell, E.L., K.E. McKee, E. Sevin, "Arching Action Theory of Masonry Walls", ASCE Journal of the Structural Division, Proceedings Paper 915, March, 1958.
4. McKee, K.E., E. Sevin, "Design of Masonry Walls for Blast Loading", ASCE Transactions, Paper No. 2988. Volume 124. 1959.
5. Wilton, C., B.L. Gabrielsen, "Shock Tunnel Tests of Preloaded and Arched Wall Panels", URS 7030-10, URS Research Company, San Mateo, California, June, 1973.
6. Wilton, C., K. Kaplan, B. Gabrielsen, J. Zaccor, "Blast/Fire Interaction, Blast Translation, and Toxic Gases", SSI 742-8. Scientific Service, Inc., Redwood City, California, 1976 (in publication).
7. Gabrielsen, B.L., C. Wilton, "Shock Tunnel Tests of Arched Wall Panels", URS 7030-19, URS Research Company, San Mateo, California, December, 1974.
8. Gabrielsen, B.L., K. Kaplan, C. Wilton, "A Study of Arching in Non-Reinforced Masonry Walls", (Prepared for Veterans Administration) Report 748-1, Scientific Service, Inc., Redwood City, California, March, 1975.
9. -- "Preliminary Report, The Behavior of Reinforced Concrete Structures in the Caracas, Venezuela Earthquake of July 29, 1967", Portland Cement Association, Los Angeles and San Francisco, California.
10. Gabrielsen, B.L., C. Wilton, K. Kaplan, "Response of Arching Walls and Debris from Interior Walls Caused by Blast Loading", URS 7030-23, URS Research Company, San Mateo, California, February, 1975.
11. Abrahamsson, Eddy, "Dome Action in Slabs", Stockholm, 1967.
12. Brotchie, J.F., A. Jacobson, S. Okubo, "Effect of Membrane Action on Slab Behavior", Massachusetts Institute of Technology, August, 1965.
13. Wiehle, C., J.L. Bockholt, "Summary of Existing Structures Evaluation, Part I: Walls", Stanford Research Institute, Menlo Park, California, November, 1968.
14. Fiorato, A.E., M.A. Sozen, W.L. Gamble, "An Investigation of the Interaction of Reinforced Concrete Frame and Filler Walls", Civil Engineering Studies, Structural Research Series No. 370, University of Illinois, Urbana, November, 1970.
15. Lefter, J., J. Colville, "Reinforcing Existing Buildings to Resist Earthquake Forces", Proceedings of the National Conference on Earthquake Engineering-1975, Ann Arbor, Michigan, Earthquake Engineering Research Institute, Oakland, California, June 1975.
16. Blume, J.A., N.M. Newmark, L.H. Corning, "Design of Multistory Reinforced Concrete Buildings for Earthquake Motions", Portland Cement Association, 1961.
17. Lefter, J., "Reinforced Concrete Frames with Masonry Filler Walls", Unpublished Manuscript, Chapter VI.

SOME THOUGHTS ON MINIMUM REQUIREMENTS FOR THE
SEISMIC DESIGN OF LOAD BEARING MASONRY BUILDINGS

Richard M. Gensert
Gensert Peller Mancini Associates
Consulting Structural Engineers

Abstract. A shear wall is analyzed for a 5, 10 and 15-story building for two typical wind zones and four seismic zones. The result shows that one might design a tall unreinforced building in all zones but 3 and 4 for seismic conditions. It is suggested that the need for criteria regarding ductility should come from the testing of actual buildings.

Key Words. Current research; Ductility; Full scale testing; High-rise masonry; Scale factors; Shear walls.

1. HISTORICAL BACKGROUND

The ability of a reinforced masonry building to withstand seismic forces without major damage has recently been proven in California. The capacity to absorb micro movements as units float within mortared boundaries, offers energy absorption unlike that of any other material. However, there is another movement that may stifle the industry by requiring West Coast minimum standards for earthquake in all regions of this country regardless of seismic intensity.

We must also admit that many masonry buildings designed for non-earthquake or minimum earthquake requirements have no ductility properties to resist the many unknown or uninvestigated secondary stresses that occur. Thus, there is a gap between the two schools of thought regarding the basic requirements of safety and performance. Hopefully, this gap may be closed through selective research.

2. COMPARATIVE BUILDING STUDY

First let's look at a transverse masonry shear wall for a typical apartment building. We will examine both out of plane and in plane stresses for wind loads and for seismic loads.

2.1 Criteria. Cross walls are both bearing and shear resisting; Story heights are 9' (2.74m); Walls are in pairs and not coupled; Building heights are 5, 10 and 15 stories; Wall types are: C-90 concrete block, with grouted cells (12") (30.48 cm); Concrete

block wythes with grouted interior wythe (12"); Brick wythes with grouted interior wythe (12"); Brick wythes with grouted collar joints (12"). (It should be noted that the various masonry wall systems are comparable when unit strengths or densities are varied.)

2.1.1 Out of Plane Stresses.

2.1.1.1 Lateral Loading. 90 mph (145 kph) wind loads common to most of the U.S. represents a uniform wind pressure of 25 psf (120 kpm²).

Seismic forces for Zone 4 requires an equivalent pressure of 24 psf (115 kpm²).

2.1.1.2 Summary. Seismic does not control for out of plane stresses, since allowable shear and tension stresses (1/3 increase in stress levels) are not exceeded.

2.1.2 In Plane Stresses.

2.1.2.1 Lateral Loading. Wind pressures used in design were: 90 mph (25 psf) and 125 mph (200 kph) (40 psf) (190 kpm²).

Seismic forces were used for Zones 1, 2, 3 and 4.

Reinforcing, when required, is in the 5-foot stress block at either end of a wall.

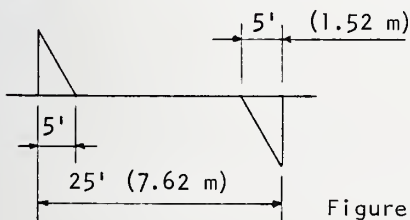

Figure 3

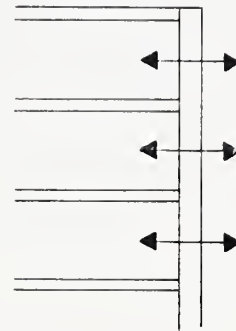

Figure 1

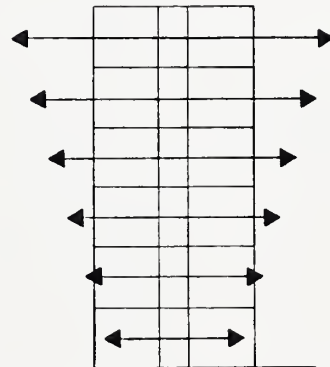



Figure 2

2.1.2.2 Summary. Reinforcing requirements for the masonry is indicated in the following table (Figure 4).

- Brick = 12,000 psi (840 kpcm²)
- Block = 6,000 psi (420 kpcm²)

Masonry Wall Requirements

Figure 4

Unreinforced Masonry 
 Reinforced Masonry 

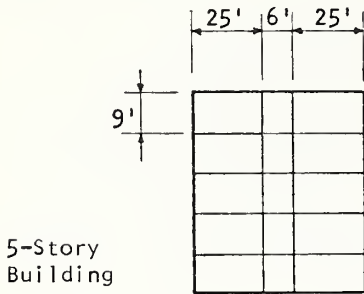

R	Wind		Seismic			
	90 mph	125 mph	Zone 1	Zone 2	Zone 3	Zone 4
5						Reinforced
4						Reinforced
3						Reinforced
2				Reinforced	Reinforced	Reinforced
1				Reinforced	Reinforced	Reinforced

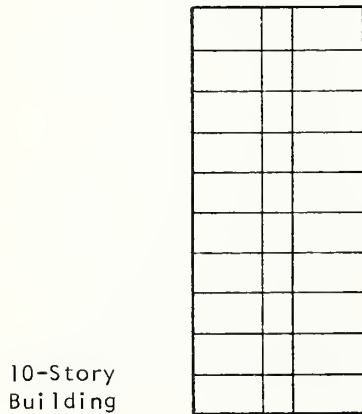

R	90 mph	125 mph	Zone 1	Zone 2	Zone 3	Zone 4
10						Reinforced
9						Reinforced
8						Reinforced
7						Reinforced
6					Reinforced	Reinforced
5					Reinforced	Reinforced
4					Reinforced	Reinforced
3					Reinforced	Reinforced
2				Reinforced	Reinforced	Reinforced
1				Reinforced	Reinforced	Reinforced

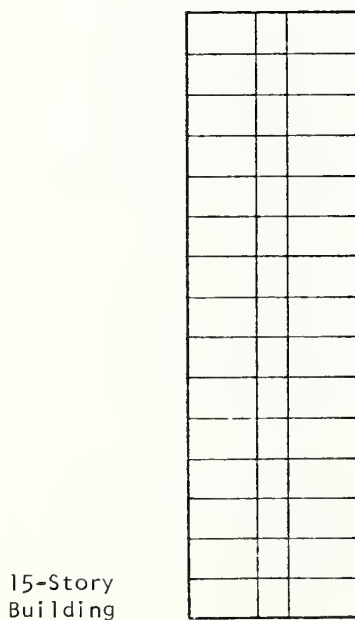

R	90 mph	125 mph	Zone 1	Zone 2	Zone 3	Zone 4
15						Reinforced
14						Reinforced
13						Reinforced
12						Reinforced
11					Reinforced	Reinforced
10					Reinforced	Reinforced
9					Reinforced	Reinforced
8					Reinforced	Reinforced
7					Reinforced	Reinforced
6					Reinforced	Reinforced
5					Reinforced	Reinforced
4					Reinforced	Reinforced
3					Reinforced	Reinforced
2		Reinforced		Reinforced	Reinforced	Reinforced
1		Reinforced		Reinforced	Reinforced	Reinforced

It is apparent from Figure 4 that Zones 3 and 4 will require reinforced masonry. Although one should not design a 15 story masonry building in Zone 1 or 2 without reinforcing, it is obvious that the present static design procedures for earthquake are not adequate since there is no method for determining the required ductility.

Our own office practice has been that of reinforcing the ends of shear walls with steel based on 25% of the seismic moment, assuming the wall has no prestress and no strength. We do not always use minimum vertical reinforcing between the reinforced edges of a wall. Openings in the walls are reinforced on all four sides. Floor and roof slabs are tied together to produce horizontal diaphragms which are also tied to the walls with reinforcing to keep them together and transmit shears. Walls continuous around corners are either fully bonded, or intermittently tied together depending on their structural requirements. Thus, each panel of load carrying masonry has a reinforced horizontal and vertical boundary with a positive connection.

It is true that these standards saved two masonry buildings in the Xenia, Ohio tornado that destroyed the Central State College Campus in 1974, but we must admit to a lack of rationale.

3. THE QUESTION OF DUCTILITY

What is a logical method of determining ductility? Should it be based on minimum reinforcing size and spacing constant to all zones - or should it be keyed to stress levels as well as building and wall configurations? Is there a relationship between reinforcing requirements for ductility and the type of masonry wall construction? - or masonry unit geometry? masonry strength? - or dynamic response of the building's geometry? For that matter should ductility be a universal requirement? What about a two-story residence in Zone 1? The answer to this important question must come from research.

4. RESEARCH MUST REFLECT CONSTRUCTION METHODS

Much research is needed for the code writers and designers to produce safe and logical buildings, and I am pleased that we have been introduced to current project underway in several Universities. Yet one cannot help but comment on their direction and results.

Research should be closely tied with construction practices that reflect all regions of the country both in terms of unit geometry and assembly. Understanding the relationship of masonry units, mortar and grout may lead to more economical structures and better testing. For example, mortar strengths should be less than unit strengths if compression is the only requirement, but greater if shear and tension are needed. Grout should match the modulus of elasticity of the unit it fills to obtain uniform strains and special precautions can be taken to prevent shrinkage of grout within masonry cells or

grouted wythes by reconsolidation of the grout. Many areas of the country vary the density of the units and grout only those cells requiring reinforcing. Composite construction of masonry walls is almost universal.

The transmission of horizontal shear stress from lateral forces through wall and floor intersections is very important information to a designer; however, tests with short-stiff floor and wall panels bonded together do not reflect actual conditions. Wall and floor panels in a building are large enough and insufficiently tied together to give flexibility through torsion and slippage. How does this resistance change with the load in the wall? What happens to this slippage when motion is perpendicular to the wall?

Current laboratory testing indicates that values of h/d beyond 5 for prisms are too erratic and should not be attempted. One cannot help but wonder about the 20-story building with h/d values of 20 or more, and if eccentricity is the culprit, should we use different values of f_m' for end walls as compared with interior walls? - or can we assume that designing for the eccentricity is sufficient?

What is the difference in performance of composite walls as against non-composite? - with respect to creep - with respect to thermal variations and their combined effect under load. What about f_m' for unsymmetrical composite walls?

Should we not establish special criteria for reinforcing when placement patterns deviate from direction of principal stress? Will over-reinforcing produce strain incompatibilities as evidenced by recent research?

5. REALISTIC RESEARCH

Well, there are a host of other concerns regarding masonry structures that need discreet testing in laboratories such as we have heard from, but I also think another great laboratory is the building itself. Instrumenting a structurally isolated section of a building for load transfer and thermal reactions is not difficult, and does not present problems with scale factors. Gravity loading is free and shaking can be accommodated by no more than two portable shakers. The final comparison of mathematical models developed from parts versus the whole would be of great scientific benefit to all of us.

DISCUSSION
* * * *

Mayes, University of California, Berkeley:

For Dick [Gensert]: You made a concluding comment that we could get valuable information from full-scale testing -- full-scale buildings. Were you referring to dynamic loadings?

Gensert, (Gensert, Peller, Mancini Associates):

I'm referring to both types, yes.

Mayes:

How would you envisage getting sufficient force into the building in the case of a masonry shear wall building to cause significant damage? There are two forms of tests; one: you can do low-amplitude tests to determine the dynamic properties (and this is being done on many buildings); and the next stage, over and above that, is to do large amplitude tests in which you're going to cause some damage wherever the critical element may be. But, to generate forces sufficient to do that requires pretty large shakers and, I think, much larger than the ones you're envisaging.

Gensert:

Yes, it would require large shakers. There are two in California that we have our eyes on.

Mayes:

I'm leaving tomorrow for a test in St. Louis on an eleven-story reinforced concrete building; that's just a frame building. We designed the shaker for that; and the shakers you are referring to in California certainly are completely inadequate for what you're envisaging. The shaker we've designed for St. Louis I'm sure would be inadequate for a masonry load-bearing shear wall structure. You'd require something tremendous to get the forces necessary to cause any significant damage. I think we have a long way to go before we can look at testing of full scale structures.

Gensert:

I don't know that we're looking for complete failure of a building through tests, but I think that we are looking for performance, which means that we don't have to go all the way to destruction.

Mayes:

But to get those forces into the building I think is well beyond our capability.

Gensert:

Well, I think if we're looking for a distribution of strains, let's say, and any slippage that could occur, we could accomplish a lot by doing that.

Hegemier, University of California, San Diego:

Dick, I just wanted to amplify some remarks that Ron [Mayes] had made. Something comes to my mind immediately and that is the years of testing that has gone on at CAL TECH, with respect to the Millikan Library. That's been a really difficult situation in terms of instrumentation, interpreting the data, and finally finding out that soil/structure interaction was a problem, when, in the beginning, it was thought not to be a problem. The whole thing is in the elastic range essentially; and I think it's a very difficult thing to do--to not only shake the building at the proper amplitude where you can begin to get data that mean something, but to instrument the building and then to try to interpret the data to come forth with some meaningful results. I don't think it's quite so simple, and I agree with Ron that we're a distance away from full-scale testing.

Gensert:

I think if you're talking about a complete building (let's say 60 feet wide by about 100 feet long) you certainly have a good point. If we're talking about a portion of a building (let's say about 30 to 40 feet wide and maybe only two bays in the long direction) I think you can easily shake that one--certainly a building 200 to 300 feet in all.

Mayes:

What height are you looking at?

Gensert:

Well, I think that it would depend upon a number of circumstances, but I think that one could go up to at least ten stories.

Mayes:

I've just performed a set of calculations for a frame building and I am just going through a similar set of calculations for a load bearing shear wall building. Both of these indicate that large forces are required and the forces appear to be too large to be produced by portable equipment that is presently available.

Fintel, Portland Cement Association:

Dick, [Gensert] regarding your comment on coupled shear walls in which you came up with reinforcement starting only from the second floor, we have recently carried out dynamic inelastic response studies (time history studies) of coupled shear walls and we have found that in a 16-story coupled shear wall we had quite substantial tensile forces reaching a number of stories high, which would actually require quite a bit of reinforcement in the coupled shear wall. Obviously, when you used the code forces you came up with no tensile forces. However, dynamic response studies show that tensile forces do exist.

Gensert:

Right, this was the study.

Self, University of Florida:

I'm wondering if anyone has heard of trying or if it's ever been proposed to use controlled demolition. I've seen some very spectacular use of controlled demolition and of high speed photography in observing the failure and collapse of buildings; and it seems to me that it was a waste to simply destroy many buildings that are up to 15 stories high by controlled demolition without making any kind of study on the structure or on the collapse mechanism.

Gensert:

We haven't done anything on that line although we've looked into the Hough area in Cleveland where we have a lot of abandoned buildings; many of them are masonry. There's been some talk going on with the city regarding the possibility of some kinds of tests on them. The testing of the actual buildings that I referred to is not only for dynamic but also for static distribution of stresses. We do have a building in Wheeling, West Virginia, that's been instrumented right now to determine what happens with composite walls; what happens with the loads coming at one point of a wall; and how the stress is distributed through the wall. We hope to have some results on that within a year's time.

Hegemier:

Dick, [Gensert] I don't want to press this point to oblivion here but, I guess the thing that concerns me is that I believe with enough effort one can conduct a test on either a semi-full-scale building or a full-scale building. You evidently have a building in mind--a certain structural type. But, what do you conclude, then, about another building where the structural design is quite different? Once you've conducted the test in the manner in which you want to conduct the test, do you think that you can say something about other buildings? In other words, you're working from the top down, in essence, here.

Gensert:

Well, I think our particular interest is not a fully reinforced building like you experience on the West Coast. What we're looking for is one that's partially reinforced which would be typical of, say, the Midwest and the East Coast and many parts of the South. The type of building we're talking about has minimal reinforcing and probably has a lot more slippage between floor slab and wall than the kind you would have; so it's not a tightly bound reinforced structure; it's one that has many loose parts and one that we're rather concerned about just as our code man in Detroit is.

Clough, University of California, Berkeley:

I'd like to respond to Gill [Hegemier] rather than to Dick [Gensert] because we've had several years of experience with rotating mass shakers at Berkeley, testing many kinds of structures. The rotating mass shaker is an extremely good tool for studying the elastic performance of structures and the problems of instrumentation that you mentioned are not particularly severe. I don't think that the CAL TECH experience in the Millikan Library is a negative one in any sense. I think that's been an extremely effective investigation and typical of what can be done in that kind of full-scale experiment. The value of these experiments is in proving or disproving the validity of the mathematical model that one would choose to represent that system in calculation of any kind of structure. If you can mathematically model Millikan Library, you should be able to mathematically model reinforced concrete shear wall structures of different configurations. The real difficulty in field measurement is, as Ron [Mayes] was implying, when you get beyond the elastic limit level and the difficulty with the portable equipment is that there's simply not enough power in it. As soon as you begin causing damage, the power requirements are fantastically large. In the elastic range you can develop forces which are quite severe; you can produce large deflections; no problems develop in the testing until something begins to go wrong. But as soon as you begin to break down the structure, the energy demand exceeds the capacity of the equipment and you simply can't even damage very, very small buildings. We made tests on single-story wooden school buildings in California; can't produce any damage even though, in principle, the forces that are developed are large enough. You simply can't produce the energy input which is required to cause any significant measurable damage. I think if you are only interested in the elastic range of performance, full-scale field measurements are very, very valuable. But to do the damage type testing, as Ron [Mayes] indicated, they've developed much more powerful equipment and I'm still rather skeptical about the amount of damage that they're going to be able to develop in the tests that they're going to start this week.

Gensert:

I have one comment. That is exactly what we are looking for--the elastic behavior. We'd also, then, like to compare it with the micro-testing that's been conducted by these little portable machines that measure ambient motions that go through the structure to see whether that technique has any validity to it.

Mayes:

I'd like to make one comment about testing in general with respect to seismic behavior and I think we have to keep this in mind throughout. We're talking about seismic loads; and seismic loading is a cyclic type of loading. We have to be very careful when we look at static results or blast loadings on a wall and try to interpret that data with respect to a seismic load because a seismic load is an alternating load and the failure mechanisms and the behavior are quite different from an uniaxial or a monotonic type loading. So, throughout our discussions, as we move into the Working Groups, when you're looking at these data you just have to be very careful as you interpret this with respect to seismic type loadings. I think in all of our recommendations for future research we must be looking at cyclic type loadings. I think that for a uniform test that we might want to use to determine shear strength, we could be looking at a monotonic type test such as a Blume test for determining the ultimate strength; but for determining the actual behavior of masonry components for seismic loadings, it has to be cyclic. This is not being made clear, and I'd just like to make that point clear before we move on.

Questioner:

Dick, I wonder if you'd comment in terms of any of the buildings that you have designed in Seismic Zones that are rated 2 or higher, or whether, at any point, there is a coming together of considerations for progressive collapse and seismic loading where the reinforcing requirements for one would drop off and the other would begin to control. I'm concerned about Ron Mayes' question, because he makes it sound as if there is no connection, but I have a gut feeling from the way we would want to go about our design, that there is indeed a connection between the two.

Gensert:

Well, not having experience in progressive collapse I'm not sure that I can offer much of an answer. In the type of static seismic analysis that we go through and the ductility requirements that we're looking for (that's our concern more so than seismic) we end up with reinforcing steel at the end of each wall; and because we want to tie walls together, we also have reinforcing steel at a floor line. This, then creates, let's say, a reinforced masonry frame. Now if by progressive collapse you blow out the center of the bearing wall, between the arching action of the masonry and the reinforcing that you get as a result of the seismic and ductility requirements, you probably get a structure that would stand up against progressive collapse.

Crist, National Bureau of Standards:

I can answer with some things that I've heard other consultants say about this. I've talked to consultants in the UK and maybe Bill Cranston can help me on this. They've made some comparisons of Zones 2 and 3 of the UBC versus their progressive collapse criteria and found that they could meet the alternate path progressive collapse criteria using the reinforcing requirements in Zones 2 and 3. Now that's a pretty broad-brush statement but it was one of their rules of thumb in one of the consulting offices. Bill [Cranston], have you heard any reflections on that sort of thing?

Cranston, British Cement and Concrete Association:

Well, I have in my brief case the latest draft of the masonry code. What's going to happen to it when it goes to the committee on October 4th, I don't know, but I've got a few nasty question marks for my input. The key thing that's gone in is just a basic statement for buildings up to four stories: that you should, in fact, build them robustly and you should have regard to the planned form (which is, as somebody was saying, that if you just architecture it properly, for the same money, you'll get a decent building). It still has to be designed for 1 1/2% G. We haven't any earthquakes at all, but we've said that it has to be designed for 1 1/2% G. That, I think, seems to be getting up towards between Zones 1 and 2 according to the rough

counts I've done. I don't know whether I'm right yet. Now, when you go over five stories, we're talking of putting tie forces in. Now, I can't say whether these tie forces would be, in any way, the same ball park figures for Zones 2 and 3. I think they probably are not. The ties go into very specific places, along the floors, certainly tying the floors together which means you can only lose a certain part of the building anyway.

Fintel:

Our initial looking into progressive collapse requirements showed that whatever is reinforced for Zones 2 and 3 is obviously sufficient for progressive collapse. However, the other way around, if it's only moderately reinforced for progressive collapse, it would not be sufficient for Zones 2 and 3 earthquakes.

Webb, Department of Health, Education, and Welfare:

I would like to make a statement rather than ask a question. We have a concern regarding hospital construction and the dual earthquake problem - the maximum probable event that might occur once within a certain life period (say forty or fifty years) versus the maximum credible event or event that might occur in say a 100 year interval.

We would like for the structure to remain within the elastic range of response for the probable event; however, under the credible event the structure may deform to the point of strain hardening but, hopefully, not to collapse with consequential loss of life. Now, with regard to research, when it comes to the practicing AEs, they often say "We cannot compute the stiffness of the structure for there are too many factors involved. Therefore, what's the use of going through a lot of computations to determine strain or displacement ranges if we cannot take into account the effect of stairwells, exterior cladding, etc., that contribute to the stiffness or degree of displacement? When it come to shear walls, there are six to ten different analytic methods in use and there is indeed a wide gap in comparison of the answers one gets by use of the different methods." Therefore, with regard to prototype testing within the range of elastic response, I feel that for important structures there may be much information to be obtained. I would hate to see the potential for obtaining information through prototype testing be killed by a group such as we are, here today.

* * * *

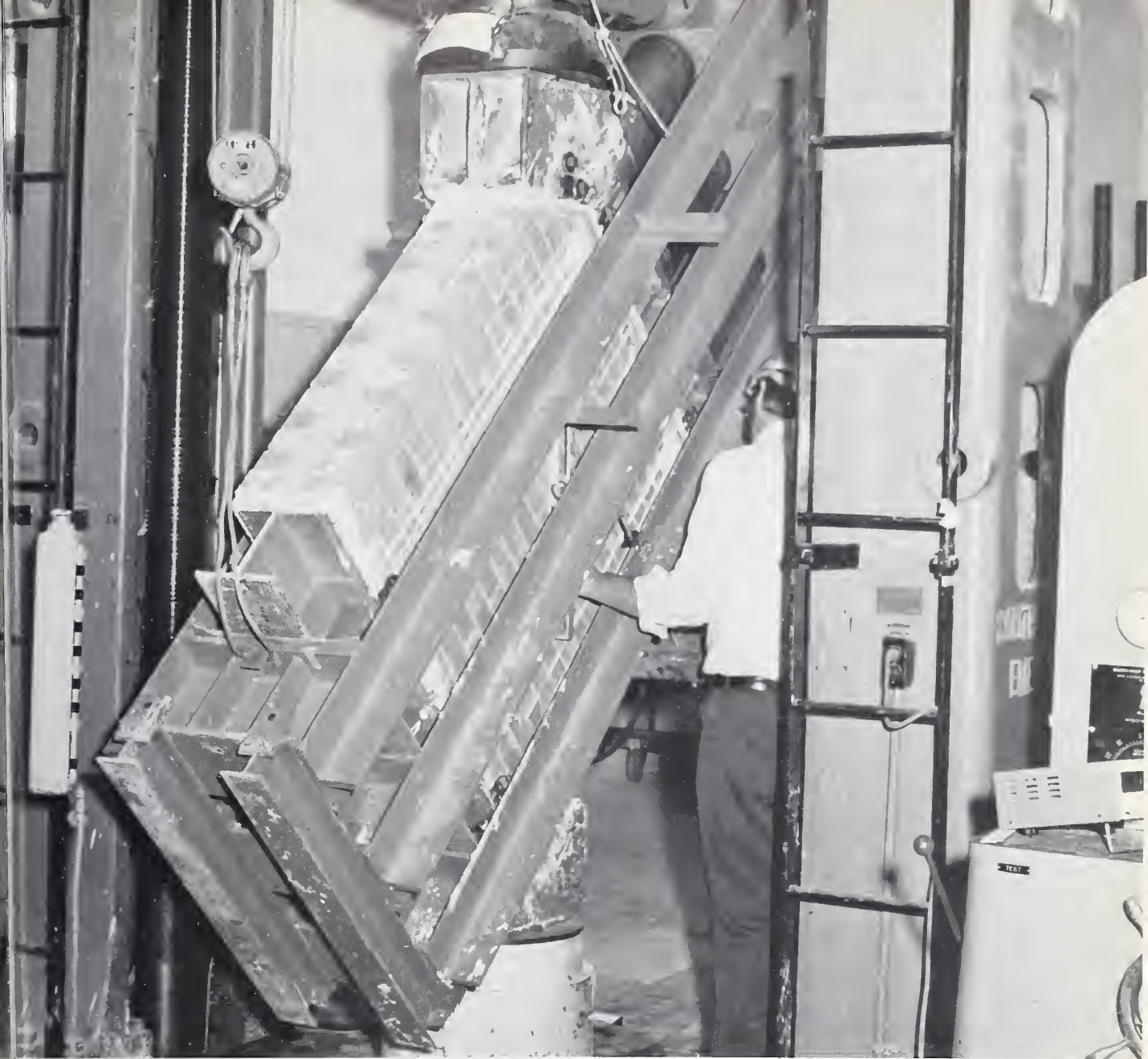

2. RECOMMENDATIONS OF WORKSHOP

The recommendations contained herein represent the consensus of the participants in the Workshop but do not constitute an individual endorsement by any participant or his organization. Membership in the Working Groups was by prioritized preferences indicated by the invitees before the Workshop. Each group was presented with a work statement to serve as a basis in formulating its critical review of current research and recommendations for future studies. The groups were also requested to provide assessments of the state-of-the-art of designing earthquake resistant masonry buildings and of user (building designer) needs.

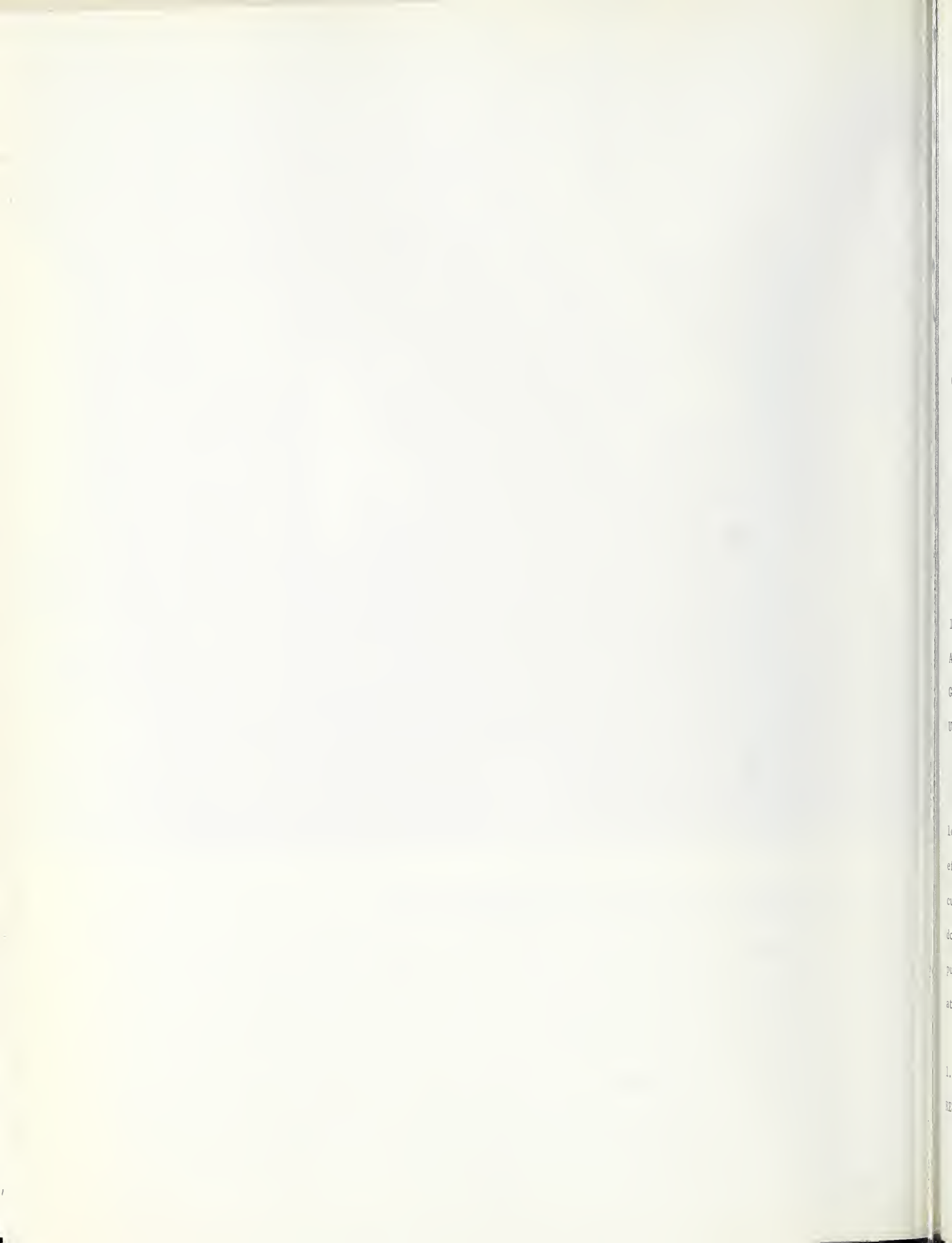

I
A
G
U
l
e
c
t
u
r
e
p
u
b
l
i
c
a
t
i
o
n
e
s

1. Code Requirements

Work Statement - From an assessment of codes and standards for deficiencies in requirements for earthquake resistant masonry construction, recommend needed research to alleviate these deficiencies. In addition, this committee should recommend revision of codes and standards which they feel would foster improvement. Another element of this group's output should be the assessment of how the results of research should be incorporated into codes and standards and recommendations for improving the process.

Committee:

Culver, C., Chairman	Stoppelman, L.
Meehan J., Co-Chairman	Tyrell, J.
Hildebrandt, R.	Wakefield, D.
Lederer, C.	Werner, M.
Mayes, R.	

1.1 A COMMON BASIS SHOULD BE ESTABLISHED FOR EVALUATING THE NATURE AND MAGNITUDE OF RISK ASSOCIATED WITH EARTHQUAKES THROUGHOUT THE U.S. AND ARTICULATED IN A FORM SUITABLE FOR GUIDANCE IN REACHING POLICY DECISIONS. AN EARTHQUAKE ZONE MAP SHOULD BE MADE EASILY UNDERSTOOD, WITH THE RISKS EXPLAINED.

Model codes, political jurisdictions, and federal agencies do not agree on the earthquake loading to be used in many locations. Thus, public acceptance is lacking and formulation of effective policy for design of new facilities or evaluation of existing buildings is difficult. The basis for earthquake loading must be clearly stated and supporting data documented. Earthquake risk should be stated in a way that makes it understandable to the public, to building officials and to professional designers. The objective of this evaluation is development of a seismic risk map that will be widely understood and accepted.

1.2 THE BASIS OF MODEL CODE REQUIREMENTS FOR THE SEISMIC DESIGN OF MASONRY SHOULD BE REVIEWED TO IDENTIFY THOSE AREAS REQUIRING ADDITIONAL RESEARCH.

Existing design requirements for masonry which are empirical standards based on judgments of actual performance of structures have evolved from rules of accepted practice and limited analytical or experimental data. In many cases, the basis for these requirements is unclear or appears arbitrary and their applicability to current construction practices has been questioned. Requirements for the minimum amount of reinforcing steel, height-to-thickness limitations and minimum wall thickness are examples. Evaluation of the rationale used in developing these requirements will identify those areas for which additional research is required to establish rational consistent code provisions. Existing buildings that have withstood seismic action should be investigated to determine the factors which contributed to their successful structural resistive capacities.

1.3 EARTHQUAKE RESISTANT DESIGN PRACTICES AND CONSTRUCTION REQUIREMENTS FOR MASONRY SHOULD BE CLEARLY ESTABLISHED FOR EACH EARTHQUAKE ZONE ESTABLISHED IN THE CODES.

Currently the arbitrary minimum design and construction details do not sufficiently recognize the variability of the relative hazards between the different seismic zones. Such minimum requirements for each zone should be clearly recognized and established in the code.

1.4 INVESTIGATE, IDENTIFY AND DOCUMENT SPECIFIC CHARACTERISTICS OF MASONRY CONSTRUCTION WHICH HAVE DEMONSTRATED A NEED FOR IMPROVEMENT AND/OR CLARIFICATION IN ORDER TO BE MORE ACCEPTABLE FOR USE IN LATERAL FORCE RESISTANCE.

The feeling exists, among designers and code officials, that not enough is known about unit masonry to generate greater confidence in its use in resisting seismic or other lateral forces. This study is needed to determine if such feeling is founded upon reality or simply intuition, and in turn, to verify any real need for specific research and code revision.

1.5 ACKNOWLEDGE PRACTICAL ALTERNATIVES TO MEETING NEW CONSTRUCTION REQUIREMENTS FOR SEISMIC-RESISTANT MASONRY CONSTRUCTION IN THE EVENT OF INCLUSION OF "RETROFIT" REQUIREMENTS IN BUILDING CODES.

If and when a decision is made to "update" existing structures to meet the seismic requirements of a later code, recognition must be given to the likely possibility that corrective construction cannot follow precisely all requirements imposed in building a new structure. Other practical means of meeting "the intent of the code" must be developed.

1.6 A MECHANISM SHOULD BE ESTABLISHED TO TRANSLATE RESEARCH DATA INTO CODE PROVISIONS OR DESIGN PRACTICE.

Before research data can be used in the design of buildings it must be reviewed for technical acceptability, coordinated and integrated with related information, put into suitable form and publicized. This process should involve researchers, code writers, design professionals, and industry representatives.

1.7 IN DEVELOPING OR UPDATING DESIGN REQUIREMENTS CONSIDERATION SHOULD BE GIVEN TO INSURING COMPATABILITY WITH SEISMIC PROVISIONS.

Design requirements based on seismic considerations may not always be compatible with requirements for fire protection, energy, conservation, etc. To insure consistent reliability in design, compatible requirements must be established.

1.8 DEVELOP A MANUAL OF MASONRY INSPECTION PROCEDURES FOR SEISMIC CONSTRUCTION.

Currently some codes do not recognize or stress the importance of certain construction-detail procedures or techniques required to achieve the desired end result in masonry construction. Codes, standards, circulars, directives or other comparable vehicles should be re-evaluated or developed in order to establish clearly the best construction procedures and techniques to be employed for all forms of masonry construction. For example, the need for clean concrete construction joints for adequate bond between successive grout lifts, and between grout and masonry units; the acceptable size of the large aggregate relative to the available grout space; the need for cleaning the grout space of mortar projections; the moisture content of the grout; the consolidation procedures and timing relative to tempera-

ture and moisture content of the brick or block; and many other items of comparable importance to achieve competent uncracked wall bonded grout should be established and defined. This information is critically needed for the inspector and contractor.

1.9 QUALITY CONTROL PROCEDURES AND MECHANISMS FOR MATERIALS AND ASSEMBLAGES SHOULD BE RE-EVALUATED FOR THEIR ENFORCEMENT.

It is felt that there is a need for better quality control because present procedures and enforcement are inadequate.

1.10 A SMALL-SCALE FIELD TESTING PROCEDURE SHOULD BE DEVELOPED THAT PROPERLY CORRELATES WITH THE COMPRESSION, TENSION, SHEAR AND BOND STRENGTHS OF FULL-SCALE BUILDING ELEMENTS.

The current practices of correlating the results of prism tests with prototype shear, bond & tension strengths are not valid. Test methods must be developed to realistically evaluate the tension, shear and bond strengths of small test specimens. These small test specimens must correlate with corresponding tests on full scale building elements. The small test specimens must be compatible with available commercial testing laboratory equipment.

1.11 THE FEASIBILITY OF INCORPORATING LIMIT STATE DESIGN FOR MASONRY IN CODES SHOULD BE INVESTIGATED.

This statement presumes that limit state design is a valid design approach and should be investigated for possible inclusion in the codes.

1.12 OBSERVATION OR SUPERVISION OF CONSTRUCTION BY THE DESIGN ENGINEER SHOULD BE REQUIRED.

It is felt to be good construction practice to require the engineer responsible for the design to visit the job site periodically to observe for himself that the construction is in accordance with his design.

1.13 ALL FUTURE MASONRY CODES AND THEIR CHANGES SHOULD BE ACCOMPANIED BY WRITTEN COMMENTARIES.

It is the responsibility of the code change authority to explain, justify code changes and make them available to the people who use them. Code changes should be fully explained in an accompanying document so that users can consider the validity of the requirements.

1.14 RESEARCH DATA IN MANY FACETS OF SEISMIC MASONRY DESIGN SHOULD BE DEVELOPED TO FORMULATE A MORE CREDIBLE APPROACH TO SUCH DESIGN.

Further research is needed on the following subjects:

- 1) Reinforcement requirements in masonry shear walls in terms of direction, size and minimum amount allowable.
- 2) Anchorage requirements and performance of bolts, connections and hangers. (Allowable loads, edge and end distances, spacings, and grout coverage should be evaluated.)
- 3) Ultimate strengths of masonry structural assemblages under static and cyclic loading.
- 4) Requirements pertaining to height-to-thickness ratios.
- 5) Roof diaphragm-shear wall connections.
- 6) Coupling and spandrel beams.
- 7) Reinforcement bond strengths and embedment requirements.
- 8) Floor slab-shear wall connections.
- 9) Proper splicing and placement of reinforcement.
- 10) Damping in masonry buildings.
- 11) Reducing vertical shrinkage cracks in concrete masonry walls.
- 12) Stack bond masonry performance.
- 13) Study effects of vertical acceleration and necessity for code requirements.
- 14) The possible need for separate code allowable forces for different materials (e.g. hollow clay, brick, concrete block, composite etc.)
- 15) Methods to eliminate concrete block face shell bond failures.

2. Design Criteria

Work Statement - Assimilate and synthesize available information and knowledge to make recommendations for needed research to develop advanced design criteria; for instance, limit state design criteria.

Committee:

Crist, R., Chairman	Fintel, M.
Gensert, R., Co-Chairman	Hegemier, G.
Amrhein, J.,	Self, M.
Cole, E.	Webb, R.
Cranston, W.	

THIS A LIST OF TOPICS REQUIRED BY THE DESIGN ENGINEER TO ACHIEVE EARTHQUAKE RESISTANCE OF MASONRY STRUCTURES. CONSIDERATION SHOULD BE GIVEN TO SIMPLICITY OF APPLICATION. SOME ITEMS MAY REQUIRE RESEARCH, AFTER WHICH DESIGN PROCEDURES CAN BE ESTABLISHED. THESE CRITERIA SHOULD ADDRESS THEMSELVES TO RISK AND SERVICEABILITY WITH THE ASSURANCE OF REDUNDANCY THROUGH THE INCORPORATION OF BACK-UP SYSTEMS.

Designer's Viewpoint

2.1 Loads restricted to seismic

Select load criteria through following steps:

1. Static
2. Spectrum including risk
3. Time history
4. Influence of variability of structures, materials, and workmanship in design criteria

2.2 Masonry structural systems

1. Shear walls
2. Connections
3. Veneers

- 4. Partitions
- 5. Curtain walls

2.3 Structural response

2.4 Proportioning of elements

2.5 Iteration

2.6 Detailing

* * * * *

2.2.1 Shear Walls, Piers, Beams

Consideration for in-plane and out-of-plane forces

- a. Strength: Compression capacity with various l/d ratios
 Flexural capacity in cyclic loading in presence of variable
 vertical loads
 Shear capacity in cyclic loading in presence of variable
 vertical loads
- b. Stiffness: Initial elastic flexural and shear stiffness due to monotonic
 and to dynamic loads (cyclic loading)
 Post-yielding inelastic flexural shear stiffness due to
 dynamic loads (cyclic loading)
 Configuration or geometry of walls and proportions including
 coupling of walls
 Properties of constituents
 Masonry units
 Reinforcement (both quantity and placement)
 Grout
 Mortar
 Diaphragm connection stiffness

- c. Ductility: Loading or path dependence
 - Load-deflection defining structural response
 - Application relative to seismic intensity
 - Ductility demands are localized
 - Time-rate effects
 - Determination of minimum and maximum reinforcement ratios with respect to force levels

- d. Damping: Constituents
 - Geometry or shape
 - Reinforcement patterns
 - Low, medium and high amplitudes

- e. Performance of unreinforced masonry for low seismic risk areas

2.2.2 Connections of Horizontal and Vertical Elements (Designer)

- a. Walls and diaphragms
- b. Flanged walls
- c. Abutting walls

2.2.2.1 Consideration of stress

- a. Shear transfer
- b. Vertical load transfer
- c. Moment transfer
- d. Ductility

2.2.2.2 Connections of appurtenances

- a. Veneers
- b. Partitions
- c. Curtain walls
- d. Parapets

2.2.2.3 Consideration of details

- a. Bolts
- b. Laps
- c. Keyways
- d. Dowels
- e. Anchorages
- f. Isolation requirements

* * * * *

2.7 Definitions

1. Working stress design -

Design analysis based on elastic behavior, and proportioning at different stress levels

2. Ultimate strength design -

Design analysis based on strength

3. Limit design -

Redistribution of stress at point of yielding of materials

4. Limit state design -

Design for performance by setting different load limits to establish areas for safety and serviceability of structure

5. Ductility -

Relationship of elastic deformation relative to inelastic deformation

6. Damping -

As related to velocities and displacements

3. Mathematical Models

Work Statement - Based on the assessment of current and past masonry research, recommend needed research to develop analytical procedure, models and techniques to design simple elements and whole buildings. Also provide recommendations on the use of mathematical models as a research tool. Identify research needed to create simplified analytical models that designers can use without the aid of computers.

Committee:

Leyendecker, E., Chairman

Isenberg, J.

Agbabian, M., Co-Chairman

Clough, R.

Brown, R.

Krishnamoorthy, G.

3.1 OBJECTIVE

PREDICT STRUCTURAL RESPONSE DUE TO A GIVEN EARTHQUAKE INPUT WHICH CAN BE USED TO DETERMINE LEVELS OF DAMAGE IN CRITICAL PORTIONS OF A MASONRY STRUCTURE.

3.2 APPROACH

DEVELOP A MATHEMATICAL MODEL (AS DESCRIBED BELOW). THE MODEL WILL SERVE AS THE BASIS FOR PREDICTING RESPONSE AND IN IDENTIFICATION OF NEEDED RESEARCH INCLUDING NECESSARY EXPERIMENTAL PROGRAMS. THE MATHEMATICAL MODEL WILL SERVE THREE PURPOSES:

- 1) A research tool for understanding structural behavior
- 2) A design verification tool
- 3) A basis for developing simple models that may be used by designers

Both short term and long term objectives can be identified:

Short term - Develop a 3-dimensional nonlinear mathematical model to meet the above 3 purposes incorporating nonlinear (hysteretic) behavior and using a deterministic approach.

Long term - Develop a mathematical model for design optimization using a probabilistic approach based on experimental data.

3.3 MATHEMATICAL MODEL - Steps in accomplishing the goal.

The mathematical model is intended to simulate the earthquake response behavior of a real masonry building. Just as the actual structure is constructed by assembling masonry units, mortar and reinforcing bars, the mathematical model is formulated by assembling mathematical descriptions of the behavior of individual structural elements starting from the smallest units and building into successively larger substructures. The several stages of the assembly process which are considered appropriate in formulating the masonry building analysis program are shown on the diagram in Figure 1.

Macro elements are viewed as the basic unit of the mathematical model. The properties of these units are detailed in terms of multiaxial stress strain relations obtained from experiments in which strains are approximately uniform and homogeneous in the specimens. The method of formulating these constitutive equations is yet to be determined. However, the scheme selected should afford mathematical guarantees of uniqueness, continuity and stability. Elastic, non-ideally plastic and endochronic models meet these requirements. The ability to represent hysteresis during cyclic loading is essential.

The objective of studying masonry components at the micro level (block, grout, rebar, mortar) which is also shown in the diagram is to understand stress/strain properties of the constituent materials.

It is not expected that this information will be used in constructing properties at more complex structural levels. Instead, we recommend some simple studies of these materials as an aid to basic understanding of masonry which will influence needed development in indirect ways.

An assemblage of macro elements is a structural component. Examples are shear walls, piers, spandrels, beams, columns, arches and infills. These components develop non-uniform stress and strain distribution during seismic response of a structure due to their geometry and the manner in which they are loaded (boundary conditions). Mathematical models of

Mathematical Model

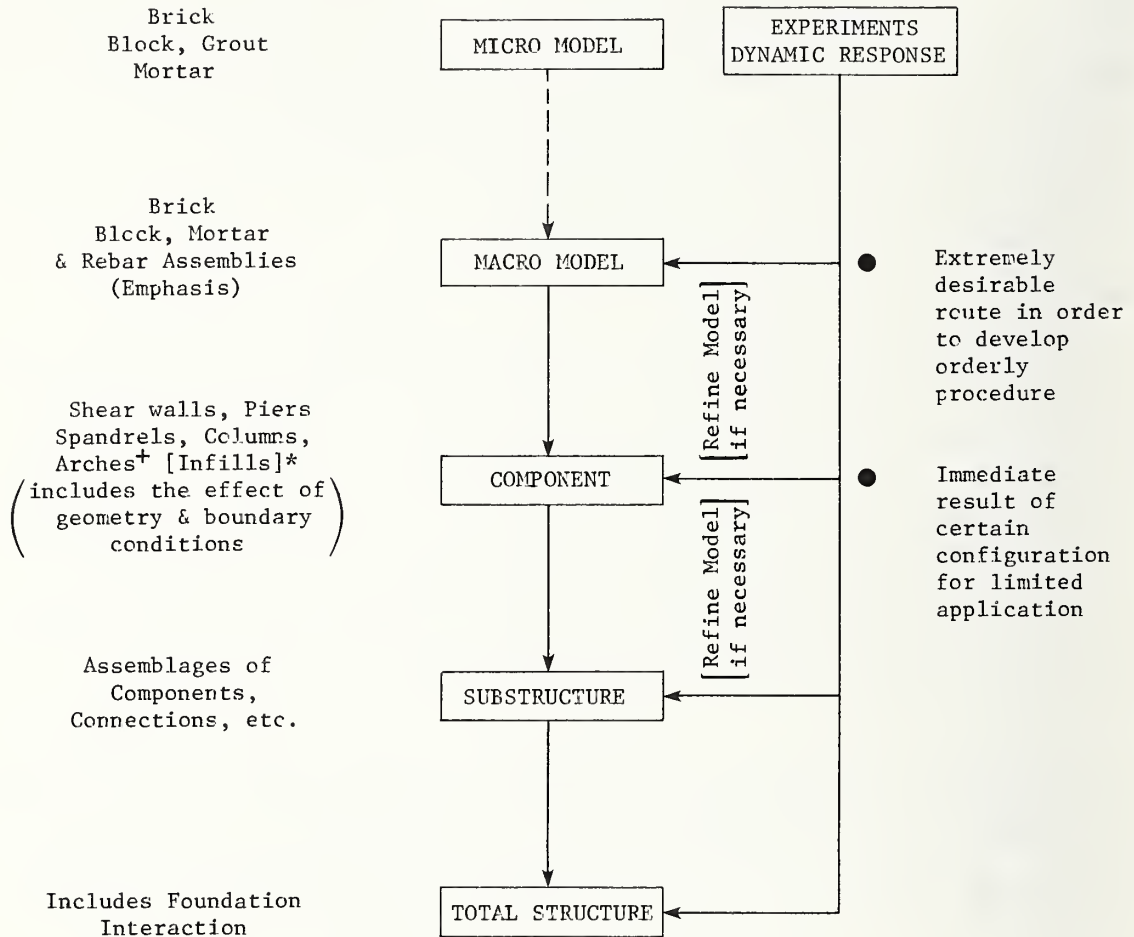

- Points of Entry for tests
- + Lowest priority
- * Will not be included in the masonry program

Note: Connections should include Beam & Joist Connections to Walls, Pilasters etc., such as in a one-story industrial or school building.

Figure 1

structural components will be developed using finite element methods in which the stress - strain properties from the "macro" level are used. The end result of component modeling will be a set of nonlinear force displacement relations at discrete model points.

Structural components are assembled into substructures such as coupled shear walls, flanged shear walls etc. Substructures also include connected components such as floor slabs and shear walls. The finite element representation of generalized force-deflection relations must be extended to include the expanded structural unit. Numerical algorithms for integrating equations of motion at the substructure level may be developed, depending on whether dynamic substructuring is judged to be an efficient method of integrating the equations of motion for the entire structure.

The substructures will finally be assembled into a mathematical model of the entire structure. This will include foundation interaction effects. The final model will be three-dimensional, dynamic and will include complex material nonlinearity. The equations of motion will be integrated by direct-integration methods. The input to this will be specified as a time history of ground motion at the foundation level. Such a model may be used for design verification and as a research tool for understanding structural behavior. Its direct use for design will not be practical. It is therefore recommended that the three-dimensional mathematical model be eventually correlated with full-scale controlled tests of buildings and compared with traditional approximate methods of design. Correlation with full-scale experiments will give the final data for the parameters in the model that would initially be obtained from the experiments involving the macro, component and substructure elements. Comparison with traditional approximate methods of design will improve design procedures and culminate in the development of improved simple models that may be used by designers.

Elements associated with each step of the sequence are:

Micro: Block, grout, mortar, rebar

Macro: Block, mortar, etc., assembled into a masonry unit that resists forces
◦ in-plane and out-of-plane.

Component: Shear walls, piers, spandrel beams, columns, arches, infills (Note: Infills are not included in this research program).

Substructure: Assemblages of components and their connections. These are coupled shear walls, flanged shear walls, floor to end wall connections, interior walls with continuous floor slabs, wall to wall connections, as well as: beam to column connections, beam/joist connection to pilasters, walls. Include substructures that pertain to multistory as well as industrial type structures.

Total structure: It includes foundation interaction.

Note: Elements include concrete block, brick, etc., as used for structural purposes.

Experiments (cyclic and, when necessary, by dynamic simulation) will provide data to develop a mathematical model, as follows:

- 1) Obtain properties of a macro model
- 2) Incorporate these properties in component models in terms of finite elements
- 3) Combine components into substructures by including appropriate models for component connections
- 4) Combine substructures to represent a total structure

In each of the above steps, mathematical models will be developed to describe the behavior of the component/substructure, etc., for the corresponding experimental program. Interactions, as required, will lead to acceptable mathematical models.

4. Test Standardization and Material Properties

Work Statement - Assess the current masonry test procedures and formulate recommendations for needed research for the development of tests of relatively small specimens to provide information on material properties, such as stiffness, shear strength and splitting strength, which are critical in earthquake resistant design. These tests fulfill a function similar to that of "prism tests" (ASTM Designation E 447 and E 518), and should also be capable of:

- (1) determining material properties of various types of masonry construction;
- (2) indicating effects of variables (e.g., strength of units; initial rate of absorption of brick on building component strength; strength versus the various mixes of mortar and grout);
- (3) providing effective construction quality control.

Committee:

Noland, J., Chairman

Lybas, J.

Fattal, G., Co-Chairman

Maurenbrecher, P.

Gabrielsen, B.

Redmond, T.

OBJECTIVE

The objective of Working Group 4 was to recommend research and development to establish, improve, and standardize small-scale tests for providing information on masonry properties so that masonry structures may be more successfully designed and constructed to withstand seismic and other applicable load environments.

INTRODUCTION

Tests for structural materials should provide the designer with information regarding structural characteristics and should preferably be performance oriented. Tests are an important element of the construction process since they verify that the properties of the material actually used are compatible with values used in design. Material tests are also a basic component of research.

However, design, construction, and research of masonry are handicapped because masonry tests presently used do not adequately measure many important masonry structural properties. Further, repeatability and comparability of results are inhibited because of the variability of procedure and/or specimens permitted. The scope and effectiveness of present masonry tests can be improved to provide the designer and researcher with more reliable means of evaluating masonry properties.

THE STANDARD TEST

A standard test is always performed in the same manner on specimens made to the same standards, and the test data is recorded and interpreted in the same way. General criteria established for a standard test are: (1) specimens to be as small as practical for the sake of economy and convenience, (2) the specimen and test procedure be as simple as possible; but within strict guidelines to minimize variability, (3) the results of standard tests be correlated to full-scale masonry behavior for both design, construction, and research purposes, and (4) sufficient specimens be tested to permit statistical analyses so that confidence levels, etc. may be established.

It is not intended that standard tests preclude the use of unique tests for a specific purpose, but rather to provide a broad, common base for general use.

APPROACH

Working Group 4 initially identified the areas of concern to the engineer who is confronted with the task of structural design of masonry to resist seismic and other loads, and areas of concern to the researcher.

The areas of concern are listed below. The topics in Category I have a higher priority than those in Category II. Priorities were based on the immediate need and the potential impact on masonry design and construction.

Category I

- Strength
- Stiffness
- Variability
- Bond of Mortar and Grout to Units
- Reinforcement Bond and Anchorage
- Quality Control
- Evaluation of Existing Structures

Category II

Effects of Cyclic Loading and Loading Rate
on Strength and Stiffness
Movements
Durability

Each of the foregoing topics was discussed with respect to the current test procedures and the need for improvement. The outcome of the discussions is presented in the following summaries.

RECOMMENDATIONS - GENERAL

Research and development needs with respect to standard material tests are presented in the following sections. The following comments apply to all sections.

A critical review of existing or proposed test methods, both in the United States and elsewhere, is recommended to avoid previous unacceptable approaches and to identify any promising concepts. RILEM¹ proposed tests are among the methods which should be examined.

An emphatic recommendation is that standard material tests be an integral part of any test program to establish a common basis for evaluation and utilization of results.

Consider the feasibility of reducing the age of test specimens. This will permit test programs to be shorter and permit quicker evaluation of masonry under construction.

STRENGTH

4.1 DEVELOP STANDARD METHODS TO EVALUATE COMPRESSIVE, SHEAR, AND FLEXURAL STRENGTH

Compressive Strength. Present codes and standards use the ultimate compressive strength as a basis for other strength values as well as stiffness values. While future development should provide more direct means of establishing stiffness and other strength values, compressive strength will always be a fundamental quantity.

Compressive strength is currently established by the prism test or by assumed values for f'_m based upon unit compressive strength and mortar type. The latter method is

¹ Réunion International des Laboratoires d'Essais et de Recherches sur les Matériaux et les Constructions.

meant to give more conservative results than the prism test but in some cases does not; the former is generally recognized as the best current means of obtaining f'_m but is not without its problems.

The standard prism test should be improved. Current procedures can allow excessive variation in results between test programs conducted by different groups. Improvements in prism testing are recommended because they are widely accepted and results of a program could be quickly and readily implemented. Research and development of a more fundamental nature is recommended to permit more accurate values of f'_m to be established based upon the properties of masonry constituents. It would lead to less expensive and more convenient tests for smaller projects and to a more basic understanding of masonry behavior.

A research and development program for prism tests should consider:

- (1) Alignment during construction, capping, and testing.
- (2) Simplify capping as much as possible.
- (3) The influence of end conditions upon test results. This topic should be studied in conjunction with Item (2) above and observing the effect of end conditions on the failure mode.
- (4) Size and slenderness effects with attention to the validity of present h/t correction factors. The influence of the number of mortar joints should be observed to establish the minimum number required in a standard specimen.
- (5) The effect of curing method upon test results should be established to permit a standard method to be adopted whose correlation with curing of full-scale masonry is understood.
- (6) Construction of prisms, i.e., stack bond vs the same bond to be used on the job, and single wythe vs the number of wythes to be

used. Establish the correlation between the different configurations and their correlation to full-scale behavior.

- (7) Testing at specimen ages less than 28 days so that results may be obtained earlier from both laboratory and field built masonry.

A research and development program for constituent tests should consider:

- (1) Investigate capping methods and unit condition (e.g. oven-dried vs soaked) with respect to unit compressive testing. Observe the influence of characteristics, such as IRA, upon unit properties. Investigate other means of establishing unit properties.
- (2) Mortar and grout tests as a measure of their performance in masonry built both in laboratory and in field conditions. The influence of mortar constituents should be considered and methods of measuring the various mortar properties reviewed and improved upon where necessary.
- (3) Prediction of masonry compressive strength based on constituent properties.

Shear Strength. Shear strength as a measure of diagonal tension strength, is one of the basic design parameters in the seismic evaluation of masonry walls most of which function as shear walls under lateral loads. Although the diagonal compression test of 4 foot square specimens presently prescribed by ASTM E-519 provides an effective means of evaluating shear strength of masonry panels, the method has not found wide acceptance primarily because the specimen size required is too large for most test facilities. Rather, existing codes frequently specify shear strength as a function of the square root of f'_m . Recent experimental evidence suggests that masonry strength is related to its tensile as well as its compressive properties. These tests have also shown the feasibility of reducing the size of specimen currently specified by ASTM E-519 without significantly altering the results.

Research recommended in this area includes development of a sufficient experimental data base to permit revision and updating of the present diagonal compression test in the following areas:

- (1) Evaluation of smaller test specimens.
- (2) Expanding the scope of the procedure to include tests of composite masonry specimens.
- (3) Standardization of specimen size and of loading fixtures, capping, loading rates, etc.; and
- (4) Standardized data interpretation.

Modulus of Rupture. The seismic response of masonry is frequently dependent on bond, flexure (in and out-of-plane), direct tension, and flexural shear, which all depend on tensile strength properties. The proper assessment of these properties is a prerequisite in establishing reinforcement requirements. Information is also needed on the flexural behavior of masonry used for exterior cladding and for interior non-bearing partitions.

There are considerable experimental difficulties in determining the true tensile strength of masonry by direct tension tests because minor misalignments and stress concentrations induce excessive variability. Instead, flexural tests on small specimens (e.g. as in the ASTM E-518 test) are being considered as a solution. However, research and development are needed to enhance the procedure, such as:

- (1) Correlation of flexural test results from small specimens with those of full-scale masonry considering size effects and method of loading;
- (2) development of a method for evaluating directional variation of flexural tensile properties in relation to bonding patterns;
- (3) the use of flexural testing as a measure of both tensile bond and shear bond between mortar and unit; and
- (4) capability of evaluating composite masonry.

STIFFNESS

4.2 DEVELOP STANDARD METHODS FOR STIFFNESS PROPERTIES

Since both the magnitude and distribution of earthquake-induced forces on the individual elements of a building are stiffness dependent, stiffness properties of masonry are important in the design of seismic resistant structures. The present ASTM E-447 procedure for evaluating the modulus of elasticity could introduce excessive variability between results obtained by different test programs because it is not sufficiently specific. Additionally, many masonry standards permit the elastic and shear modulus to be determined using linear relationships between the modulus and f'_m which have been observed to be inaccurate. Neither of the foregoing establishes the elastic modulus in both orthogonal directions.

It is recommended that:

- (1) Current methods for determining the elastic modulus be critically evaluated and modified or replaced, to provide a method which will reliably and consistently permit E to be determined in directions both normal and parallel to the bed joints. This test should be combined with the standard compression test, if practical.
- (2) An effective test method be developed for evaluating shear modulus using small specimens such as the square specimen used for the determination of shear strength.

VARIABILITY

4.3 EVALUATE VARIABILITY AS IT AFFECTS DESIGN VALUES AND THE NUMBER OF TEST SPECIMENS REQUIRED

Masonry properties used in structural design should be associated with a relatively high degree of confidence that they will be achieved during construction. The various masonry structural characteristics exhibit variability; the degree of variability is usually different for each of the characteristics observed. This is mainly due to the relatively brittle behavior of masonry and partly to a lack of sensitivity in the test and measurement techniques.

In order for factors of safety to be established, the variation of the critical masonry structural properties must be known. Research and development is therefore suggested to:

- (1) Decide on the number of specimens for each of the standard tests, and methods of statistical analysis. Efficiency and economy dictate that the number be as small as possible consistent with statistical significance. Due to the different variabilities, different tests will require different numbers of specimens.
- (2) Correlate the variability of properties of small-scale specimens with that of full-scale masonry. This is necessary to establish scale effects and will influence factor of safety decisions.

BOND OF UNITS TO MORTAR OR GROUT

4.4 DEVELOP STANDARD METHODS TO EVALUATE BOND BETWEEN MORTAR/GROUT AND MASONRY UNITS

Bond, both in shear and tension, between masonry units and mortar or grout is necessary for composite structural behavior.

Current procedures for evaluating tension and shear bond of mortar are unsatisfactory in that extraneous factors are introduced and the specimen and test method do not appear to be sufficiently sensitive. No recognized method is available to establish the bond strength of grout to masonry units.

Research and development are recommended, therefore, leading to standard methods of evaluating bond which investigate:

- (1) the influence of unit properties, e.g.,
IRA, 24-hour absorption, texture, f'_b , and moisture content, and
- (2) the influence of mortar/grout properties, e.g.
cement:lime:sand:water content, retentivity,
workability, and compressive strength.

A standard means for evaluating and understanding shrinkage of grout is also needed. This is of importance with respect to developing composite behavior in grouted masonry.

REINFORCEMENT BOND AND ANCHORAGE

4.5 IMPROVED KNOWLEDGE IS REQUIRED REGARDING THE NATURE OF BOND BETWEEN REINFORCEMENT AND ANCHORAGE TO MORTAR AND GROUT.

Information regarding the bond between mortar/grout and reinforcement/anchorage is necessary. Currently, much has been borrowed from reinforced concrete practice, however, the bond properties of mortar and grout used for masonry construction may be different. For example, development lengths derived for reinforced concrete may not be reliable for reinforcement placed in mortar or grout. The complex stress distributions in the region of hooks, bends, bolts, and inserts or ties, contribute to a poor understanding of the effectiveness of such details. This has been illustrated by failures due to earthquakes.

Research and development are recommended to obtain desirable sizes, types, configuration, placement, etc. of reinforcement, anchorage, and connections, and to develop test procedures for evaluating bond.

QUALITY CONTROL

4.6 IMPROVE THE UNIAXIAL COMPRESSIVE TEST OF MORTAR AND GROUT AS A QUALITY CONTROL PROCEDURE.

While the uniaxial compressive strength of a mortar or a grout specimen is not a measure of its strength as a component of masonry, it is a means of establishing the relative strength of field mixed material to a value established under controlled conditions for a given mix.

The uniaxial compressive test of mortar or grout specimens is currently fairly general practice both as a means of classification and as a quality control procedure. The uniaxial compressive test, properly utilized, can be an effective quality control mechanism, however, lack of reasonably rigorous and standardized procedures, lack of a single standardized specimen in the case of mortar, and lack of a comprehensive data base inhibits the use of the uniaxial compressive test for quality control purposes. Indeed, erroneous or excessively variable results from tests of field made material and/or erroneous interpretation have caused unnecessary delay in several projects.

It is suggested, therefore, that work be done leading to standardization of the type of specimens used, to prescribe a simple, but strictly observed manner in which both field and laboratory specimens are made, cured, handled, and tested, and to establish reasonable acceptance standards.

QUALITY CONTROL

4.7 ESTABLISH THE CORRELATION BETWEEN COMPRESSION TEST RESULTS OF LABORATORY-MADE SPECIMENS AND FIELD-MADE SPECIMENS.

Currently, many design values and moduli are based upon f'_m as determined by the prism test. Hence, f'_m of field-made prisms is a significant indicator of the quality of masonry. The usefulness of the prism test for both design and quality control purposes would be enhanced if the correlation between results of tests on prisms made under controlled conditions and those made in the field was known. Results should include stiffness measurements as well as f'_m since correlation between f'_m and stiffness is poor. Such knowledge would enable design values to be realistically set and realistic acceptance standards to be established for a given project.

Work in this area should cover a range of parameters, e.g. unit type, mortar type, site conditions, and type of structure.

QUALITY CONTROL

4.8 INVESTIGATE THE FEASIBILITY OF MODULUS OF RUPTURE AND DIAGONAL COMPRESSION TESTS AS QUALITY CONTROL PROCEDURES

For critical structures, structures in potentially severe seismic areas, or subject to other high loading, a more direct control or measure of flexure and shear capability of field-built masonry may be appropriate. It is suggested that development of standardized tests for evaluation of those capabilities as discussed elsewhere in this report be extended to provide for quality control applications. The same general recommendations as for quality control using prisms are applicable.

QUALITY CONTROL

4.9 INVESTIGATE THE FEASIBILITY OF PROPORTIONING FIELD-MIXED MORTAR BY WEIGHT OF INGREDIENTS.

Researchers have noted that for accurate control of mortar properties, the relative proportions of ingredients, i.e. the cement, lime, and sand, must be controlled by weight rather

than by volume. Some mortar properties such as bond have been shown to be fairly sensitive to the proportions of ingredients.

Present field practice prepares mortar by volume batching by methods that are often not precise volume measurements. Even with precise volume measurements, differing densities of the same material can affect mortar properties.

As a step toward overall improvement of masonry construction, it is recommended that the feasibility of weight proportioning of field-made mortar be investigated and that standard procedures be established.

EVALUATION OF EXISTING STRUCTURES

4.10 DEVELOP MEANS FOR STRENGTH AND STIFFNESS EVALUATION OF EXISTING MASONRY STRUCTURES.

Cost of new construction and the need for conservation has forced increased attention to retrofit and rehabilitation of existing masonry buildings. Retrofit and rehabilitation require that the structural characteristics of existing buildings be established in order to design the modifications required, if any, to provide conformance with current code requirements, particularly seismic.

Research and development are needed to provide means for economically and effectively determining the structural capacity of existing masonry buildings. Emphasis should be placed upon non-destructive methods, but destructive tests of small specimens taken from the structure should also be developed. Procedures developed should:

- (1) provide information on design parameters;
- (2) be relatively inexpensive;
- (3) be capable of implementation by technicians; and
- (4) be applied in a standard manner with standard means of interpretation.

EFFECT OF CYCLIC LOADING AND LOADING RATE ON STRENGTH AND STIFFNESS

4.11 INVESTIGATE THE EFFECT OF CYCLED LOADS AND LOADING RATE ON STRENGTH AND STIFFNESS AND DEVELOP SMALL-SCALE TEST PROCEDURES.

Structures in a seismic environment are subjected to varying loads. Masonry structures designed for such conditions are usually reinforced to provide tensile strength and ductility. Failure is often by progressive deterioration of the masonry.

Rapid loading rates cause an apparent increase in strength and stiffness properties of many materials such as steel and concrete. A similar behavior might be anticipated in masonry. Knowledge of the effects of loading rate could affect design of masonry for seismic conditions since, quite frequently, earthquake motion records exhibit peak amplitudes occurring at a high frequency (hence a high loading rate). Standard tests, to evaluate any apparent strength/stiffness gain for various masonry configurations at these high loading rates, would provide information required to appropriately truncate the amplitudes as is being advocated by the ATC in its spectral approach to seismic analysis.

It is recommended that research and development be conducted to provide small-scale tests to permit cumulative damage and effective changes in strength/stiffness due to cycled load to be assessed. Some aspects to consider are:

- (1) varying loading rates;
- (2) varying load magnitudes;
- (3) effect of load reversal
- (4) load duration.

MOVEMENTS

4.12 IMPROVE MEANS OF PREDICTING MOVEMENTS IN MASONRY STRUCTURES.

Movements due to thermal effects, creep, moisture expansion and shrinkage can induce significant forces in masonry which may cause cracking. There is a lack of easily obtainable information on deformation characteristics for the designer. Some information has been developed, but much remains to be done so that control measures may be more intelligently taken by the designer.

Research needed in this area should be focused on the development of effective experimental techniques to evaluate movements in the various forms of masonry due to temperature, moisture expansion, creep, and shrinkage. Both short-term and long-term behavior should be considered to permit an assessment of stress redistribution in masonry elements and between masonry and other structural elements.

DURABILITY

4.13 IMPROVE MEANS OF PROTECTING REINFORCEMENT AGAINST CORROSION.

Degradation of masonry due to environmental effects could affect its structural capability. Recent experience, however, indicates that deterioration of masonry itself, with the exception of vintage sand-lime mortar, is not a serious problem.

Corrosion of reinforcement, potentially very serious, particularly in seismic areas, is a topic worthy of further study. Research and development are recommended leading to standards treating required cover and other protective measures. The study should consider reinforcement material, method of placement, mortar and grout properties, additives, unit properties, and environmental conditions.

5. Retrofit and Repair*

Work Statement - Assess current methods of repairing buildings that have sustained earthquake damage and recommend needed research to develop new methods of restoring such buildings. In addition, make recommendations for methodology of evaluating and retrofitting existing buildings.

Committee:

Werner, W., Chairman	Sanidas, C.
Yorkdale, A., Co-Chairman	Scalzi, J.
Nadel, E.	Sears, P.
Reid, R.	Szilas, T.

In order to assess and improve on current methods of retrofitting existing masonry buildings for seismic resistance and the repair of those that have sustained earthquake damage, several functional, scientific and socio-economic areas need to be addressed. These considerations include:

- a) Policy: The approach to the non-conforming building inventory and the socio-economic impact of retrofit in relation to the risks involved.
- b) Education: The understanding and implementation of various techniques by architects, engineers and building officials.
- c) Analysis, Design & Evaluation: The methodologies to be employed in ascertaining seismic characteristics and the advancement of the state of the art of evaluative and computational techniques including knowledge of the interactive behavior of structural elements.

*Terms frequently used herein are defined as follows:

Retrofit: The upgrading of existing structures for increased seismic resistance.

Repair: The restoration of structures, or parts thereof, that have sustained damage as a result of seismic excitation.

Rehabilitation: The upgrading of existing structures to extend their useful life, or change their occupancy, without regard to seismic considerations.

- d) Standards: The development of nationally accepted standards for products and procedures.
- e) Information
Dissemination: The transmittal of knowledge to all facets of the building industry engaged in retrofit and repair, in order to identify successful techniques, and learn from past failures.

(A) POLICY

5.1 IT IS RECOMMENDED THAT A NATIONAL POLICY BE ESTABLISHED REGARDING THE LEVEL OF UP-GRADING NEEDED FOR EXISTING BUILDINGS IN SEISMIC REGIONS.

The largest source of potential damage with the resulting loss of lives and property lies in the present inventory of older buildings constructed before building code regulations were adopted or new revisions incorporated to update the codes to current technical knowledge. Research is necessary to establish information and a data base for decision makers with respect to social, economic, political and public considerations.

(B) EDUCATION

5.2 THE ESTABLISHMENT OF EDUCATIONAL PROGRAMS FOR PROFESSIONALS ON RETROFIT FOR INCREASED SEISMIC RESISTANCE AND REPAIR AFTER SEISMIC DAMAGE IS RECOMMENDED.

The practice of design for retrofitting or repairing masonry structures to seismic requirements is relatively new. To extend the knowledge of the art to all parts of the nation it is recommended that educational programs such as workshops, seminars and lectures be developed for all professionals in the field. The programs should be structured to meet the needs and experience of the professional whether they be engineers, architects or code enforcement officials.

Socio-economic effects should be included in the program along with the technical requirements, so that the professionals may better advise their clients and/or their agencies.

5.3 IT IS RECOMMENDED THAT MASONRY SEISMIC TECHNOLOGY PERTAINING TO RETROFIT AND REPAIR BE INCLUDED IN ACADEMIC CURRICULA OF INSTITUTIONS OF HIGHER LEARNING.

There is a definite lack of knowledge on the technology of repair and retrofit of structures. Engineering students are taught how to design new structures. However, they are seldom taught the technology of retrofit and repair. It is suggested that because retrofit and repair are extensions of existing technology, they may readily be included as a part of the existing curricula.

5.4 A SPECIAL SEISMIC INSPECTORS CERTIFICATION PROGRAM WHICH INCLUDES MASONRY SHOULD BE ESTABLISHED TO PROVIDE A HIGHER LEVEL OF COMPETENCE IN THE INSPECTION OF RETROFIT AND REPAIR.

(C) ANALYSIS, DESIGN & EVALUATION

5.5 IT IS RECOMMENDED THAT EXISTING METHODS OF ANALYSIS BE EVALUATED.

Uniform procedures need to be developed for evaluating and rating existing and damaged structures with emphasis on the development of advanced but simplified computational techniques. The evaluation of masonry assemblage strength, before and after seismic activity, needs to be addressed on a priority basis.

5.6 THE INTERACTION OF MASONRY IN-FILL PANELS WITH BUILDING FRAMES WHEN LOADED BY EARTHQUAKE INDUCED FORCES SHOULD BE DETERMINED.

Masonry in-fill walls are not generally considered as structural elements and their presence is usually ignored in structural analysis. Recent evidence (experimental, as well as that derived from post-earthquake observations) indicates significant effects on the behavior of structural frames by masonry in-fills. In-fill walls should be examined with respect to their effect on structural performance, and general guidelines should be developed for evaluations of the effect of the interaction of masonry in-fill with structural frames.

(D) STANDARDS

5.7 IT IS RECOMMENDED THAT RESEARCH BE CONDUCTED TO ESTABLISH STANDARDIZED DESTRUCTIVE AND NON-DESTRUCTIVE TEST METHODS AND PROCEDURES TO DETERMINE THE PHYSICAL PROPERTIES OF IN-PLACE MASONRY.

5.8 CODE WRITING BODIES SHOULD BE ENCOURAGED TO DEVELOP AND PROMULGATE CODE PROVISIONS FOR RETROFIT AND REPAIR OF STRUCTURES FOUND TO BE NOT IN COMPLIANCE WITH EXISTING SEISMIC REQUIREMENTS.

(E) INFORMATION DISSEMINATION

5.9 IT IS RECOMMENDED THAT PROCEDURES BE DEVELOPED TO DOCUMENT, EVALUATE THE EFFECTIVENESS OF, AND DISSEMINATE METHODS USED TO STRENGTHEN BUILDINGS.

Although extensive work has been done in this area, there has been little interchange of information. Need exists for wide dissemination of methods used (unsuccessful as well as successful) to avoid repetitive and redundant research, to make successful methods available, and to avoid excessive cost and inadequate strengthening.

5.10 A LIBRARY OF LITERATURE, REPORTS AND PAPERS ON RETROFIT AND REPAIR SHOULD BE MAINTAINED BY AN APPROPRIATE ORGANIZATION.

5.11 IT IS RECOMMENDED THAT A CENTRAL ORGANIZATION BE IDENTIFIED AS THE ENTITY THAT WILL HAVE THE RESPONSIBILITY TO CERTIFY PRODUCTS USED FOR RETROFIT AND REPAIR.

The certifications can be based on tests performed by the organization in-house or performed by others. The need, however, is to have one central source for the certification of the product, and the encouragement of new product development.

5.12 THERE SHOULD BE DEVELOPED A MANUAL FOR THE INSPECTION OF BUILDINGS TO DETERMINE NEEDED RETROFIT AND REPAIR FOR USE BY CODE ENFORCEMENT OFFICIALS.

The manual should include the inspection procedures used for the retrofitting of the existing structure along with the inspection procedures to be used during the repair process.

List of Participants
Earthquake Resistant Masonry Construction
National Workshop - Boulder, Colorado
September 1976

Dr. M.S. Agbabian
Agbabian Associates
250 N. Nash Street
El Segundo, CA 90245

Mr. James E. Amrhein, P.E.
Director of Engineering
Masonry Institute of America
2550 Beverly Boulevard
Los Angeles, CA 90057

Prof. Russel H. Brown
Dept. of Civil Engineering
University of Houston
Houston, Texas 77004

Prof. Ray W. Clough
Dept. of Civil Engineering
University of California
Berkeley, CA 94720

Mr. Eugene Cole
Structural Engineers Association
of California
6222 Cameo Ct.
Carmichael, CA 95608

Dr. William B. Cranston
Deputy Head, Design Dept.
Cement & Concrete Association
Research Laboratories
Wexham Springs, Slough SL3 6PL
United Kingdom

Dr. Robert A. Crist
Chief, Structures Section
Center for Building Technology, IAT
National Bureau of Standards
Washington, D.C. 20234

Dr. Charles Culver
Disaster Research Coordinator
Office of Housing and Building Technology
Center for Building Technology, IAT
National Bureau of Standards
Washington, D.C. 20234

Dr. S. George Fattal
Structures Section
Center for Building Technology, IAT
National Bureau of Standards
Washington, D.C. 20234

Mr. Mark Fintel
Portland Cement Association
Old Orchard Road
Skokie, IL 60076

Prof. Bernard L. Gabrielsen
Dept. of Civil Engineering
and Applied Mechanics
San Jose State University
San Jose, CA 95190

Mr. Richard M. Gensert
Gensert, Peller, Mancini Associates
718 The Arcade
Cleveland, Ohio 44114

Prof. G.A. Hegemier
Dept. of Applied Mechanics
University of California
San Diego
La Jolla, CA 92307

Mr. R.C. Hildebrandt
Assistant Director
Building Safety Department
341 Municipal Building
251 West Washington
Phoenix, Arizona 85003

Mr. Jeremy Isenberg
Weidlinger Associates
2710 Sand Hill Road
Menlo Park, CA 94025

Prof. G. Krishnamoorthy
Dept. of Civil Engineering
San Diego State University
San Diego, CA 92182

Mr. Creighton C. Lederer, Director
Building and Safety Engineering Dept.
401 City-County Building
Detroit, Michigan 48226

Dr. E.V. Leyendecker
Structures Section
Center for Building Technology, IAT
National Bureau of Standards
Washington, D.C. 20234

Mr. John M. Lybas
U.S. Army Construction Engineering
Research Laboratory
P.O. Box 4005
Champaign, IL 61820

Dr. A.H.P. Maurenbrecher
Building Structures Section
Div. of Building Research
National Research Council
Ottawa K1A OR6
Canada

Prof. Ronald Mayes
Dept. of Civil Engineering
University of California
Berkeley, CA 94720

Mr. John F. Meehan
Principal Structural Engineer
Office of the State Architect
P.O. Box 1079
Sacramento, CA 95805

Mr. Eric Nadel, P.E.
Assistant to the General
Manager for Development
New York City Housing Authority
250 Broadway
New York, N.Y. 10007

Dr. James L. Noland
Atkinson-Noland & Associates
P.O. Box 3611
Boulder, Colorado 80307

Mr. Thomas B. Redmond, P.E.
Director of Technical Services
National Concrete Masonry Association
6845 Elm Street
McLean, VA 22101

Mr. Robert P. Reid
Headquarters
U.S. Air Force (PREES)
Washington, D.C. 20330

Mr. Christ T. Sanidas
Chief Building Official
160 N. Main Street
Room 713
Memphis, Tennessee 38103

Dr. John B. Scalzi
National Science Foundation
Room 1129
1800 G Street N.W.
Washington, D.C. 20550

Mr. Patrick M. Sears
Civil Engineering Service
Veterans Administration
810 Vermont Ave., N.W.
Washington, D.C. 20420

Prof. Morris W. Self
Department of Civil Engineering
University of Florida
Gainesville, Florida 32601

Mr. Louis E. Stoppelman, P.E.
Building Commissioner for
the City of St. Louis
c/o Rm. 426, City Hall
1200 Market Street
St. Louis, Missouri 63103

Mr. Tibor Szilas, P.E.
Construction Management Div.
Public Buildings Service, Region 9
General Services Administration
525 Market St.
San Francisco, CA 94105

Mr. Joe V. Tyrrell
Director
Civil-Structural Division, FAC 045
Department of the Navy
Naval Facilities Engineering Command
200 Stovall Street
Alexandria, VA 22332

Mr. Donald A. Wakefield, P.E.
Interstate Brick Company
9210 South 5200 West - P.O. Box 517
West Jordan, Utah 84084

Mr. Ross M. Webb, P.E.
Office of Facilities Engineering and
Property Management
Office of Federally Assisted Construction
HEW North Building, Room 3025
330 Independence Ave., S.W.
Washington, D.C. 20201

Mr. Michael E. Werner, P.E.
Technical Director
Building Officials & Code Administrators
International, Inc.
1313 East 60th Street
Chicago, IL 60637

Mr. William J. Werner, P.E.
Director, Bldg. Tech. Research Staff
Office of Policy Development and Research
Dept. of Housing and Urban Development
451 7th Street, S.W.
Washington, D.C. 20410

Mr. Alan H. Yorkdale, P.E.
Director of Engineering
and Research
Brick Institute of America
1750 Old Meadow Lane
McLean, VA 22101

U.S. DEPT. OF COMM. BIBLIOGRAPHIC DATA SHEET	1. PUBLICATION OR REPORT NO. NBS BSS 106	2. Gov't Accession No.	3. Recipient's Accession No.
4. TITLE AND SUBTITLE Earthquake Resistant Masonry Construction: National Workshop		5. Publication Date September 1977	
		6. Performing Organization Code	
7. AUTHOR(S) Robert A. Crist and Louis E. Cattaneo, Editors		8. Performing Organ. Report No.	
9. PERFORMING ORGANIZATION NAME AND ADDRESS NATIONAL BUREAU OF STANDARDS DEPARTMENT OF COMMERCE WASHINGTON, D.C. 20234		10. Project/Task/Work Unit No. 4615418	
		11. Contract/Grant No. NSF/ENV 75-20127	
12. Sponsoring Organization Name and Complete Address (Street, City, State, ZIP) The National Science Foundation Research Applied to National Needs Program (RANN) 1800 G Street, N.W. Washington, D.C. 20550		13. Type of Report & Period Covered Final	
		14. Sponsoring Agency Code	
15. SUPPLEMENTARY NOTES Proceedings of a National Workshop held at the National Bureau of Standards, Boulder, Colorado, Sept. 13-16, 1976. Library of Congress Catalog Card Number: 77-600053			
16. ABSTRACT (A 200-word or less factual summary of most significant information. If document includes a significant bibliography or literature survey, mention it here.) The National Workshop on Earthquake Resistant Masonry Construction provided an exchange of information between researchers and practicing engineers for the purpose of orienting pertinent research toward national needs concerning current problems related to design criteria. These proceedings contain the reports presented by researchers and by users of design criteria, as well as transcripts of the discussions which followed the individual presentations. In addition, the proceedings include recommendations which emanated from working sessions held by five working groups of participants. Technical areas covered by the groups were (1) code requirements, (2) design criteria, (3) mathematical models, (4) test standardization and material properties, and (5) retrofit and repair. The recommendations were derived to identify research which would lead to improved output in each of the technical areas in order to benefit national needs.			
17. KEY WORDS (six to twelve entries; alphabetical order; capitalize only the first letter of the first key word unless a proper name; separated by semicolons) Building codes and standards; design criteria; earthquake resistance; masonry construction; seismic design; structural design; structural engineering; structural research.			
18. AVAILABILITY <input checked="" type="checkbox"/> Unlimited <input type="checkbox"/> For Official Distribution. Do Not Release to NTIS <input checked="" type="checkbox"/> Order From Sup. of Doc., U.S. Government Printing Office Washington, D.C. 20402, SD Cat. No. C13/2-106 <input type="checkbox"/> Order From National Technical Information Service (NTIS) Springfield, Virginia 22151		19. SECURITY CLASS (THIS REPORT) UNCLASSIFIED	21. NO. OF PAGES 372
20. SECURITY CLASS (THIS PAGE) UNCLASSIFIED		22. Price	

There's
a new
look
to...

DIMENSIONS

NBS

... the monthly magazine of the National Bureau of Standards. Still featured are special articles of general interest on current topics such as consumer product safety and building technology. In addition, new sections are designed to . . . PROVIDE SCIENTISTS with illustrated discussions of recent technical developments and work in progress . . . INFORM INDUSTRIAL MANAGERS of technology transfer activities in Federal and private labs. . . DESCRIBE TO MANUFACTURERS advances in the field of voluntary and mandatory standards. The new DIMENSIONS/NBS also carries complete listings of upcoming conferences to be held at NBS and reports on all the latest NBS publications, with information on how to order. Finally, each issue carries a page of News Briefs, aimed at keeping scientist and consumer alike up to date on major developments at the Nation's physical sciences and measurement laboratory.

(please detach here)

SUBSCRIPTION ORDER FORM

Enter my Subscription To DIMENSIONS/NBS at \$12.50. Add \$3.15 for foreign mailing. No additional postage is required for mailing within the United States or its possessions. Domestic remittances should be made either by postal money order, express money order, or check. Foreign remittances should be made either by international money order, draft on an American bank, or by UNESCO coupons.

- Remittance Enclosed (Make checks payable to Superintendent of Documents)
- Charge to my Deposit Account No.

Send Subscription to:

NAME-FIRST, LAST		
COMPANY NAME OR ADDITIONAL ADDRESS LINE		
STREET ADDRESS		
CITY	STATE	ZIP CODE

PLEASE PRINT

MAIL ORDER FORM TO:
 Superintendent of Documents
 Government Printing Office
 Washington, D.C. 20402

Waste Heat Management Guidebook

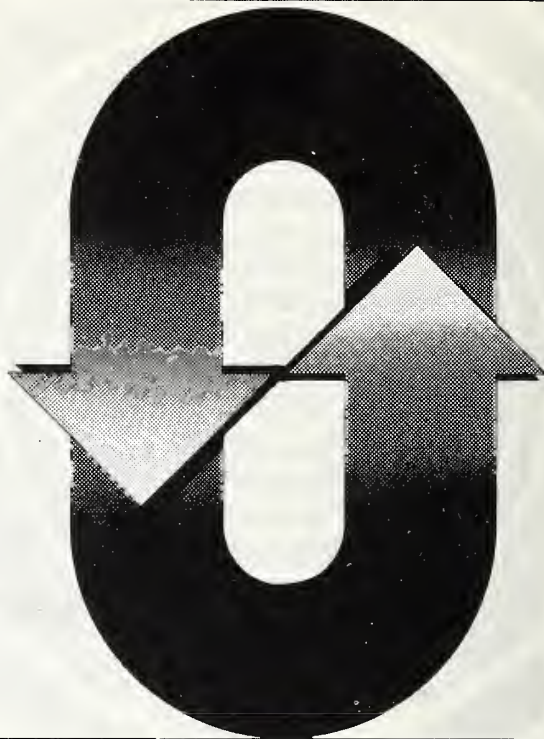

A typical plant can save about 20 percent of its fuel—just by installing waste heat recovery equipment. But with so much equipment on the market, how do you decide what's right for you?

Find the answers to your problems in the *Waste Heat Management Guidebook*, a new handbook from the Commerce Department's National Bureau of Standards and the Federal Energy Administration.

The *Waste Heat Management Guidebook* is designed to help you, the cost-conscious engineer or manager, learn how to capture and recycle heat that is normally lost to the environment during industrial and commercial processes.

The heart of the guidebook is 14 case studies of companies that have recently installed waste heat recovery systems and profited. One of these applications may be right for you, but even if it doesn't fit exactly, you'll find helpful approaches to solving many waste heat recovery problems.

In addition to case studies, the guidebook contains information on:

- sources and uses of waste heat
- determining waste heat requirements
- economics of waste heat recovery
- commercial options in waste heat recovery equipment
- instrumentation
- engineering data for waste heat recovery
- assistance for designing and installing waste heat systems

To order your copy of the *Waste Heat Management Guidebook*, send \$2.75 per copy (check or money order) to Superintendent of Documents, U.S. Government Printing Office, Washington, D.C. 20402. A discount of 25 percent is given on orders of 100 copies or more mailed to one address.

The *Waste Heat Management Guidebook* is part of the EPIC industrial energy management program aimed at helping industry and commerce adjust to the increased cost and shortage of energy.

**Announcement of New Publications
of the
National Bureau of Standards**

Superintendent of Documents,
Government Printing Office,
Washington, D. C. 20402

Dear Sir:

Please add my name to the announcement list of new publications as issued by the National Bureau of Standards.

Name.....

Company.....

Address.....

City..... State..... Zip Code.....

(Notification Key N519)

(cut here)

NBS TECHNICAL PUBLICATIONS

PERIODICALS

JOURNAL OF RESEARCH—The Journal of Research of the National Bureau of Standards reports NBS research and development in those disciplines of the physical and engineering sciences in which the Bureau is active. These include physics, chemistry, engineering, mathematics, and computer sciences. Papers cover a broad range of subjects, with major emphasis on measurement methodology, and the basic technology underlying standardization. Also included from time to time are survey articles on topics closely related to the Bureau's technical and scientific programs. As a special service to subscribers each issue contains complete citations to all recent NBS publications in NBS and non-NBS media. Issued six times a year. Annual subscription: domestic \$17.00; foreign \$21.25. Single copy, \$3.00 domestic; \$3.75 foreign.

Note: The Journal was formerly published in two sections: Section A "Physics and Chemistry" and Section B "Mathematical Sciences."

DIMENSIONS/NBS (formerly Technical News Bulletin)—This monthly magazine is published to inform scientists, engineers, businessmen, industry, teachers, students, and consumers of the latest advances in science and technology, with primary emphasis on the work at NBS. The magazine highlights and reviews such issues as energy research, fire protection, building technology, metric conversion, pollution abatement, health and safety, and consumer product performance. In addition, it reports the results of Bureau programs in measurement standards and techniques, properties of matter and materials, engineering standards and services, instrumentation, and automatic data processing.

Annual subscription: Domestic, \$12.50; Foreign \$15.65.

NONPERIODICALS

Monographs—Major contributions to the technical literature on various subjects related to the Bureau's scientific and technical activities.

Handbooks—Recommended codes of engineering and industrial practice (including safety codes) developed in cooperation with interested industries, professional organizations, and regulatory bodies.

Special Publications—Include proceedings of conferences sponsored by NBS, NBS annual reports, and other special publications appropriate to this grouping such as wall charts, pocket cards, and bibliographies.

Applied Mathematics Series—Mathematical tables, manuals, and studies of special interest to physicists, engineers, chemists, biologists, mathematicians, computer programmers, and others engaged in scientific and technical work.

National Standard Reference Data Series—Provides quantitative data on the physical and chemical properties of materials, compiled from the world's literature and critically evaluated. Developed under a world-wide program coordinated by NBS. Program under authority of National Standard Data Act (Public Law 90-396).

BIBLIOGRAPHIC SUBSCRIPTION SERVICES

The following current-awareness and literature-survey bibliographies are issued periodically by the Bureau:

Cryogenic Data Center Current Awareness Service. A literature survey issued biweekly. Annual subscription: Domestic, \$25.00; Foreign, \$30.00.

Liquified Natural Gas. A literature survey issued quarterly. Annual subscription: \$20.00.

NOTE: At present the principal publication outlet for these data is the Journal of Physical and Chemical Reference Data (JPCRD) published quarterly for NBS by the American Chemical Society (ACS) and the American Institute of Physics (AIP). Subscriptions, reprints, and supplements available from ACS, 1155 Sixteenth St. N.W., Wash., D.C. 20056.

Building Science Series—Disseminates technical information developed at the Bureau on building materials, components, systems, and whole structures. The series presents research results, test methods, and performance criteria related to the structural and environmental functions and the durability and safety characteristics of building elements and systems.

Technical Notes—Studies or reports which are complete in themselves but restrictive in their treatment of a subject. Analogous to monographs but not so comprehensive in scope or definitive in treatment of the subject area. Often serve as a vehicle for final reports of work performed at NBS under the sponsorship of other government agencies.

Voluntary Product Standards—Developed under procedures published by the Department of Commerce in Part 10, Title 15, of the Code of Federal Regulations. The purpose of the standards is to establish nationally recognized requirements for products, and to provide all concerned interests with a basis for common understanding of the characteristics of the products. NBS administers this program as a supplement to the activities of the private sector standardizing organizations.

Consumer Information Series—Practical information, based on NBS research and experience, covering areas of interest to the consumer. Easily understandable language and illustrations provide useful background knowledge for shopping in today's technological marketplace.

Order above NBS publications from: Superintendent of Documents, Government Printing Office, Washington, D.C. 20402.

Order following NBS publications—NBSIR's and FIPS from the National Technical Information Services, Springfield, Va. 22161.

Federal Information Processing Standards Publications (FIPS PUB)—Publications in this series collectively constitute the Federal Information Processing Standards Register. Register serves as the official source of information in the Federal Government regarding standards issued by NBS pursuant to the Federal Property and Administrative Services Act of 1949 as amended, Public Law 89-306 (79 Stat. 1127), and as implemented by Executive Order 11717 (38 FR 12315, dated May 11, 1973) and Part 6 of Title 15 CFR (Code of Federal Regulations).

NBS Interagency Reports (NBSIR)—A special series of interim or final reports on work performed by NBS for outside sponsors (both government and non-government). In general, initial distribution is handled by the sponsor; public distribution is by the National Technical Information Services (Springfield, Va. 22161) in paper copy or microfiche form.

Superconducting Devices and Materials. A literature survey issued quarterly. Annual subscription: \$30.00. Send subscription orders and remittances for the preceding bibliographic services to National Bureau of Standards, Cryogenic Data Center (275.02) Boulder, Colorado 80302.

U.S. DEPARTMENT OF COMMERCE
National Bureau of Standards
Washington, D.C. 20234

OFFICIAL BUSINESS

Penalty for Private Use, \$300

POSTAGE AND FEES PAID
U.S. DEPARTMENT OF COMMERCE
COM-215



SPECIAL FOURTH-CLASS RATE
BOOK
