

United States Department of Commerce  
Technology Administration  
National Institute of Standards and Technology

*NIST Special Publication 860*

---

# *Advanced Components for Electric and Hybrid Electric Vehicles*

**Workshop Proceedings  
October 27–28, 1993  
Gaithersburg, Maryland**

*K. L. Stricklett, Editor*

---

QC

100

.U57

#860

1994

**T**he National Institute of Standards and Technology was established in 1988 by Congress to "assist industry in the development of technology . . . needed to improve product quality, to modernize manufacturing processes, to ensure product reliability . . . and to facilitate rapid commercialization . . . of products based on new scientific discoveries."

NIST, originally founded as the National Bureau of Standards in 1901, works to strengthen U.S. industry's competitiveness; advance science and engineering; and improve public health, safety, and the environment. One of the agency's basic functions is to develop, maintain, and retain custody of the national standards of measurement, and provide the means and methods for comparing standards used in science, engineering, manufacturing, commerce, industry, and education with the standards adopted or recognized by the Federal Government.

As an agency of the U.S. Commerce Department's Technology Administration, NIST conducts basic and applied research in the physical sciences and engineering and performs related services. The Institute does generic and precompetitive work on new and advanced technologies. NIST's research facilities are located at Gaithersburg, MD 20899, and at Boulder, CO 80303. Major technical operating units and their principal activities are listed below. For more information contact the Public Inquiries Desk, 301-975-3058.

---

### **Technology Services**

- Manufacturing Technology Centers Program
- Standards Services
- Technology Commercialization
- Measurement Services
- Technology Evaluation and Assessment
- Information Services

### **Electronics and Electrical Engineering Laboratory**

- Microelectronics
- Law Enforcement Standards
- Electricity
- Semiconductor Electronics
- Electromagnetic Fields<sup>1</sup>
- Electromagnetic Technology<sup>1</sup>

### **Chemical Science and Technology Laboratory**

- Biotechnology
- Chemical Engineering<sup>1</sup>
- Chemical Kinetics and Thermodynamics
- Inorganic Analytical Research
- Organic Analytical Research
- Process Measurements
- Surface and Microanalysis Science
- Thermophysics<sup>2</sup>

### **Physics Laboratory**

- Electron and Optical Physics
- Atomic Physics
- Molecular Physics
- Radiometric Physics
- Quantum Metrology
- Ionizing Radiation
- Time and Frequency<sup>1</sup>
- Quantum Physics<sup>1</sup>

### **Manufacturing Engineering Laboratory**

- Precision Engineering
- Automated Production Technology
- Robot Systems
- Factory Automation
- Fabrication Technology

### **Materials Science and Engineering Laboratory**

- Intelligent Processing of Materials
- Ceramics
- Materials Reliability<sup>1</sup>
- Polymers
- Metallurgy
- Reactor Radiation

### **Building and Fire Research Laboratory**

- Structures
- Building Materials
- Building Environment
- Fire Science and Engineering
- Fire Measurement and Research

### **Computer Systems Laboratory**

- Information Systems Engineering
- Systems and Software Technology
- Computer Security
- Systems and Network Architecture
- Advanced Systems

### **Computing and Applied Mathematics Laboratory**

- Applied and Computational Mathematics<sup>2</sup>
- Statistical Engineering<sup>2</sup>
- Scientific Computing Environments<sup>2</sup>
- Computer Services<sup>2</sup>
- Computer Systems and Communications<sup>2</sup>
- Information Systems

---

<sup>1</sup>At Boulder, CO 80303.

<sup>2</sup>Some elements at Boulder, CO 80303.

*NIST Special Publication 860*

---

# *Advanced Components for Electric and Hybrid Electric Vehicles*

**Workshop Proceedings  
October 27–28, 1993  
Gaithersburg, Maryland**

---

K. L. Stricklett, Editor

Electricity Division  
Electronics and Electrical Engineering Laboratory  
National Institute of Standards and Technology  
Gaithersburg, MD 20899

March 1994



**U.S. Department of Commerce**  
Ronald H. Brown, Secretary

**Technology Administration**  
Mary L. Good, Under Secretary for Technology

**National Institute of Standards and Technology**  
Arati Prabhakar, Director

---

National Institute of Standards  
and Technology  
Special Publication 860  
Natl. Inst. Stand. Technol.  
Spec. Publ. 860  
212 pages (March 1994)  
CODEN: NSPUE2

U.S. Government Printing Office  
Washington: 1994

For sale by the Superintendent  
of Documents  
U.S. Government Printing Office  
Washington, DC 20402

# EXECUTIVE SUMMARY

This is a key period in the development of electric and hybrid electric vehicles. The landmark 1990 legislation in California requires that 2 percent of new automobiles be Zero Emission Vehicles (ZEV) in 1998, rising to 10 percent in the year 2005. This can only be met by Electric Vehicles (EV). The impact of this legislation could lead to as many as 150,000 EV per year in 2005. Thirteen other states and the District of Columbia have adopted or are in the process of adopting similar legislation, which could increase that total to 400,000 EV per year. Some estimates give the total EV industry to be \$8 billion by the end of the century. Another impact of the legislation is the potential for Hybrid Electric Vehicles (HEV) to satisfy the requirements for Ultra Low Emission Vehicles (ULEV).

The purpose of the workshop was to concentrate on the technologies to improve the design, performance, manufacturability, and economics of the critical components for the next generation of Electric Vehicles and Hybrid Electric Vehicles for the year 2000 and beyond. Nearly 200 representatives from the automobile manufacturers, aerospace companies, parts suppliers, universities, electric utilities, and state and federal government agencies and laboratories attended the workshop. The workshop was sponsored by the Advanced Technology Program at NIST, and organized through the Interagency Coordination Task Force on Electric and Hybrid Vehicle Technologies. The mission of the Task Force is to coordinate and integrate the programs and policies of Federal agencies in developing, testing, and promoting electric and hybrid vehicles and their associated technologies. The Task Force includes members from the Departments of Energy, Commerce, Defense, Transportation and Interior, the National Aeronautics and Space Administration, National Science Foundation, Environmental Protection Agency, Office of Science and Technology Programs, and Interagency Advanced Power Group.

The Workshop began with invited speakers to cover the general topics: impact of the California legislation, Federal agency programs, development of standards, infrastructure needs, ad-

vanced battery development, and the imperatives for commercial success of EVs and HEVs. The working sessions were five parallel meetings on Energy Conversion Systems, Energy Storage Systems, Electric Propulsion Systems, Controls and Instrumentation, and Ancillary Systems. Each session chairman had been requested to develop and present a "strawman" set of viewgraphs on the following areas to act as the basis for the discussions:

- Objectives
- Performance specifications
- Current technical, economic, and commercial barriers
- Potential technical solutions and opportunities for development
- Requirements and developments needed for improved manufacturing
- Schedule/timetable for EV and HEV component development
- Requirements of future standards/test procedures

The session reports in these proceedings include discussion and summaries by the session chairs, together with the expanded versions of these viewgraphs and other data and papers that were presented.

Presently, the major impetus for EVs and HEVs is from the environmental legislature for clean air and reduced auto emissions. There also will be additional impetus from the recent announcement by the Clinton Administration of an agreement to work collaboratively with the three U.S. automobile companies on the New Generation of Vehicles which will have three times the fuel efficiency of present internal combustion engine autos. In order for EVs and HEVs to successfully compete with the Internal Combustion Engine (ICE), these vehicles must match the performance as well as offer advantages of fuel economics and reduced or zero emissions, without any sacrifice on safety, warranty or convenience of use. There is clearly

a market for these vehicles, although this will require a significant financial investment by the auto companies and suppliers. It is possible that the market may initially develop in specialty areas, such as fleets, vans, autos for limited in-town use, niche autos, and vehicles for the military. However, it is important to note that hybrids are also being considered and tested for buses. For successful deployment of EVs, it is necessary to have an infrastructure, including charging stations and suitable standards. It is somewhat ironic to note that in 1912 there were 34,000 electric vehicles registered in the United States and an infrastructure of battery charging stations established between New York and Philadelphia for electric vehicles before the ICE took over the market because of their better performance and convenience.

The energy storage considerations are different for EV and HEV systems, being more critical for the EV system where all the energy must be stored. The main thrust for energy storage for auto is batteries, although fuel cells are planned for buses. Several of the advanced battery systems are under development by the United States Advanced Battery Consortium (USABC), including nickel metal hydride, sodium sulfur, lithium metal sulfide, and lithium polymer systems. It is still not clear if the USABC mid-term performance and cost goals can all be met. The long-term USABC goals, which are established to allow EVs to meet all the performance specifications of ICEs with an EV, are even further in the future. There is no clear winner yet, as became apparent when some seventeen alternative battery systems were listed during a workshop session discussion. Other high energy storage devices such as the "ultracapacitor" and mechanical storage (flywheel) systems are also promising and under development, and must be proven for performance, life, and cost.

There are still many alternatives for the energy conversion systems, depending upon the type of vehicle (e.g., auto, van, bus, or truck), whether it is an EV or HEV, and the required performance. The series and parallel designs of hybrid vehicles place different requirements on the energy conversion and energy storage systems. In the series hybrid system, the primary energy conversion system provides all of the power, with the energy being replenished by the secondary system. In the parallel hybrid system, the secondary energy stor-

age systems provide a power boost when needed to the primary energy system which fulfills the energy storage for range. There was general agreement at the workshop that not enough attention is being paid to the development of small engine technology to be used to replenish the energy for the hybrid systems; these small engines would be running at near optimum conditions for fuel efficiency and reduced emissions. It was also felt that there should be attention to hydrogen fueled or enriched fuel systems as a transitional technology from gasoline engines to other types of energy conversion systems. Proton Exchange Membrane (PEM) fuel cells, as well as Phosphoric Acid Fuel Cells (PAFC), are being developed for autos and buses, and Solid Oxide Fuel Cells (SOFC) are being promoted for the long term.

The electric propulsion system is probably the furthest along in the development, with some agreement that induction motors are probably the leading technology for power trains, and that brushless DC or inductive alternators are the leading technology for serial drive hybrids. Switched reluctance motors and synchronous reluctance drive configurations may become viable in the future. Maintenance and maintainability are key issues. For the control systems, the IGBT (Insulated Gate Bipolar Transistor) is the choice in most instances at higher voltages, and the power MOSFET (Metal Oxide Silicon Field Effect Transistor) is still effective at lower voltages and higher frequencies. There is a need to improve the performance of the IGBT for higher speed and lower losses. Cost is still a major issue; there is the need to reduce costs an order of magnitude below traditional power electronics industry standards.

The instrumentation and controls follow the developments of the other systems required for EVs and HEVs. Control algorithms are an important area, as are standards for interfaces internal within the vehicle, from the vehicle to the infrastructure, and from the vehicle to the driver. Control systems for hybrid electric vehicles are significantly more complex than for pure EV. Monitoring the energy storage system to determine the effective remaining range is still a major challenge; this will clearly be dependent on the type of energy storage system and the characteristic driving technique of the driver, all of which may have to be eventually modeled. Self test of the electronics, inter-

faces, sensors, and monitoring system will be required. All of the components in the ancillary systems must be optimized in parallel in order to get the greatest benefit in efficiency. Key components considered in the ancillary systems are:

- Battery chargers and associated infrastructure (conductive and inductive systems are under consideration and test).
- The braking system, where a major challenge is to have regenerative and conventional friction braking working together in a seamless, smooth operation.
- Heating, ventilation, and air conditioning must be very efficient; high efficiency heat pumps are used, with the possibility of Peltier devices (based on solid state devices) for long-term future use, after further development to improve the performance.

- Power steering assemblies under development include a hybrid electric system as the boost mechanism, although there is a need for this to be a very high reliability system.

Important themes that ran through all of the sessions were the need for development of the manufacturing infrastructure and improved manufacturing techniques to significantly reduce the cost of the components; the importance of standards for the components, the interfaces between them, and at interfaces for data exchange; and the need to reduce the risk for investment in technology development and the formation of new manufacturing facilities and the infrastructure. The innovation and expertise are there for solving the technical challenges. It is the economic challenges that must be met for the successful introduction of the major new industry of electric and hybrid vehicles.

Alan H. Cookson  
National Institute of Standards and Technology  
January 1994

**ORGANIZING COMMITTEE MEMBERS**

R. W. Bartholomew	S. Miles
A. H. Cookson	E. Simmon
G. J. FitzPatrick	G. N. Stenbakken
S. Hsiung	K. L. Stricklett
T. Leedy	R. Sutula
J. Merritt	

**TECHNICAL CHAIRMAN**

A. H. Cookson

**SESSION CHAIRMEN**

R. W. Bartholomew	T. Lester
L. Bell	H. J. King
C. C. Christianson	A. Sobey

**SESSION SECRETARIES**

D. Spiewak	J. W. Weber
G. L. Henriksen	T. Winter
A. Lee	

**SESSION ORGANIZERS**

G. J. FitzPatrick	E. Simmon
F. Hart	G. N. Stenbakken
A. R. Hefner, Jr.	

**PUBLICATION COMMITTEE**

G. J. FitzPatrick	K. L. Stricklett
E. Simmon	

**LOCAL ARRANGEMENTS**

K. Kilmer	J. Pitt
L. Phillips	J. Von Feldt



# TABLE OF CONTENTS

Executive Summary	iii
-------------------	-----

## INVITED PRESENTATIONS<sup>1</sup>

California's Zero Emission Vehicle Requirements and Implications for Hybrid Electric Vehicles . . . . .	<i>T. Cackette</i>	3
An Overview of the DOE Electric and Hybrid Propulsion Systems Program . . . . .	<i>K. F. Barber</i>	19
Infrastructure Needs for EV and HEV . . . . .	<i>S. Barsony, D. R. Spiewak, and S. Hsiung</i>	26
Electric and Hybrid Electric Automobiles Imperatives for Commercial Success . . . . .	<i>C. Marks</i>	33
Advanced Battery Commercialization . . . . .	<i>J. Williams</i>	40
Electric Vehicle Standards—The Current Status . . . . .	<i>R. I. Sims</i>	53

## WORKING SESSION REPORTS

Session Report: Energy Conversion Systems . . . . .	<i>R. W. Bartholomew and A. Sobey</i>	65
Opening Remarks for the Parallel Session on Energy Conversion Systems . . . . .	<i>R. W. Bartholomew</i>	71
The Hydrogen Hybrid Option . . . . .	<i>J. R. Smith</i>	76
On-Board Plasmatron Generation of Hydrogen-Rich Gas for Engine Pollution Reduction . . . . .	<i>A. Rabinovich, D. R. Cohn, and L. Bromberg</i>	83
Thermo-Electric-Compound Engine for Hybrid Vehicles . . . . .	<i>M. A. Paul</i>	89
Phosphoric-Acid Fuel-Cell Bus Development . . . . .	<i>R. J. Kevala</i>	97
Zero-Emission Technology Projects . . . . .	<i>M. A. Bogdanoff and J. H. Leonard</i>	102
Non-Technical Barriers to Product Commercialization . . . . .	<i>A. J. Sobey</i>	106
Session Report: Energy Storage Systems . . . . .	<i>C. Christianson and G. L. Henriksen</i>	116
The DOE Ultracapacitor Program . . . . .	<i>E. Dowgiallo</i>	131
Westinghouse Zinc-Air Battery Development for Electric Vehicle Applications . . . . .	<i>H. E. Saunders</i>	144
Quasi Bipolar Lead-Acid Battery (Woven Lead Composite Grid) . . . . .	<i>J. Lushetsky</i>	146

---

<b>Common Vessel Battery Technology</b> . . . . .	<i>A. Nilsson</i>	147
<b>Flywheel Technology</b> . . . . .	<i>R. Post</i>	154
<b>Promising Future Energy Storage Systems: Nano-Material Based Systems, Zn-Air, and Electromechanical Batteries</b> . . . . .	<i>R. Koopman and J. Richardson</i>	156
<b>Session Report: Electric Propulsion Systems</b> . . . . .	<i>L. E. Lesster</i>	164
<b>An Induction-Motor Power Train for EVs—The Right Power at the Right Price</b> . . . . .	<i>L. E. Lesster, F. A. Lindberg, R. M. Young, and W. B. Hall</i>	170
<b>Session Report: Instrumentation and Controls</b> . . . . .	<i>H. J. King and J. W. Weber</i>	174
<b>Session Report: Ancillary Systems</b> . . . . .	<i>L. E. Bell</i>	182

## THE NIST ADVANCED TECHNOLOGY PROGRAM

<b>An Introduction to the NIST Advanced Technology Program</b> . . . . .	<i>T. Leedy</i>	199
--	-----------------	-----

# LIST OF FIGURES

<b>California's Zero Emission Vehicle Requirements...</b>	<b>3</b>
1. Elements of the California Air Resource Board program . . . . .	8
2. California's air quality problem . . . . .	8
3. Reactivity adjustment . . . . .	9
4. Technology developments . . . . .	9
5. Emission durability on-board diagnostics . . . . .	10
6. Benefits of zero emission vehicles . . . . .	10
7. Fuel evaporative emissions . . . . .	10
8. Electricity generation . . . . .	11
9. Zero emission vehicle progress . . . . .	11
10. Purpose-built electric vehicle technology . . . . .	12
11. Battery development . . . . .	12
12. US Advanced Battery Consortium . . . . .	12
13. Air Resource Board contracts . . . . .	13
14. The sealed bipolar lead-acid battery . . . . .	13
15. Future zero emission vehicle technologies . . . . .	13
16. Hybrid-electric vehicles . . . . .	14
17. Air quality benefits of hybrid electric vehicles . . . . .	14
18. Low emission vehicle regulation and hybrids . . . . .	15
19. Hybrid electric vehicle certification . . . . .	15
20. Could a hybrid electric vehicle be a zero emission vehicle? . . . . .	15
21. Advanced hybrid electric vehicle technology . . . . .	16
22. Electric vehicle air quality benefits . . . . .	16
23. Costs . . . . .	16
24. Infrastructure . . . . .	17
25. Conclusions . . . . .	17
26. Assumptions for power plant emissions . . . . .	17
27. Hybrid electric versus zero emission vehicle and internal combustion engine . . . . .	18
 <b>An Overview of the DOE Electric and Hybrid Propulsion Systems Program</b>	 <b>19</b>
1. Major elements of the DOE electric and hybrid propulsion systems program . . . . .	20
2. Phosphoric acid fuel cell for small urban buses . . . . .	21
3. Proton-exchange-membrane fuel cell for light-duty vehicles . . . . .	21
4. Advanced multi-fuel reformer technology development . . . . .	23
5. Single shaft AC propulsion system development . . . . .	23
6. Hybrid vehicle research and development . . . . .	24
7. Coordination of DOE Electric and Hybrid Propulsion program activities . . . . .	25
 <b>Advanced Battery Commercialization</b>	 <b>40</b>
1. General Motors Impact III . . . . .	40
2. General Motors Impact III in snow . . . . .	41
3. General Motors Impact III wind tunnel testing . . . . .	42
4. General Motors Impact III HVAC testing . . . . .	43
5. General Motors Impact III crash test . . . . .	44

6.	General Motors Impact III on Belgian Blocks . . . . .	45
7.	Available batteries have low energy . . . . .	46
8.	High-energy batteries are expensive . . . . .	46
9.	Optimizing the battery system . . . . .	47
10.	USABC statement of purpose . . . . .	47
11.	USABC structure . . . . .	48
12.	USABC and federal government agreements . . . . .	48
13.	USABC funding . . . . .	49
14.	Electric vehicle range . . . . .	49
15.	New USABC development contract . . . . .	50
16.	Battery technology time line . . . . .	52
17.	USABC accomplishments . . . . .	52
<b>Electric Vehicle Standards—The Current Status</b>		<b>53</b>
1.	SAE standards groups . . . . .	53
2.	The U.S. standards interface . . . . .	54
3.	International EV standards process flow . . . . .	59
4.	Development route for international EV standards . . . . .	60
5.	The stages of development of international standards . . . . .	61
<b>The Hydrogen Hybrid Option</b>		<b>76</b>
1.	Vehicle efficiency estimates for conventional, battery powered electric, and hybrid . .	78
2.	Vehicle emissions estimates for conventional, battery powered electric, and hybrid . .	80
<b>On-Board Plasmatron Generation of Hydrogen-Rich Gas...</b>		<b>83</b>
1.	Water plasmatron. . . . .	85
2.	Energy and mass flow diagram . . . . .	85
<b>Thermo-Electric-Compound Engine for Hybrid Vehicles</b>		<b>89</b>
1.	Detail of piston-ring design . . . . .	90
2.	State-of-the-art engine efficiency . . . . .	91
3.	Fundamental test results on B.S.F.C., NO <sub>x</sub> , and P <sub>max</sub> . . . . .	92
4.	Comparison of thermodynamic cycles. . . . .	92
5.	Float 1: Monocylinder test rig assembly . . . . .	95
6.	Float 2: Monocylinder test rig assembly . . . . .	96
<b>Phosphoric-Acid Fuel-Cell Bus Development</b>		<b>97</b>
1.	Artist's rendering of the test-bed bus. . . . .	98
2.	Test-bed bus hardware configuration. . . . .	100
<b>Session Report: Energy Storage Systems</b>		<b>116</b>
1.	Energy storage systems discussion areas . . . . .	118
2.	Energy storage systems session objectives . . . . .	118
3.	Performance specifications . . . . .	119
4.	Desired EV and HEV energy storage system performance . . . . .	119
5.	Commercial issues . . . . .	121
6.	Technical solutions and opportunities for development . . . . .	122

7.	Energy storage systems requirements for standards . . . . .	123
8.	Energy storage systems requirements for standards . . . . .	124
9.	Energy storage requirements for dual-mode and power-assist HEVs . . . . .	125
<b>The DOE Ultracapacitor Program</b>		<b>131</b>
1.	Peak power density requirement for a pulse-power unit in a compact car . . . . .	132
2.	U.S. Department of Energy ultracapacitor program . . . . .	132
3.	Specifications for Panasonic 3 V, 1500 F capacitors . . . . .	135
4.	Carbon/metal fiber electrode structure . . . . .	136
5.	Milestone chart for ultracapacitor development . . . . .	137
6.	Specifications of the Maxwell/Auburn 1 V, 75 F capacitor . . . . .	137
7.	Specifications of the Maxwell/Auburn 3 V, 27 F capacitor . . . . .	138
8.	Conclusions . . . . .	138
9.	Objectives . . . . .	139
10.	Deliverables . . . . .	139
11.	Milestones . . . . .	140
12.	What's possible with nanostructure multilayers? . . . . .	140
13.	Why are sub-micron multilayers of interest? . . . . .	140
14.	Strengths . . . . .	141
15.	Why do we care about capacitors? . . . . .	141
16.	Weaknesses . . . . .	141
17.	Projected specific-energy and specific-power for NMCs with various dielectrics . . . . .	142
18.	Cost analysis for multilayer capacitors . . . . .	143
<b>Westinghouse Zinc-Air Battery Development for Electric Vehicle Applications</b>		<b>144</b>
1.	Objective. . . . .	144
2.	Advantages of the zinc-air battery. . . . .	145
3.	Summary . . . . .	145
<b>Common Vessel Battery Technology</b>		<b>147</b>
1.	The large battery challenge . . . . .	147
2.	Current battery design options. . . . .	148
3.	Common vessel monoblock battery—A new solution. . . . .	149
4.	Key to the new design. . . . .	149
5.	Common vessel monoblock advantages. . . . .	150
6.	Schematic of a monoblock concept battery. . . . .	150
7.	Operation of a common vessel monoblock battery. . . . .	150
8.	Reactions at regulator . . . . .	151
9.	Summary . . . . .	153
<b>Flywheel Technology</b>		<b>154</b>
1.	Advantages of the electromechanical battery. . . . .	154
2.	Advantages of the electromechanical battery. . . . .	154
3.	Electromechanical battery unit cost projections . . . . .	155
4.	Advantages of the electromechanical battery. . . . .	155

<b>Promising Future Energy Storage Systems...</b>	<b>156</b>
1. Schematic of the enhancement in charge storage capability . . . . .	157
2. Capacitance density for various carbon aerogel catalyst ratios . . . . .	157
3. Observed versus model discharge performance . . . . .	158
4. Cross section of a multilayer capacitor . . . . .	159
5. Volumetric capacitance and voltage breakdown curves multilayer capacitors . . . . .	159
6. Effects of carbon and lithium cobalt dioxide utilization on energy density. . . . .	160
7. Layout of an electromechanical battery . . . . .	162
<b>Session Report: Electric Propulsion Systems</b>	<b>164</b>
1. Time frame for development of a commercially viable power train. . . . .	167
2. Performance specifications . . . . .	168
3. Key technologies and their state-of-the-art performance . . . . .	168
4. Technology of EV Power Trains—Systems and Components . . . . .	168
5. Key components—Motor controllers . . . . .	169
6. Controller components . . . . .	169
<b>An Induction-Motor Power Train for EVs...</b>	<b>170</b>
1. Dynamometer test of 100-hp electric power train. . . . .	170
2. Stock pick-up truck performance 100-hp electric drive versus ICE options. . . . .	170
3. Highway acceleration and regenerative braking of van. . . . .	171
4. Prototype versus production system efficiency at 3000 RPM. . . . .	171
5. Motor plus controller efficiency. . . . .	171
6. Motor controller operating envelope. . . . .	172
7. Electric vehicle power train path to target cost. . . . .	173
<b>Session Report: Instrumentation and Controls</b>	<b>174</b>
1. Energy storage . . . . .	176
2. Power train performance . . . . .	177
3. Vehicle subsystem controllers . . . . .	178
4. Environmental interface . . . . .	179

# LIST OF TABLES

<b>California's Zero Emission Vehicle Requirements...</b>	<b>3</b>
1. Low-emission vehicle categories . . . . .	8
2. Certification status of low-emission vehicles . . . . .	9
3. Zero emission versus ultra-low emission vehicles . . . . .	11
4. Cost implication of battery technology . . . . .	14
5. Battery technologies . . . . .	18
 <b>Advanced Battery Commercialization</b>	 <b>40</b>
1. USABC development goals . . . . .	50
2. Battery development contracts . . . . .	50
3. Battery development contracts (cont.) . . . . .	51
4. Cooperative Research and Development Agreements . . . . .	51
5. Performance projections relative to mid-term criteria . . . . .	51
 <b>Electric Vehicle Standards—The Current Status</b>	 <b>53</b>
1. Summary of ERIP performance indicators for the years 1975–1990. . . . .	73
2. Summary of power requirements of various accessories used in vehicles . . . . .	74
3. Sample values for the coefficient of rolling resistance . . . . .	74
4. Aerodynamic drag coefficient of selected vehicles . . . . .	74
 <b>The Hydrogen Hybrid Option</b>	 <b>76</b>
1. Vehicle comparison technology assumptions. . . . .	77
 <b>Thermo-Electric-Compound Engine for Hybrid Vehicles</b>	 <b>89</b>
1. Comparison of the monocylinder test rig with state-of-the-art engines . . . . .	93
 <b>Phosphoric-Acid Fuel-Cell Bus Development</b>	 <b>97</b>
1. Test-bed bus performance and gradability requirements. . . . .	99
2. Georgetown University Transportation Society test cycle. . . . .	101
 <b>Session Report: Energy Storage Systems</b>	 <b>116</b>
1. USABC primary criteria for electric vehicles . . . . .	120
2. USABC secondary criteria for electric vehicles . . . . .	120
3. Data on existing electric vehicle batteries . . . . .	121
4. Battery development and manufacturing opportunities . . . . .	121
5. Technical, economic, and commercial barriers . . . . .	122
6. Schedule/timetable for component development . . . . .	122
7. Energy storage technologies identified . . . . .	126
8. Energy storage technologies identified (cont.) . . . . .	127
9. Energy storage technologies identified (cont.) . . . . .	128
10. System energy versus power . . . . .	130
11. Projected availability of energy storage systems . . . . .	130
 <b>The DOE Ultracapacitor Program</b>	 <b>131</b>
1. Near-term and advanced goals for ultracapacitor programs . . . . .	131

2.	Status of ultracapacitor technologies . . . . .	133
3.	Status of ultracapacitor technologies with projections . . . . .	134
<b>Quasi Bipolar Lead-Acid Battery</b>		<b>146</b>
1.	Characteristics of the quasi bipolar lead-acid battery . . . . .	146
<b>Common Vessel Battery Technology</b>		<b>147</b>
1.	Performance characteristics of common vessel monoblock batteries . . . . .	152
2.	Design features in the common vessel monoblock battery . . . . .	152
<b>Promising Future Energy Storage Systems...</b>		<b>156</b>
1.	Estimates of range extension and weight reduction for an urban bus . . . . .	161
<b>Session Report: Instrumentation and Controls</b>		<b>174</b>
1.	Summary . . . . .	180
2.	Summary 2 . . . . .	181
<b>Session Report: Ancillary Systems</b>		<b>182</b>
1.	Key technologies and their state-of-the-art performance . . . . .	187
1a.	Key technologies and their state-of-the-art performance (cont.) . . . . .	188
2.	Key performance specifications for the next generation of component . . . . .	189
2a.	Key performance specifications for the next generation of component (cont.) . . . . .	190
3.	Current technical, economic, and commercial barriers of these components . . . . .	191
3a.	Current technical, economic, and commercial barriers of these components (cont.) . . . . .	192
4.	Possible solutions to technical barriers . . . . .	193
5.	Improved manufacturability and manufacturing needs . . . . .	194
6.	Schedule/timetable for component development . . . . .	195
7.	Components not reviewed . . . . .	196



## INVITED PRESENTATIONS



## CALIFORNIA'S ZERO EMISSION VEHICLE REQUIREMENTS AND IMPLICATIONS FOR HYBRID ELECTRIC VEHICLES

T. Cackette  
Chief Deputy Executive Officer  
California Air Resources Board  
Sacramento, CA 95814

### ABSTRACT

The Air Resources Board has adopted stringent tail pipe emission standards for new 1994 and subsequent light-and medium-duty vehicles sold in California. The first vehicles meeting these requirements are now for sale. Beginning in 1998, the larger vehicle manufacturers will be required to certify that 2 percent of their light-duty vehicles have zero tail pipe emissions. Initially, these will be battery-powered electric vehicles (EVs). Progress in developing commercially viable EVs is rapid. In 1994, prototype EVs will enter the marketplace with the objective of better quantifying consumer reaction. Improvements to the lead acid battery are being made, and a huge research effort to develop highly advanced batteries is underway. Remaining issues are the extent of consumer demand for EVs, how much advancement in battery performance will occur by 1998, and whether ultra-low emission hybrid EVs, whose emissions are no more than the urban emissions from the electricity generating system, can be developed.

### INTRODUCTION

In September, 1990, the Air Resources Board (CARB) adopted more stringent tail pipe emission standards for new cars, and light-duty trucks, beginning with the 1994 model year. These regulations require each vehicle manufacturer to meet, on a fleet-average basis, a non-methane organic gas (NMOG) tail pipe emission standard, which declines annually, and by 2003 is 75 percent lower than in 1994. A vehicle manufacturer may certify a specific model to any one of four different low emission vehicle (LEV) tail pipe standards, or to conventional standards. The average of the NMOG standards, for all vehicles produced in that year, determines if a manufacturer is in compliance.

The four low emission standards are referred to as TLEV, LEV, ULEV TLEV and ZEV TLEV, where "T" refers to transitional, "U" to ultra, and "Z" to zero. The NMOG standards for these categories are 50, 70, 84 and 100 percent lower, respectively, than the 0.16 gram per kilometer hydrocarbon tail pipe emission standard for conventional cars and light trucks. The oxides of nitrogen

(NO<sub>x</sub>) emission standard for the LEV and ULEV categories is 50 percent more stringent.

The first model meeting TLEV standards was certified in 1992, and as of October, 1993, over ten 1994 models were certified as TLEVs, and one as a LEV. Manufacturers who certify early, or produce more LEVs than are required to meet the fleet average NMOG standard, receive emission credits which may be used to help meet future emission requirements, or may be traded or sold.

The photochemical reactivity, i.e., the smog-forming potential, of the exhaust of vehicles certifying on fuels other than conventional gasoline is also determined, and those vehicles with less reactive exhaust are allowed to emit more mass of exhaust NMOG. This allows fuel type to be considered as an additional, and possibly more cost effective, approach to meeting tail pipe standards, and removes a regulatory barrier to the use of alternative fuels. In essence, this reactivity adjustment transforms the mass of NMOG emissions to a grams ozone per kilometer basis. Reducing ambient ozone is the primary objective of the LEV regulations.

CARB has also adopted new evaporative emis-

sion standards, and requires new vehicles to be equipped with a comprehensive on-board diagnostic system that checks the performance of key emission control systems on an on-going basis. If the performance of an emission control system degrades such that emissions exceed the certification standard by 50 percent, a warning light is illuminated, and information to help the repair technician identify and fix the problem is stored in the on-board computer. By 1996, all LEVs will be equipped with on-board diagnostics, and by 1998 all will meet the more stringent evaporative emission standard.

### **THE ZERO EMISSION VEHICLE (ZEV) MANDATE**

A mandate to produce and offer for sale zero emission vehicles is included in the LEV regulations. Each major manufacturer (the top seven based on current sales) is required to produce ZEVs at a rate of 2 percent of total light duty vehicle production, beginning with the 1998 model year. This requirement increases to 5 percent of sales in 2001, and 10 percent of sales in 2003, when all but the smallest vehicle manufacturers must produce ZEVs. By 2003, over a quarter million ZEVs will be operating in California. If all the states which have expressed interest in adopting California's program do so, cumulative ZEV production could reach one million by 2003.

The mandate was adopted based on three primary considerations. First, even with LEVs dominating the fleet by 2010, the sheer number of vehicles in the Los Angeles basin, and the distance they travel (projected to be 10 million, and 230 billion kilometers per year, respectively) will continue to make motor vehicles a significant contributor to smog. On-road motor vehicles alone, in 2010, are projected to contribute nearly 100 percent of the emissions that can be tolerated without exceeding the federal ozone ambient air quality standard in the Los Angeles basin. For this reason the CARB staff identified ZEVs as a means of further reducing the adverse health impacts of air pollution in Los Angeles during the first decade of the 21st century.

The second consideration is ZEVs emit much fewer emissions than even the cleanest internal combustion engines, including the ULEV. Internal

combustion engines have historically experienced a deterioration in emissions with age, and on average emit hydrocarbon emissions at a rate three times the emission standard to which they were certified. This is true even in the presence of periodic inspection programs whose goal is to encourage maintenance and discourage tampering with emissions control devices. Improved inspection programs, and on-board diagnostics, are expected to lower in-use emissions of future vehicles. However, maintaining emissions at or near the certification emission standards throughout the vehicle's life, which now extends well beyond 160,000 kilometers, remains a formidable challenge. ZEVs have no tail pipe emissions to deteriorate—zero will always be zero. They also emit no toxic emissions, and have substantially lower CO<sub>2</sub> emissions than conventional vehicles.

ZEVs also have no evaporative emissions. Even vehicles subject to the new, more stringent evaporative emission standards will emit an equivalent 0.09 gram per kilometer hydrocarbons due to fuel evaporation from the vehicle and various points of fuel transfer. This is nearly four times the allowable tail pipe standard for a ULEV. Only vehicles using low volatile fuels (e.g. neat methanol), or dedicated vehicles with sealed fuel systems (e.g. compressed natural gas), and ZEVs, avoid this major source of emissions.

California is also fortunate to have one of the world's cleanest electricity generating systems. Nearly all in-state, combustion generated power uses natural gas as fuel, and during the next decade most of these power plants will add emission control systems which will reduce NO<sub>x</sub> emissions by another 70 percent (68 grams/MW·h). Emissions from power plants are minimal. In the Los Angeles basin, only 20 percent of power demand is met from in-basin, combustion power plants. Other sources of power include hydroelectric, nuclear, geothermal, wind, and combustion-generated power produced in areas downwind of the basin. The in-basin power plant NO<sub>x</sub> emissions resulting from charging battery powered ZEVs, expressed in grams per kilometer of ZEV operation, are only 0.0025. By comparison, the NO<sub>x</sub> emissions of a ULEV are 50 times higher. Even if all power plant emissions are considered, including out-of-state purchased power that is coal generated, the NO<sub>x</sub> emission rate for a ZEV is 0.06

gram per kilometer, and is not subject to deterioration over time. Although illustrative, this worst case scenario is not relevant to public policy for urban smog reduction since the downwind power plant emissions cause far less public health and welfare damage than do internal combustion engines emitting within the Los Angeles basin.

The third consideration in adopting the ZEV mandate related to technology. The battery has always been, and remains so today, the Achilles heel of electric vehicles. However, advancements in other aspects of electric vehicles, including aerodynamics, electric motor and control efficiency, lightweight materials and regenerative braking, make it possible to design a viable electric vehicle that can accommodate the limitations of current battery technology. Evidence the General Motors Impact electric vehicle. It remains our belief that a commercially viable electric vehicle can be built and sold that does not require highly advanced batteries, the existence which at this time remains dependent on more research and development.

## BATTERIES

The adoption of the ZEV mandate has stimulated a worldwide effort to develop ZEV technologies, including advanced batteries. U.S. battery manufacturers, car companies, utilities and the federal government have begun a multi-hundred million dollar effort to develop advanced batteries for electric vehicles. This consortium, called the U.S. Advanced Battery Consortium (USABC), established a mid-term goal for an advanced battery that would be available for use in 1998 model year ZEVs. At this time it is doubtful if a battery meeting the mid-term goals will be available. A longer term goal for more advanced batteries, such as those based on lithium, was also established. The consortium has not supported advancements in lead acid batteries. Funds to support advanced lead acid batteries have come from battery manufacturers, utilities, technology companies, and CARB, however the amount of this funding pales in comparison to the resources being expended on advanced batteries other than lead acid.

The CARB staff has concluded that the lead acid battery is the primary battery technology which will be used in 1998 ZEVs. This is consistent with the assumptions made at the time

the regulations were adopted in 1990. We reached this conclusion because the state of development of other battery technologies has not advanced sufficiently to be ready for production by 1998, or because of current high costs and need for frequent replacement of technologies such as the sodium sulfur battery. This conclusion is shared by many of the seven car companies that must produce ZEVs in 1998.

The question remaining is will these initial ZEVs use conventional lead acid batteries (three years life, 35 W-h/kg), or will advanced lead acid batteries based on bipolar technology (50 W-h/kg, five plus years life) be ready for production. This is a significant question because the higher energy density promised by sealed bipolar lead acid batteries (SBLA) increases vehicle range, and the longer life reduces operating costs, two factors which would increase the market demand for ZEVs.

Two examples illustrate this point. The range of the GM Impact using an equal mass of SBLA batteries instead of conventional batteries, would be extended from a quoted 113 kilometers (city) to 161 kilometers on the CARB standard driving cycle. The operating cost, including the amortized cost of the battery, is highly dependent on battery cost and replacement interval. Ford Motor Company officials often quote the operating cost of its sodium sulfur battery powered ZEV as \$0.92 per equivalent liter of gasoline (\$3.50 per gallon). Yet the operating cost of a GM Impact, with SBLA batteries having a seven year life (~1,000 cycles) is less than the operating cost of a similar gasoline powered vehicle. Of all the factors, replacement interval and cost dominate operating costs, and should be an important guiding factor in the selection of battery technology.

## TECHNOLOGY REVIEWS

In adopting the LEV and ZEV requirements, CARB was aware of the need to periodically review the development of technologies, and make adjustments as needed. The first biennial review, which focused primarily on LEVs, concluded that technology was developing ahead of schedule. The next review is scheduled for summer, 1994, and will focus on ZEV technology, including the role of hybrid electric vehicles.

Cost and cost effectiveness of regulatory requirements are important considerations which also need periodic review. The cost of a battery ZEV is uncertain because vehicle designs remain proprietary, and battery technology, and the battery replacement interval, have not been finalized. CARB has calculated the environmental value of a ZEV, compared to a comparable vehicle sold in the late 1990s, to be roughly \$5,000. This value is the avoided cost of seeking equivalent emissions reductions of smog-forming pollutants, CO<sub>2</sub>, and toxic materials from other sources.

### HYBRID ELECTRIC VEHICLES

At the time the LEV regulations were adopted (1990), CARB was aware of several prototype hybrid electric vehicles (HEVs). These vehicles typically featured a conventional internal combustion engine auxiliary power unit (APU), which in series with the electric motor, served to extend range. Because these engines were typically fueled with volatile liquids such as gasoline, they had evaporative emissions. Being conventional engines, they were subject to in-use deterioration of emissions with age or lack of maintenance. Some designs were such that battery deterioration could be overcome by increased use of the APU. In the view of CARB staff, these hybrids were clearly not ZEVs. However, to the extent that these hybrids operated on batteries charged from the electric grid, they could benefit air quality more than a well controlled internal combustion engine such as a ULEV.

To provide an appropriate incentive to manufacturers who chose to produce hybrids, the LEV regulations established hybrid emission levels based on the range the vehicle could operate on the batteries alone. A HEV that could operate approximately 100 kilometers on batteries alone would be credited with emissions half way between a ULEV and ZEV. Thus a vehicle manufacturer would obtain the same credit towards the NMOG average standard for producing one HEV or two ULEVs. HEVs with shorter range on the battery received less credit.

Since then our understanding of possible HEV technologies has evolved, as has our quantification of related power plant emissions. It has been suggested that APUs could be developed which emit

no more than the power plant that provides electricity to charge the vehicle's battery pack. If this were the case, then a HEV should be considered a ZEV. Reviewing the rationale behind the establishment of the ZEV mandate, as discussed above, we can visualize a HEV that is as clean as a ZEV.

Such a vehicle would use an APU that is highly durable, most likely not an Otto cycle engine that is dependent on exhaust treatment and extensive feedback to maintain precise air/fuel control, since this involves sensors and catalysts whose performance can deteriorate with time. Possible technologies include the gas turbine, which obtains NOx control through lean operation, and fuel cells. The engine would not use a volatile liquid fuel such as gasoline or methanol mixtures (e.g. M85) that result in evaporative emissions from the vehicle as well as the fueling infrastructure. Fuels such as natural gas and hydrogen, which are contained in a sealed fuel system, would assure no evaporative emissions. Hydrogen would need to be produced on board using a reformer with only trace emissions, or off-board using a low polluting production technology. If the VOC emissions for the APU and associated fuel infrastructure were less than the associated electricity production emissions within the Los Angeles air basin (i.e. less than 0.0025 gram per kilometer NOx, and less than 0.0003 gram per kilometer NMOG), the HEV would have no more impact on air quality than a ZEV.

Other technologies which may qualify as ZEVs include fuel cells, and flywheels. Fuel cell development is advancing rapidly, and prototypes for larger vehicles have been developed. Flywheel technology is also receiving attention and funding. California government and the private sector are investing funds in both of these technologies. However, technological advancements and cost reduction challenges remain, suggesting that commercialization of these technologies for light duty vehicles will not occur until after the turn of the century.

CARB staff is evaluating the policy implications of allowing ultra-low emitting HEVs to qualify as ZEVs. We will be evaluating the types of HEV technologies under development, and their implications for life-cycle emissions. We intend to propose appropriate emission standards and test procedures for HEV APUs, and definitions governing

their emission durability.

### SUMMARY AND CONCLUSIONS

Substantial progress in developing commercially viable ZEVs by 1998 is being made. Efficient vehicle and component designs are emerging which when packaged with current battery technology should result in a vehicle which can serve the needs of many Californians, the majority of which drive less than 80 kilometers per day. Hundreds of pre-production prototypes designed to test the consumer's reaction to ZEVs will be on the road in 1994.

Improvements in battery technology are also being made, although advanced batteries which meet the USABC mid-term goals are unlikely to be available for use in the first 1998 model ZEVs.

The greatest short-term opportunity for advancing the capabilities of ZEVs is the SBLA battery, whose improved energy density and extended lifetime could substantially increase the market for ZEVs. Unfortunately, adequate resources are not being directed to commercialization of this battery. A major effort to realize, within the next two years, the potential of this technology is needed.

Because ZEVs will use many new technologies and new parts, their initial cost, for the first few years, will be higher than conventional vehicles. To offset this cost, incentives are being developed. The National Energy Act provides a tax credit of 10 percent of the cost of the vehicle, up to \$4,000. The electric utilities in California have proposed a \$1,500 rebate, and free installation of charging units in the purchaser's home (\$800 value). A state tax credit is also under consideration by the California Legislature. It appears likely that upwards of \$5,000 in credits will be available in California to the initial purchasers of ZEVs.

Substantial progress is underway to assure an infrastructure is available to support ZEVs. California's electric generation system can support millions of ZEVs through use of off-peak charging. Off-peak charging will include opportunity charging during much of the day for those ZEV owners in need of extending their vehicle's range. The city of Los Angeles intends to be the first ZEV-ready-and-friendly city in the country, by 1998. Battery recycling infrastructure is in place to handle the lead acid batteries expected to be used in most

ZEVs sold in this decade.

Although most of the impetus for battery development and ZEV production stems from the CARB ZEV 1998 mandate, momentum has been added by several public-private partnerships that are focusing on applying the skills of the state's high-technology work force on ZEVs. For example, CALSTART, a consortium of California technology companies, is developing ZEV components, charging equipment, and electric shuttle buses. Project California is putting in place the mechanism to attract new ZEV-related businesses and jobs to California. These investments in California's ZEV future are one more sign of the confidence we have towards realizing electric transportation in our state.

## APPENDIX A: PRESENTATION VIEW-GRAPHS

### Elements of ARB's LEV Program

---

- Begins with 1994 model year
- Increasingly stringent fleet average standard for NMOG
- Three low-emission vehicle categories
- Zero-emission vehicle requirements

Figure 1.

### California's Air Quality Problem

---

- Six of the seven worst areas for ozone in the country are located in California: Los Angeles, San Bernardino, San Diego, Bakersfield, Anaheim-Santa Ana, and Fresno
- Los Angeles exceeds ambient air quality standards for:
  - ozone
  - carbon monoxide
  - particulate matter
  - nitrogen dioxide

Figure 2.

Table 1. Low-emission vehicle categories (Emissions listed are in grams per mile.)

Category	NMOG*	CO	NOx
Conventional	0.25	3.4	0.4
TLEV	0.125	3.4	0.4
LEV	0.075	3.4	0.2
ULEV	0.04	1.7	0.2
ZEV	0	0	0

\*adjusted for exhaust reactivity



---

### Reactivity Adjustment

- Adjust NMOG emission from clean fuel vehicles for ozone potential
- Previous standards were mass-based
- Allows all vehicle/fuel systems to be compared without bias

**Figure 3.**

---

### Technology Developments

- Development has exceeded original projections:
  - Progress in EHC technology
  - Use of palladium-only close-coupled catalyst
  - Improved fuel systems
  - Large catalysts, more precious metal loading
- Biennial update 1994: ZEVs and HEVs

**Figure 4.**

**Table 2.** Certification status of low-emission vehicles

	TLEV Indolene	TLEV Phase 2 Gas	TLEV M85	MDV LEV CNG
1993	2	3	3	1
1994	3	6	3	2

---

### Emission Durability On-board Diagnostics

---

- On-board diagnostic checks emission control system
- Warning light and information for repair technician
- On-board diagnostics completely phased in by 1996

Figure 5.

---

### Benefits of ZEVs

---

- No deterioration of emission control systems
- Low associated power plant emissions
- No toxic emissions
- Lower CO<sub>2</sub> emissions
- No evaporative or gasoline marketing emissions

Figure 6.

---

### Fuel Evaporative Emissions

---

- ZEVs have no evaporative emissions
- Most stringent standard for emitting vehicles:  
0.09 g/km HC

Figure 7.

---

### Electricity Generation

- No significant impact on 20-year planning forecasts
- "Time of use" rates will encourage off-peak charging
- Increased use of "clean" renewable resources (solar, geothermal, wind)

**Figure 8.**

**Table 3.** ZEV versus ULEV emissions (g/km)

Pollutant	LA <sup>1</sup>	Statewide <sup>2</sup>	ULEV
NOx	0.0025	0.06	0.12
ROG	0.0003	0.001	0.025

<sup>1</sup>LA power plants only (20% of total power needed)

<sup>2</sup>Includes out-of-state emissions

---

### ZEV Progress

- Commercially viable by 1998
- Range will be adequate
- Prototypes on the road today

**Figure 9.**

---

### Purpose-built EV Technology

---

#### Improvements in:

- Motors
- Controllers
- Regenerative braking
- Aerodynamics
- Low rolling resistance tires

**Figure 10.**

---

### Battery Development

---

- Weak link
- Short-term improvements — 1998
- Advanced batteries

**Figure 11.**

### USABC

---

- Consortium of US battery manufacturers, car companies, utilities, and government
- Current USABC contracts focusing on these technologies:
  - Nickel-metal hydride
  - Lithium-polymer
  - Lithium-aluminum iron sulfide

**Figure 12.**

---

**ARB Contracts**

---

- SBLA (SDG&E — Arias Research)
- SBLA (Pinnacle Research)
- Ultracapacitors (Pinnacle Research)
  - complement of SBLA technology

**Figure 13.**

---

**Sealed Bipolar Lead-Acid**

---

- Highest power of any current battery even at low state-of-charge
- Moderate energy density (100-mile range)
- Longer life
- Zero maintenance
- Low cost (similar to standard lead-acid)

**Figure 14.**

---

**Future ZEV Technologies**

---

- Fuel cell prototypes have been developed
- Flywheels under development
- Technological and cost reduction challenges
- Commercialization after 2000

**Figure 15.**

**Table 4.** Cost implication of battery technology<sup>1</sup>

Battery type	Energy Density (W·h/kg)	Cost (\$/kW·h)	Life (years)	Estimated (\$/mile)
Lead-Acid <sup>2</sup>	35	100	2-3	0.05
SBLA <sup>3</sup>	50	100	5	0.03
USABC Mid-term (Ni-MH, Na-S)	80	150	3	0.06
USABC Ling-term (Li-P, Li-(metal)S <sub>2</sub> )	200	100	5	0.03

<sup>1</sup> Assumes 1000 lb battery pack, 0.24 kW·h/mile, and 200 cycles/year

<sup>2</sup> Delco-Remy/GM Impact battery pack

<sup>3</sup> Numbers for SBLA are projections

### Hybrid-Electric Vehicles

- Increased range compared to pure EVs
- HEVs have emission control systems that are subjected to deterioration or failure
- HEVs have fuel transfer emissions (for volatile fuels)
- HEV tail pipe and evaporative emissions can be much greater than EV power plant emissions

**Figure 16.**

### Air Quality Benefits of HEVs

- Cleaner than ULEVs
- Potential for greater use in ZEV mode
- Ultra-clean APU could equal power plant emissions

**Figure 17.**

---

### LEV Regulations and HEVs

---

- LEV regulations handle HEVs in "neutral" way
- More EV range relates to lower emissions

Figure 18.

---

### HEV Certification

---

- Based on range of operation on batteries
- If APU certified to ULEV emission standard and:
  - less than 100 km =  $0.5 \times$  ULEV NMOG standard; or
  - 70 to 100km =  $0.75 \times$  ULEV NMOG standard

Figure 19.

---

### Could a HEV be a ZEV?

---

- ZEVs have power plant emission from battery recharging
- ZEV power plant emissions are small in California
- Theoretically possible to have HEV emissions less than or equal to ZEV plant emissions

Figure 20.

---

### Advanced HEV Technology

---

- Highly durable APU with little possibility of deterioration
- No evaporative emissions (natural gas- of hydrogen-fueled)
- Emissions less than power plant emissions in Los Angeles Basin:
  - 0.0025 g/km NO<sub>x</sub>; and
  - 0.0003 g/km NMOG

Figure 21.

---

### EV Air Quality Benefits

---

- \$5,000 per vehicle
- Value based on:
  - avoided emission from average vehicle (1996–2000)
  - cost to control stationary sources
- Includes HC, NO<sub>x</sub>, CO, CO<sub>2</sub>, and toxic emissions

Figure 22.

---

### Costs

---

- Initial purchase price higher
- Incentives
  - \$5,000 benefit justified
  - NEA tax credit up to \$4,000
  - Utility incentives: \$1,500 rebate and free charging unit proposed
  - State tax credit proposed

Figure 23.



---

### Infrastructure

---

- Off-peak charging
- Opportunity charging
- California will be ZEV friendly by 1998
- Battery recycling

**Figure 24.**

---

### Conclusions

---

- Motor vehicles account for more than half of the ozone precursor and CO emission in California
- ZEVs represent one of the most effective means of reducing motor vehicle emissions in California
- If HEV emissions are equal to or below EV emissions, a HEV could potentially be a ZEV

**Figure 25.**

---

### Assumptions Used to Calculate Emissions from Power Plant

---

- 20 percent of the power SCAB will be generated
- EVs use 0.15 kW·h per km
- Utility emission factors
  - ROG = 0.02 lbs/MW·h
  - NO<sub>x</sub> = 0.1 lbs/MW·h

**Figure 26.**

---

### HEV versus ZEV and ICE

---

- ZEV + ICE scenario cleaner
- HEV + ICE only cleaner when HEV uses 100% battery
- Preliminary analysis: deterioration of HEV not included
- Deterioration will increase HEV emissions

Figure 27.

Table 5. Battery technologies

	Na-S	Na-NiCl <sub>2</sub>	Ni-MH	SBLA
Maturity	o	+	-	-
Energy density	+	+	+	o
Power density	o	o	o	+
Lifetime	-	o	o	o
Cost	-	-	-	+

+ good, o tolerable, - poor

# AN OVERVIEW OF THE DOE ELECTRIC AND HYBRID PROPULSION SYSTEMS PROGRAM

K. F. Barber

Director, Electric and Hybrid Propulsion Division  
Office of Propulsion Systems, U.S. Department of Energy  
Washington DC, 20585

## ABSTRACT

The Department of Energy continues to focus its efforts on the technologies that are critical in making electric and hybrid vehicles competitive with conventional vehicles in cost, performance, and reliability. The successful penetration of electric and hybrid vehicles in the U.S. vehicle population is necessary if these vehicles are to contribute significantly to solving a number of national problems, including dependence on foreign oil, poor air quality, and the negative balance of trade. DOE continues to work with industry in addressing the critical technical barriers and is coordinating its efforts with other federal agencies engaged in similar research and development activities through the Interagency Coordination Task Force on Electric and Hybrid Vehicle Technologies. This paper provides an overview of the DOE program.

## INTRODUCTION

The successful penetration of electric (EV) and hybrid electric vehicles (HEVs) into the U.S. vehicle fleet would allow the transportation sector to partially meet its demand for energy with electricity. Dependence on petroleum fuels would be reduced, since only about four percent of electricity in the United States is generated from petroleum. Electric and hybrid electric vehicles will not only reduce reliance on petroleum and result in more efficient energy use in the transportation sector, but will also help to reduce severe urban environmental pollution problems. Emissions from on-board fuel combustion are partly (in the case of hybrid vehicles) or fully (in the case of electric vehicles) removed from the street level and, in most cases, from the urban area. In fact, electric vehicles will be essentially non-polluting if they use electricity generated from non-fossil fuels. Even in areas where electric power generation is almost exclusively from fossil fuels, the substitution of electric vehicles for gasoline-fueled vehicles would result in net reductions of carbon monoxide, hydrocarbons, and nitrogen oxide emissions. In economic terms, large national gains could result from creating and expanding domestic and international

markets for domestically-produced electric and hybrid vehicles. However, they still need to be developed and made competitive with conventional, gasoline-powered vehicles in terms of cost, performance, and safety.

## THE DOE ELECTRIC AND HYBRID PROPULSION SYSTEMS PROGRAM

Recognizing the large potential for energy, environmental, and economic benefits to the Nation, DOE is devoting considerable resources to an Electric and Hybrid Propulsion Systems Program focused on developing critical component and vehicle system technologies that will enable industry to:

- Commercialize a 100-mile range electric vehicle in the near-term (1993-1996);
- Commercialize a 250-mile range electric vehicle and demonstrate an unlimited range, ultra-low emission hybrid vehicle in the mid-term (1996-2000); and
- Commercialize cost-competitive, zero-emission vehicles with range and performance

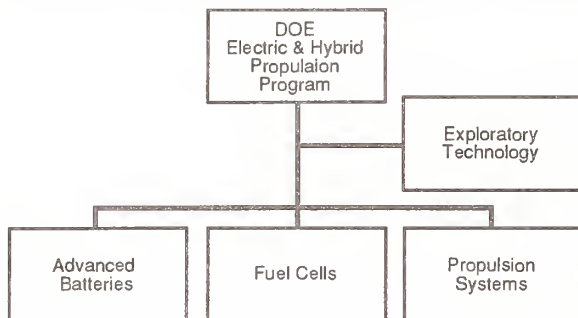

Figure 1. Major elements of the DOE electric and hybrid propulsion systems program.

equivalent to conventional gasoline-powered vehicles in the long-term (2000–2005).

Specific program objectives are based on achieving steady improvements in key technologies, such as batteries, fuel cells, and propulsion systems, thus enabling industry to provide commercially acceptable vehicles that will capture a larger market share as the technological progress is achieved.

The Electric and Hybrid Propulsion Systems Program continues to work cooperatively with industry on the development of critical technologies that will lead to the commercial production of electric and hybrid vehicle systems in the mid- to late-1990s. The major program elements are shown in Fig. 1. Research and development activities currently focus on advanced battery systems, fuel cells, propulsion systems, and other critical technologies that are needed to make electric and hybrid vehicles commercially competitive with conventional gasoline-fueled vehicles. Field demonstration of vehicles and infrastructure development efforts are also receiving increased attention.

The *Energy Policy Act (EPAct) of 1992* (Public Law 102-486) significantly expands support for the DOE Program and mandates several activities to promote the commercialization of electric and hybrid vehicles. Section 2025 specifically authorizes the expansion of DOE's R&D activities on batteries, fuel cells, and other related EV and HEV technologies. In compliance with these requirements, DOE has developed a comprehensive *Electric and Hybrid Vehicle R&D Program Plan*. The EPAct also requires DOE to establish a Commercial Market Demonstration Program for electric

and hybrid vehicles and to initiate a cost-shared Electric Motor Vehicle Infrastructure and Support Systems Development Program. A new *Field Operations Program Plan* has been developed to address these EPAct-mandated activities in conjunction with an expanded Site Operators Program. This plan will be implemented in FY 1994 based on available resources.

### Advanced Batteries R&D

DOE's cooperative agreement with the U.S. Advanced Battery Consortium (USABC) has provided a major boost to advanced battery R&D activities. This 50-50 cost-shared effort is focused on the development of the most promising battery technologies for EVs and HEVs and is driving toward a set of ambitious mid- and long-term battery goals. Several contracts have been signed with teams of battery companies to develop nickel/metal hydride, lithium polymer, and lithium/iron disulfide battery systems. Similarly, cooperative research and development agreements (CRADAs) have been signed with DOE laboratories to assist in the development and testing of advanced battery technologies. In tandem with the R&D on advanced battery systems, DOE also supports exploratory technology research at the national laboratories to investigate promising electrochemical cells that will meet the long-term goals of the USABC.

### Fuel Cells R&D

DOE is working closely with industry to develop commercially viable, fuel cell propulsion systems for light-duty and heavy-duty vehicles. More specifically, the current focus is on: developing and demonstrating the phosphoric acid fuel cell in an urban transit bus as a near-term application (by 1995); developing the methanol-fueled, proton-exchange-membrane (PEM) fuel cell as a mid-term option for passenger vehicles; and providing fuel flexibility by developing advanced reformers (to convert hydrocarbon fuels to hydrogen for use by fuel cells) and by developing improved hydrogen storage systems for on-board vehicle use with fuel cells.

Of the fuel cell technologies, the phosphoric acid fuel cell is the only one suitably developed for

Program Schedule	FY	1988	1989	1990	1991	1992	1993	1994	1995
Phase I: Feasibility Evaluation		[Bar spanning 1988-1990]							
• Preliminary Design		[Bar spanning 1988-1989]							
• Power Source Test			[Bar spanning 1989-1990]						
Phase II: Fabrication of Buses					[Bar spanning 1991-1994]				
Phase III: Bus Test and Evaluation								[Bar spanning 1994-1995]	
Phase IV: Prototype Bus Fleets									[Bar spanning 1995]

- Methanol-fueled
- 50% higher fuel economy, 90% lower emissions, 10-20 db noise reduction
- Co-sponsored by DOE, DOT/FTA, & SCAQMD

Figure 2. Phosphoric acid fuel cell for small urban buses.

Program Schedule	FY	1990	1991	1992	1993	1994	1995	1996	1997
Phase I: Feasibility Evaluation		[Bar spanning 1990-1993]							
• Preliminary Vehicle Design			[Bar spanning 1991-1992]						
• 10-kW Power Source Test			[Bar spanning 1991-1993]						
Phase II: Proof-of-Feasibility					[Bar spanning 1993-1994]				
• Propulsion System Integration					[Bar spanning 1993-1994]				
• 25-kW Laboratory Test						[Bar spanning 1994-1995]			
Phase III: System Scale-up							[Bar spanning 1995-1996]		
• 50-kW Propulsion System							[Bar spanning 1995-1996]		
Phase IV: Proof-of-Concept								[Bar spanning 1996-1997]	
• Install and Test in Vehicle								[Bar spanning 1996-1997]	

- In comparison to gasoline engines:
  - 70-80% higher fuel economy
  - competitive range and performance
  - near-zero emissions
- Phase I prime contractor: Allison Division of GM

Figure 3. Proton-exchange-membrane fuel cell for light-duty vehicles.

transportation applications at this time. An urban transit bus was selected as the initial test vehicle because it can readily accommodate the packaging of the first generation fuel cell powered propulsion system. The development of a phosphoric acid fuel cell propulsion system for a small urban bus follows the schedule shown in Fig. 2. This effort is co-sponsored by the Department of Transportation/Federal Transit Administration and California's South Coast Air Quality Management District. In Phase I, two industrial teams demonstrated the feasibility of the concept by building and testing a laboratory brass-board power system half the size needed for the bus. Phase II of this project, a 25 percent cost-shared contract awarded by DOE to H-Power Corporation, includes fabrication and delivery of three 29-ft, 25-passenger ur-

ban buses, and the design for a full-size 40-ft urban bus. The first test bed bus will be delivered in October, with two more to follow in FY 1994. All of these vehicles will then be subjected to rigorous test and evaluation.

The proton-exchange-membrane (PEM) fuel cell, when fully developed, will offer significant advantages over the phosphoric acid fuel cell including reduced size and weight, faster start-up, and potentially lower cost. A fully integrated PEM fuel cell propulsion system will have the potential to meet the size and weight requirements for use in automobiles, vans, and light trucks. The schedule for the development of the PEM fuel cell for light-duty vehicles is shown in Fig. 3. As the prime contractor for Phase I, General Motors (Allison Gas Turbine Division) is responsible for overall

system integration. Support is provided by Los Alamos National Laboratory for reformer development and fuel cell testing, Dow Chemical Company for membrane fabrication and testing, Ballard power systems for fuel stack fabrication, GM Research Laboratories for electrode and catalyst studies, and GM Advanced Engineering staff for vehicle system engineering. The Phase I effort will culminate in FY 1993 with the integration and testing of a complete 10-kW PEM fuel cell system that will lay the groundwork for future engineering scale-up and integration of a PEM fuel cell propulsion system into a vehicle.

Development of advanced reformer and hydrogen storage technologies will not only provide fuel flexibility for fuel-cell-powered vehicles but will also reduce system size and cost, reduce start up time, and increase transient response capability, characteristics that will improve the competitiveness of fuel cell vehicles. DOE awarded a cost-shared R&D contract to A. D. Little, Inc. to develop advanced fuel processing systems to reform methanol, ethanol, natural gas, and other hydrocarbons into hydrogen for use in transportation fuel cell systems and to develop better systems for on-board hydrogen storage. The schedule shown in Fig. 4 for the development of the multi-fuel reformer technology is divided into two phases. Phase I (Feasibility Studies) is directed at examining system trade-offs (i.e., reformer size, weight, efficiency, life, cost transient response, and others) in the design of hydrogen storage systems and reformers for hydrocarbon fuels. The outcome of Phase I will be the specifications for the reformer and hydrogen storage system to be developed in Phase II, where a 10-kW reformer and a 1-kg hydrogen storage proof-of-concept systems will be built and tested. The project is expected to be completed by November 1994.

A ten-year research and development plan has been completed in FY 1993 and is delineated in the document entitled *A National Program Plan for Fuel Cells in Transportation*. The plan was developed from a consensus formed at two meetings of an ad hoc technical panel consisting of more than fifty representatives from the transportation industry, universities, national laboratories, government agencies, regulatory bodies, and alternative fuels proponents. In 1994, DOE will initiate several new projects: to develop power manage-

ment devices for fuel cell vehicles; to assess the feasibility of fuel cell locomotives; and to develop a light-duty passenger/utility vehicle powered by a PEM fuel cell system with on-board hydrogen storage.

### Propulsion Systems R&D

Focus of this effort has been in the development of a modular electric vehicle propulsion system and a new initiative in FY 1993 for the development of a hybrid vehicle propulsion systems.

Through a series of projects conducted jointly with Ford Motor Company and General Electric since 1984 (see Fig. 5), DOE has advanced the state of alternating current (AC) power train technology to the point at which it can provide the basis for competitive electric vehicles as soon as an adequate battery technology becomes available. A prototype advanced modular AC power train suitable for mass production has been developed and project completion is expected in FY 1993 with the delivery of the prototype system in a test bed van to DOE for testing. Field testing of production modular AC power trains will be performed and funded by Ford Motor Co. in FY 1994 and beyond.

The Hybrid Vehicle Program was recently initiated as a five-year, cost-shared cooperative program that will involve industry teams to develop and demonstrate hybrid/electric propulsion systems for light duty vehicles. These systems will satisfy EPA Tier II emissions standards, improve fuel economy by as much as 100 percent, and offer performance characteristics that are competitive with those of conventional vehicles in all other aspects. The systems will incorporate high-power batteries and heat engine technologies developed by DOE and industry programs. Industry teams have been identified by DOE through the competitive procurement process and as of August 1993, a contract with General Motors Corporation was signed September 30, 1993, and negotiations on a second contract are underway. The schedule for the hybrid vehicle research and development program is shown in Fig. 6.

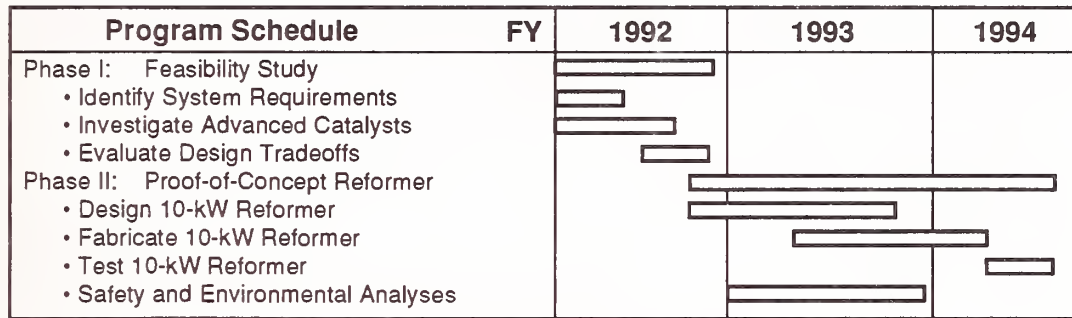

- Improved start-up time
- Increased response characteristics
- Fuel flexibility
- Reduced size and cost

Figure 4. Advanced multi-fuel reformer technology development.

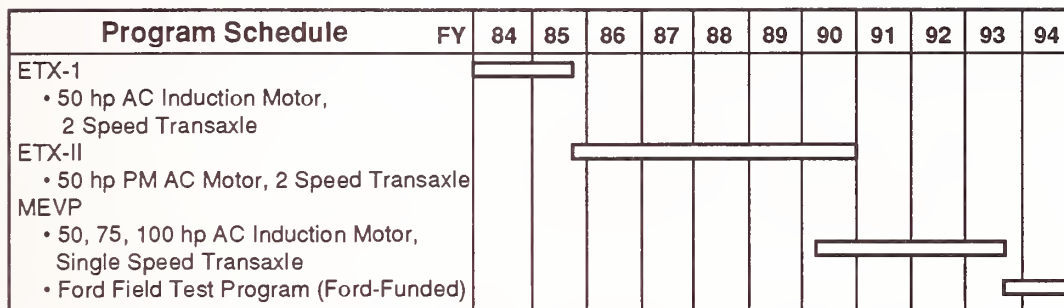

- Single shaft integrated motor/transaxle
- Advanced modular AC powertrain suitable for mass production
- Applicable to broad range of vehicle types and sizes
- Cost-shared with Ford Motor Company / General Electric

Figure 5. Single shaft AC propulsion system development.

**PROGRAM IMPLEMENTATION**

The Electric and Hybrid Vehicle Program emphasizes the involvement of industry in the successful implementation of its research and development. Industry participation and input is solicited in the planning process to identify and review critical technical barriers and technology requirements. This involvement assures that the DOE program funds are directed to problems and issues industry deems a priority. The technical program focuses on the critical technologies identified through industry and government collaboration; the technical agenda is executed jointly between industry, national laboratories, and universities;

and research activities are conducted through a cooperative endeavor involving industry, private research and development laboratories, universities, and federally funded laboratories. This cooperation affords considerable opportunity for interdisciplinary review of technology needs, definition of problems requiring solutions, and for ready transfer of research results to the technology users.

Figure 8 shows the level of coordination between the DOE Program and the private and public R&D for electric and hybrid vehicle program activities. In 1993, the Interagency Coordination Task Force on Electric and Hybrid Vehicle Technologies was organized to coordinate and integrate programs and policies of Federal agencies involved

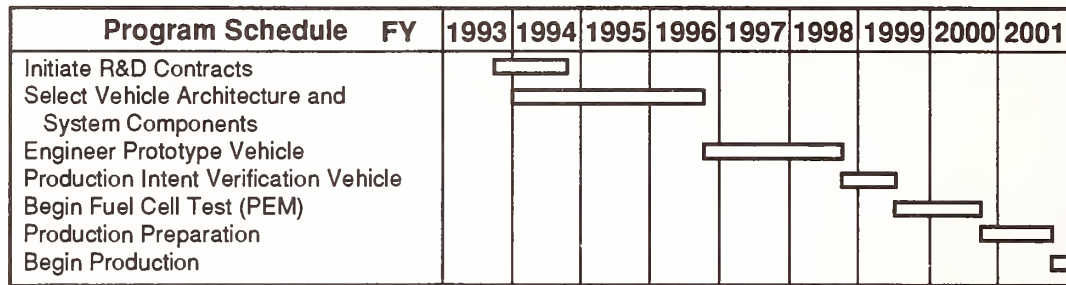

- Develop and demonstrate a hybrid propulsion system for light-duty vehicles before the year 2000
  - high efficiency
  - ultra-low emissions
  - fuel-flexible

**Figure 6.** Hybrid vehicle research and development.

in developing, testing, and promoting electric and hybrid vehicles and associated technologies. Over ten Federal agencies are currently represented on the Task Force, with DOE playing a coordinating role. The Task Force meets at least once every quarter to review and discuss the agencies' programs, progress, and opportunities for coordination.

## CONCLUSION

DOE has ensured that its activities are focused and continue to focus on the technical issues that are critical in making electric and hybrid vehicles commercially viable by actively soliciting private sector input during the formulation of its research and development agenda. DOE also ensures that duplication of efforts is minimized by coordinating with other Federal agencies conducting similar activities in electric and hybrid vehicles technologies development. The experience of the DOE Electric and Hybrid Propulsion Systems Program in dealing with the U.S. Advanced Battery Consortium in developing a critical technology such as the advanced battery systems should also serve DOE well, especially in the recently announced partnership between government and industry to develop a new generation of vehicles.



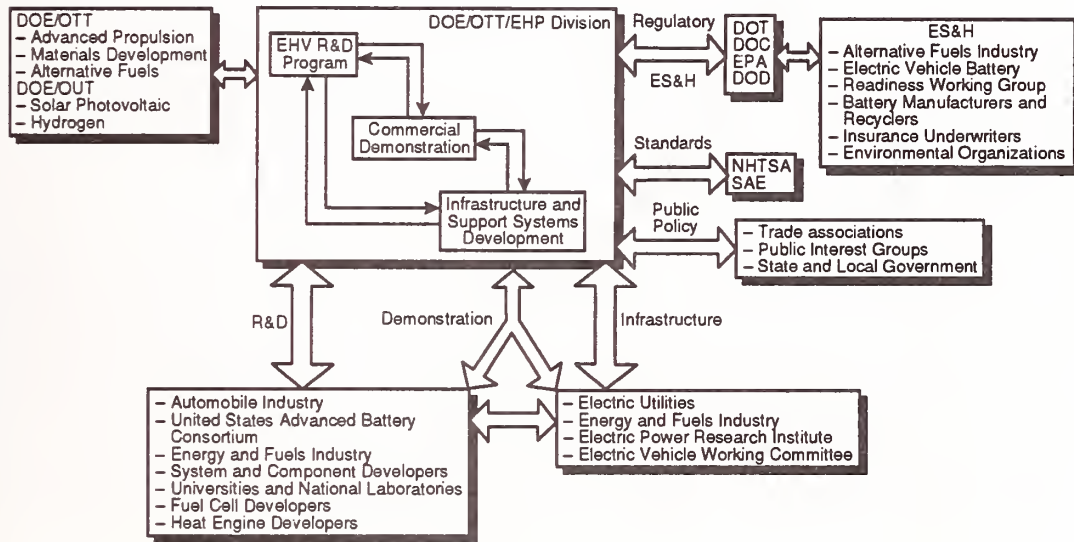

Figure 7. Federal and non-federal coordination of DOE Electric and Hybrid Propulsion program activities.

## INFRASTRUCTURE NEEDS FOR EV AND HEV

S. Barsony, D. R. Spiewak, and S. Hsiung  
Office of Engineering, Federal Transit Administration  
Washington, D.C. 20590

### ABSTRACT

For Electric Vehicles (EVs) and Hybrid Electric Vehicles (HEVs) to be successfully incorporated into America's transportation system, an infrastructure equal in availability and reliability to the existing infrastructure for internal combustion engine vehicles must be put in place. The ultimate challenge is to develop the necessary support infrastructure to enable EVs and HEVs to match the internal combustion engine vehicles' ability to travel and be serviced virtually everywhere. For EVs and HEVs to be universally accepted, they must ultimately not only be able to provide reliable transportation for daily urban commutes, but also for intercity travel as well. Supporting infrastructures within metropolitan areas as well as between metropolitan areas must be developed before this can happen.

Prompted by deteriorating air quality and failure to meet the requirements of the 1990 Clean Air Act Amendments, the California state legislature enacted landmark legislation mandating introduction of zero emission vehicles (ZEVs) in that state. Following California's lead, many other states intend to implement the same tough vehicle emissions standards, which require that in 1998 two percent of car and light duty truck sales of automakers with annual in-state sales of over 35,000 vehicles be ZEVs. The percentage increases to ten percent in the year 2003. Estimates on the market size for ZEVs vary; one projection is that as many as 588,000 could be on the road by the end of 2003 [1]. EVs and HEVs are two current technologies that are suitable for meeting the ZEV requirements. In order for EVs and HEVs to be accepted by the consumer though, an infrastructure to support them must be developed and put in place concurrently with the introduction of these vehicles. The required infrastructure includes not only the charging and refueling facilities, but all appurtenant support systems, including driver training, safety and emergency programs, battery and component recycling programs, maintenance facilities and training programs and public awareness education.

### INTRODUCTION

Electric carriages and trucks were in regular use in the early part of this century because they were reliable, easily maintained and easily operated. By 1912, 34,000 electric cars were registered in the United States, and charging stations were established between New York and Philadelphia [2]. However, the availability of less expensive gasoline and gasoline-powered vehicles with better performance pushed the electric vehicles into a dormant state. They are now making a come-back for several compelling reasons.

The transportation sector is the largest user of petroleum in the United States and currently accounts for approximately 28 percent of the total energy expended in the United States [3]. Last year, The U.S. used 38 percent more oil than was

produced domestically, which was about 64 percent of the total domestic consumption of oil [4]. This heavy dependence on imported oil is detrimental to the national energy security and the balance of trade. The total number of privately and publicly owned motor vehicles registered in the United States grew at an exponential rate from 1900 to 1990; at the end of 1990 there were nearly 190 million registered trucks, buses and automobiles in the U.S. [5]. At the projected annual growth rates of 1.7 percent for automobiles and light duty motor vehicles and 1.9 percent for heavy duty trucks and buses by the end of 2010 there could be nearly 267 million registered vehicles. The annual increases in vehicle miles of travel is outstripping the gains achieved through improved automotive emissions control technology. Thus, although the vehicles that are in use emit fewer

pollutants, we are using them so much more that more pollutants are actually being emitted.

In giving effect to the California Clean Air Act of September, 1990 for mitigating air quality problems, the California Air Resources Board requires that beginning in 1998, two percent of all light-duty vehicles offered for sale in that state will have to be ZEVs. The percentage of ZEVs rises to five percent in the year 2001 and to ten percent in the year 2003. Thirteen other states (viz. CT, DE, IL, ME, MD, MA, NH, NJ, NY, PA, RI, TX, VT) and the District of Columbia have adopted or are in the process of adopting similar legislation. These fourteen states and the District of Columbia accounted for 6.4 million new car sales out of 14 million total sold in 1990 in the United States, amounting to 45.7 percent of the market [6]. As of now, only electric vehicles meet the ZEV emissions requirements. Thus, if these states implement similar legislation and sales match the regulatory requirements, up to 1.7 million electric vehicles could well be on the road by the end of 2003.

Impressive progress has been made in the past several years in the development and improvement of EVs and HEVs, to the point where several vehicles are ready for commercial introduction. However, there is a somewhat benign neglect and apathy by the technical systems engineering community when it comes to supporting infrastructure. Without the appropriate supporting infrastructure, there cannot be a large scale deployment of EVs. The magnitude of the problem becomes evident when it is realized that there is one gas station for every 4000 internal combustion engine vehicles and other similar facilities for repairs, parts, customer information, and so on. Significant effort now needs to be directed toward defining, designing and implementing all of the necessary infrastructure to support EVs and HEVs.

Successful definition, deployment, and growth of an infrastructure to support EVs and HEVs presents a difficult "chicken and egg" problem. Without an existing infrastructure to support them, consumers are hesitant to purchase these new vehicles; without sales of significant numbers of vehicles, investment in infrastructure by automakers, dealers and utility companies is difficult. Clearly, there must be a coordinated approach taken to bring about the necessary steps to assure that the new vehicles will be introduced

into the marketplace at the same time that required additions are made to satisfy infrastructure requirements.

### WHAT IS INFRASTRUCTURE?

Simply stated, infrastructure is the collection of all facilities and services required for safe and economical operation, maintenance and disposal of vehicles and their subsystems. It is not unreasonable for the customer to expect the same, if not better, convenience from the infrastructure as is currently available for automobiles, trucks, or buses. A comprehensive support infrastructure will not be developed overnight. The investment required is enormous!!! The question is how we plan to implement the development of that infrastructure so that efficiencies can be maximized.

An Infrastructure Working Committee was set up under the auspices of the Electric Power Research Institute (EPRI) by the electric utility industry with participation from the auto industry and others. Specific areas have been identified by the Infrastructure Working Committee in their Transportation Infrastructure Research Plan [7]. These provide a comprehensive basis for addressing the infrastructure development and deployment issues and are listed below. Figure 3 of the reference provides further breakdown.

- Connecting and connecting stations
- Health and Safety
- Load Management, Distribution, and Power Quality
- Data Interfaces
- Utility Information and customer education

### CURRENT INFRASTRUCTURE SITUATION

#### Electricity availability

Many studies have been done to determine the capability of the existing generation, transmission and distribution system to support EVs. Utility companies, acting through EPRI have been working hard for the past decade to prepare for and promote EVs. One recent study [8] revealed

that existing generation capacity could support 86 million EVs if charged during off-peak times. It is anticipated that initially most private EVs may be charged in this manner. Transit vehicles are typically operated during the day and parked overnight, so it can be anticipated that off-peak recharging would likely be used for most of these vehicles, too. However, for intercity travel, charging during peak times must also be available.

#### **Existing recharging stations**

As the interest in EVs and HEVs has grown, so too has the number of recharging stations in operation. Two of the four consortia recently awarded grants by the Federal Transit Administration as part of the Advanced Transportation Systems and Electric Vehicle Research and Development Program [9] are installing a significant number of recharging stations as part of their projects; CALSTART, in cooperation with the Los Angeles Department of Water and Power, Sacramento Municipal Utility District and local utilities has already installed ninety charging stations and plans to install fifty more, and the Chesapeake Consortium has installed seven recharging stations and is now working on the installation of rapid recharging stations. A third grantee, the Advanced Lead-Acid Battery Consortium is studying and developing rapid recharging techniques for lead-acid batteries. The ultimate goal is to develop charging systems that are "user friendly." The complexities of different charging systems and battery types should be totally transparent to the customer.

#### **Existing FTA EV and HEV programs**

The fourth grantee of the Federal Transit Administration's EV Program, the New York Consortium, is designing, building and testing two 40-foot Hybrid Electric Transit Buses. Both will be low-floor designs utilizing diesel engines initially, and will be able to be converted to alternate fuel heat engines at a later date. The Federal Transit Administration is also involved in major research and development programs with the fuel cell transit bus program at Georgetown University, advanced technology transit bus programs in Los Angeles and Houston and the Electric Transit Vehicle Institute in Chattanooga, Tennessee.

## **INFRASTRUCTURE REQUIREMENTS FOR EVs AND HEVs**

### **Batteries**

Advanced battery designs are being vigorously pursued by the U.S. Advanced Battery Consortium. There are many new kinds of batteries being developed now, and improvements are being made to existing batteries. There are infrastructures in place to handle lead-acid, nickel-iron, nickel-cadmium and other existing batteries, but these will need to be greatly expanded to deal with the volume of batteries that will result from EV and HEV deployment. Entire new infrastructures will need to be developed and put into place to accommodate the new battery designs, such as ambient- and high-temperature lithium batteries, metal-air batteries, and high-temperature sodium batteries. Each battery type has its own unique requirements for infrastructure support. As battery research and development continues and test results add to the knowledge base, infrastructure requirements will be defined. The Federal Transit Administration's programs incorporate several battery technologies, including lead-acid and nickel-iron batteries in the TEVans with the Chesapeake program, nickel-cadmium batteries in the New York Hybrid buses, and a sodium-sulfur battery in a CALSTART electric bus. Infrastructure requirements and power availability studies are also part of the Advanced Lead Acid Battery Consortium program.

### **Fuels**

HEVs will use different kinds of fuels for their heat engines. Some EV charging stations may also use heat engines to generate electricity for opportunity charging. Careful consideration must be given to developing the infrastructures for alternate fuels, as each has its own special requirements. The Energy Policy Act of 1992 requirements may result in as many as one million alternative fueled vehicles being sold to fleets by the year 2010 [10]. The required infrastructures for these vehicles will develop as the vehicles are purchased and deployed, and should be easily expanded to meet the needs of HEVs and EVs as they are introduced into the market. The Federal Transit Administration is involved with many

alternative fueled vehicle programs in the transit industry, including ethanol and methanol buses, compressed natural gas (CNG) and liquefied natural gas (LNG) programs and other clean fuels programs across the nation.

### **Safety**

Extensive safety education programs for federal, state and local government personnel need to be defined and implemented as part of infrastructure support for emerging technologies. Fire departments will need to know how to respond to fires and accidents involving many different kinds of fuels and chemicals. Emergency medical technicians will need to be trained to handle new situations. Civil defense and police are going to need training in responding to different situations that arise from the storage and use of new fuels and batteries.

### **Fleet and transit applications**

The most likely initial market for EVs and HEVs is expected to be vans and small delivery vehicles. Los Angeles, for example, has considered ordinances that would restrict the use of internal combustion engine delivery vans, thus creating an entry market for ZEVs in that city [11]. Many utility companies have programs that use these type vehicles; EPRI has recently coordinated a program using fifty Chrysler TEVans, the first production EVs from a major U.S. automaker [12]. The Energy Policy Act of 1992 mandates that certain fleet operators purchase alternative fueled vehicles, including EVs and HEVs, according to strict timetables.

The infrastructure requirements for centrally fueled fleets and transit operations will be significantly easier to meet than those for the general public. These vehicles operate within known areas, are centrally garaged and maintained, and are driven by professionals. Recharging and refueling facilities for EVs and HEVs can be located at the central parking/maintenance facility and at controlled points along the routes served. Access to these facilities would be controlled and would, in general, not be open to the general public. Through existing alternate fuel programs, many fleet and transit operators have experience deal-

ing with fuels other than gasoline and diesel.

Because many of these vehicles operate during the day, it may be advantageous to incorporate peak shaving methods in the design of recharging stations. Storage batteries, flywheels, ultracapacitors and other energy storage devices could be charged during off-peak and provide energy to EVs and HEVs when needed.

Fleet and transit operations also offer the potential to exchange spent batteries for fully charged ones (remove and replace). Battery swapping would allow for off-peak charging of batteries. Safety training programs would need to be enacted, as would design and implementation of an expanded battery recycling program to handle the increased number and type of batteries. Battery manufacturers, automakers and fleet operators would need to work together on acceptable designs for batteries, storage facilities, and handling equipment.

Connector development for fleet and transit operations also needs to be standardized, but this should not present a major problem. Mechanical versus inductive coupling needs to be determined.

As more and more knowledge of the requirements for EV and HEV fleet and transit operations is gained from existing programs, infrastructure requirements will become better understood and defined. One example is the Santa Barbara electric bus program. Buses were routinely running out of charge short of their anticipated ranges; after implementing an extensive driver training program, buses are now returned at the end of their runs with as much as thirty percent charge remaining. Education and training programs such as these will have to be developed and continuously refined as each new technology matures.

### **Personal vehicles**

The more difficult market to develop and implement an infrastructure for will be the personal EV and HEV market. There have been a number of studies performed to determine the initial market for the new vehicles; profiles of likely early purchasers and users are beginning to be better identified and understood [13].

The existing infrastructure, which supports internal combustion engine vehicles, is widespread and accepted by motorists; if you plan to drive

your automobile across the country, you know that you will be able to refuel just about anywhere you go, whether you use unleaded gasoline or diesel. Similarly, if your vehicle breaks down or runs out of fuel, you can obtain repairs and roadside assistance even in remote areas of the country. This same confidence in the ability to recharge or refuel EVs and HEVs or to obtain emergency repairs or roadside assistance regardless of where you are is absolutely essential. Without a reliable and comprehensive infrastructure, the general public would be reluctant and hesitant to accept EVs or HEVs as being equal to the current internal combustion engine vehicles, especially since EVs and HEVs will most likely cost more to purchase.

### **EV recharging at home**

The bulk of EV recharging will initially take place at the owner's home [14]. Even though the existing electric generation, transmission, and distribution capacity is able to handle this, a number of other infrastructure concerns must be addressed. Connectors must be standardized. Building codes across the country must be reviewed and revised as necessary to allow for home rechargers. Battery charger designs must be coordinated with vehicle designs; on-board versus off-board control needs to be established. Safe, automatic shut-off controls need to be included. Recharging capability for people who don't own a home but would like to purchase an EV needs to be identified. Utility rate structures need to be reviewed and revised as necessary to promote the sale of EVs; off-peak rate benefits need to be defined.

### **Opportunity charging**

For EVs to become accepted, a nationwide system of opportunity charging must be developed. This would include chargers at work, in parking garages and at on-street parking places, at stores, supermarkets and shops, and in charging locations similar to gas stations. This type of infrastructure will require extensive planning between government, industry and utility members. A great deal of work has begun in this area. EPRI formed the Infrastructure Working Committee to open dialogue and information exchange among all groups needing to participate. Three of the four Federal

Transit Administration's EV consortia are studying rapid recharging and its effect on vehicles, batteries and the utility grid; Baltimore Gas & Electric's Dave Brown, a member of the Chesapeake Consortium, chairs the Infrastructure Working Committee's Health & Safety Committee. It is links like this that will enhance information exchange between concerned parties and expedite solutions to problems as they arise.

Safety issues relating to opportunity charging must also be carefully studied. EV owners will have to be absolutely convinced that it is safe to recharge an EV, regardless of where they are, what the weather is like, what kind of EV they drive, and other considerations. Electromagnetic field exposure, too, must be studied; a national standard for measuring this effect both on-board vehicles and in and around charging locations needs to be established.

Vehicle charger connectors must be standardized, the same way that gasoline tank inlets and fuel station nozzles are. Research needs to be continued to determine whether direct coupling or some form of inductive coupling is the preferred way to access recharge power. Inductive coupling could be accomplished simply by parking the vehicle over the primary winding or by attaching a hand-held primary to the vehicle.

Impacts on the utility grid will need to be carefully studied. EVs may cause power quality problems; vehicle designs now can take this into consideration, whereas existing electric customers will need to be assured adequate power quality will continue to be available as more and more EVs are added to the grid.

Opportunity charging stations require extensive analysis and research to maximize their usefulness and acceptance and minimize their impact on the utilities and their neighbors. Community acceptance will require proper planning and marketing. Peak-shaving or load-leveling schemes must be worked out. Rate structures will have to be reviewed and revised as needed, as will methods of billing for electricity used.

### **Public awareness**

The most critical part of successfully marketing EVs and HEVs may be how convenient and reliable the supporting infrastructure can be made.

More often than not, people's perceptions of EVs improve after they have driven one; ride and drive events are excellent marketing tools. The CAL-START and Chesapeake EV programs both include extensive public awareness activities; the Chesapeake program has already conducted more than sixty EV demonstrations, reaching more than 50,000 people. These kinds of activities can also be used to collect market data to improve forecast models.

One of the goals of the Advanced Lead-Acid Battery Consortium EV program is the development of a state-of-charge indicator for lead-acid batteries. With further development, this technology would enable a generic "gas gauge" for EV use regardless of the type of battery used. Consumer studies have shown that drivers are more comfortable with an indication of remaining miles on available charge than with other information displays [13].

### CONCLUSIONS/SUMMARY

The American way of life has developed around the automobile. The unprecedented freedom and mobility afforded by safe and economical transportation has helped shape our culture. Personal and public transportation allows people to live in suburban communities and commute to work where the majority of jobs are: the urban centers. However, this freedom has not come without a hefty price tag. Urban air quality problems persist and increase. Our dependence on foreign energy sources decreases our energy security and adversely affects the balance of trade.

The introduction of increasing numbers of EVs and HEVs into our transportation system will be a significant part of the solution to many of the problems associated with internal combustion engine vehicles. EVs and HEVs will lessen air pollution; inasmuch as very little electric power is generated in the U.S. by burning oil, EVs and HEVs will help reduce our dependence on foreign oil and thus increase our national energy security. Quality U.S. jobs will be created to design and build the vehicles and their subsystems and components and the infrastructure facilities to support them; many of these jobs will offset work force reductions due to defense spending cuts.

EVs and HEVs may soon be a very substantial

part of our daily lives. How successful they will be will depend, in large part, on how well all of the necessary infrastructure requirements are defined, developed and implemented. An undertaking of this magnitude requires that federal, state and local government agencies, utilities, automobile manufacturers and suppliers and many others work together to make it happen.

### REFERENCES

- [1] Electric Transportation Coalition, "Electric Vehicles: Projected EV Sales Cited," *Green Car Journal*, September 1993, p. 102.
- [2] Bevilacqua-Knight, Inc., "Commercializing Electric Vehicle Issues, Barriers, Solutions; A White Paper," 501 Fourteenth Street, Suite 200, Oakland, CA 94612, February 1993, p. 5.
- [3] S. C. Davis and S. G. Strang, *Transportation Energy Data Book: Edition 13*. ORNL-6743, Oak Ridge National Laboratory, Oak Ridge, TN, March 1993, p. 2-13.
- [4] U.S. Department of Energy, *16th Annual Report to Congress for Fiscal Year 1992*. Assistant Secretary, Energy Efficiency and Renewable Energy, Office of Transportation Technologies, Washington, DC, August 1993, p. 1.
- [5] Motor Vehicle Manufacturers Association of the United States, *MVMA Motor Vehicle Facts & Figures '92*, Detroit, MI, p. 25.
- [6] EA Engineering, Science, and Technology, "Electric Vehicle Policy Perspectives and Pathways to the Year 2010," prepared for the Congressional Research Service, Arlington, VA, April 1992, p. 12.
- [7] Electric Power Research Institute, "The Transportation Program: Transportation Infrastructure Research Plan, 1993-1997," Palo Alto, CA, pp. 7-8.
- [8] T. S. Yau, "Will Utilities Have Adequate Generation, Transmission and Distribution Capacity to Support Electric Vehicles?" in *Proceedings: The National Electric Vehicle Infrastructure Conference*, December 1992.
- [9] Intermodal Surface Transportation Efficiency Act of 1991, Public Law 102-240, Title VI, Part C., Sec. 6071-6073.
- [10] United States Department of Transportation, Federal Transit Administration, *Technical Assistance Brief 5*, Office of Technical Assistance and Safety, Washington, D.C. 20590, Spring 1993.

- 
- [11] United States Department of Transportation, National Highway Traffic Safety Administration, *Federal Regulations Needing Amendment to Stimulate the Production and Introduction of Electric/Solar Vehicles*; A Report to Congress, Prepared in consultation with the Environmental Protection Agency and the Department of Energy, Washington, D.C. 20590, January 1990, p. I-10.
- [12] S. Hoffman, *Summary of the 1992 National EV Infrastructure Conference*; prepared for the Electric Power Research Institute, TR-102422, Project 3272 Final Report, Santa Clara, CA, May 1993, p. 3-1.
- [13] T. Turrentine and D. Sperling, "How Far Can the Electric Vehicle Go on 100 Miles (162 km)?" in *OECD Documents, The Urban Electric Vehicle, Policy Options, Technology Trends and Market Prospects*, Paris, France, 1992, pp. 259-269.
- [14] R. E. Balzhiser, Remarks, in *Proceedings: The National Electric Vehicle Infrastructure Conference*, Electric Power Research Institute, TR-101892, December 1992, p. 10.



## ELECTRIC AND HYBRID ELECTRIC AUTOMOBILES IMPERATIVES FOR COMMERCIAL SUCCESS

C. Marks

Visiting Professor, College of Engineering  
University of Michigan  
Ann Arbor, MI 48109

### ABSTRACT

The task of making and selling electric or hybrid electric vehicles in large volume as a commercial endeavor faces many difficulties. Some are technical but many are not. To understand these issues, a qualitative overview of the automobile business in the U.S. is presented together with a description of the way in which innovation occurs. This overview establishes the broad scope of the task. It is argued that, in addition to progress on generally acknowledged technical difficulties, success will require a well orchestrated systems approach which addresses the entire range of problems. Some important, illustrative research and development considerations for the system are discussed and the potential use of purchase incentives to aid the introduction of such vehicles is noted.

### INTRODUCTION

The technical feasibility of building operational passenger cars powered by electric or hybrid electric power plants has been demonstrated many times, spanning a period of decades. Currently, many major efforts are ongoing to develop components and to build and evaluate the operational characteristics of cars employing a variety of competitive electric power train arrangements. These recent efforts have shown substantial progress compared to earlier developments. However, a demonstration car, even one that performs very well, is but the first step in establishing the feasibility of manufacturing and selling a large volume of such cars. This task faces great difficulties. The difference between what is often referred to as, "technical feasibility" and the suitability of a car for mass production, are the subject of this paper.

The goal is to make and sell electric or hybrid electric vehicles in the United States in large volume, in order to have a significant impact. To do this successfully, these cars will have to compete directly with traditionally powered vehicles. This means meeting the transportation needs of a significant proportion of our present and future car owning population better than competitive de-

signs. Our economic system also requires that this endeavor be commercially successful, i.e., that it conform to traditional business parameters that provide for amortization of the development and investment costs incurred as well as generating a profit and reasonable return to the shareholders of the businesses involved.

### MARKETING NEW CARS

Customers buy cars, and the decisions of millions of potential customers will determine the success or failure of the task described. To understand how to make electric cars a commercial success, it is instructive to examine a simple description of some of the marketplace fundamentals for new cars.

Existing passenger cars have established a very high standard for many fundamental characteristics, most of which are absolute imperatives in the minds of new car customers. Success requires that the "voice of the customer" be heard and appropriate responses generated. The quality, comfort, safety, reliability, durability, maintainability, serviceability, mission flexibility and functional operating capability of our passenger cars are at a very high level. Any product not perceived by customers to be competitive in these characteris-

tics can not hope to achieve substantial market penetration.

This does not mean that all cars are equal in these characteristics. Rather, it means that today's production cars exhibit variations above a very high baseline that has risen to this level mostly by small incremental improvements over many years. Car customers' purchase decisions certainly are related to their perceptions of differences in these fundamental characteristics as well as their valuation of such things as aesthetics and detailed comfort and convenience features. History provides many examples of car models that have quickly lost market share and gone out of production because new car buyers perceived them to be significantly deficient in one of these fundamental characteristics, that is, they fell below the acceptable baseline.

In the United States, most new cars are sold to people who already own one or more used cars. For most of them, their existing car operates perfectly well or is readily serviceable. Customers buy new cars for many reasons. Some of these reasons are value judgments, such as a perception of the economics of maintaining the old car versus increasing car payments, or a change in transportation needs. Others may be emotional: a desire for an image, new styling or features, or just the fact that the new car is more fun to drive.

Key to the purchase decision for most customers is the fact that a ready market exists for their perfectly good used car and, therefore, they can satisfy their desire for a new one with an outlay that is a fraction of the purchase price of the new product. Of course, in addition to buyers who trade in a car at the time of purchase, the market for new cars includes first time car buyers and those who are increasing the number of cars they own. The key point to note, however, is that the competition for any new car being introduced is not just other competitive new car models, it is the existence of an abundance of perfectly serviceable used cars.

## **BASIC PARAMETERS OF THE CAR MANUFACTURING BUSINESS**

### **Scale**

One of the most obvious characteristics of the car manufacturing business in the U.S. is its scale. It

has been estimated that about one out of every seven jobs in this country owe their existence to the automotive industry. Automobiles are ubiquitous. Familiarity with them tends to hide the magnitude and complexity of the processes used to design, develop, tool, manufacture, assemble, market, sell, insure, maintain, repair and eventually disassemble and recycle a large proportion of them. The number of establishments is huge. In the U.S., in addition to the traditional manufacturers and transplants, there are over 1200 first tier suppliers and 30,000 sub-suppliers; a complex fuel exploration, production and distribution system, including over 100,000 gasoline service stations; plus sales and service operations provided by over 40,000 dealers and more than 200,000 independent establishments. Substantial changes in one part of this system can have far reaching and sometimes unexpected effects elsewhere.

Most people recognize that there are significant economies of scale in the car manufacturing business. Small manufacturers survive and profit by selling niche vehicles, but their costs will not allow them to achieve significant penetration in a 14 million vehicle per year market. Car manufacturing is a tooling intensive business, requiring massive investment. A new car program, today, can cost one to three billion dollars. Even minor changes can cost hundreds of millions of dollars.

### **Lead Time**

Because of the size of the endeavor and the complexity of both the product and its manufacturing processes, changes involve a significant lead time. It is not unusual for five to seven years to elapse between management's commitment for a new model and its arrival on the showroom floor. This lead time, combined with the large investment required, results in a very high risk of making financially catastrophic decisions. Market conditions can easily change during the lead time involved. When these changes are not anticipated, sales will not be as expected and the manufacturing plant capacity both for final assembly and throughout the supply chain, will not be appropriate. Major dislocations and economic loss result from too much capacity. Too little capacity results in lost potential sales and cannot be remedied quickly. In addition, the wrong car for market

conditions is a disaster for dealers who, typically run a small business highly dependent upon volume sales.

Many conditions affect the market for new cars because, for most people, the decision to buy a new car is a significant financial commitment and can be easily postponed. General economic conditions, trade policy and government regulations, among other things, can dramatically affect the general car market and, even more, the acceptance of particular models. The most significant example of such an effect was the 1973 oil embargo that inverted the market demand between large and small cars almost overnight, creating severe economic dislocations.

### **Externalities**

The existing 145 million car population is supported by a massive infrastructure, including a fuel supply system, maintenance and repair facilities, roads, parking and an insurance system. New vehicle designs must either fit the boundary conditions imposed by this infrastructure or changes in these systems must be orchestrated before the new product can be successfully introduced. The introduction of catalytic converters is an example of this process. The petroleum industry had to change refining and distribution facilities to produce unleaded fuel and mines had to be dug in South Africa and Russia to produce more platinum before these devices could be introduced.

Other major factors external to the car manufacturing business that establish boundary conditions for car design, include federal, state and local municipality regulations, the product liability environment and the views held by various advocacy groups. Any of these factors may have a profound effect on the automobile manufacturers' ability to change car design parameters or to introduce different manufacturing processes.

### **Engineering**

Engineering tasks for the car manufacturing business are performed within the framework described above. Engineering must provide designs and manufacturing processes to produce automobiles that meet or exceed high customer expectations and satisfy all of the other system boundary

conditions. These designs and processes must result in a unit cost and up-front investment that is commensurate with the customer perceived value of the car and which satisfies the financial parameters of the business enterprise.

Because of the major down-side economic risks involved in any new car program, predictability of the performance of both product designs and manufacturing processes is a very high priority. If this predictability is not established before production begins, the engineering function runs the risk of sinking the entire business.

Other specific engineering boundary conditions include meeting safety, fuel economy, noise and emissions regulatory requirements. These must be reconciled with customer expectations regarding quality, performance, fuel economy, safety, reliability, durability, serviceability and maintainability.

### **INNOVATION IN THE CAR BUSINESS**

The marketing and manufacturing parameters outlined above clearly present some major challenges to product innovation in the car business. The risks of innovation are high, the consequences of failure can be dramatic, and satisfying the imperatives is difficult. Timing of the process makes it impossible to know if the all of the boundary conditions have been met before huge financial commitments must be made. Nevertheless, car components and basic designs have changed dramatically over the years. The marketplace demands such change, and this fact has developed mechanisms that do satisfy the parameters and adapt vehicles to a continually changing set of market requirements. The only way to survive and prosper in this business is to master this change process and do it better than the competition.

The basic elements of the innovation process are essentially the same whether the change involves a small component or the introduction of an entirely new car. They include the following steps:

- Identifying a customer perceived value for the change
- Conducting a concurrent, iterative development process embracing: marketing, concept generation, design, prototype construction,

testing, tooling, validation, cost analysis, procurement, manufacturing processing and operations, logistics, maintenance and repair

- Risk assessment judgment and decision making regarding: the technical and business risks, how the customer will assess value versus cost, how well the predictability and externality requirements have been satisfied, and the best introduction strategy
- Effective education of potential customers regarding the benefits of the changed product and promotion of its sale
- Monitoring results by comparative sales, profitability, and field performance of the changed product
- Introduction of improvements based upon field experience

Over this entire change process hangs the potential threat of calamitous product liability litigation. On the one hand, manufacturers have been sued simply because their designs were different from others in the industry. On the other hand, suits have contended that since a design was changed, the previous design must have been deficient. The complexity of cars makes defense of such suits extremely difficult.

Historically, the marketplace has rewarded a path of evolutionary change based upon how well this overall process is executed. The more extensive the change, particularly if it involves basic functional components, the more diligence in the development process is required to reach a reasonable risk versus reward tradeoff. This, then, is a framework within which the research and development agenda for electric and hybrid electric automobiles may be viewed.

### **ELECTRIC AND HYBRID ELECTRIC R&D**

In deciding what problems need to be resolved for "commercial success," it can not be emphasized too much that the total system must be considered. The primary system includes the large number of manufacturers and their suppliers and dealers, plus the fuel production and distribution and

service operations that were noted earlier. It is interlinked with processes, attitudes, and procedures that have evolved over many years so that it works extremely well. Any major change runs the risk that it may dislocate one or more of the parts, or the upset the interfaces between them, either of which might jeopardize the success of the entire transition endeavor. Such changes also must face the challenge of getting through the thicket of concerns of the legal liability system, various advocate groups, and the insurance companies, as well as regulators at the federal, state and municipal level.

The introduction and sale of electric or hybrid electric powered automobiles on a large scale will require changes in this transportation system that are unprecedented in both magnitude and scope. To be successful and sustainable, the new system elements and the transition to them must be orchestrated very carefully. Otherwise, the customers simply won't be there.

One way to look at this task is to first enumerate the research and development that will be needed to assure that no "show-stoppers" remain. The previous discussion indicates that this research and development must extend well beyond assuring that the functional requirements for electric and hybrid electric power trains can be met. Some illustrative, important considerations worthy of significant effort are listed below under the categories discussed earlier.

### **Externalities**

The energy source presents a real dilemma. Any new energy source, its distribution system, and the vehicle service capability, including both facilities and trained people, need to be developed and put in place before a large number of customers will commit to buy a car that is dependent upon this source of energy. This is a "chicken and the egg" situation that needs an innovative solution if a rapid transition is to be achieved. A slow transition would be easier, but this raises another dilemma. If the vehicle production volumes are too low, costs will be high and the demand reduced enough to jeopardize the transition. The crux of the basic dilemma is that the business incentive to put a major new energy supply, distribution and service system in place will not exist without a

broad base of demand (a lot of cars) and cars requiring such a system can not be sold in volume, if the energy is not widely available.

The importance of orchestrating appropriate standards must not be overlooked in establishing such a new system. Proliferation of products and the details of the interfaces in the system can dramatically slow or halt the transition. Without standards, critical resources, which are needed to design and develop the product, are wasted to accommodate the system variation. On the other hand, standards set too early in the development process run the risk of stifling creativity and locking in obsolete technology. Either situation will delay the transition by decreasing customer value.

Another challenge to the concept, research, design and development process is to anticipate and try to mitigate potentially adverse reactions of the product liability establishment, insurance companies, regulatory bodies, and various advocate groups. Early anticipation of such reaction can help to minimize cost and delays in implementation and might even prevent a last minute "show stopper."

### Engineering

The engineering research and development needs of any new car, for the most part, are evident from the earlier listing of customer imperatives and engineering task parameters. Competitive, "baseline" levels must be achieved for basic functions: safety, emissions, mission flexibility, reliability, appearance, quality, comfort, noise, odor, durability, maintainability, serviceability. These are all a critical part of what customers regard as value. Regardless of cost, large volume sales will not be possible if a vehicle fails to achieve an acceptable level of any of these functions.

As indicated earlier, predictability, the ability to assure with reasonable confidence that these characteristics will be achieved, is of utmost importance. For traditional designs and processes, this predictability is established by extensive analysis, simulation, and testing of components and sub-systems, and by building prototype and pre-production vehicles. Tests are performed in laboratories and on test tracks, as well as on the public roads, each venue providing additional assurance of the suitability of the design. This work is aug-

mented and supported by an extensive knowledge of what has and has not been satisfactory in past production vehicles. Such knowledge is a crucial element in both the design and the validation program.

For an electric or hybrid electric car this product validation process must be carefully developed. It is more difficult and requires special consideration because of the lack of previous field experience, which makes increased risk inevitable. Each element of the product or production system that lacks precedence needs to be carefully examined with all of the analytical tools available, and new testing techniques must be devised, as required, to maximize the probability of success. Some illustrative qualitative criteria for a few of the parameters are listed below:

- **Safety:** Federal Motor Vehicle Standards comprise a necessary but far from sufficient set of criteria to assure that a car will perform in a safe manner. Meeting these standards is certainly no defense in product liability cases. New designs must anticipate extremely unlikely and unexpected events in order to avoid potentially disastrous field failures. Such failures can destroy customer confidence in a product (or even a company) in addition to costing hundreds of millions of dollars for compensation and legal fees. Some vehicles operate in very unusual environments and encounter incredible operating conditions. With 145 million of them on the road, a very small fraction of failures can be totally unacceptable.
- **Durability and maintainability:** The same statement with regard to operating conditions applies. Maintenance requirements for recent model cars have been reduced to very low levels and many cars today remain functional for 10–15 years even though their owners fail to perform the maintenance recommended. In addition, there is legal precedent for expecting cars to function as the driver expects, not only under extreme conditions but when subjected to "foreseeable abuse."
- **Disassembly and disposal:** The ultimate goal is recyclability. A very high percentage of the

content of existing designs can be economically disassembled and recycled without undo hazards and the same will be expected of new designs.

### **Lead Time and Operating Scale**

Very long lead times are inherent in the development process for a totally new car. This fact, and the large scale of the operations required, puts a very high premium on agility. Research and development that can reduce the lead time and increase the flexibility of the production processes will increase the variety of products that can be produced economically. Flexibility and shorter lead times can reduce substantially the risk of bringing a new car to market. To be effective, this task must be addressed from a system standpoint, including the entire chain from the acquisition of basic resources to the final assembly and distribution of the vehicles. Considerations of flexibility and lead times should enter into the early design and development stages of both the product and its manufacturing processes.

### **INTRODUCTION STRATEGY**

The uncertainties of introducing electric or a hybrid electric cars would not be eliminated, but would be greatly reduced, if they were completely interchangeable with current designs in function, cost and all of the other dimensions described in this paper. Current technology, however, results in designs with significant cost and functional deficiencies and major infrastructure questions.

It has been proposed that the introduction of electric or hybrid electric vehicles could be hastened by providing various non-market incentives that would overcome some of these shortcomings. This is one way to help to get the infrastructure established and to obtain some data needed to improve predictability, as well. This approach has merit, provided the cars so introduced represent an acceptable level of risk and there is a clear path toward designs that will be supported in the marketplace without such incentives. Otherwise, the cost of such a subsidy, over time, will rise to an unacceptable level. This will prohibit substantial market penetration and the economies of scale will never be realized.

Mission flexibility is one of the key drawbacks of current electric battery vehicles, a limitation that is being addressed by hybrid electric designs. Much remains to be learned about the importance of mission flexibility to the potential customers of such vehicles. If it is a critically important factor for a majority of potential buyers, then, other factors being equal, the hybrid approach will have much greater market acceptance than the battery only system with current technology. If a large percentage of buyers will accept the mission flexibility limitations of the current battery only cars, this will greatly hasten the transition.

Unfortunately, marketing studies are of only limited value in answering such questions. Test marketing well developed vehicles can provide some of the answers, but ultimately, this answer must come from the marketplace. This reasoning suggests an observation regarding the use of non-market incentives. If they are employed to hasten the introduction of such vehicles, it would be worth trying to structure them so that they are neutral relative to the battery only versus the hybrid approach. Then, with both types of vehicles being sold, real market information would be available, which could be used to guide future developments.

### **CONCLUSIONS**

The process of developing and introducing electric or hybrid electric vehicles as a commercial venture is an exceedingly complex, high risk endeavor, not unlike efforts to develop oil shale or nuclear power. A huge financial investment is required to develop and produce such vehicles on a significant scale and many uncertainties regarding their acceptability remain.

New car customers have extremely high expectations that may not be able to be satisfied with these power trains. In addition, the process of validating such a radically new design is complicated by the absence of baseline data on comparable vehicles currently in operation, increasing the risk of unanticipated field failures.

Another major consideration is the significant infrastructure changes that will be needed to sustain this different kind of car in the field.

Reducing the risk of this endeavor is imperative if it is to become a commercial success. The entire

affected system should be addressed in a comprehensive way in order to move forward efficiently.

A broad range of research and development must be performed successfully to eliminate potential "show stoppers" before committing major resources to significant production volumes.

The timing and role of potential incentives and regulations should be carefully considered. Incentives could reduce the risk substantially. On the other hand, if incentives and regulations result in the production of vehicles that are judged inadequate by the marketplace, customers may reject this technology for a long time to come.

## ADVANCED BATTERY COMMERCIALIZATION

J. Williams  
General Motors Corporation  
Troy, MI 48007

### ABSTRACT

The General Motors Impact program and PrEView Drive are reviewed. An overview of recent US Advanced Battery Consortium activities is also presented.

### IMPACT PROGRAM AND PREVIEW DRIVE



Figure 1.

#### Consumers to PrEView Impact

General Motors and leading utilities throughout the United States will provide 1,000 consumers with the opportunity to test drive a GM Impact electric vehicle, similar to the prototype Impact pictured here, for periods of two or four weeks, beginning in spring 1994. The two-year PrEView Drive will encourage development of the service and charging infrastructure needed to support electric vehicle use, demonstrate electric vehicle technology and provide valuable engineering data.





Figure 2.

### **Impact Meets Federal Braking Standards**

The icy, snow-covered roads at the General Motors Kincheloe Winter Test Site in Kinross, MI, have some of the slickest surfaces a car may ever travel. That's why GM takes its vehicles there for brake and traction control development.

The Impact electric vehicle is no different. With all-new regenerative and electro-hydraulic brake technology, it must meet the same standards required of every vehicle on the road. Testing at Kincheloe ensures the Impact can meet Federal Motor Vehicle Safety Standards and validates the design of the electric car's anti-lock brakes, traction control and regenerative braking. Regenerative braking recharges the battery pack in stop-and-go driving.

GM is testing the Impact's brakes in preparation for a 50-car build this fall.

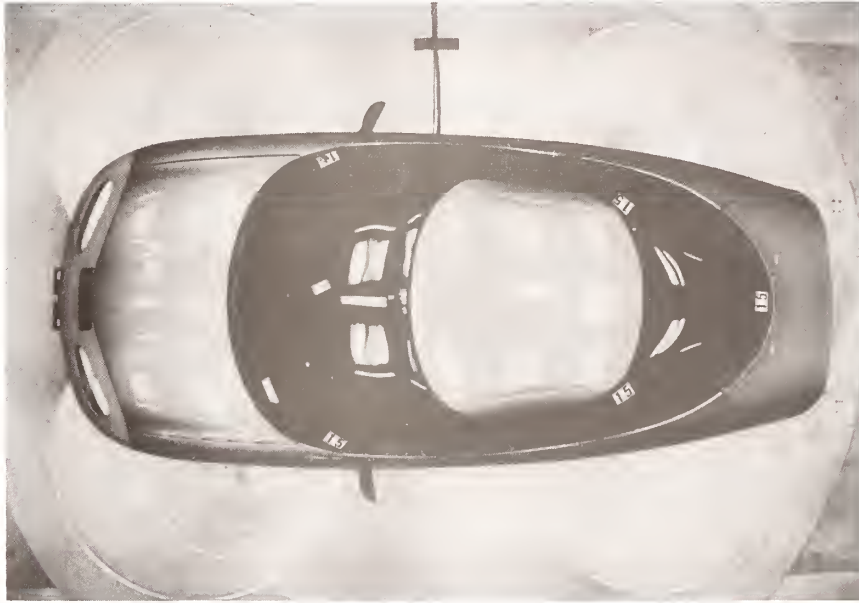

Figure 3.

### **Impact's Aerodynamic Development**

General Motors uses its aerodynamic experience with both auto racing and production vehicles to make the Impact electric vehicle the most aerodynamic production car ever. By giving the Impact a teardrop shape, GM was able to produce a drag coefficient of 0.19 in the wind tunnel. That is 30 percent better than any other production car and comparable to an F-16 fighter jet.

GM is testing the Impact's aerodynamics in preparation for a 50-car build this fall.



Figure 4.

### Impact Heat Pump Keeps Things Cool

General Motors' Harrison Division in Lockport, N.Y., is testing the efficiency and dependability of the first automotive application of an electrically driven heat pump climate system on the Impact electric test vehicle.

In the climatic tunnel, technicians use solar spectrum lights to duplicate the effect of a car sitting in direct sunlight for an extended period of time. When the vehicle's interior reaches intense heat stages, the Impact's electric heat pump is engaged and GM technicians time how long it takes the air conditioning unit to return cabin temperatures back to a comfortable level. They also lower temperatures below freezing and test how long it takes the heat pump to again bring the cabin temperature to a comfortable level.

Since the climate system is powered by the vehicle's batteries and not an engine, it must be ultra efficient to control the cabin temperature without shortening the vehicle's range.

GM is testing the Impact's climate system in preparation for a 50-car build this fall.



Figure 5.

#### **Aluminum Structure Withstands Crash Testing**

Barrier crash testing takes on new significance when the car being crashed is electric. The Impact's lightweight, welded and bonded aluminum structure, a first for General Motors, is designed to meet the same Federal Motor Vehicle Safety Standards that apply to conventional vehicles. Not only does it have to perform and protect in a 30-mph crash, but it also must support and retain 1,100 pounds of batteries. As an additional safety feature, the vehicle's high-voltage battery system will automatically disconnect in various crash situations. The Impact also includes driver- and passenger-side air bags to ensure occupant safety.

GM is testing the Impact's crashworthiness in preparation for a 50-car build this fall.



Figure 6.

### Impact Conquers Belgian Blocks

The “Belgian Blocks” at the General Motors Milford Proving Ground simulate the worst-case road conditions a vehicle can experience in a lifetime. GM calculates the average number of times a car rides over severe road conditions during real-world driving, then parlays the results into tests.

The Impact electric vehicle is tested on the “Belgian Blocks” to help develop the durability of its lightweight bonded and welded aluminum structure, suspension and motor mounts. The car must meet the same testing standards and reliability expectations as any other vehicle.

GM is testing the Impact’s durability in preparation for a 50-car build this fall.

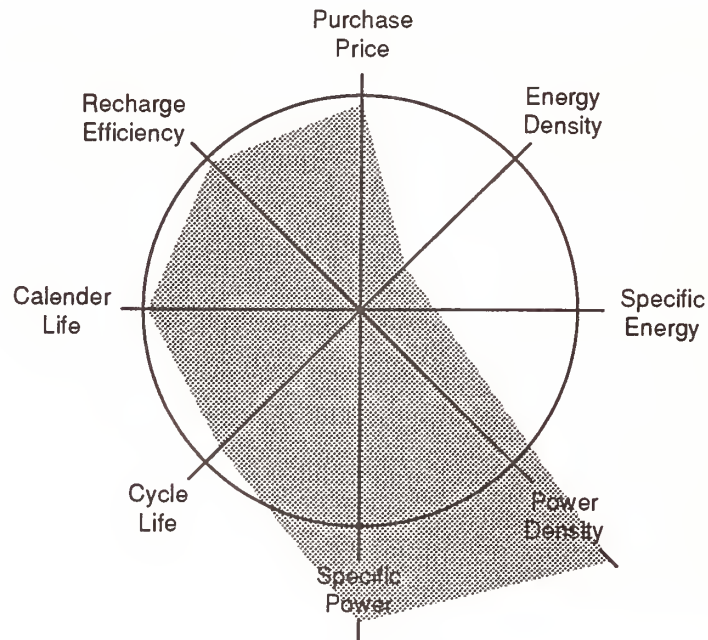

Figure 7. Available batteries have low energy.

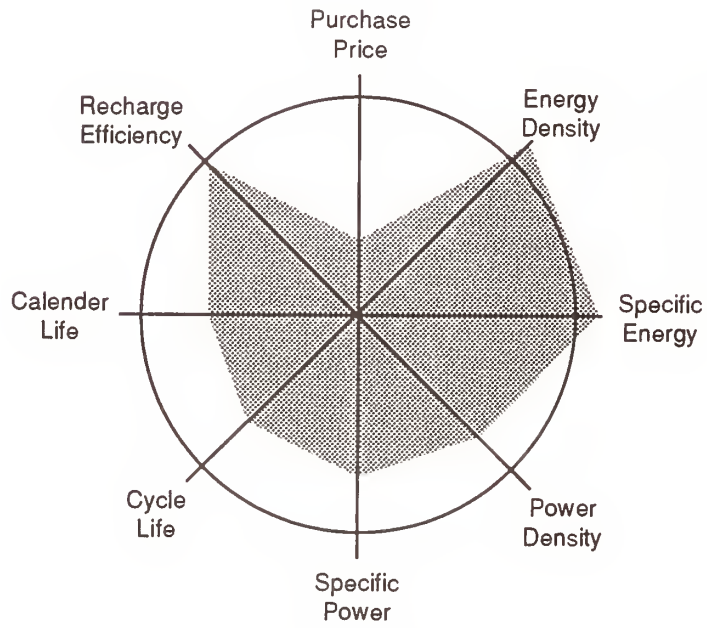

Figure 8. High-energy batteries are expensive.

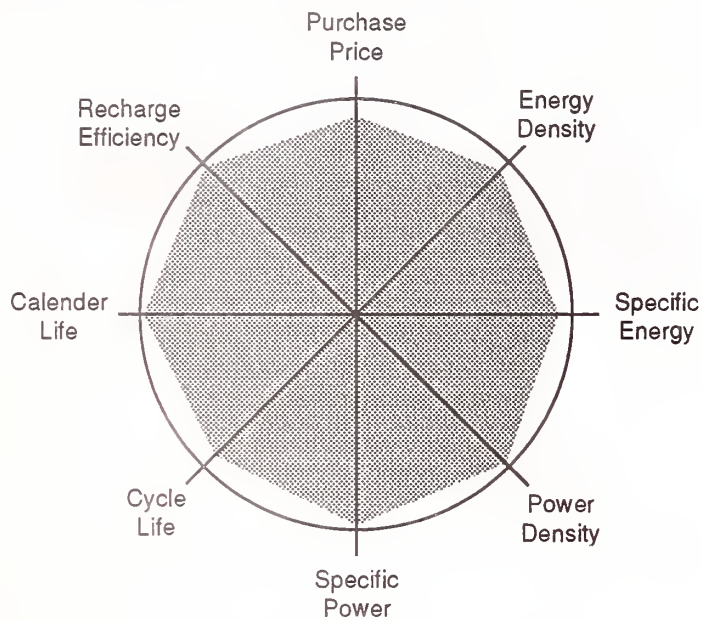

Figure 9. Optimizing the battery system.

### OVERVIEW OF USABC ACTIVITIES

#### Purpose

To develop for commercialization advanced battery systems that will provide increased range and improved performance for electric vehicle in the latter part of the 1990s.

Figure 10.

### Structure

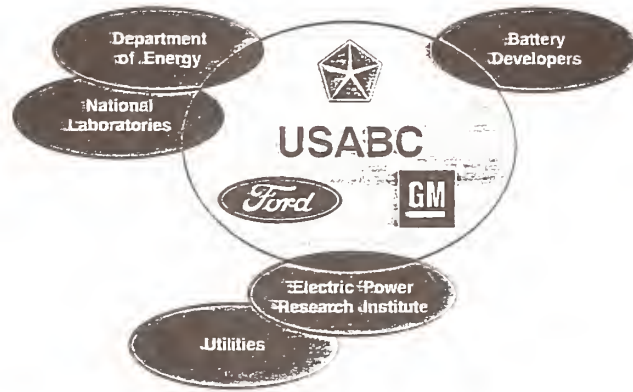

Figure 11.

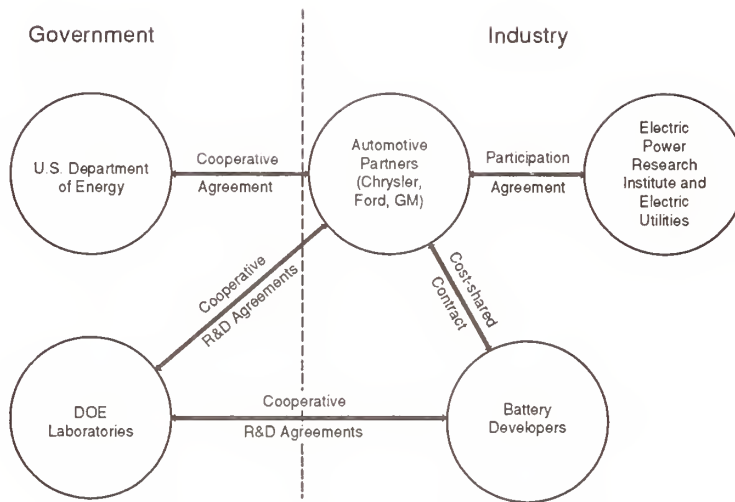

Figure 12. USABC and federal government agreements.



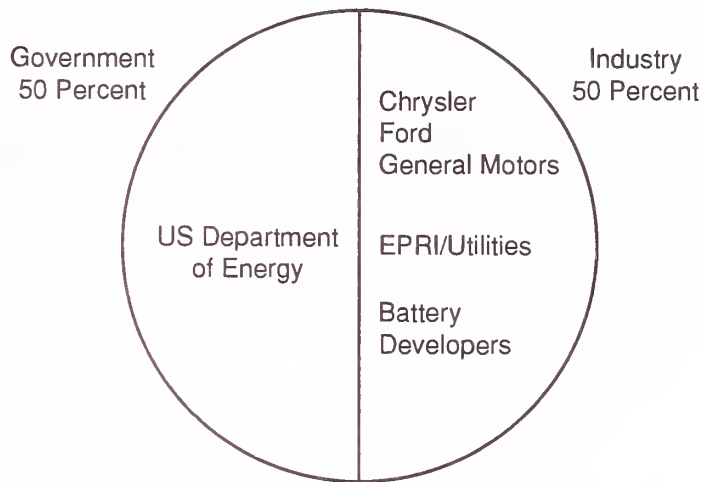

Figure 13. USABC funding \$262 million

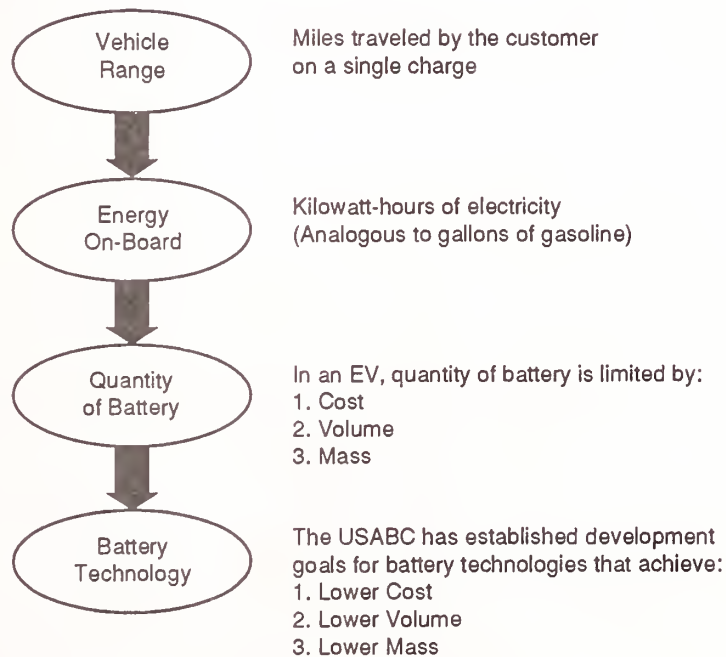

Figure 14. Electric vehicle range.

**Table 1.** USABC development goals

	<u>Nickel Cadmium</u>	<u>USABC Mid-term</u>	<u>USABC Long-term</u>	<u>Gasoline</u>
Purchase Price (\$kW·h)	1000	150	100	.02
Energy Density (W·h/l)	100	135	300	8,800
Specific Energy (W·h/kg)	55	80	200	12,200

**Table 2.** Battery development contracts

<u>Timing</u>	<u>Company</u>	<u>Technology</u>	<u>Start Date</u>	<u>Budget (Millions)</u>
Mid-term	Ovonic	Nickel Metal Hydride	5/92	19.9
Mid-term	Saft	Nickel Metal Hydride	12/92	18.1
Long-term	Saft	Lithium Iron Disulfide	12/92	17.3
Long-term	W. R. Grace	Lithium Polymer	1/93	27.4

**New USABC Development Contract**

Silent Power, GmbH  
Sodium Sulfur  
Mid-term Goal  
\$12.1 million for 48 months

**Figure 15.**

**Table 3.** Battery development contracts (cont.)

<u>Timing</u>	<u>Company</u>	<u>Technology</u>	<u>Start Date</u>	<u>Budget (Millions)</u>
Mid-term	Ovonic	Nickel Metal Hydride	5/92	19.9
Mid-term	Saft	Nickel Metal Hydride	12/92	18.1
Mid-term	Silent Power	Sodium Sulfur	10/93	12.1
Long-term	Saft	Lithium Iron Disulfide	12/92	17.3
Long-term	W. R. Grace	Lithium Polymer	1/93	27.4

**Table 4.** Cooperative Research and Development Agreements (CRADA)

<u>National Laboratory</u>	<u>Task</u>	<u>Technology</u>
Lawrence Berkeley	Tech. Dev.	Lithium Polymer
Nat'l Renewable Energy	Tech. Dev.	Thermal Enclosure
Argonne	Test and Evaluation	Nickel Metal Hydride
Argonne	Test and Evaluation	Sodium Beta
Argonne	Tech. Dev.	Lithium Iron Disulfide
Idaho	Test and Evaluation	Sodium Sulfur
Sandia	Tech. Dev.	Lithium Polymer
Sandia	Test and Evaluation	Sodium Sulfur

**Table 5.** Performance projections relative to mid-term criteria

PERFORMANCE CRITERIA	UNITS	MID-TERM GOAL	AVAILABLE		MID-TERM			
			Lead Acid	Nickel Cadmium	A	B	C	D
Power Density	w/l	250					✓	✓
Specific Power Discharge	w/kg	150					✓	✓
Specific Power Regen	w/kg	75					✓	✓
Energy Density	w-h/l	135	✓	✓				✓
Specific Energy	w-h/kg	80	✓	✓				
Power-to-energy Ratio	-	-						✓
Calendar Life	yrs	5				✓		
Cycle Life	Cycles	600						
Power and Capacity Degradation	%	20						
Ultimate Price	\$/kW·h	150		✓	✓	✓	✓	✓
Operating Environment	Deg C	-30/65						
Normal Recharge Time	Hours	6						
Fast Recharge Time	Minutes	15				✓	✓	
Continuous Discharge 1 Hour	%	75						

---

## COMMERCIALIZATION

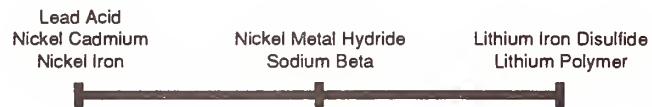

**Figure 16.** Battery technology time line.

### Accomplishments

#### Teamwork

- Establish the framework for cooperation among the stakeholders

#### Tools

- Developed the mid-term and long-term criteria
- Established USABC standard test procedures and initiated testing of advanced batteries

#### Technology

- Negotiated agreements with battery developers and national laboratories
- Focused the battery industry on electric vehicle requirements—business and technical

**Figure 17.**

## ELECTRIC VEHICLE STANDARDS—THE CURRENT STATUS

R. I. Sims  
Ford Research Laboratories  
Dearborn, MI 48124

### ABSTRACT

Since its formation two years ago, the Society of Automotive Engineers' (SAE) Electric Vehicle (EV) Standards Forum has overseen the development of numerous standards for EVs and Hybrid EVs. There are many agencies, both nationally and internationally, that support SAE in this endeavor, and this paper outlines the status of the collective efforts of all those involved in the derivation of standards for the U.S. EV industry.

### BACKGROUND

Throughout the 1970s and 80s those involved with the development and testing of electric vehicles (EVs) became very familiar with one Society of Automotive Engineers (SAE) EV standard, namely J227C, which established a baseline for assessing EV performance and energy consumption. During those two decades there was little additional activity on the standards front other than a proposed draft update to J227C in 1986 that was not adopted, due mainly to a decline in interest in EVs in the early 80s. However, the passage of the California Air Resources Board (CARB) Zero Emission Vehicle (ZEV) legislation in 1990 stimulated a major resurgence of interest in EVs. By late 1990, most of the major vehicle manufacturers active in California had instigated or intensified EV development programs. As the emergent EV industry responded to the CARB legislation, the Motor Vehicle Council (MVC) of the SAE proposed, in 1991, the re-establishing of an EV Standards Committee to support these new industrial ventures. After due consideration, the MVC further recommended that the EV Standards Committee should actually be a Standards Forum established within the Vehicle Systems Standards Group of SAE, with supportive involvement from other SAE standards groups such as the Power train and Electrical Systems Groups and the Maintenance Division. (Fig. 1)

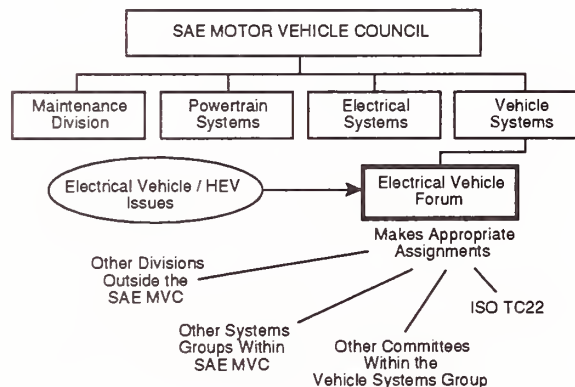

Figure 1. SAE standards groups.

### SAE EV STANDARDS FORUM

As envisioned by the SAE MVC, the role of the EV Forum differs from that of a Standards Committee. The Forum, comprising both SAE members and non-members that are actively participating within the EV industry, addresses the standards needs for both EVs and Hybrid EVs (HEVs), by identifying the areas requiring new or updated standards. It then produces a brief outline of the scope of each area and assigns the standards making task, whenever possible, to existing SAE standards committees, both within and outside the MVC. If no appropriate committee exists, the EV Forum, with MVC approval, can form new standards committees to handle unique requirements.

It was during the autumn of 1991 that the EV

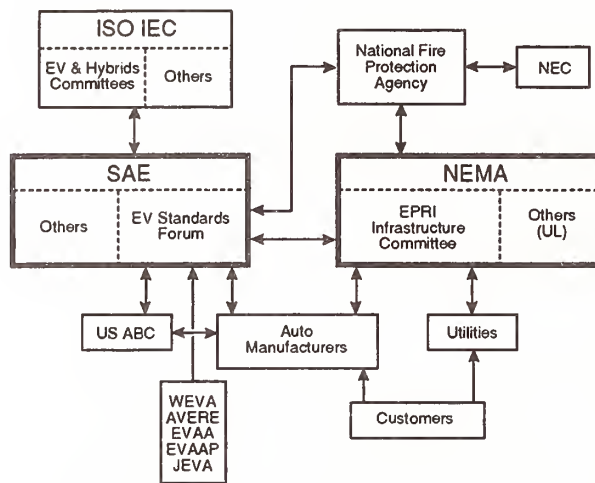

Figure 2. The U.S. standards interface.

Standards Forum had its first meeting and defined its mission statement to be: "To specify standards, or variations of existing ones, which support industry-wide practices for uniform testing, operational flexibility, cost minimization, and consumer safety in EVs and HEVs." The initial membership was modest in number, but now includes nearly all of the major vehicle manufacturers, both U.S. and overseas based. In addition, there are representatives from equipment suppliers, electric utility companies, trade associations, and research establishments. The first meeting also agreed upon a prioritized list of areas that required new or revised standards; these being:

- Battery charging system:
  - vehicle cord and plug
  - charger construction and operation
  - battery watering, venting, and monitoring systems
- EV safety
- EV wiring practices
- EV testing methods (also includes HEVs)
- Vehicle diagnostics
- Service guidelines and battery disposal
- Electromagnetic compatibility:

- susceptibility
- emissions

## U.S. EV STANDARDS ACTIVITIES

Although the American National Standards Institute (ANSI) has requested SAE to take the lead in developing automotive standards, the standards-making process involves many interacting national agencies. As regards the derivation of EV standards, SAE's interface with other organizations is shown diagrammatically in Fig. 2, from which it can be seen that the EV Standards Forum is the focal point not only for automotive EV standards but also for international EV standards liaison and U.S. national EV regulations (electrical codes, etc.).

Since its formation, the EV Standards Forum has been in liaison with all of the organizations shown in Fig. 2 as it pursued the making of standards for the following topics:

- High-voltage wiring charging system and operational (propulsion) systems
- Performance testing methods for ZEVs
- Testing methods for HEVs
- Electromagnetic radiation
- EV batteries

In addition, other tasks undertaken by the EV Forum include:

- Support for National Electrical Code Handbook article
- Liaison with Electric Power Research Institute's (EPRI) EV Infrastructure Working Council (IWC)
- Derive EV Terminology Manual (SAE J-1715)

The content and status (as of October 1993) of each of the above will now be outlined:

### 1. Draft J-1719: High-voltage wiring charging systems

For both this standard and its counterpart, the operational (propulsion) system, two task forces were set up under a parent committee, the SAE Electrical Distributions Standards Committee. The charging systems task force has defined its mission as "To develop a standard for transferring power and information for the purpose of recharging an electric vehicle at low, medium, and high rates." In keeping with this objective, an SAE Technical Information Report (J-1719) is due to be issued during the first quarter of 1994, the contents of which are hereby outlined:

#### 1. Utility Infrastructure Issues:

- (a) Historical perspective
- (b) Generation, transmission, and distribution systems
- (c) Load impact (continuous EV load, on-peak fast-charge, cold-load power-up, rate incentives, management and control, public and private charging)
- (d) Power quality (power factor, harmonic distortion, conducted emissions)
- (e) Communication (present and proposed schemes)

#### 2. Premise Wiring (NEC definition):

- (a) Global power supply considerations
- (b) Standardization and certification
- (c) Charging modes (slow, normal, and fast)
- (d) Charging facilities (private and public)
- (e) Protection and control (equipment protection, people protection, load management, etc.)
- (f) Coupling types (direct conductive and magnetic inductive)
- (g) Operator interface, ergonomics, and other human factors
- (h) Auto docking

#### 3. Vehicle Systems and Issues

- (a) Systems overview and definition

- (b) Power-system diagrams and component hardware description
  - i. DC coupled
  - ii. AC coupled
  - iii. AC-DC hybrid coupled
  - iv. high-frequency coupled (inductive)
- (c) Communication and control
  - i. media
  - ii. protocol
  - iii. messages and information
- (d) Vehicle environment
- (e) Coupling and charging-station issues:
  - i. security and interlocks
  - ii. operation interface
- (f) Battery considerations

As the numbers of EVs steadily increases it becomes of paramount importance to derive standards that address the many issues that arise from connecting the vehicle to the electrical supply for charging. For example, a number of basic assumptions have had to be made regarding the EV plug and cord connection, these include:

- The coupling configuration for slow, normal, and fast charging will be common at the point of connection but have unique cord connection/handle design.
- For normal- and fast-rate charging the cord and plug will be stored off-board.
- For slow rate charging, an on-board adapter cord-set will be utilized.
- The coupling should assume no preferred location for the charger for slow, normal, or fast-rate charging.
- The safety and control mechanisms identified by the EPRI-IWC Connector and Charging Stations Subcommittee shall be utilized as fundamental considerations in the coupling design (GFCI, dead-front construction, no-load make-and-break, etc.).
- The cord for slow-rate charging will be standard high/low temperature outdoor rated for

hard service. The cord for normal rate charging will be standard high/low temperature outdoor rated for hard service with an additional exterior protective jacket for public charging. The cord for fast rate charging will be a special configuration capable of withstanding environmental extremes, physical abuse, and extra hard service conditions and may incorporate additional protective jacketing.

Similarly, the major functional requirements of the EV charging connector have also been condensed to include:

1. The connection of the EV for the purpose of recharging shall be accomplished in as few steps as possible and by using one hand (i.e. Connection: a) Remove plug from stored position. b) Insert plug into receptacle on vehicle. c) Initiate charge commence command. Disconnect: a) Terminate charge process. b) Remove plug from vehicle receptacle. c) Return plug to stored position.)
2. To ensure proper conductor connection, the coupling orientation must be either intuitively obvious or totally irrelevant.
3. The human efforts expended in joining the coupling components must be well within the physical capabilities of 100 percent of the driving public, including persons with limited or restricted capabilities as well as children and senior citizens.
4. The connection process must be free of potentially injurious conditions that could cause physical harm in any way to the user.
5. The coupling components shall have the highest level of perceived safety possible (i.e. contact points not visible to user, no sharp edges, etc.).
6. The plug shall be capable of withstanding severe physical abuse (i.e. dropped from 6 feet onto a hard surface, run over by vehicle, etc.).
7. The plug in the disconnected position shall be capable of being dropped into salt solution, slush, snow, or mud or immersed in water immediately prior to connection without causing nuisance ground fault tripping after connection at commencement of charging.
8. Once connected, the coupling interface must be positively sealed from moisture due to driving rain, direct water stream, etc..
9. It shall not be physically possible to disconnect the coupling while power is flowing. This may be a passive or active mechanical interlock system in the receptacle that is actuated prior to power flow (electro-mechanical, hydraulic, pneumatic, other) and deactivated when power flow is terminated. An indexing or sense mechanism to ensure that the plug is fully engaged prior to interlock should be incorporated into the coupling design.
10. The coupling point is to be a minimum of 24" above ground level and no higher than 36" above ground level.
11. The preferred point of coupling will be located in the front, right-hand quadrant of the vehicle.
12. The size and weight of the components shall be held to an absolute minimum using creative design and sophisticated materials as required.
13. Any and all other features that contribute to improved safety; higher performance; lower cost, weight, or size; greater customer acceptance; ease of manufacturing and assembly; etc.

## **2. Draft J-1654: High-voltage Primary Cable; and Draft J-1673: High-voltage Primary Automotive Wiring Assemblies**

Working in conjunction with the task force on High-voltage Charging Systems, the High-Voltage Operational Systems working group has progressed these two draft standards in response to their mission, which is "To develop standards for high-voltage wiring, terminals, connectors, and wiring harnesses used in electric vehicles." An outline of the developing contents of the two draft standards is as follows:

J-1654:



- General Requirements of EV Cable

- Dielectric test
- Spark test
- Insulation resistance
- Identification
- Battery electrolyte compatibility
- Battery coolant compatibility

## J-1673:

- General Section

- Definitions
- Insulated cable
- Color coding
- Connectors
- Conductor splicing
- Terminal and connector function
- Wire assembly construction
- Wire assembly installation and protection
- Wiring overload protection devices
- Battery cables
  - voltage drop
  - cable size
  - cable construction

### 3. SAE J-1634: Electric Vehicle Energy Consumption and Range Test Procedure; and SAE J-1666: Electric Vehicle Acceleration, Gradeability, and Deceleration Test Procedure.

Both of these recommended practices were developed under the guidance of the SAE Light Duty Measurements Standards Committee and are based on an update of the original SAE J-227a. SAE J-1634 defines a three day test procedure, in which the EV's energy consumption and range are determined using a vehicle dynamometer and combinations of Federal Urban Drive Schedule (FUDS) and Highway Fuel Economy Test (HWFET) duty cycles. The major test activities comprise:

Day 1 -Prepare and instrument test EV  
 -Charge battery to 100% SOC  
 -Measure capacity at C/3 rate  
 -Charge battery to 100% SOC  
 -Thermally soak EV 12-36 h while connected to charger

Day 2 -Position EV on dynamometer  
 -Drive 2 FUDS cycles  
 -Drive 2 HWFET cycles  
 -Charge battery to 100% SOC  
 -Thermally soak EV 12-36 h while connected to charger

Day 3 -Position EV on dynamometer  
 -Drive alternate FUDS and HWFET cycles until test termination criteria met  
 -Charge battery to 100% SOC  
 -Measure battery capacity at C/3 rate

SAE J-1666, in the manner previously detailed in the original SAE J-227a, defines a series of road and dynamometer tests that measure the following:

- Acceleration characteristics on a level road
- Gradeability limit
- Gradeability at speed
- Deceleration
- Coast-down characteristics

### 4. SAE Draft Hybrid Electric Vehicle Test Procedure

The development of hybrid electric vehicles, in which more than one power source is used to supplement the output of a battery powered electric drive train, necessitates the derivation of new test procedures to measure the energy consumption and emissions, if any, of these relatively complex versions of EVs. The SAE Light Duty Measurements Standards Committee is presently engaged in developing a draft standard that prescribes a five day test procedure that comprises the following basic steps:

- Day 1 -Prepare and instrument HEV.  
-Charge battery and thermally soak vehicle 12-36 h.
- Day 2 -Measure energy consumption as a pure electric vehicle over the FUDS and HWFET test cycles.
- Day 3 -Measure pure EV range over FUDS test cycle (until auxiliary engine starts).
- Day 4 -Measure pure EV range over HWFET cycle (until auxiliary engine starts).
- Day 5 -Initiate auxiliary engine HEV mode.  
-Measure fuel economy (electric, gasoline, etc.) and emissions in hybrid mode over alternate FUDS and HWFET cycles.

#### 5. SAE J-551: Electromagnetic Compatibility

At the request of the SAE EV Standards Forum, the SAE Electromagnetic Radiation Standards Committee recently updated the Electromagnetic Comparability (EMC) standard SAE J-551 to include a section that addresses the unique characteristics of EV propulsion systems.

#### 6. SAE Sponsored National Electrical Code Article

The wide-scale use of EVs will be crucially dependent upon the timely availability of an EV charging infrastructure encompassing residential garages through multi-vehicle commercial charging stations. In order to ensure the correct installation of charging equipment, EPRI, through its IWC, recognized the need in 1990 to instigate the development of an addition to the National Electrical Code (NEC) handbook to provide guidance for installation of EV charging equipment. As a consequence, EPRI and SAE jointly established an NEC EV article writing panel that has as its mission "To provide an article to the 1996 NEC that ensures the safe installation and use of EV charging equipment at home, work, and in commercial charging stations." This objective arises in response to the question: Why does the NEC

handbook need an EV charging article? The answer being:

- Automotive EVs are presently undefined in the NEC.
- EV charging in the home and at public facilities is not in the current code.
- EVs have unique requirements and issues.
- EVs may be one of the largest electrical loads in the home.
- NEC enforcement officials need accessible, reliable information.

Throughout its development in 1993 the EV charging article went through several stages involving numerous agencies:

1. Preliminary Draft: NEC officials, SAE, EEI, IEEE, UL, EPRI, and NEMA
2. Reviews: Manufacturers of electrical equipment, Automakers, Utilities, Government, Technical Experts, and Enforcement Officials
3. Substantiation: UL, Geomet, Penn State University, plus the agencies listed in 1 and 2 above.
4. Submission to NFPA on November 5, 1993 for assessment and subsequent incorporation into the 1996 NEC handbook

By way of providing a flavor of the article, the following is an outline of its content:

- General
  - Scope
  - Definitions
- Methods
  - Hard wiring
  - Connections
- Equipment Construction
  - Ampacity
  - Cord-Table 400-4
  - Means of coupling

• Control and Protection

- GFCI
- Disconnecting
- Grounding

• Locations

- Indoor site ventilation
- Outdoor site protection

**7. EV Battery Standards Committee**

This recently formed committee held its first meeting in August of this year, when it defined its mission as "To facilitate the introduction of EVs by setting and coordinating standards and recommended practices for the use of batteries in electric road vehicles. These standards will cover safety, cost effectiveness, reliability, testing, performance, and interfaces. Also coordinate these activities with other domestic and international standards organizations/agencies."

In recognizing the many areas of EV batteries that need standards generated, the committee endeavored to prioritize those it had identified within two general categories of Safety and Operational:

Safety

1. Hazardous emissions
2. Auto disconnect, earth protection, and shock
3. Abuse testing
4. Overcharging
5. Water submersion
6. Labelling

Operational

1. Electrical performance
  - power and energy
  - charge acceptance
  - life

Not yet prioritized:

- Venting and watering systems
- Thermal management

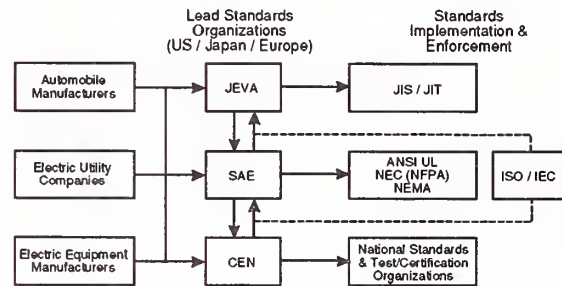

Figure 3. International EV standards process flow.

- EMC
- Mechanical performance (retention, shock, vibration)
- Charging
- Standard types/packages
- Interfacing (power and control, electrical, mechanical, and thermal)

The committee's immediate short term priority is to conclude a test procedure for measuring the rate of evolution of hydrogen from aqueous EV batteries during charging, in support of the NEC article.

**8. EPRI IWC Liaison.**

In the same manner that SAE has taken the lead on deriving standards for the vehicle aspects of EVs, EPRI has been the prime mover in addressing the electrical supply infrastructure issues resulting from the wide-scale deployment of EVs.

Under the auspices of EPRI's Infrastructure Working Council (IWC) five subcommittees have been established to facilitate the introduction of EVs as viable alternatives to the ubiquitous internal combustion engine vehicle, part of which is to support the derivation of appropriate standards, procedures, and regulations. The five subcommittees and their mission statements are as follows:

1. Connecting and Connections Stations: The Connecting and Connecting Stations mission is to define standardized physical and electrical configurations for the transfer of power and a physical configuration for the exchange of information at the utility-to-vehicle interface.

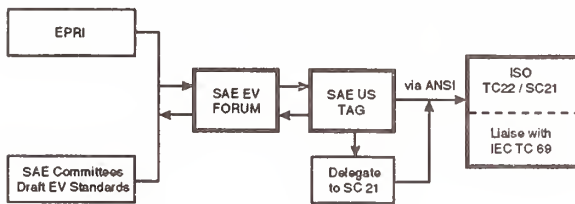

**Figure 4.** Development route for international EV standards.

2. **Health and Safety:** The mission of the Health and Safety Committee is to enhance the safety of people, their property, and the environment from the potential hazards that may be uniquely associated with operating and maintaining an electric vehicle through research, development of codes and standards, education, and technical advisory services.
3. **Load Management, Distribution, and Power Quality:** The mission of the Load Management, Distribution and Power Quality Committee is to identify and propose resolution of critical issues relating to the distribution and use of electricity for EV charging, and, to promote the research and application of EV charging Load Management, Distribution Planning and Power Quality mitigation tools.
4. **Utility Information and Customer Education:** The mission of the Utility Information and Customer Education Committee is to inform and educate target audiences (regulators, utilities, customers, manufacturers, etc.) about key electric vehicle issues.
5. **Data Interfaces:** The mission of the Data Interfaces Committee is to plan and define data interface(s) across all elements of the EV supply equipment.

Together, the SAE Standards Committees and the above EPRI IWC committees form the major part of the standards making "backbone" of the fledgling EV industry.

#### 9. SAE J-1715: EV Terminology Manual

Presently, this draft SAE document, which provides concise interpretations of the major, commonly used EV terms, from acceleration power

through vehicle test weight, is being reviewed by EV Forum members. It is anticipated that it will be issued in the first quarter of 1994.

### INTERNATIONAL STANDARDS ACTIVITIES

As regards the development of international standards for EVs, there are two agencies, worldwide, that coordinate activities and issue standards: the International Standards Organization (ISO) and the International Electrotechnical Commission (IEC). These two organizations have established technical standards subcommittees, TC22/SC21 and TC69 for the ISO and IEC respectively for EV activities. It is through these two subcommittees that national standards institutes (ANSI for USA, JEVA for Japan, and CEN for Europe) propose standards for adoption by the international community. This process is shown diagrammatically in Fig. 3. The suggested route for coordinating the U.S. national committees' submissions to ISO and IEC is outlined in Fig. 4, which illustrates the role of an SAE U.S. Technical Advisory Group (TAG), comprising national experts, in advising ANSI of U.S. industry views on proposed international standards offered by ISO/IEC for balloting. The many stages involved in the international standards balloting and development process is shown in Fig. 5.

As regards the current activities of the international standards organizations, an overall impression of this can be gained from the numerous working groups that are presently meeting:

#### ISO TC22/SC21

WG1: Vehicle safety and definitions

WG2: Road performance and energy consumption

#### IEC TC69

WG2: Motors and control systems

WG3: Batteries

WG4: Chargers

WG5: Hybrid Electric Vehicles

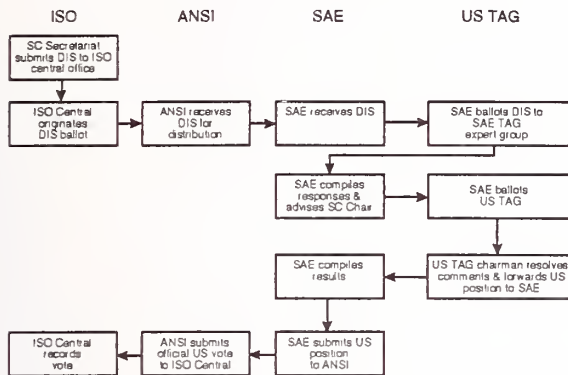

**Figure 5.** The stages of development of international standards.

## CONCLUSION

During the two years the SAE has been operating its EV Standards Forum, numerous draft standards have been progressed. However, SAE acknowledges that it has a formidable task to get in place, in a timely fashion, the standards needed for the emerging EV industry, but the incentive and the need to do so are clearly there.

### CEN TC301

WG1: Performance measuring methods

WG2: Safety (regenerative braking)

WG4: Vehicle-to-charger interface

WG5: Safety and other aspects

The Japanese Electric Vehicle Association (JEVA) is developing its national standards through four subcommittees:

#### Vehicle Subcommittee

- Test methods, electrical and acoustical noise, electric shock prevention, and vehicle wiring

#### Battery Subcommittee

- Battery dimensions, test methods, and maintenance

#### Infrastructure Subcommittee

- Charger specifications
- Safety standards

#### Eco-station Subcommittee

- A short-term task force to create a base of draft standards

10/10/2010

10/10/2010

10/10/2010

10/10/2010

10/10/2010

10/10/2010

10/10/2010

10/10/2010

10/10/2010

10/10/2010

10/10/2010

10/10/2010

10/10/2010

10/10/2010

10/10/2010

10/10/2010

10/10/2010

10/10/2010

10/10/2010

10/10/2010

10/10/2010

10/10/2010

# WORKING SESSION REPORTS





## SESSION REPORT: ENERGY CONVERSION SYSTEMS

R. W. Bartholomew

Senior Evaluator, Office of Technology Evaluation and Assessment  
National Institute of Standards and Technology  
Gaithersburg, MD 20899-0001

and

A. J. Sobey

Private Consultant  
Bloomfield Hills, MI 48304

### INTRODUCTION

The workshop session on "Energy Conversion Systems" was attended by over 40 people. These people brought with them a variety of work experiences, technical backgrounds, and interests. Among the attendees were people from the California Air Resource Board and the Environmental Protection Agency interested in emissions, General Electric's energy storage systems, Hughes and General Motors' electric vehicle group, Chrysler's propulsion systems, the Lawrence Livermore Laboratory's hydrogen-fueled spark ignition engines group, US Postal Service representatives interested in learning about fleet alternatives, developers for aluminum-air and zinc-air batteries, program managers for various prototype and demonstration projects in the area of fuel cells and engine designs, and several people working on small start-up companies for the manufacture of fuel cells, heat engines, hybrid and electric vehicles.

### OBJECTIVES

The objectives of the session were to identify the current state of technology and to then suggest possible development options for the more promising energy conversion systems. One method of accessing the promise of a particular technology was described in the chairman's introductory comments [1]. The method is based on experience gained in the Energy-related Inventions Program (ERIP), which is run jointly by the Department of Energy (DOE) and the National Institute of Standards and Technology. The ERIP, in determining the technical "promise" of a particular tech-

nology or product, considers the technical feasibility and the technical advantages of a proposed technology or product over existing technologies or products, the magnitude and significance of the energy impact, economic considerations, and commercial barriers. An additional consideration raised by the attendees that is applicable for assessing the promise of a new technology or product is the difference between evolutionary (e.g., incremental) and revolutionary (e.g., quantum) levels of improvements as well as the maturity of the area of technology.

### IDENTIFICATION OF ENERGY CONVERSION SYSTEMS

Discussions focusing on the first objective of the session, namely the identification of energy conversion systems suitable for either hybrid or electric vehicles, resulted in the following list (not necessarily in order of importance):

#### **Hydrogen-fueled, or hydrogen-enriched fuels for spark ignition engines**

Discussions during the workshop suggested this was a technology that should be receiving more attention as a transitional technology from gasoline-fueled engines to other types of energy conversion systems. The principal advantage of hydrogen fuel is in the area of emission reductions. The obstacles to the development of this technology include: lack of a distribution infrastructure, the need for storage technology, the current cost, and low flammability limits. An additional consideration was the issue that retrofits may not be easy

to perform. The development deemed most critical was the storage technology (as well as to several other energy conversion options). Two papers were presented on hydrogen-related technologies. The first was by J. Ray Smith [2] from Lawrence Livermore National Laboratory who presented a brief comparison of hydrogen-fueled spark ignition internal combustion engines and other hybrid technologies. The second paper was presented by Daniel Cohn [3] from MIT's Plasma Fusion Center who discussed the use of a plasmatron to reform a hydrocarbon based fuel into a hydrogen-rich fuel. The advantage of a plasmatron for hydrogen enrichment of the fuel was an anticipated factor of 10 reduction in emissions over a conventionally fueled internal combustion engine.

#### **Alternative fuels for the internal combustion engine**

The discussion of hydrogen fuels broadened eventually into a more general discussion of alternative fuels, including the use of hythane (a mixture of hydrogen and methane), compressed natural gas, and liquified natural gas. The desirability and the need for multi-fuel capabilities was discussed with concern expressed over the need and desirability for vehicles that can run on any fuel: a great cost is associated with this flexibility. Other alternate fuel based technologies were not discussed due to a lack of representation by members from the alternate fuels research community.

#### **The use of smaller engines running at near-optimal conditions to reduce exhaust emissions, and the use of high compression ratio, high thermal efficiency engines**

The principal design requirement to consider is the effort needed to get the internal combustion engine into a vehicle, i.e., cost, weight, and size. The consensus was that not enough attention has been paid to the development of small engine technology, especially in light of the existing infrastructure for current internal combustion engine technology. Marius Paul from Engine Corporation of America presented a paper [4] on high compression ratio diesel engines that could be used in low-emission vehicles. A discussion on the merits of 2-stroke versus 4-stroke engines was tabled for a

future meeting.

#### **The gas turbine engine as a possible alternative to conventional internal combustion engines**

Discussion was limited because expertise in this area was not in attendance. However, workshop participants recognized Volvo's [5] prototype vehicle using a gas turbine engine.

#### **Other internal combustion engine technologies for a hybrid vehicle**

Stirling, adiabatic, and steam engines were not discussed in this session.

#### **Fuel cell technology**

Proton exchange membrane (PEM) fuel cells, phosphoric acid fuel cells (PAFC), and solid oxide fuel cells (SOFC) were noted. Dr. Russ Kevala of H Power Corporation gave an overview of the Department of Energy's (DOE) PAFC bus program [6]. PEM technology for automobiles is still in the development stage, but appears promising. Ballard's fuel cell bus also was mentioned. SOFC technology is being promoted for long-term development. Two advantages of using fuel cells in a hybrid configuration are economic incentives and weight benefits. For example, the combination of fuel cells and nickel-cadmium batteries used in the PAFC bus weigh about 1/7 the battery weight for the same range (approximately 240 km or 150 miles) in a pure battery vehicle.

#### **Aluminum-air and zinc-air batteries**

While both of these systems are referred to as "batteries," aluminum-air batteries consume aluminum as a "fuel," and thus are more appropriately considered a fuel cell (or semi-cell). Theoretically, zinc-air batteries can be recharged, but a practical method has yet to be found. Thus, zinc-air can be considered a "battery." Representatives from the aluminum-air battery development groups felt that this technology was moving toward commercialization with a possible 400 km (250 mile) range for hybrid vehicles. (Aluminum-air batteries are currently used in a number of applications; one discussed in this

workshop was as back-up power in the telecommunication industry.) Several disadvantages to this technology were discussed, namely, the need for higher specific power and lower cost. The cost issues centered upon the life cycle costs of the aluminum-air battery's aluminum electrodes, which are consumed while the battery generates electrical power. Zinc-air batteries are currently cheaper than the aluminum-air batteries, but have a number of technical problems that need to be solved before they can be considered a viable candidate for electric or hybrid vehicles. To reform the spent aluminum back into electrodes, the aluminum needs to be refined. The turn-around efficiency of the zinc-air battery is slightly better than aluminum-air batteries. For the aluminum-air battery, the manufacture of the aluminum electrodes currently uses approximately 15 kW·h/kg of aluminum. This aluminum, in the form of electrodes, will generate approximately 4.3 kW·h/kg. It was hoped that by the year 2000, fuel refinement costs will drop if the battery's intolerance to impurities can be improved.

### PERFORMANCE SPECIFICATIONS

Performance specifications for electric and hybrid electric vehicles include traditional measures such as range (equivalent kilometers per gallon) and acceleration/deceleration rates. The former addresses the energy needs of the vehicle while the latter considers the power requirements and the regenerative braking system. Questions were raised as to what constituted an acceptable range for the vehicle. Comments were made about studies performed by the automobile manufactures that indicated that 240 km was the minimum acceptable range for the average potential buyer of these vehicles. However, a discussion followed as to whether this range was acceptable for fleet vehicles. It was also considered important that the performance of the electric or hybrid vehicle's energy conversion system mimic current internal combustion engine-based technology so that the type of energy conversion system in use is transparent to the driver.

A key issue in designing and assessing the promise of these technologies is the realization that the energy and power issues are different for the electric vehicle and the hybrid vehicle. In the electric vehicle, the power is available for tran-

sient performance, but range (energy storage) is the limiting factor. There is also a distinction in the types of hybrid vehicles. In a "series" hybrid, a secondary energy source (such as an engine or fuel cell) is utilized to replenish the energy of the primary energy conversion system (such as a battery), and thus increase the range of the vehicle. The primary energy conversion system should thus be capable of providing the entire power needs of the vehicle. The secondary energy conversion system can be a small engine running at constant speed for optimal emissions. It also could be a battery with a high energy density and low power capabilities.

In contrast to the series hybrid, the "parallel" hybrid has both of the energy conversion systems providing power to the vehicle, but only one of the systems is capable of fulfilling the high energy requirements. For example, in a vehicle using fuel cells and batteries, the batteries can augment the fuel cell's power for brief periods, such as during acceleration. The rest of the time, the fuel cells provide all of the power requirements for the vehicle, including the maintenance of the charge for the battery so that the battery is ready for the next required burst of power. The battery system is also designed to accept and store the regenerative energy during braking or deceleration. (This function of the battery, i.e., the storing of regenerative power, can theoretically be performed by a capacitor, but the current state-of-the-art capacitor cannot provide the sustained power surges needed for acceleration or long-duration hill-climbing.) Most of the discussions during this workshop session focused on parallel hybrid systems.

The discussion of performance specifications eventually broadened to include the entire energy conversion system (e.g., not just the hardware associated with the engine, but also the fuel costs, infrastructure costs, and full life cycle costs). The discussion showed that the issues used for defining performance and comparing different systems are difficult to define and evaluate when comparing dissimilar technologies. To do this comparison properly, one must first agree upon a common set of data for efficiencies, braking and simulation models, and correction factors for differences in levels of infrastructure (e.g., actual cost of using petroleum-based fuels on, for example, the environment versus "at-the-pump" prices). Fur-

ther, agreement is needed on what the boundaries should be for the overall life cycle: how far forward and how far backward should the history of the entire energy system be tracked? There was a strong consensus that this type of analysis is important for assessing the promise of various technologies since to a large degree energy resources will drive the selection of energy conversion systems. Given the number of competing technologies and the lack of accurate information concerning their advantages, disadvantages, and benefits, it is nearly impossible to assess technical promise and to identify possible "winners" without this type of analysis.

### CURRENT TECHNICAL, ECONOMIC AND COMMERCIAL BARRIERS

Technical barriers for the technologies discussed included:

1. System integration, optimization, and hardware experience were identified as obstacles in the near-term for the introduction of high-efficiency environmentally benign energy conversion technology. Progress being made on the energy conversion component has not been matched by the necessary supporting systems, i.e., air and fuel supply or thermal or water management for the PEM fuel cells. The target performance and cost of the energy conversion system for commercial introduction must be determined for an optimized system, which includes all of the components necessary for operation.
2. The response time for the reformer used with fuel cells could be a possible barrier to the fuel cell realizing acceptable performance. When the fuel cell stack operates on pure hydrogen, response time is considered to be acceptable. (Performance of the fuel cell stack is improved with the use of pure hydrogen compared to reformulated gas. The Ballard PEM fuel cell bus uses this technique to avoid the use of a battery for surge power.) An on-board steam reformer, such as the one used by the PAFC bus discussed by Dr. Kevala [6], adds complexity to the system, but provides a longer range as well as quicker refueling when using methanol. The slow response time of the

reformer is due to the thermal mass of the bed, which inhibits rapid changes in the rate of hydrogen production. Rapid-response reformers have been demonstrated in the laboratory, but they generally have much lower conversion efficiencies. Partial oxidation reformers being developed by ADL are expected to demonstrate rapid response and the use of ethanol to produce hydrogen. The response time problems associated with the reformer are thus not insurmountable, but are by no means completely resolved.

Two economic barriers were discussed:

1. The principal economic barrier was identified as the true cost of gasoline. Current gasoline prices are so low that there is very little economic incentive for the development of alternate fuels or energy conversion systems. For this reason, many people believed it was time for life cycle cost analyses to be performed for the technologies being considered for the hybrid vehicle, and for this information to be disseminated to the researchers and developers of these technologies as well as the policy makers.
2. The second economic barrier was the reluctance of the private sector to invest in these technologies until technical and business risks are better understood. Associated with the assessment of these risks is the total life cycle costs and benefits of these technologies.

Non-technical barriers, or more appropriately, commercial barriers for the development of an electric or hybrid vehicle are many. Particular issues are discussed in Albert Sobey's paper [7]. In summary, they are:

1. The existence of a gasoline-based energy infrastructure (fuel distribution and storage of fuel, trained service personnel, and operating history leading to estimable liabilities) means that there are many barriers where alternate technologies can break down. Rather than doing away with these barriers throughout the nation, it was felt that new infrastructures should be developed on a local or regional basis.

2. Government support (financial, leadership, and legislative) is required to reduce the level of risk incurred by the private sector as well as minimizing the unnecessary delay in the commercialization of these technologies. While it is true that government funds are flowing to the larger vehicle manufacturers, innovations are more likely to come from the smaller developers who generally cannot offer the government the same level of cost sharing.
3. Developing the infrastructure and supporting service requirements will be critical to the commercial success of the hybrid and electric vehicles. Suggestions were made that perhaps these infrastructures and supporting services should be developed through the incremental introduction of products and technologies. (Good aerodynamic practices for vehicle design and high-pressure tires are just two examples of technologies that could be used by both conventional and hybrid vehicles.) However, by first using these technologies on conventional vehicles, operating experience can be developed so that liability and service histories can be established for hybrid or electric vehicles, which are significant departures from current designs.
4. Coupled to the issue of how best to develop the new infrastructure while making the best use of existing infrastructures is a need to understand what our goals should be for the introduction of the hybrid and electric vehicles. The attendees felt that there is a need to distinguish between a goal based upon the reduction of vehicular emissions (primarily a state or regional need) and a goal of improved energy utilization and efficiency (more of a national need). Furthermore, the issue of whether policy should be driven primarily by health considerations or by the depletion of natural resources was also discussed.

#### **POTENTIAL TECHNICAL SOLUTIONS AND OPPORTUNITIES FOR DEVELOPMENT**

Key to the commercialization of the aluminum-air battery is the reduction of the life cycle cost

of the fuel (i.e., reducing the refining costs) and increasing the battery's tolerance to impurities, which also decreases the refining costs. For the zinc-air battery, recharging technology should be studied further to see if theory can be reduced to practice.

There was some discussion on obstacles to getting PEM fuel cells into vehicles. Some of the people in attendance felt that the humidification system for the electrodes was an area that needed further research. However, discussions after the session suggested that this issue has essentially been solved for laboratory-scale prototypes. Manufacturing cost reduction was considered to be the next hurdle for the PEM and PAFC fuel cells.

Greater fuel flexibility and the reduction in susceptibility to hydrocarbon poisoning of the fuel cell were also considered to be important areas of possible research.

In the area of alternate fuels, the need for improvements in hydrogen and compressed natural gas storage was seen as an opportunity for development work.

#### **SCHEDULE/TIMETABLE FOR EV AND HEV COMPONENT DEVELOPMENT**

Hydrogen-fueled internal combustion engines were discussed as a possible transitional technology to move the automotive industry from hydrocarbon fuels to alternate fuels or technologies. However, in light of some of the issues still facing this technology (particularly hydrogen storage and generation), many attending the session felt that compressed natural gas held good promise as a transitional technology.

In the area of fuel cells, the demonstration project for transit bus applications discussed by Russ Kevala [6], H Power Systems, is scheduled for operation beginning the first of the 1994, with two additional buses following in succeeding months. The buses use a phosphoric acid fuel cell (PAFC) for the energy conversion system. In Canada, Ballard is expected to demonstrate a full-sized transit bus with PEM fuel cells in late 1995. The attendees felt that SOFC technology would require long-term development.

## REQUIREMENTS FOR FUTURE STANDARDS/TEST PROCEDURES

One standards issue discussed in our session was raised by Professor Craig Marks in an invited presentation during the morning session [8]. In his example, Professor Marks told how a vehicle that had been running up to expectations throughout the test program in various parts of the country suddenly ran into drivability problems in the Denver area. The problem was eventually traced to the fact that the natural gas in the Denver area had a high fraction of hydrogen. Thus, in order to get the fuel into heating value specifications, a significant percentage of carbon dioxide was being added. While this natural gas mixture was adequate for home heating requirements, it led to significant problems in the automobile engine's performance and drivability. This is one example of the standards in the area of alternate fuels that are needed before the hybrid vehicle is introduced into the market place.

## CLOSING REMARKS

A common theme that recurred during these discussions was the need for better dissemination of technical, economic, and commercial information. This need was manifested in two ways. Firstly, there was a general lack of agreement of critical data needed to compare different technologies. This paucity of accurate data led to rather gross assumptions in making comparisons and brought into question the validity of these comparisons. Secondly, the information being used by different groups was not up-to-date. For example, some people felt humidification of the electrodes in PEM fuel cells was a critical problem while others felt that satisfactory solutions for this problem were on their way out of the laboratory. In addition to being up-to-date, information must be accurate, timely, and reliable. The need for a better method of disseminating technical information was clearly indicated.

Finally, the enthusiasm and variety of expertise brought to this session by the people who presented papers is recognized. Their contribution led to interesting, informative, and lively discussions. Special thanks are extended to Mr. Albert Sobey, a private consultant; Dr. Russ Kevala from H Power

Corporation and Dr. William Ernst from Mechanical Technology, Inc. for reviewing this summary for accuracy and completeness.

## REFERENCES

- [1] R. W. Bartholomew, "Opening Remarks for the Parallel Session on Energy Conversion Systems," these proceedings pp. 71-75.
- [2] J. R. Smith, "The Hydrogen Hybrid Option," these proceedings pp. 76-82.
- [3] A. Rabinovich, D. R. Cohn, and L. Bromberg, "On-board Plasmatron Generation of Hydrogen-rich Gas for Engine Pollution Reduction," these proceedings pp. 83-88.
- [4] M. Paul "Advanced Engine and Fuel Systems," these proceedings pp. 89-97.
- [5] Certain commercial equipment, instruments, or materials are identified in this paper. Such identification does not imply recommendation or endorsement by the National Institute of Standards and Technology, nor does it imply that the materials or equipment identified are necessarily the best available for the purpose.
- [6] R. J. Kevala, "Phosphoric-acid Fuel-cell Bus Development," these proceedings pp. 97-101.
- [7] A. J. Sobey, "Non-technical Barriers to Product Commercialization," these proceedings pp. 106-115.
- [8] C. Marks, "Electric and Hybrid Electric Automobiles Imperatives for Commercial Success," these proceedings pp. 33-39.

## OPENING REMARKS FOR THE PARALLEL SESSION ON ENERGY CONVERSION SYSTEMS

R. W. Bartholomew  
Senior Evaluator, Office of Technology Evaluation and Assessment  
National Institute of Standards and Technology  
Gaithersburg, MD 20899-0001

### ABSTRACT

This paper defines some of the issues to be addressed in the parallel workshop session "Energy Conversion Systems." Issues presented included suggested evaluation criteria for ranking the technical alternatives and an example of the types of engineering paradoxes that need to be evaluated.

### INTRODUCTION

There are several issues that we would like to address in this session. These issues relate to the identification of critical components for hybrid electric vehicles for the year 2000 and beyond and the basic research and development needed for these components. After identifying these critical components, we will then review their performance requirements, to identify those components that are considered to be more or less promising, to discuss what needs to be done to overcome any existing or anticipated technical, economic or commercial barriers, and finally, to identify where opportunities for innovation lie.

This session focuses on energy conversion systems. These include: conventional internal combustion engines, such as Stirling engines, turbine engines, or adiabatic engines; fuel cells; alternate fuels; and hydraulic motors. The session also addresses how energy storage systems, such as batteries, flywheels, ultracapacitors, hydraulic accumulators, and elastomers impact energy conversions systems and change the operating characteristics and performance considerations of the energy conversion system.

### A SUGGESTED EVALUATION CRITERIA

In evaluating these energy conversion systems, we need to establish a measure of their commercial

"promise." There are a variety of ways to measure commercial promise: As an opening suggestion, I would recommend criteria developed by the Energy-Related Inventions Program (ERIP). The ERIP was established in 1975 and is run jointly by the Department of Energy (DOE) and the National Institute of Standards and Technology (NIST). NIST's Office of Technology Evaluation and Assessment (OTEA) evaluates inventions and technology submitted to the ERIP to determine if an invention is sufficiently promising to warrant government support for its development. (Inventions identified as having promise are referred to the DOE who may provide grants or other support for commercialization.) Many of these inventions represent technologies and products that are in very early stages of engineering development. For the present discussion, "early stage of development" will be taken to refer to a product or technology that needs to be defined conceptually, to have its technical feasibility established, to have a working prototype constructed, or to have the pre-production design finalized. By this definition, many of the technologies we will discuss in this session would be considered "early-stage-of-development" technologies.

The evaluation process that OTEA applies to inventions submitted to the ERIP has been refined over nearly two decades. The evaluation process has been distilled to the point that the "promise" of an invention can be determined by consideration of five criteria:

1. The technical feasibility of the invention.
2. The distinct advantages that the invention has over competing products.
3. The benefit to energy production or energy usage at the national level that the invention will produce.
4. The costs associated with development, manufacture, and use of the invention.
5. Barriers that hinder commercialization of the invention; such as industrial, consumer, or national bias against the use of a particular product; safety and standards requirements; or liability, legal, or infrastructure issues. These barriers must be identified and there must be a reasonable expectation that they will be successfully addressed or overcome.

One should note that these criteria can be applied objectively, and thus are appropriate for the evaluation of products that are driven by technological considerations. Issues that pertain to products whose commercialization is driven by consumer preference are not necessarily addressed, and the evaluation of a consumer preference product would require additional criteria. However, the products discussed in this workshop would be considered as "technologically driven" and thus should be adequately evaluated by these five criteria.

The degree to which these evaluation criteria can successfully identify promising, early-stage-of-development products, is periodically assessed by ERIP program reviews. The most recent review, completed in 1990 [1], identified the evaluation process performance indicators listed in Table 1.

A second review, completed in 1993 [2], looked at inventions reviewed by OTEA for ERIP that did not meet one of the five criteria (typically insufficient energy impact). These products were found to have significantly fewer commercial sales and did not last in the market place as long as the technologies identified by OTEA as "promising."

One can conclude that the evaluation criteria listed above can be used to successfully identify promising, early-stage-of-development technologies, and thus are a reasonable starting point

for accessing the "promise" of the technologies considered here.

### SOME ENERGY CONVERSION SYSTEM REQUIREMENTS

With discussion points for the determination of a product's "promise," we now turn to opening remarks on energy conversion system requirements. For transportation applications, the primary performance criterion for the energy conversion system has been to match the power, torque, and speed requirements of the vehicle to the power, torque, and speed of an energy conversion system, such as an internal combustion engine. To achieve this match, one would ideally operate the engine at its highest efficiency (its peak power or its peak torque) and have a continuously variable transmission that matches the engine's output to the vehicle requirements. However, this is not the solution that has evolved historically. Instead, the engine has proven to be easier to control and thus the engine output has been continuously varied to match vehicle requirements through a transmission with only a few finite steps. As a consequence, the engine is usually operating at conditions that differ significantly from its optimal operating conditions.

While decreased fuel and thermal efficiencies and increased exhaust emissions, which are consequences of operating the engine at less than optimal conditions, have historically been tolerated, the more recent attention to global warming and air quality have made the reduction of exhaust emissions an increasingly important engine design consideration. The engine designer, who has historically been faced with economic considerations, vehicle drivability, operating behavior, and packaging, now must also consider exhaust emissions.

Designing an energy conversion system that can either augment or replace the internal combustion engine and satisfies the above requirements, is the challenge now facing automotive engineers. To illustrate the level of compromise needed to achieve a reasonably successful design alternative, let us consider one of the design requirements: vehicle acceleration.



**Table 1.** Summary of ERIP performance indicators for the years 1975–1990.

Number of inventions evaluated	Over 25,000
Number of inventions deemed "promising"	486
Number of inventions receiving grants	Over 80% of "promising" inventions
Total grants (millions of dollars)	\$25.7
Number of inventions commercialized	At least 109
Number of "spin-off" technologies	At least 23
Total commercial sales (millions of dollars)	Over \$500 (from 100 + 23 inventions)
New jobs created	Over 750

### POWER REQUIREMENTS FOR VEHICLE ACCELERATION

Under steady cruising conditions, the brake horsepower (bhp) developed by the engine balances the driving resistance and accessory loads of the vehicle. That is,

$$P_{\text{engine}} = (P_{\text{roll}} + P_{\text{aero}} + P_{\text{climb}}) + P_{\text{accessory}} \quad (1)$$

where  $P_{\text{engine}}$  is the brake horsepower of the engine,  $P_{\text{roll}}$  is the rolling resistance of the vehicle,  $P_{\text{aero}}$  is the aerodynamic drag of the vehicle,  $P_{\text{climb}}$  is the climbing resistance, and  $P_{\text{accessory}}$  is the power consumed by the accessories (heating, ventilation, and air conditioning; radio; lights; etc.) Collectively, the first three terms on the right hand side of eq(1) are referred to as the tractive resistance,  $P_{\text{tractive}}$ .

The acceleration of the vehicle,  $a$ , is related to the power developed by the engine in excess of the tractive and accessory power requirements,

$$a = \frac{\eta_{\text{trans}} \cdot P_{\text{engine}} - (P_{\text{tractive}} + P_{\text{accessory}})}{v \cdot k_m \cdot m} \quad (2)$$

where  $\eta_{\text{trans}}$  is the efficiency with which the torque of the engine is transmitted to the driving wheels,  $v$  is the velocity of the vehicle,  $k_m$  is the rotational inertia coefficient (i.e., a measure of the apparent increase in mass of the vehicle due to the rotation of the flywheel, crankshaft, wheels, etc.), and  $m$  is the mass of the vehicle.

From eq(2) it is evident that there are only a limited number of ways to increase the acceleration of the vehicle. One of the most obvious methods is to decrease the terms in the denominator, i.e., either the mass of the vehicle,  $m$ , or the rotational inertia of the vehicle. To the degree that

the mass of the vehicle is affected by the mass of the energy conversion system, we can see that decreasing the mass of the energy conversion system would improve acceleration.

The rotational inertia coefficient,  $k_m$ , in eq(2) has typical values that range from 1.0 to approximately 1.4 and depend upon the mass of the vehicle, transmission gear ratio, tire diameter, and, in the case of the internal combustion engine, engine displacement [3]. Decreasing the transmission ratio or engine displacement, or increasing the mass of the vehicle or tire diameter, will decrease the value of  $k_m$ . Thus, smaller engine displacements lead to smaller values of  $k_m$ , and therefore greater rates of accelerations. (That is one of the reasons why high-performance fighter aircraft engines of World War II had many small cylinders rather than a few large cylinders.)

For internal combustion engines,  $\eta_{\text{trans}}$  ranges between 0.88 and 0.92 for longitudinally mounted engines [4] to 0.91–0.95 for transversely mounted engines. It is therefore advantageous to use a transversely mounted engine. This desirability of the transversely mounted engine dictates to some degree the size and configuration of the engine.

The power consumed by accessories depends on operating conditions as well as engine speed. Table 2 summarizes the power requirements of a typical 1977 model year V-8 engine [5, 6]. Actual power requirements depend upon operating conditions (i.e., day or night, winter or summer, engine speed, vehicle size, etc.). Values for the operating parameters listed in Table 2 thus should be interpreted as approximate. The total power requirements of the accessories range from a low of approximately 2 kW (3.6 bhp) to more than 11 kW (17 bhp).

**Table 2.** Summary of power requirements of various accessories used in vehicles

Accessory	Power Requirements	
	(kW)	(bhp)
Air conditioning compressor	1.5-6	2-8
Alternator	0.6-1.5	0.8-2
Electrical (head light, fog lights, windshield wipers, etc.)	0.3-0.7	0.4-1
Power steering	0.2-1.5	0.3-2
Radiator fan	0.1-3	0.1-4
Radio	0.01-0.05	0.01-0.07

The final set of terms effecting acceleration are the three tractive power requirements: i.e., the rolling resistance, aerodynamic drag, and climbing resistance. Rolling resistance is associated with the work required to deform the tire and the road surface as the vehicle moves. The power required to overcome this rolling resistance,  $P_{roll}$ , is

$$P_{roll} = f \cdot m \cdot g \cdot v \quad (3)$$

where  $f$  is the coefficient of rolling resistance,  $m$  is the mass of the vehicle, and  $g$  is gravitational acceleration.

Representative values for the coefficient of rolling resistance can be found in Table 3. The rolling resistance depends upon the material of construction for the tire as well as the road surface and other parameters [7]. The power required to overcome the rolling resistance of the vehicle can thus be decreased by reducing the weight of the vehicle, reducing the friction in the wheel bearings, using better lubricants, or reducing tire deformation work. In terms of options associated with design of the energy conversion system, decreasing the mass of the conversion system would tend to reduce the rolling resistance.

The second contribution to the tractive power requirement is the power to overcome aerodynamic drag

$$P_{aero} = \frac{1}{2} C_D \cdot \rho \cdot A \cdot v \cdot (v - v_0)^2 \quad (4)$$

where  $C_D$  is the drag coefficient of the car,  $\rho$  is the air density,  $A$  is the frontal area of the vehicle,

**Table 3.** Sample values for the coefficient of rolling resistance

Wheel/road Surface	Rolling Resistance Coefficient, $f$
steel wheels on rails	0.001
pneumatic tires on concrete asphalt	0.015
pneumatic tires on farmland	0.35

**Table 4.** Aerodynamic drag coefficient of selected vehicles

Body Style	Drag Coefficient, $C_D$
optimally streamlined	0.15
sedan body	0.33
streamlined bus body	0.4
van body	0.55
trucks	0.8-1.5

and  $v_0$  is the velocity of the head wind. Values for the drag coefficient depend upon body styling; several representative styles are listed in Table 4 [8]. The only energy conversion system design parameter effecting the drag coefficient is the size of the conversion system. For aerodynamic styling, the energy conversion system should be low and compact.

The third and final contribution to the tractive power requirement is the climbing resistance power,  $P_{climb}$ , given by

$$P_{climb} = m \cdot g \cdot v \cdot \sin(\theta) \quad (5)$$

where  $\theta$  is the angle of inclination and is positive when going uphill. As was the case for the rolling resistance, the effect of engine design would manifest itself on the climbing resistance through the weight of the vehicle. Thus, a lighter energy conversion system would reduce the climbing resistance.

The only term that has not been discussed up to this point is the power generated by the energy conversion system itself. From eq(2) it is clear that the more power the energy conversion system can generate, the greater the acceleration. Typi-

cally, for an energy conversion system to produce more power, it must be larger and heavier. Thus a design trade-off is created. Increased acceleration can be obtained by making the energy conversion system more powerful (and thus larger and more massive) or smaller and lighter. But these are conflicting requirements, resolution of this conflict and the introduction of design compromises are left to the skill of the design engineers.

### CLOSING REMARK

Acceleration is but one example of the technical and performance issues discussed in this session. The design of an energy conversion system that is smaller and lighter than today's internal combustion engines and yet develops comparable power would have a technical advantage that could make it "promising." Determining the degree of promise would require looking into addition technical, economic, and commercial issues. These are issues that will be identified and discussed in this session.

### REFERENCES

- [1] M. A. Brown, C. R. Wilson, and C. A. Franchuk, "The Energy-Related Inventions Program: A Decade of Commercial Progress," Oak Ridge National Laboratory Report, ORNL/CON-339, Dec., 1991.
- [2] M. A. Brown, T. R. Curlee, S. R. Elliot, and C. A. Franchuk, "A Comparison Group Analysis of DOE's Energy-Related Inventions Program," Oak Ridge National Laboratory Report, ORNL/CON-365, June, 1993.
- [3] R. Bosch, *Automotive Handbook*, 2nd Edition, 1986, p. 260.
- [4] *ibid.*
- [5] *op. cit.*, R. Bosch, p. 422.
- [6] D. S. Shupe, "Update: Automotive Fuel Economy," *Mechanical Eng.*, Dec. 1977, 31.
- [7] *op. cit.*, R. Bosch, p. 256.
- [8] *op. cit.*, R. Bosch, p. 258.

## THE HYDROGEN HYBRID OPTION

J. R. Smith  
Lawrence Livermore National Laboratory  
Livermore, CA 94551

### ABSTRACT

The energy efficiency of various piston engine options for series hybrid automobiles are compared with conventional, battery powered electric, and proton exchange membrane (PEM) fuel cell hybrid automobiles. Gasoline, compressed natural gas (CNG), and hydrogen are considered for these hybrids. The engine and fuel comparisons are done on a basis of equal vehicle weight, drag, and rolling resistance. The relative emissions of these various fueled vehicle options are also presented. It is concluded that a highly optimized, hydrogen fueled, piston engine, series electric hybrid automobile will have efficiency comparable to a similar fuel cell hybrid automobile and will have fewer total emissions than the battery powered vehicle, even without a catalyst.

### INTRODUCTION

Today's conventional automobile that meets the Corporate Average Fuel Efficiency (CAFE) standards of 27.5 mpg uses fuel energy at the rate of 0.8 kW·h per kilometer traveled (1.28 kW·h/mile). The vehicle energy efficiency (defined here as the ratio of energy delivered to the wheels to the fuel energy used) is approximately 25 percent for this conventional vehicle on the highway. The highly refined gasoline piston engines used in current automobiles with compression ratios of about ten have maximum brake thermal efficiencies in the range of 30 percent. By appropriate selection of gear ratios, it is possible for the automotive designer to operate the engine near this maximum efficiency when at highway speeds. However, the urban driving cycle, with its varying speed and load demands, forces the engine to operate well away from the maximum efficiency point, resulting in a vehicle efficiency that is about one half of the peak efficiency. It has long been realized that hybrid vehicle designs that allow the piston engine to operate at its maximum efficiency could make significant improvements in fuel economy and emissions. How this might be accomplished and the projected results are the subject of this paper.

### VEHICLE ENERGY EFFICIENCIES

The fair comparison of different types of power train systems is a difficult task. Many assumptions must be made to make the problem tractable. Here, for consistency, we use the component efficiencies published in the Department of Energy Hydrogen Program Plan [1] (see Table 1). Although many of these values are arguable, the significance of the present work is in the trends—not the absolute values projected. Ultimately, the actual fuel efficiency and emissions that the automotive designer can demonstrate in a manufacturable, marketable, and profitable automobile will determine the market penetration and the corresponding automotive fleet changes. The energy efficiency of automobiles will continue to improve through weight reductions, better aerodynamics, and low-loss tires; but these technologies are available to all power train system options. Thus, for the comparisons made here, it is assumed that all vehicles have the same weight, aerodynamic drag, and rolling resistance. Implicit in the comparison is similar performance in terms of acceleration, range, and hill-climbing ability. The automotive consumer of today is sophisticated and demanding and is unlikely to purchase an automobile

**Table 1.** Vehicle comparison technology assumptions (abridged from Ref [1])

Technology	Current (1990)		Advanced (2020)	
	Efficiency (%)	Cap. Cost (\$/kW)	Efficiency (%)	Cap. Cost (\$/kW)
Central Base Fossil Plant	36	1,500	42	1,200
Electricity Transmission (500 miles)	92	300	95	300
Electric Motor Drive	90	100	95	100
Electrolysis	65	1,000	75	250
Fuel Cell	40	2,500	50	300
Battery Storage (5 hours)	70	120	80	80
I.C. Engine (Fed. Urban Driving Cycle)	15	50	19	40
Vehicle Power Train	85	10	90	10
Steam Reforming of Natural Gas	68	-	-	-

that does not compare reasonably well with conventional automobiles. Thus without these performance attributes the market penetration of hybrids will be severely limited. Five conceptual power train system designs are compared to the conventional gasoline piston engine automobile, which is examined in both the highway and the urban driving modes. The conventional vehicle is examined first. The energy efficiencies of the described hybrids, the battery powered electric vehicle, and the conventional vehicle are compared in Fig. 1.

### Conventional Automobile

The typical modern Otto cycle engine achieves a fuel efficiency of about 30 percent. The chief limitation to improved engine fuel efficiency in the spark ignition engine is the inability of the engine designer to raise the compression ratio due to "knock." Otto cycle engine efficiency is proportional to the compression ratio,  $R_c$ :

$$\eta = 1 - \{1/(R_c)^{\gamma-1}\} \quad (1)$$

where  $\gamma$  is the ratio of specific heats of the gases in the combustion chamber [2]. Knock, or autoignition of the unburned gases in the combustion chamber, occurs when the combined effects of temperature, charge density, and compression duration exceed the fuel's ability to resist a chain-branching chemical reaction, resulting in rapid energy release ahead of the flame front. This results in shock waves scrubbing away the protective boundary layers in the combustion chamber,

which enhances heat transfer rates enormously and ultimately results in engine damage. Using currently available unleaded fuels with octane ratings in the low nineties limits compression ratios to about ten. Clever combustion chamber designs that enhance heat transfer from the unburned end gases can allow slight increases in the compression ratio. There is also the possibility that an environmentally acceptable additive may yet be found that will delay the chain-branching reactions and thus effectively raise the octane rating of gasoline, which will in turn allow compression ratios to rise along with engine efficiency.

The drive train couples the output of the engine to the wheels at an efficiency of about 85 percent. Thus with ideal gearing and a small engine running near wide-open throttle, the engine runs at its "sweet spot," and the conventional automobile on the highway achieves about 25 percent energy efficiency.

In urban use the engine is required to operate at low speed or idle (17.7 percent of the EPA Urban Driving Schedule is idle time), which means that the throttle is partially closed. This results in most of the output of the engine being used to "pump" air from the atmosphere across the pressure drop of the throttle plate. This loss mechanism is referred to as pumping losses. (This loss does not occur in diesel engines because the load is matched by reducing the quantity of injected fuel, but diesels are not considered here because of their inherent emissions problems.) The spark ignition engine efficiency on the Federal Urban Driving Cycle is given in Ref. 1 as 15 percent. When com-

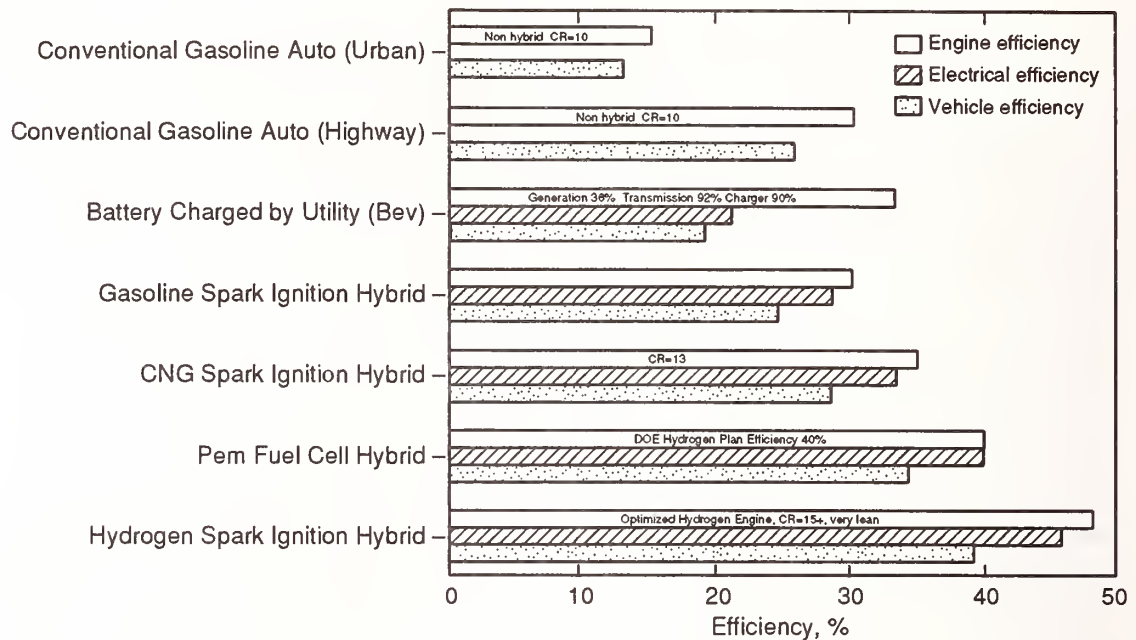

Figure 1. Energy efficiency estimates for conventional automobiles, battery powered electric, and hybrid vehicles. All vehicles have the same weight and drag, no credit taken for regenerative braking.

bined with the drive train efficiency, this yields a **Gasoline Hybrid** vehicle energy efficiency of about 13 percent.

### Battery Powered Electric Vehicle

The battery powered electric vehicle is assumed to be charged by a utility power plant operating at 36 percent efficiency with an electrical transmission efficiency of 92 percent [1]. Battery charger efficiency is assumed to be about 90 percent. Thus the energy is delivered to the vehicle with 30 percent efficiency. Current secondary batteries have an electrical "turn-around efficiency" (ratio of energy output to energy input) of about 70 percent [1]. The electric motor used to drive the wheels has a net efficiency of about 90 percent. Thus the battery powered electric vehicle has an overall energy efficiency of about 19 percent. This is significantly better than the conventional automobile in the urban cycle but not as good as the conventional auto in the highway cycle. The impact of this efficiency on emissions will be discussed.

The hybrid power train systems that we consider here are all similar except for the fuel and the engine that recharges the energy storage system. The basic concept is to use electric motors to drive the wheels, which are powered by an electrical energy storage system which is in turn recharged from a small piston engine/generator or fuel cell. The piston engine is run only when recharge is necessary and only at a single load and single speed that corresponds to its maximum efficiency operation point. This engine does not idle, and it runs at wide-open throttle to avoid any pumping losses. The gasoline spark ignition hybrid engine drives a lightweight aircraft generator (0.6 to 0.8 kg/kW) that recharges the electrical energy system. It is similar in performance to the conventional ten-to-one compression ratio engines in today's automobiles but has significantly smaller displacement because it is used primarily for recharging. Near stoichiometric operation is assumed so that three-way catalysts may be used. The engine would be sized for long-duration hill climb capability (20 to 40 kW), whereas the energy storage system is

sized for the more demanding acceleration phase (about 100 kW with 1 to 3 kW·h storage). The specific energy storage system chosen is the fly-wheel electromechanical battery (EMB) of Post et al. [3]. Although other electrical storage systems are possible, the EMB is particularly attractive because its low weight of 10 to 20 kg/kW·h, small volume of 30 to 50 liters/kW·h, and its high turn-around efficiency of greater than 95 percent. These weight and volume estimates for the EMB include containment cases and gimbaling necessary for automotive applications. Combining the engine, generator, and EMB efficiencies gives the electrical efficiency of 27 percent. Again, this electrical power must pass through the electric drive motor at 90 percent, resulting in a gasoline hybrid energy efficiency of about 24 percent. Note that this is slightly less efficient than the ideal conventional vehicle on the highway because of the additional components. However, such small differences should not be regarded as significant because of the many assumptions required to get to these estimates.

If the engine only recharged the EMB, this hybrid concept would be referred to as a series hybrid. However, it now appears possible to build controllers that would allow the electric drive motor to simultaneously receive power from both the engine generator and the EMB [4]. Thus effectively this becomes an electrically paralleled hybrid. The consequences of this controller advance are that the energy storage requirements and system costs may be somewhat decreased.

### CNG Hybrid

The compressed natural gas (CNG) hybrid is conceived of as identical to the above hybrid except for the engine and fuel storage. The effective octane rating for natural gas is 120 [5], which allows the compression ratio to be raised to about thirteen. We have used an estimated engine efficiency of 35 percent for the CNG fueled hybrid. Here too, near stoichiometric operation is assumed in order to use a three-way catalyst to reduce emissions. The other components are the same as for the gasoline hybrid, which results in a vehicle energy efficiency of about 28 percent. Note that this is 16 percent greater than the gasoline hybrid.

### PEM Fuel Cell Hybrid

The concept for the proton exchange membrane (PEM) fuel cell hybrid is identical to the hybrids described above except that the engine/generator is replaced with the fuel cell and the hydrogen storage system. The hydrogen storage problem is made more tractable by the use of the hybrid concept. Without the significant efficiency improvements of hybrids over conventional automobiles, hydrogen storage issues tend to dominate any automobile design. The choice of hydrogen storage technology is not yet clear [6]. Progress is being made in hydrogen storage in adsorbent materials such as carbon, but storage tank volumes are still quite large. Storage in hydrides has also made significant progress to the point where the volume is probably acceptable but the weight of the system is problematic. Bayerische Motoren Werke (BMW) has recently demonstrated a 32 gallon liquid hydrogen storage tank (in one of their 7 Series sedans) that has acceptable boil-off rates [7]. However, the energy penalty for hydrogen liquefaction is currently 32 percent for large plants [8].

To keep the power requirement from the fuel cell as small as possible, an EMB is included in the fuel cell hybrid. The energy efficiency of the PEM fuel cell is cited as 40 percent in the near term in Ref. 1, with the efficiency going to 50 percent by the year 2010. Using the near term value results in a PEM fuel cell hybrid vehicle energy efficiency of about 34 percent. The high efficiency of the fuel cell hybrid is attractive, but the total lack of emissions (if the hydrogen is made from renewable energy sources) is probably its greatest attribute. However, the current cost of PEM fuel cells is in thousands of dollars per kilowatt with projections of future cost in the range of \$300 per kilowatt. The fuel cell is the "right technical choice" but may be kept out of widespread use unless major breakthroughs in cost reduction can be accomplished.

### Hydrogen Hybrid

The hydrogen fueled spark ignition hybrid is very similar to the CNG hybrid described above. Fueling a piston engine with hydrogen allows leaner operation than with any other fuel. Under very lean operation, hydrogen has little propensity to

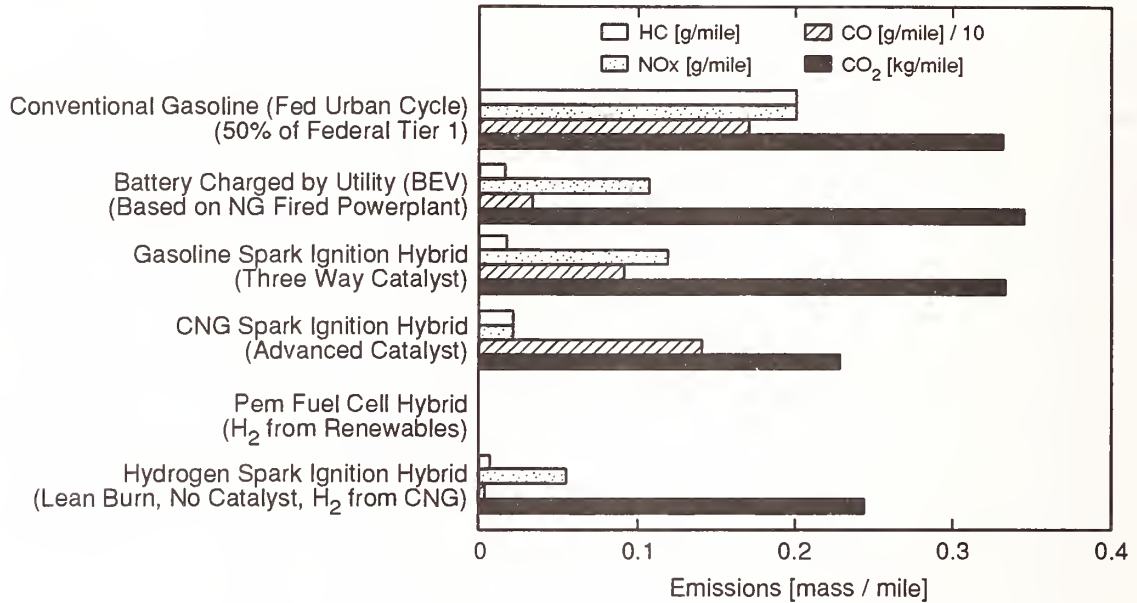

Figure 2. Emissions estimates for conventional automobiles, battery powered electric, and hybrid vehicles. Equal weight and drag, based on 27.5 mpg conventional automobile.

knock [9]. Therefore the effective octane number for lean mixtures is very high. (Great care must be taken in the review of hydrogen engine research that preignition from hot spots in the combustion chamber is not misinterpreted as a sign of low effective octane.) Thus the compression ratio can be raised to fifteen or more. In addition, the ratio of specific heats increases from about 1.3 for gasoline and CNG to nearly 1.4, which also increases efficiency as can be seen in Eq. 1. Hydrogen fueled piston engines have demonstrated indicated engine efficiencies of up to 54 percent at 15.4  $R_c$  [10]. (Correcting the indicated engine efficiency to account for mechanical friction would reduce the brake thermal efficiency to about 50 percent.) Using hydrogen, researchers have also achieved 45 percent engine efficiency at eleven  $R_c$  [11]. We assume here that an optimized hydrogen engine can be developed with an efficiency of 48 percent. Combining this engine with the other component efficiencies used above results in a hydrogen hybrid vehicle efficiency of about 39 percent. This is slightly better than would be expected from a PEM fuel cell hybrid. The cost of an optimized hydrogen fueled piston engine/generator will probably be in the range of \$50 to \$100 per kilowatt.

## VEHICLE EMISSIONS

Emissions have been estimated for each of the vehicle options by using the relative energy efficiencies projected above in combination with the demonstrated emissions characteristics of each type of engine. The PEM fuel cell hybrid, as stated above, does not have any regulated emissions. Also included in our comparison is the CO<sub>2</sub> emitted by each vehicle. Emissions comparisons are made on a gram per mile basis since the regulations are currently stated in these terms. The results of this comparison are shown in Fig. 2.

### Conventional Automobile

We have taken the Federal Tier 1 Light Duty Vehicle (LDV) emissions requirements (0.41 g/mile total hydrocarbons or HC, 3.4 g/mile CO, 0.4 g/mile NOx) as being representative of what the conventional automobile will be capable of in the near term. All LDVs must meet this standard by 1996. The emissions are estimated on the basis of meeting each requirement by a factor of two, i.e., one half the allowed emission (this is typical of today's vehicle certifications). The emissions are certified on the Federal Urban Driving Schedule.



### Battery Powered Electric Vehicle

The emissions from a battery powered vehicle should include the power plant emissions from generating the electricity used to charge the battery. Like all the cars in this comparison, the electric vehicle requires that 0.33 kW·h/mile be delivered to the wheels. Thus the fuel energy required by the battery power electric vehicle is 1.6 kW·h/mile. Utility emission factors for *natural gas-fired* power plants were recently reported by the Southern California Air Quality Management District in lb/MW·h as 0.02 HC, 0.4 CO, and 0.15 NOx [12]. Thus the effective emissions from the EV are 0.016 g/mile HC, 0.32 g/mile CO, and 0.12 g/mile NOx. This represents the optimistic emissions from the "Zero Emissions Vehicle" (ZEV) of the same weight, drag, and rolling resistance as today's 27.5 mpg car. The national mix of power plants includes many coal-fired plants that would contribute much greater emissions. The CO<sub>2</sub> emissions shown in Fig. 2 are based on a natural gas-fired power plant.

### Gasoline Hybrid

The same emissions for the conventional automobile are assumed for the gasoline hybrid. Since the majority of the HC and CO emissions come at startup, it may be necessary to electrically preheat some fraction of the catalyst prior to engine start. This should be easily accomplished by the controller, which should have continuous information about the remaining energy in the EMB and be able to anticipate engine start by several minutes.

### CNG Hybrid

The CNG hybrid is assumed to have the emission characteristics recently demonstrated by Chrysler Corporation on their CNG van project: 0.02 g/mile HC, 1.4 g/mile CO, and 0.02 g/mile NOx [13]. This was apparently accomplished with an advanced catalyst designed for natural gas emissions. Although this vehicle meets the California Air Resources Board (CARB) requirements for the Ultra Low Emissions Vehicle (ULEV), it was only certified for the Low Emissions Vehicle (LEV) standards [14].

### Hydrogen Hybrid

The NOx emissions from the optimized hydrogen engine are based on values (found in Ref. 9) of 0.018 g/MJ of engine output. Thermal NOx production is extremely low for very lean operation and is only slightly affected by compression ratio [11]. Without a catalyst, no further reduction of NOx is assumed. Even though there is no carbon in the fuel of the hydrogen engine, there will be some small contribution from lubricating oil, thus a place holder value of 0.005 g/mile has been arbitrarily assumed. Exact HC and possibly CO values may be very dependent on engine design and await the development of the optimized hydrogen engine. If the hydrogen used in the hydrogen hybrid is from renewable sources, there is no net contribution of CO<sub>2</sub>. The CO<sub>2</sub> contribution from making hydrogen from natural gas (a 68 percent efficient process) is shown in Fig. 2, because this is a likely hydrogen source during the transition to complete renewables while we await the cost-effective fuel cell.

## CONCLUSIONS

Our estimates of vehicle energy efficiency indicate that a hydrogen fueled, piston engine hybrid can be built with an efficiency comparable to the PEM fuel cell hybrid. The emissions of such a hybrid, although not zero, like the PEM fuel cell hybrid, are comparable to those from a natural gas-fired power plant that supplies the energy to charge a battery powered electric vehicle. Because of the single load/speed operation and the previous research on hydrogen fueled piston engines, the development of an optimized hydrogen engine is a near term technology option. The capital cost of a piston engine hybrid operating a generator is likely to be less than an equal power fuel cell well beyond the near term. The use of piston engine technology to build a significant hydrogen infrastructure in preparation for the fuel cell should be considered as an opportunity to start the transition to a hydrogen economy in the near term.

In closing, it should be noted that the greatest improvement in energy efficiency can be achieved by reducing weight, improving the aerodynamics, and reducing rolling resistance of the automobile. The prototype GM Impact I required only

0.11 kW·h per mile at the wheels [15]. This is a factor of three less than the energy requirement assumed in this paper for representative current automobiles. Combining the characteristics similar to the GM Impact with the hydrogen piston engine hybrid concept results in an energy equivalent mileage of over 100 mpg, fuel costs (based on hydrogen from reformed natural gas) per mile that are comparable to today's conventional gasoline automobile, and emissions that should be classified as equivalent to the ZEV.

### Acknowledgments

This work performed under the auspices of the U.S. Department of Energy by the Lawrence Livermore National Laboratory under Contract No. W-7405-ENG-48.

### REFERENCES

- [1] *Hydrogen Program Plan FY1993-FY1997*, U.S. Department of Energy, Office of Conservation and Renewable Energy, Table C-1, June 1992.
- [2] J. B. Heywood, *Internal Combustion Engine Fundamentals*, New York: McGraw-Hill, Inc., 1988, ch. 5, p. 170.
- [3] R. F. Post, T. K. Fowler, and S. F. Post, "A High-Efficiency Electromechanical Battery," *Proceedings of the IEEE*, Vol. 81, No. 3, March 1993.
- [4] R. F. Post, private communication, August 1993.
- [5] E. F. Obert, *Internal Combustion Engines and Air Pollution*, New York, Harper & Row, 1973, ch. 8, Table 8-6, pp. 234-235.
- [6] I. F. Kuhn, Jr., "Comparative Performance of Onboard Hydrogen Storage Techniques for Vehicles," presented at Hydrogen Industry Council Conference, Montreal, Canada, 9 December 1992.
- [7] BMW AG, "Current Factbook—Hydrogen Drive," 1993, p. 3.
- [8] W. Peschka, *Liquid Hydrogen—Fuel of the Future*, New York: Springer-Verlag Wein, 1992, ch. 3, p. 67.
- [9] H. S. Homan, "An Experimental Study of Reciprocating Internal Combustion Engines Operated on Hydrogen," PhD Dissertation, Cornell University, 1978, p. 148.
- [10] M. Oehmichen, "Hydrogen as an Engine Fuel," Engine Laboratory of the Technische Hochschule, Dresden, Germany, VDI-Verlag GmbH, Berlin NW, V.D.I. Paper No. 68, 1942 (English translation).
- [11] L. M. Das, "Hydrogen Engines: A View of the Past and a Look into the Future," *International Journal of Hydrogen Energy*, Vol. 15, No. 6, pp. 425-443, 1990.
- [12] California Air Resources Board presentation at the South Coast Air Quality Management District's Hydrogen Task Force Meeting, Diamond Bar, CA, 23 September 1993.
- [13] R. J. Cogan, editor, "Chrysler Expands NGV Lineup," *Green Car Journal*, Vol. 2, No. 4, p. 38, April 1993.
- [14] C. Weaver, Engines, Fuels and Emissions Engineering, Inc., private communication, 28 September 1993.
- [15] C. A. Amann, *Energy and the Environment in the 21st Century*, Cambridge, MA: MIT Press, 1991, pp. 193-205.

## ON-BOARD PLASMATRON GENERATION OF HYDROGEN-RICH GAS FOR ENGINE POLLUTION REDUCTION

A. Rabinovich, D. R. Cohn, and L. Bromberg  
Plasma Fusion Center, Massachusetts Institute of Technology  
Cambridge, MA 02139

### ABSTRACT

An on-board compact plasmatron could provide a means to process gasoline or other hydrocarbon fuels (ethanol, methanol, natural gas, JP4, and possibly oil) to produce hydrogen-rich gas for vehicular internal combustion engines. Use of hydrogen-rich gas could substantially reduce NO<sub>x</sub>, CO, and hydrocarbon emissions. The electricity to provide the fuel processing in the plasmatron is provided by a generator driven by the internal combustion engine. When the hydrogen-rich gas is used as an additive to gasoline or other hydrocarbon fuel, the overall fuel efficiency could be approximately the same as that of a conventional gasoline engine. In the longer term, an on-board plasmatron could be useful in processing all of the hydrocarbon fuel into hydrogen-rich gas for a high efficiency fuel cell. The use of a plasmatron fuel processor could be particularly compatible with a hybrid vehicle.

### INTRODUCTION

Hydrogen is attractive as a fuel or additive for internal combustion engines, because it can significantly reduce air pollution and can also serve as an alternative energy source to gasoline [1-7]. Moreover, engine efficiency can be 10 to 50 percent higher than gasoline engine efficiency. However, using hydrogen as a fuel for vehicles requires large on-board high-pressure vessels or cryogenic containers if hydrogen is stored as a compressed gas or liquid, or large getter volumes and weights (if it is stored as hydride). Moreover, the refill time for hydrogen is substantially longer than that for gasoline.

A suitably designed plasmatron can provide an efficient and compact means of producing hydrogen-rich gas (H<sub>2</sub> and CO) from gasoline, diesel, and other fuels. The plasmatron utilizes electrical heating of ionized gases, providing a highly controllable means to process hydrocarbon fuel. The plasmatron could be used to turn all the hydrocarbon fuel into hydrogen-rich gas. However, there could be a large reduction in overall fuel efficiency due to the power requirements for the plasmatron.

An alternative is to use the plasmatron to process only a small fraction of the hydrocarbon fuel

into hydrogen-rich gas. The use of hydrogen-rich gas as an additive to gasoline facilitates rapid burn and completeness of combustion and allows operation on very lean fuel-air mixtures thereby reducing NO<sub>x</sub> emission. In this case, it could be possible to operate the plasmatron with only a small fraction of the mechanical energy of the engine. There could then be essentially no decrease in overall fuel efficiency, and substantial reductions in NO<sub>x</sub> and CO emissions could still be obtained. Use of plasmatron fuel processing could be particularly compatible with the gasoline engine-battery system in a hybrid vehicle.

### HYDROGEN ADDITIVE EFFECTS

It has been shown that by optimizing hydrogen-conventional fuel mixtures, it is possible to decrease NO<sub>x</sub> and CO by factors of 2 to 10. CO and NO<sub>x</sub> reductions by factors of 5 and 8, respectively, were obtained with hydrogen addition as low as 7 percent by mass [5]. Studies by Belogub and Talda of the effects of stored hydrogen addition on gasoline engine truck operation in town driving were made with engine operation that used a variable hydrogen mass fraction [2]. The average mass fraction of hydrogen,  $m_h/m_g$  (where  $m_h$  is the hydrogen mass and  $m_g$  is the mass of gaso-

line), was 14 percent. A 14 percent mass fraction corresponds to a ratio of hydrogen energy to gasoline energy of 42 percent. The mass fraction varied from approximately 4 percent to 25 percent depending upon engine load. The fuel efficiency (related to the energy content of the gasoline and hydrogen) was 17.5 percent higher for engine operation with the hydrogen additive relative to operation with gasoline alone.

Results from driving tests of Mercedes vehicles showed significant although somewhat smaller reductions of CO and NO<sub>x</sub> production, but at a modest increase of hydrocarbon emissions [4].

For diesel engines, hydrogen addition slightly increased the NO<sub>x</sub> and hydrocarbon emissions, while decreasing the CO and smoke and increasing the efficiency [5, 6].

On-board generation of hydrogen-rich gas using conventional steam reforming of gasoline has also been investigated as a means of reducing engine pollution by utilization of a mixture of hydrogen-rich gas and gasoline [7]. Water and gasoline were heated to 850 to 1100° C by burning gasoline in a chamber that was separate from the engine. The efficiency of conversion of gasoline into hydrogen-rich gas was about 67 percent. Substantial reductions in NO<sub>x</sub> and CO emission were observed in laboratory tests. Preliminary tests of operation with the steam reforming products (H<sub>2</sub>+CO) showed effects on engine operation that were similar to the effects of hydrogen. On-board conventional steam reforming, however, has problems that include low conversion efficiency, substantial size and catalyst requirements, carbon deposits, and warm-up requirements during start-up. These problems could be eliminated by plasmatron production of hydrogen-rich gas.

Due to the many variables involved in internal combustion engine operation, the quantitative advantages obtained through the addition of hydrogen can vary substantially. In addition, overall system effects including the impact of emissions control by catalytic converters must be taken into account. Catalytic converters were not used in the vehicles in which hydrogen gas/gasoline mixture effects were studied.

Use of three-way catalytic converter operation to reduce NO<sub>x</sub> would not be possible with the very lean operation employed with the hydrogen-rich gas/gasoline mixtures. However, very lean opera-

tion could greatly reduce NO<sub>x</sub> emission (possibly by more than a factor of 10) and catalytic converter operation could then be optimized for CO and hydrocarbon destruction. Moreover, the use of hydrogen-rich gas could be helpful in reducing emission problems in cold start-up where rich mixtures and the ineffectiveness of catalytic converters increase emissions of NO<sub>x</sub>, CO, and hydrocarbons. It could also reduce the adverse effects of the deterioration of catalytic converter performance over time. Thus use of plasmatron-produced hydrogen-rich gas in conjunction with an appropriate catalytic converter could greatly enlarge the air/fuel mixture-catalytic converter range of operation and could provide significant pollution reduction relative to conventional air/fuel mixture operation with a three-way catalytic converter.

### COMPACT PLASMATRON TECHNOLOGY

Based upon work in the former Soviet Union [8] and on experiments with larger plasma devices [9], compact plasmatrons could produce hydrogen-rich gas from gasoline and other hydrocarbon fuels with greater than 90 percent efficiency (conversion of electricity into thermal processing energy). More than 90 percent of the hydrocarbon fuel could be converted into CO and H<sub>2</sub> with water plasmatrons.

The plasmatron device (also known as a plasma reformer) produces an ionized, electrically conducting gas that is electrically heated. A mixture of hydrocarbon fuel, hydrogen, and water is heated in the plasma to 1000–3000° C at atmospheric pressure. The high temperatures achieved with the plasma increase the desired reaction rates without the use of catalysts. As a result of the large reaction rates, the size of the reformer is substantially decreased.

Gaseous or liquid hydrocarbons are converted by steam in the plasma by the reaction:



(where *m* and *n* represent the relative amounts of carbon and hydrogen) producing hydrogen-rich gas [10].

Since it has been demonstrated that addition of hydrogen to gasoline results in a very complete

oxidation of gasoline, it is also to be expected that CO would be completely burned.

It may be possible to use the plasmatron to process a number of other fuels for internal combustion engines in addition to standard gasoline. These fuels include lower cost gasoline, ethanol, methanol, natural gas, JP4, and possibly oil. The capability of the plasmatron to process different fuels provides the option of using the fuel from one tank for the generation of hydrogen-rich gas and combining the hydrogen-rich gas with gasoline or some other fuel from another tank.

An illustrative plasmatron for hydrocarbon reforming with water is shown in Fig. 1. An arc plasma is created between the inner (anode) and outer (cathode) coaxial cylindrical electrodes and is rotated by a magnetic force from a magnetic coil in order to prevent erosion of electrodes. The water (or mixture of water and liquid hydrocarbons) feeds into the space between two electrodes. Gaseous or liquid hydrocarbons can also feed independently into the zone of the rotating arc. The inner electrode (anode) does not utilize water cooling and works as a heater to turn the water into steam.

The plasmatron system weight would be around 10 kg. The plasmatron length would be around 20 cm. Plasmatron power levels would be in the range of a few kilowatts. The plasmatron could be used in cyclic operation to optimize performance. A small amount of hydrogen would be stored in the cyclic operation mode.

### SYSTEM EFFICIENCY

The efficiency of the overall system is determined by an energy balance as shown in Fig. 2. A given mass of gasoline (or some other fossil fuel) is combined with hydrogen-rich gas and injected into the engine.

The net mechanical energy available for powering the vehicle is:

$$E_{\text{mech,net}} = \eta_e \cdot (E_{g,e} + E_p \cdot R \cdot \eta_p) - \frac{E_p}{\eta_g} \quad (2)$$

where:

$\eta_e$  is the the thermal efficiency of the engine,

$E_{g,e}$  is the chemical energy of hydrocarbon fuel (for example, gasoline) into the engine,

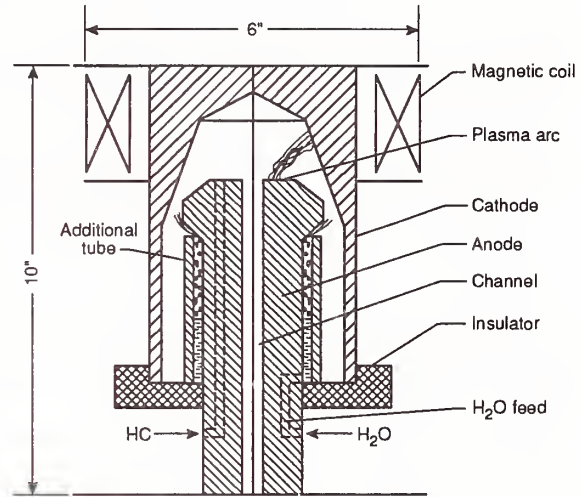

Figure 1. Water plasmatron.

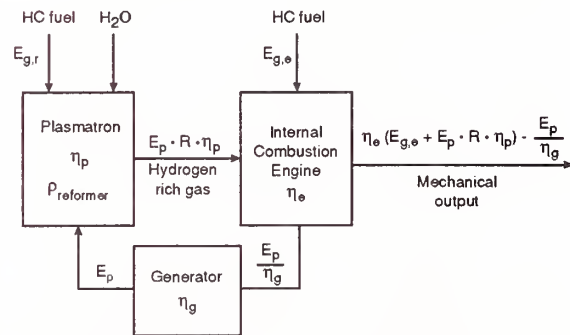

Figure 2. Energy and mass flow diagram

$E_p$  the electrical energy requirement of the plasmatron,

$\eta_p$  is the efficiency of the plasmatron in converting electrical heating energy into thermal energy,

$\eta_g$  is the generator efficiency, and

$R$  is the ratio of the chemical energy of reformat gas to the thermal energy supplied by plasmatron.

The parameter  $R$  is determined from the heating value of hydrogen-rich gas and the specific power requirement for equilibrium steam conversion of liquid hydrocarbons:

$$R = \frac{\rho_{\text{ref}} E_{g,r}}{\eta_p E_p} \quad (3)$$

where:

$E_{g,r}$  is the chemical energy of hydrocarbon fuel into the plasma reformer, and

$\rho_{ref}$  is the ratio between chemical energy available in the hydrogen-rich gas and energy of hydrocarbon fuel into the plasma reformer (for different grades of gasoline  $\rho_{ref} = 1.23-1.3$ ).

There is a wide range of R values that could be applicable. R varied between 4.3 and 5.4 for different grades of gasoline. For methanol, R is 7.4.

The overall system efficiency of a hydrogen-rich gas additive engine is the net mechanical energy divided by the sum of the fuel energy into the plasma reformer and into the engine.

$$\begin{aligned} \eta_s &= \frac{E_{mech,net}}{E_{g,e} + E_{g,r}} \\ &= \eta_e \frac{(E_{g,e} + E_p \cdot R \cdot \eta_p) - \frac{E_p}{\eta_g}}{E_{g,e} + \frac{E_p \cdot R \cdot \eta_p}{\rho_{ref}}} \\ &= \frac{\eta_e \left(1 + \frac{E_p \cdot R \cdot \eta_p}{E_{g,e}}\right) - \frac{E_p}{\eta_g E_{g,e}}}{1 + \frac{E_p \cdot R \cdot \eta_p}{E_{g,e} \cdot \rho_{ref}}} \end{aligned} \quad (4)$$

It is possible to calculate  $E_p/E_{g,e}$  from the mass fraction of hydrogen-rich gas additive, X.

$$\begin{aligned} X &= \frac{m_{(H_2+CO)}}{m_{gas,e}} \\ &= \frac{\left(\frac{E_p \cdot R \cdot \eta_p}{HV_{(H_2+CO)}}\right)}{\left(\frac{E_{g,e}}{HV_{hcf}}\right)} \end{aligned} \quad (5)$$

where:

$HV_{(H_2+CO)}$  is the heating value of hydrogen-rich gas additive, in MJ per kg of  $H_2$  and CO, and

$HV_{hcf}$  is the heating value of hydrocarbon fuel (such as gasoline) into the engine, in MJ per kg of fuel.

Thus:

$$\frac{E_p}{E_{g,e}} = X \cdot \frac{1}{R \eta_p} \cdot \frac{HV_{(H_2+CO)}}{HV_{hcf}} \quad (6)$$

Combining (4) and (6)

$$\begin{aligned} \eta_s &= \left[ \left(1 + X \frac{HV_{(H_2+CO)}}{HV_{hcf}}\right) \cdot \eta_e \right. \\ &\quad \left. - X \cdot \frac{1}{(R \cdot \eta_p \cdot \eta_g)} \cdot \frac{HV_{(H_2+CO)}}{HV_{hcf}} \right] \\ &\quad \cdot \left(1 + \frac{1}{\rho_{ref}} \cdot \frac{HV_{(H_2+CO)}}{HV_{hcf}} \cdot X\right)^{-1} \end{aligned} \quad (7)$$

Using the results of Belogub and Talda [2], the overall fuel efficiency of a hydrogen-rich gas additive engine can be determined from Eq. 7. Taking into account the energy content of  $H_2$  and CO, the amount of energy that would be added to the gasoline by addition of 14 percent hydrogen mass hydrogen would require a 73 percent mass addition of hydrogen-rich gas. If  $\eta_e = 0.25$  and  $\eta_p = \eta_g = 0.9$  and  $R = 4.3$ , the overall fuel efficiency  $\eta_s = 0.18$ . In contrast, for an engine operating with pure gasoline, it can be assumed that the thermal efficiency would be 17.5 percent lower [2] and that the fuel efficiency of gasoline-only engine operation would be 0.21. Thus under these assumptions, the addition of hydrogen would result in a moderate decrease in overall fuel efficiency.

It may well be possible to obtain significant reductions in NOx and CO emissions by use of a much smaller mass fraction of hydrogen-rich gas. For example, if a 2 percent mass fraction addition of hydrogen, which is equivalent to an 11 percent mass fraction addition of hydrogen-rich gas, were used, the plasmatron power requirement would be greatly reduced. The case for the addition of a 2 percent mass fraction of hydrogen has been considered in a U. S. Department of Energy, Hydrogen Program Plan for FY1993-FY1997, which was developed by the Office of Conservation and Renewable Energy [11]. In this document an example was considered where internal combustion engine efficiency was increased by five percent to 0.20 and NOx was reduced by a factor of 2.6.

Using  $R = 4.3$ ,  $X = 0.11$  and the values of  $\eta_p$  and  $\eta_g$  considered above and taking  $\eta_e = 0.20$ , the value of  $\eta_s$  is 0.19. Thus for this case, the overall system efficiency is only slightly changed. Moreover, for such low values of mass fraction addition, the overall system efficiency is relatively insensitive to any decrease in R or plasmatron efficiency.

In general, a variety of tradeoffs between hydrogen mass fraction, compression ratio, timing,

and overall system efficiency may provide optimum operating parameters. In addition, operation on 100 percent hydrogen-rich gas, under special circumstances would be attractive for certain situations.

Using advanced control technology (already implemented in modern fuel injected vehicles), it may be possible to develop an engine system where operation can be readily switched while driving between 100 percent gasoline operation, hydrogen additive operation and 100 percent hydrogen-rich gas operation.

In addition to water plasmatron operation (steam reforming), it may also be possible to use other plasmatron reforming modes (including partial oxidation). These modes of operation could reduce the plasmatron power requirement.

The plasmatron-internal combustion engine system could be particularly useful for hybrid vehicles. The presence of a significant battery and generator capability in the hybrid vehicle would allow more flexibility in operation of the plasmatron. In addition, the internal combustion engine could be operated with parameters that maximize thermal efficiency ( $\eta_e$ ). In this case, the effect of the plasmatron electricity requirement on overall power balance would be minimized. Moreover, it may be possible to optimize the internal combustion engine design to facilitate operation with extremely lean fuel mixtures (equivalence ratio less than 0.4). Extremely lean operation could provide further reduction in NO<sub>x</sub> emissions [7].

## CONCLUSION

On-board plasmatron generation of hydrogen-rich gas could provide a means to substantially reduce NO<sub>x</sub>, CO, and hydrocarbon emissions and facilitate the use of fuels other than gasoline (diesel, oil, methanol, ethanol) in hybrid vehicles. It might be used in diesel and turbine engines as well as spark ignition engines. It is possible that this technology could be implemented in a relatively straightforward way. Significant improvement in pollution reduction might be possible without radical changes in hybrid vehicle design. In the longer term, on-board compact plasmatron technology could be useful to reform a variety of hydrocarbons for use in fuel cells. The high efficiency of fuel cells could allow use of the plasmatron to process all of

the hydrocarbon fuel into hydrogen-rich gas without an unacceptably large loss in overall system efficiency. Important issues for investigation in the development of suitable compact plasmatron technology include high hydrocarbon and electrical conversion efficiencies, reliability, and lifetime.

## REFERENCES

- [1] A. I. Mishchenko, A. V. Belogub, G. B. Talda, V. D. Salitsky, and V. A. Baikov, "Hydrogen as a fuel for road vehicles," in *Proceedings VII of the World Hydrogen Energy Conference*, Vol. 3, 1988, pp. 2037-2056.
- [2] A. V. Belogub and G. B. Talda, "Petrol-hydrogen truck with load-carrying capacity 5 tons," *Int. J. Hydrogen Energy*, Vol. 16, pp. 423-426, 1991.
- [3] K. S. Varde and L. K. Varde, "Reduction of soot in diesel combustion with hydrogen and different H/C gaseous fuels," *Hydrogen Energy Progress V*, Vol. 4, pp. 1631-1641, 1984.
- [4] K. Feucht, W. Hurich, N. Komoschinski, and R. Povel, "Hydrogen drive for road vehicles-results from the fleet test run in Berlin," *Int. J. Hydrogen Energy*, Vol. 13, pp. 243-250, 1988.
- [5] A. V. Chuveliov, "Comparison of alternative energy technologies utilizing fossil fuels and hydrogen based on their damage to population and environment in the USSR and East Europe," in *Hydrogen Energy and Power Generation*, T. Nejat Veziroglu, Ed., New York, New York: Nova Science Publisher, 1991, pp. 269-300.
- [6] L. M. Das, "Exhaust emission characterization of hydrogen-operated engine system: Nature of pollutants and their control techniques," *Int. J. Hydrogen Energy*, Vol. 16, pp. 765-775, 1991.
- [7] R. Breshears, H. Cotrill, and T. Rupe, "Partial hydrogen injection into internal combustion engines," in *Proceedings of the EPA 1st Symposium on Low Pollution Power Systems Development*, Ann Arbor, MI, Oct. 1973, pp. 268-277.
- [8] E. M. Rudjak, A. Rabinovich, and N. A. Tul, USSR Patent 700935, Water Plasmatron, pp. 1-2, Aug. 1979.
- [9] G. Kaske, L. Kerker, and K. Muller, "Hydrogen production by the Huls plasma-reforming process," *Hydrogen Energy Progress VI*, Vol. 1, pp. 185-190, July 1986.
- [10] A. L. Suris, *Handbook of Thermodynamic High Temperature Process Data*, Washington, D. C.,

New York, New York and London, United Kingdom: Hemisphere Publishing Corp., 1987, pp. 510-530.

- [11] U. S. Department of Energy, Office of Conservation and Renewable Energy, Hydrogen Program Plan, FY1993-FY1997.



# THERMO-ELECTRIC-COMPOUND ENGINE FOR HYBRID VEHICLES

M. A. Paul

Chairman and CEO, Engine Corporation of America  
Fullerton, CA 91765

## ABSTRACT

Advanced Engine Technology, Engine Corporation of America, Advanced Fuel Systems, The Institute for Advanced Engine Technology, and Clean Power Propulsion Systems have formed the consortium, Advanced Propulsion Technology, which is developing engine technology for the presidential initiative, i.e., an 80-mile-per-gallon vehicle. Fundamentally new engine concepts have been developed that demonstrate the capability of running a thermal engine at enormous pressures. These high pressures are achieved for the first time in the history of thermal engines. This unique performance was made possible by eliminating key technical barriers that have stopped the evolution of conventional engine technology.

## BACKGROUND

The Turbo-roto-compound engine concept represents the culmination of 30 years of fundamental and applied research, theoretical and experimental data, and laboratory and industrial accomplishments and has resulted in numerous U.S. and international patents.

The engine concept is based fundamentally on thermodynamic laws, which provide an undeniably solid basis for the research program. The main thrust of this engine concept is to produce the highest pressure thermal cycle possible. The pressures achieved are well above those obtained in current state-of-the-art engines, which are limited to pressures of 120 to 140 atm. The engine concept discussed here is pushing pressures to new frontiers: 250 to 300 atm.

Basic thermodynamic laws indicate that thermal efficiency depends directly on the peak combustion pressure. Compression ratios between 30 and 50-to-1 indicate thermal efficiencies of:

$$\eta_t = 1 - \frac{1}{\epsilon^{k-1}} = 75 \text{ to } 80\%, \quad (1)$$

for values of  $\epsilon$ , the compression ratio, between 30 and 60. The constant  $k$  in the above expression is the adiabatic exponent, which has a value of approximately 1.41. Producing a pressure at compression of 214 kg/cm<sup>2</sup> can result in

a peak combustion pressure of 300 kg/cm<sup>2</sup>. This level of permissible pressures will create conditions for enormous supercharging levels: supercharging pressure ratios as high as 20-to-1 may be achievable. The projected power densities are enormous, with a BMEP (brake mean effective pressure) of 70 kg/cm<sup>2</sup>, the power density is 700 hp/l for a 2-cycle engine running at 4500 rpm. This is totally inconceivable for conventional engines.

To attain these goals it is necessary to overcome basic conceptual and structural barriers that have blocked further advances in engine technology for the past 100 years. The Monocylinder Test Rig (MTR) was developed to demonstrate that these barriers could be eliminated and to establish new limits for engine technology. The recently demonstrated values have established new frontiers that are now opening the possibility of achieving enormous increases in power density and efficiency in future engines.

The MTR incorporates normal materials, production bearings, normal surface quality, normal heat treatments, and, in general, normal industry standards from current production technology. The main questions addressed are: How much can we push the highest pressure in the thermal cycle? And, for the same peak pressure, how much can we extend the life of the engine?

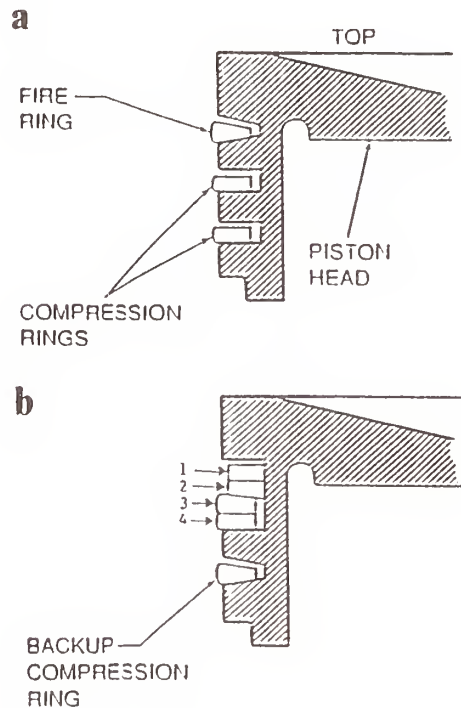

**Figure 1.** Piston-ring design detail. a) Detroit Diesel Corporation production type ring configuration used in initial motoring tests. Peak cylinder pressure tested up to 2200 psi. b) ECA "4-ring" high-pressure ring pack. Peak cylinder pressure tested up to 4100 psi.

The main barriers that have been eliminated are:

1. The cylinder head, cylinder head valves, push rods, rockers, cams, high-pressure gaskets, etc.
2. The side force between the piston and cylinder liners.
3. Piston structure for high mechanical and thermal stress.
4. The piston rings, with high back pressure.
5. Single injector per cylinder incapable of working at high supercharging level and part load at low supercharging level.
6. Cylinder block and cylinder liner structural stresses by tensions, proportional with the load and peak pressure.

The new concept is based on structural and fundamental principles which are:

1. Opposed piston engine—without cylinder head, gaskets, valves, etc. (Flt. 1).
2. Counter rotating mechanism, eliminating the side force and improving engine balance (Flt. 2).
3. Piston rings without back pressure (Fig. 1).
4. Piston with isotropic, spherical articulation.
5. Multiple injectors per cylinder, working sequentially on variable load and having variable injection length and time.
6. Symmetrical active force clamping the block and the opposed crankcases, pre-compressed by longitudinal bolts.

By pre-loading the engine, the pre-compressed structure of the block and the crankcases are relaxed during combustion, creating an enormous capacity for high peak pressure and high power density.

These concepts were integrated in a monocylin-der structure, and tested in two steps:

**Cold rig test.** The objective of this test was to demonstrate and simulate the highest level of the mechanical loads and the structural strength and integrity for all the components. The test rig was tested by loading the engine structure by varying the supercharging level and the engine speed. The focus of this research was the working area and articulations.

**Hot rig test.** The objective of this test was to demonstrate the basic combustion process for different combustion chambers and injection systems. In this phase, the main focus was to test the injection system. The injection system had two injectors per cylinder, and different injector tips, orientations, and tip geometries were tested.

Subsequent tests have concentrated on the performance of the high-pressure fuel pump, electronic system, the general functionality of systems critical for the combustion process, and the overall performance of the engine.

## TECHNICAL SUPPORT

Advanced engine technology has been demonstrated by Engine Corporation of America by a project sponsored by the U.S. Department of Defense through the Defense Advanced Research Project Agency (DARPA). This research was conducted in cooperation with Detroit Diesel Corporation; Sandia, Los Alamos and Lawrence Livermore National Laboratories; and a group of U.S. Universities. The major objective of the project include:

- Highest combustion pressure: 250–300 atm.
- Highest supercharging level: 5, 10, 15, and 20-to-1.

The potential engine advances that will result from this research include:

1. Highest power density.
2. Lowest pollutant.
3. Lowest fuel consumption.
4. Multi-fuel engine, i.e., liquid or gas.
5. A dramatic reduction in cost of production and exploration.
6. Universal use, i.e., military or commercial.

Advanced Fuel System was sponsored by the U.S. Department of Defense, DARPA, Sandia and Lawrence Livermore National Laboratories, with the participation of Korody-Colyer and Electramotive, Inc. Work was completed on an initial purchase order from Engine Corporation of America. This research demonstrated:

1. The highest fuel injection pressure in the history of engines (50, 60, 75, and 105×1000 psi).
2. Total gasification of the liquid fuel.
3. Pilot and main injection.
4. Total electronic control.
5. Total freedom of application to any kind of engine, without structural modification.
6. The design will fit existing engines and is thus suitable for after-market conversions.
7. The design will fit new engines and is thus suitable for OEMs.

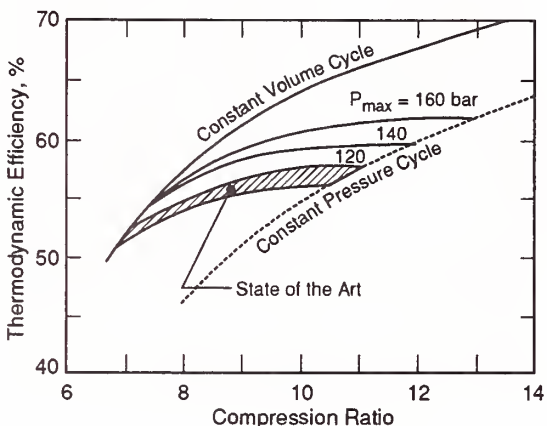

Figure 2. State-of-the-art engine efficiency.

## DISCUSSION

Basic thermodynamic laws indicate that maximum combustion pressure and maximum compression ratios produce the maximum thermodynamic efficiency. This is shown schematically in Fig. 2. Additionally, fundamental test results, which are shown in Fig. 3, in relation to B.S.F.C. (brake specific fuel consumption),  $\text{NO}_x$ , and  $P_{\text{max}}$ , indicate that  $\text{NO}_x$  reduction and improved fuel efficiency depend on the same factors: maximum pressure of combustion and maximum compression ratio. Thus for maximum results improvements in two areas are needed: 1) Advanced engine technology to run at the highest peak combustion pressure and the highest compression ratio. 2) Advanced fuel systems to operate at the highest fuel injection pressure and to improve total control of the process.

With the help of the thermodynamic diagram shown in Fig. 4, the thermal cycles for state-of-the-art and the ECA engines, as well as the Carnot cycle may be compared.

**State-of-the-art engines.** The thermal cycle having a limited peak pressure  $P_2$  of 120 bar and a maximum temperature of the cycle  $T_{\text{max}}$ , which in Fig. 4 is  $T_3$ , represents the actual level of the current engine technology.

The thermal efficiency

$$\eta_t = \frac{\text{Useful Work}}{\text{Invested Energy}}. \quad (2)$$

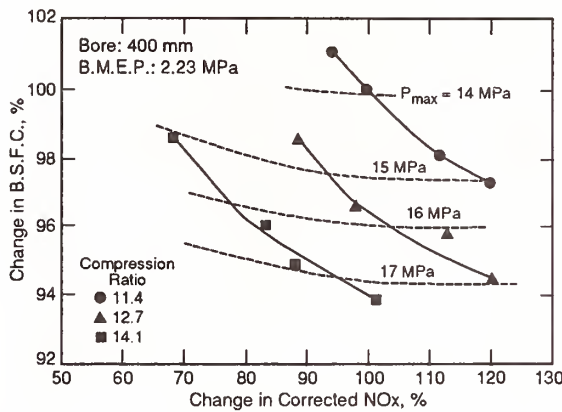

**Figure 3.** Fundamental test results showing the relation among B.S.F.C., NO<sub>x</sub>, and P<sub>max</sub>.

The Total Invested Energy is represented in the figure by the area enclosed by the curves connecting points: A, 2'', 3, 4, 5, and A. For the remainder of this discussion, I will adopt the convention of designating the enclosed area by the set of vertices. Thus the Useful Work is the area (1, 1', 1'', 2'', 3, 4, 1), and the Lost Energy is shown by the sum of (A, 1'', 1', 1, A<sub>0</sub>, A) and (A<sub>0</sub>, 1, 4, 5, A<sub>0</sub>).

The efficiency for current production engines is limited to approximately 40 percent.

**The Carnot cycle.** For the same temperature drop, T<sub>3</sub> - T<sub>1</sub>, the Carnot efficiency

$$\eta_t = 1 - \frac{T_1}{T_2}, \quad (3)$$

which is shown schematically in the figure by the ratio

$$\eta_t = \frac{(A_1, B, C, 5.1, A_1)}{(A, B, C, 5, A)}. \quad (4)$$

It is easy to see the enormous difference in thermal efficiencies between the actual cycle and the equivalent Carnot cycle. The area which represents the missing useful energy is the sum of (2'', B, 3, 2''), (A<sub>1</sub>, 1'', 1', 1, A<sub>1</sub>), (1, 5.1, 4, 1), and (3, C, 4, 3). **The Engine Corporation of America (ECA) thermal cycle.** The ECA thermal cycle with maximum peak pressure of 300 bar, and the same maximum temperature is also shown in the figure. The areas representing this cycle are:

Invested Energy: (A, 2''', 3', 3'', 5'', A)

Useful Work: (1, 1', 1'', 2''', 3', 3'', 4'', 1), and

Lost Energy: (A, 1'', 1', 1, 4'', 5'', A).

The thermal efficiency of the ECA cycle for this pressure is much higher than the current production engines and ranges between 50 and 70 percent.

The area that represents the missing useful energy in comparison with the same Carnot cycle is the sum of (A<sub>1</sub>, 1'', 1', 1, A<sub>1</sub>), (1, 4'', 5.1'', 1) and (2''', B, 3', 2'''), which demonstrates how close the ECA cycle is to the Carnot cycle.

This is the fundamental achievement, which has been demonstrated in the DARPA program by tests conducted with the monocylinder test rig.

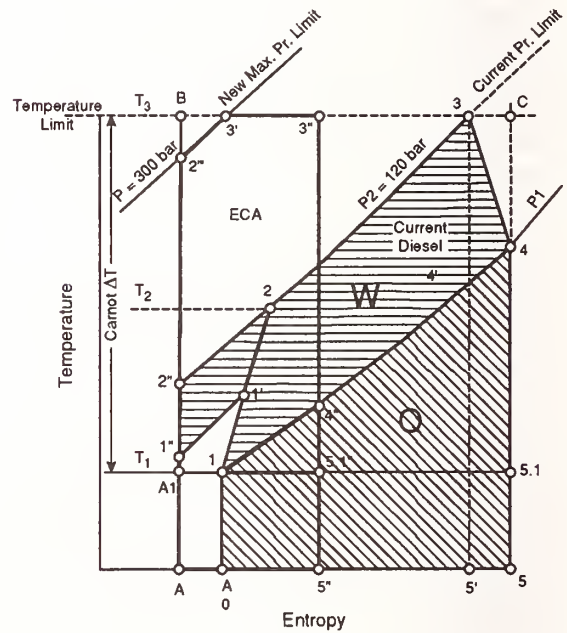

**Figure 4.** Comparison of thermodynamic cycles.

### COMPARISON WITH STATE-OF-THE-ART ENGINES

A comparison of the performance of the MTR with two of the best production engines is provided in Table 1. The engines chosen for this comparison are top performance military engines and are:

1. The German-made MTU-12V-880 engine. This engine is the top performer for tank engines. It has a 4-stroke cycle and is characterized by a BMEP of 16.1 kg/cm<sup>2</sup> (4 cycle)

**Table 1.** Comparison of monocylinder test rig results with state-of-the-art engine performance

Engine	Bore (mm)	Stroke (mm)	Speed (rpm)	Piston Speed (m/s)	Power (hp)	BMEP (kg/cm <sup>2</sup> )	Power per cyl. (hp)	Power Density (hp/l)	Cyl. Displ. (l)
MTU-12V-880	144	140	3000	14	1500	4 cycle 16.1**	125	54.7**	2.28
MTR	123	128/2	2000*	4.26*	112*	2 cycle 16.8 (4 cycle 33.6*)	112	74.6*	1.5
			3000	6.39	168	2 cycle 16.8* (4 cycle 33.6*)	168	112	1.5
			4000	8.52	230	2 cycle 16.8* (4 cycle 33.6*)	230	153	1.5
			6570	14	367	2 cycle 16.8* (4 cycle 33.6*)	377	251	1.5
12V-92 TA-MAR	123	128	2300	9.8	1034	2 cycle 10.95	86.2	57.8	1.5

\* tested 718° F exhaust 120° F intake

\*\* reference 1292° F exhaust 81° F intake

and a piston speed of 14 m/s at 3000 rpm. These three parameters in conjunction are unmatched by other existing engines.

- The American-made 12V-92 TA-MAR engine. This engine is designed for military and maritime applications. It is characterized by a BMEP of 10.95 kg/cm<sup>2</sup> (2 cycle) and a piston speed of 9.8 m/s at 2300 rpm.

These engines are of world-class technical status.

The MTR demonstrated a net superiority over both engines by achieving a BMEP of 16.8 kg/cm<sup>2</sup> (2 cycle). This is equivalent to 33.6 kg/cm<sup>2</sup> (4 cycle), which is more than double the BMEP for the MTU-12V-880 and more than 153 percent of the value for the 12V-92.

Power density, i.e., horsepower per liter, is a very important consideration and is best compared at equivalent piston speeds. In the most recent tests, the MTR was limited to 2000 rpm and a piston speed of 4.26 m/s, due to the limited rotational speed of the injection pump, which was supplied by DTC/DDC and was driven at 4000 rpm, i.e., twice the engine speed. Considering a piston speed of 14 m/s, which is similar to that obtained in the MTU-12V-880 engine, the MTR engine must be compared at 6570 rpm. The projected MTR power density at that engine speed is five times larger than the MTU-12V-880 or the 12V-92.

Limitations imposed by the fuel injection system are another important consideration: The fuel injection system used for these tests was the first available and supplied only 30 percent of the fuel that was supposed to be delivered to the MTR. If this situation of fuel starvation can be eliminated, the theoretical limit of the MTR power density will be fifteen times the power density of the MTU-12V-880 engine. Achieving these projected performance levels, which are beyond all existing production engines, depend on the production of an adequate fuel system.

The basic condition for the potential realization of these huge increases in performance has already been demonstrated by the achieved top pressure of 4000 psi, which in the near future can be extended to pressures approaching 5000 psi. This type of peak combustion pressure is opening the perspective to a supercharging pressure ratio of 20-to-1, in comparison with 2.5 and 3.5-to-1 actual pressure ratios used in modern production engines.

Achieving total pressure ratios of between 300 and 340-to-1, for expansion ratio, the thermal efficiency can reach the enormous level of over 70-75 percent. This is in comparison with 20 to 35 percent efficiencies for current production engines.

At these peak pressures, combustion can be made virtually pollutant free by a total multi-fuel

capability and an ultra-lean mixture. Based on these considerations, the goal of the U.S. presidential initiative for the development of an 80-mile-per-gallon vehicle is now realistically achievable.

#### REFERENCES

- [1] U.S.A. Patent No. 4,791,787 December 20, 1993. Regenerative Thermal Engine. Inventor: Dr. Marius Angelo Paul.
- [2] U.S.A. Patent No. 4,809,646 March 7, 1989. High Pressure Reciprocator Components. Inventor: Dr. Marius Angelo Paul.
- [3] U.S.A. Patent No. 4,964,275 October 23, 1991. Multicylinder Compound Engine. Inventor: Dr. Marius Angelo Paul.
- [4] U.S.A. Patent No. 5,058,537 October 22, 1991. Optimized High Pressure Internal Combustion Engines. Inventor: Dr. Marius Angelo Paul.

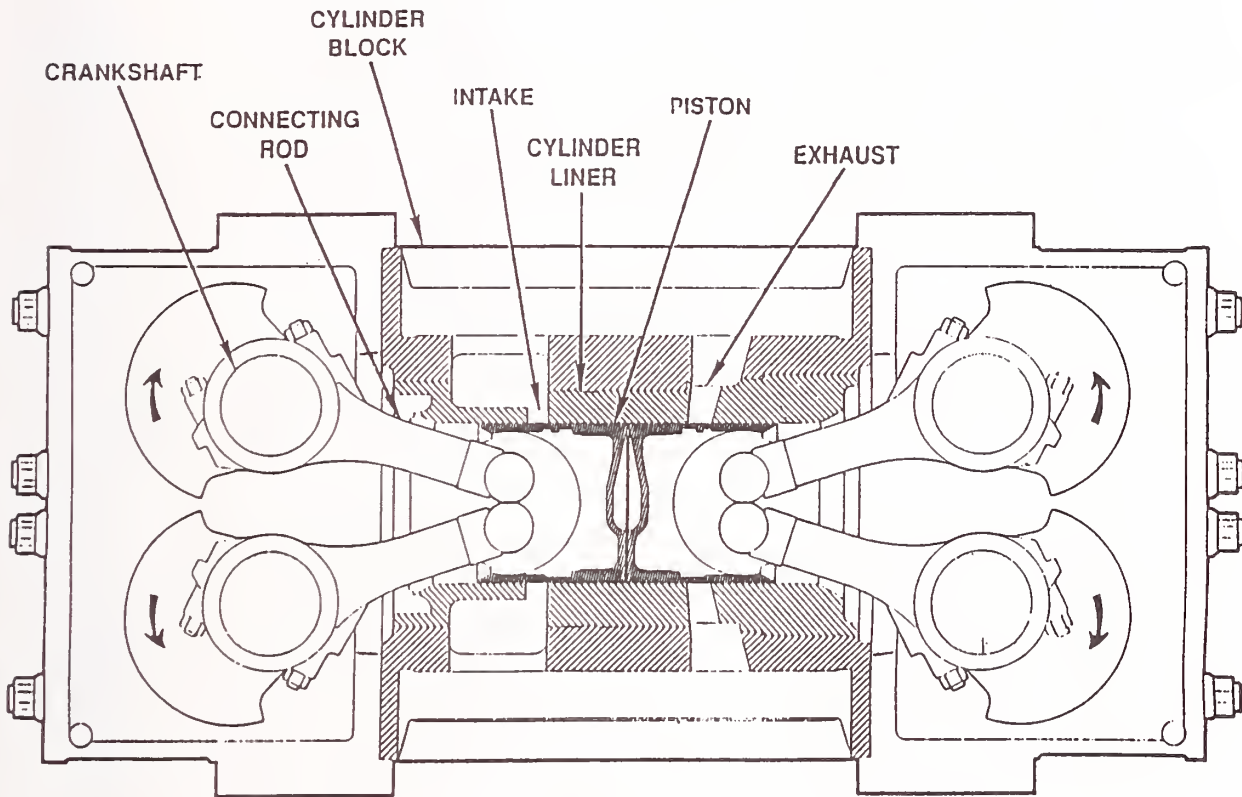

Float 1: Monocylinder test rig assembly. Four cylinders into one.

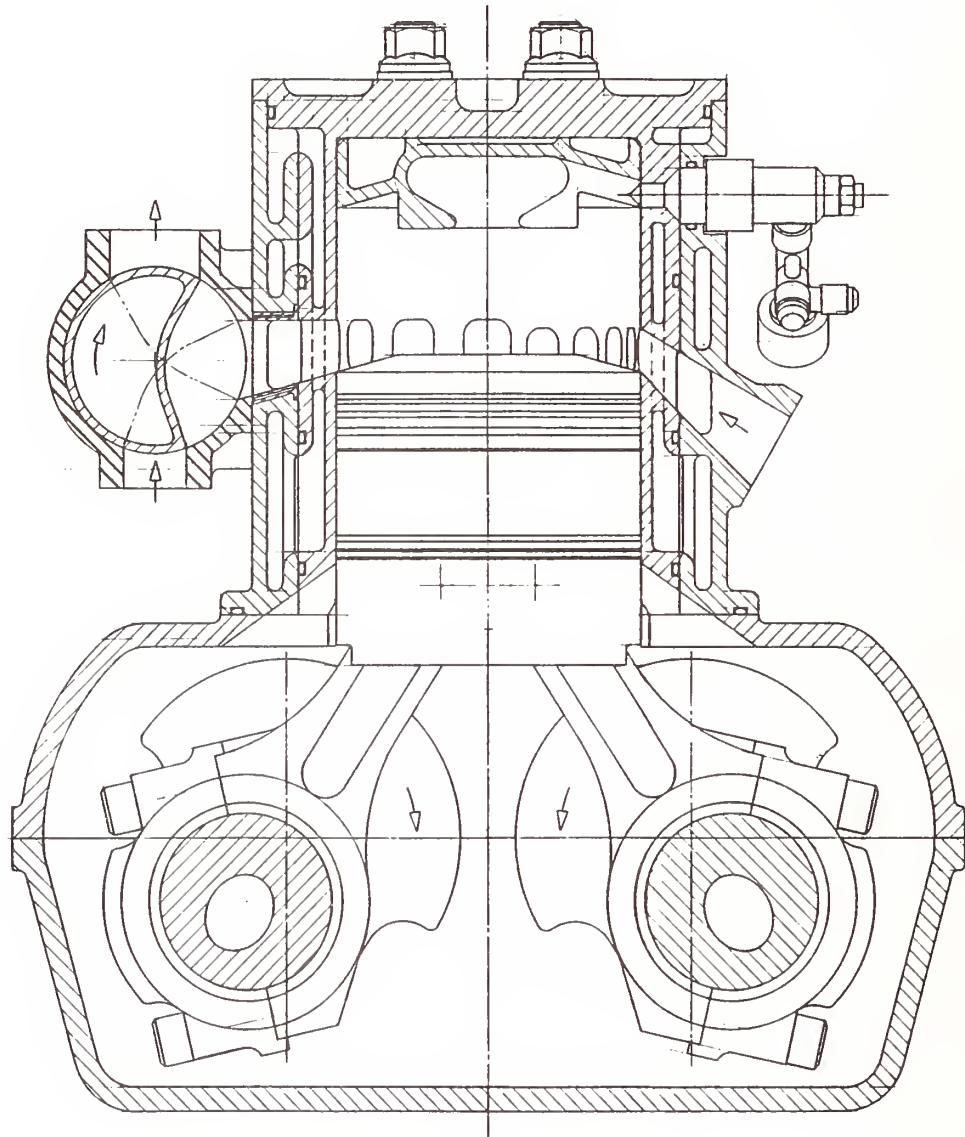

**Float 2:** Monocylinder test rig assembly. Two cylinders into one.



## PHOSPHORIC-ACID FUEL-CELL BUS DEVELOPMENT

R. J. Kevala  
H Power Corporation  
Belleville, NJ 07109

### ABSTRACT

In comparison with diesel and other alternative-fuel technologies, fuel cells offer the potential for both reduced emissions and increased fuel economy for buses. The phosphoric-acid fuel-cell (PAFC) bus with an on-board methanol reformer can be refueled rapidly by filling its tank with methanol. It is essentially a zero-emission vehicle without the range and payload limitations of a battery-powered vehicle.

A 9-meter (30-ft) fuel-cell-powered transit bus is under development that will ultimately be used for revenue service demonstration. Fuel-cell power is augmented by a battery, which also acts as a reservoir for excess fuel-cell and regenerative-braking energy. The bus retains most of its accessory components that have been proven in transit service, and integrates them with newly-developed fuel-cell, battery, and electric-drive-train components. System integration is a key component of the design, fabrication, and assembly process.

### INTRODUCTION

Fuel cells generate electric power through electrochemical reactions involving hydrogen and oxygen. In the transit bus application, the hydrogen needed by the fuel cell is derived from a mixture of pure methanol and water. A traction battery is used to provide added power for acceleration and grade climbing. The battery also acts as a reservoir for excess energy from the fuel cell and regenerative energy from the traction motor during braking and downgrades. The mission of the project is to provide a proof-of-concept for fuel-cell technology in transit-vehicle applications; to demonstrate its suitability for use by transit agencies; and to demonstrate and quantify the environmental, fuel economy, and other benefits of fuel cell-technology. An artist's rendering of the bus is shown in Fig. 1. The project is sponsored jointly by the U.S. Department of Energy (DOE), the U.S. Department of Transportation, and California's South Coast Air Quality Management District. The technical management team for the project includes representatives from DOE, Argonne National Laboratory, and Georgetown University. H Power Corporation is the prime contractor, with Booz•Allen & Hamilton Inc., Bus

Manufacturing USA Inc., Fuji Electric Corporation, Soleq Corporation, and Transportation Manufacturing Corporation as team participants.

### FUEL CELL/BATTERY BUS DESIGN

The *Baseline Advanced Design Transit Coach Specifications* [1], (commonly referred to in the transit industry as the "White Book") was used as the design starting point. Although the bus is referred to as a test-bed bus, it is designed for durability and reliability. All major non-propulsion components on the test-bed bus are service-proven. The operating range should exceed 240 kilometers (150 miles). The performance and gradability requirements for the test-bed bus are shown in Table 1.

A major design challenge was to maintain the look and feel of a standard transit bus while benefiting from a radically different power plant. Compatibility with typical transit industry operations and maintenance practices was also a key consideration.

The bus has been designed to comply with the Federal Motor Vehicle Safety Standards and the transit vehicle accessibility provisions of the Americans With Disabilities Act. The bus should also

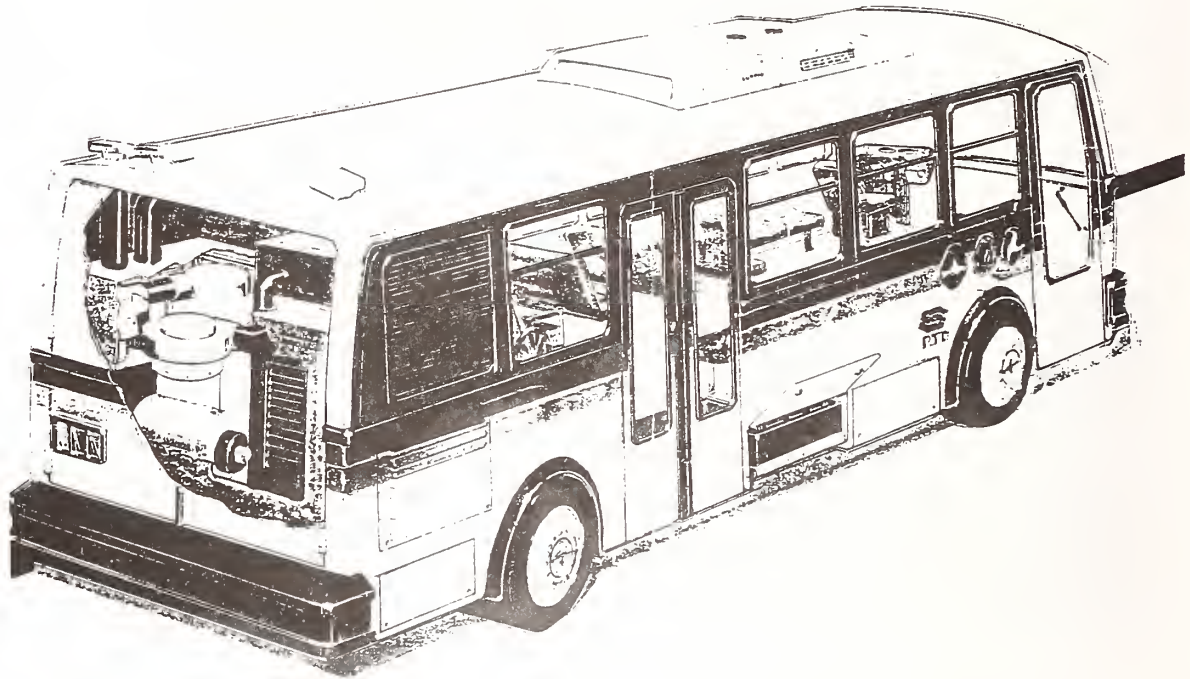

Figure 1. Artist's rendering of the test-bed bus.

surpass any applicable air quality standards since it will emit extremely minute levels of pollutants, and only during the start-up process, essentially making it a "zero emission" vehicle.

### BUS COMPONENTS AND SUBSYSTEMS

The hardware configuration of the bus is shown schematically in Fig. 2.

#### Fuel cell subsystem

Major components of the fuel cell subsystem include the fuel cell stack and a variable "up-chopper" to match fuel cell voltage to the battery under different battery states-of-charge and bus operating conditions. Hydrogen is produced in a steam reformer from a feed-stock of neat methanol and water. Control of the fuel cell sub-

system is performed by a microprocessor-based internal controller. The fuel cell subsystem also includes a number of variable speed pumps, blowers, solenoids, and other auxiliary equipment. The fuel cell subsystem is located in the rear, where the engine would be in a standard bus. Automatic hydrogen detection and fire-suppression systems are provided on the test-bed bus for safety.

#### Battery subsystem

The 216-volt battery consists of eighteen SAFT STM5-200 nickel-cadmium battery modules, arranged in three bays under the bus floor. The battery sub-system also contains cooling fans and a semi-automatic watering system. Compared with battery-only electric vehicles, the test-bed bus battery is subjected to higher charge-discharge current levels during bus operation. Accelerated life cycle tests have indicated a life in excess of three

**Table 1.** Test-bed bus performance and gradability requirements

Acceleration:	
0 to 10 mph	5.6 s
0 to 20 mph	10.1 s
0 to 30 mph	19 s
0 to 40 mph	34 s
0 to 55 mph	60 s
Average speed:	
0% grade	58 mph
2.5% grade	44 mph
16% grade	7 mph

years for the battery.

### Electric and mechanical power train

The power train includes a separately-excited DC traction motor, a complementary metal oxide substrate (CMOS)-based motor controller, line filters and reactors, a drive shaft, and a standard differential housing and rear axle. There is no transmission. The motor is chassis-mounted behind the rear axle.

### System controller

A microprocessor-based system controller is needed to oversee and optimize the operation of the various subsystems, particularly the fuel cell, battery, and electric power train. The system controller provides interfaces with other vehicle subsystems via voltage and other sensors, RS-232 communication ports, and other devices. Its primary functions are:

- Energy and power management
- Battery state-of-charge calculation
- Fault monitoring and annunciation
- Operator interface
- Data acquisition and logging for engineering tests and maintenance.

For energy management, the two most important system controller output signals are the

fuel cell power level request and the regenerative traction current limit. The system controller is also capable of momentarily shutting down non-essential bus accessories to save energy when needed. The central processing unit (CPU) is a hardened IBM 386 PC, running MS-DOS.

### Heating, ventilation, and air conditioning subsystem

The heating, ventilation, and air conditioning (HVAC) subsystem uses mostly off-the-shelf components, but the configuration is significantly different from that of a diesel bus. The refrigerant compressor is driven by a DC motor that is mounted under the floor (similar to electric trolley buses). The evaporator/condenser unit is mounted on the roof. A specially designed heat exchanger is built into the fuel cell stack cooling loop to transfer waste heat into a separate cabin heating loop.

### Operator's controls

Many of the operator's controls are standard, such as the master run switch, door controls, wheelchair lift control, and parking/emergency brake. A standard transit bus layout is used, with front and left-hand side instrument and control panels. However, some non-standard controls are needed. A rotary switch and two indicator lights are needed for fuel cell control. Other non-standard items include an emergency shutdown push button, a traction ammeter, a system fault indicator, and a motor stall indicator.

### Bus body/chassis

The test-bed bus body is of mild steel semi-monocoque construction, based on an existing structural design. Two fuel tanks are needed—a large one for the methanol/water premix and a small one for the neat methanol that is used in the fuel cell start-up and reformer burners. An infrared-activated fire suppression system is installed in the fuel cell compartment, in the battery compartments, and over the fuel tanks. The air compressor and power steering pump are belt-driven by a single DC motor. Nearly all other accessories and furnishings are standard and are powered by either 24-volts or 12-volts DC.

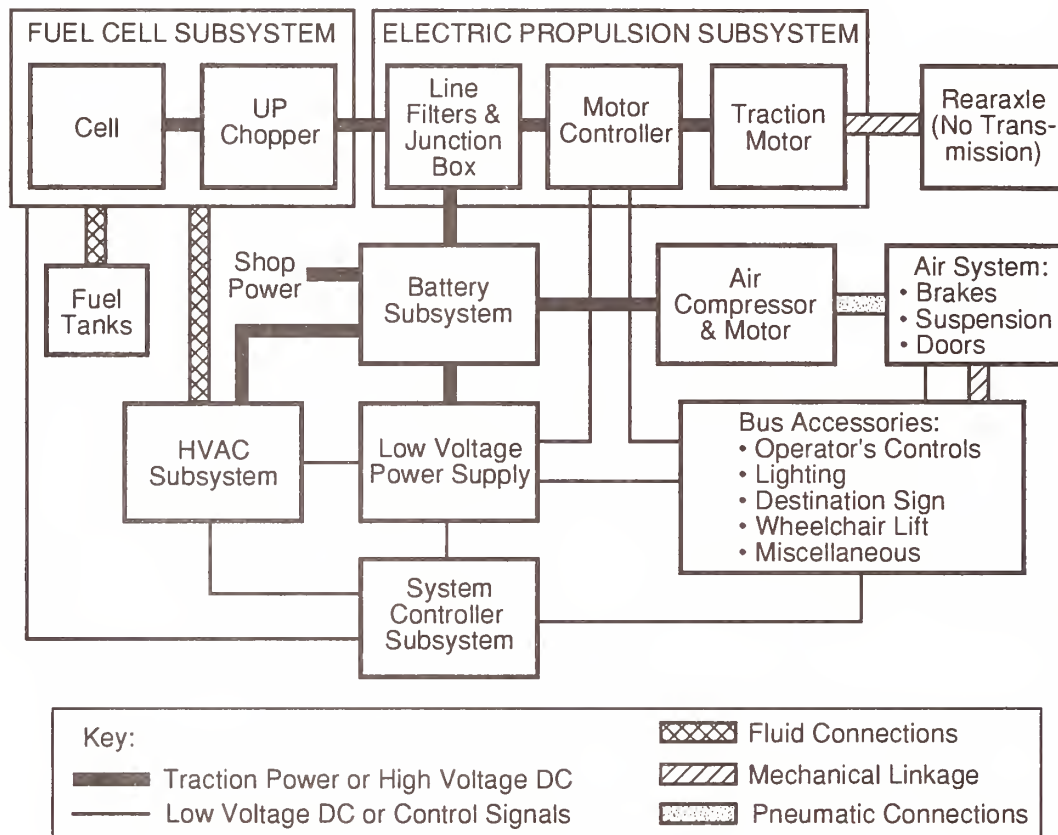

Figure 2. Test-bed bus hardware configuration.

## SYSTEMS INTEGRATION

The test-bed bus development and design has been significantly more complex than the design of a diesel-powered bus. The power plant is a hybrid and uses technologies that are in the developmental stage. Furthermore, key propulsion and other components are built and supplied by multiple sources and are being integrated into a working vehicle for the first time. There is a mix of standard and non-standard transit equipment, and the interfaces between electrical and other components are particularly complex. Finally, there was a need to modify some components so that the overall system would be optimized in terms of energy consumption, performance, payload, and weight. To deal with these complexities, a structured in-

tegration process was implemented to develop the system design. First, equipment subsystems were defined, as listed in the preceding section. Particular emphasis was given to defining the electrical and mechanical interfaces between subsystems, so that each supplier worked to a specific set of design constraints. Detailed technical specifications for each subsystem were then prepared, so that the overall mission requirements would be incorporated into the detailed hardware design. Next, a critical design review (CDR) took place, after which detailed designs were prepared and released for fabrication. Individual component testing was performed concurrently with the CDR, to provide data and resolve specific issues. The CDR was followed by hardware fabrication, subsystem qualification tests, and testing of the completed

**Table 2.** GUTS cycle characteristics

Route Length:	13.1 km (8.2 miles)
Schedule Time:	33–35 minutes
Number of Stops:	45
Maximum Speed:	72 km/h (45 mph)
Maximum Grade:	7.02%
Minimum Grade:	-14.14%
Average Grade:	2.67%

test-bed bus. To assist in many of the major design decisions, a FORTRAN-based simulation program known as "Hybrid 27," originally developed by Georgetown University, was used. This program simulates the test-bed bus performance, power plant behavior, and other operating characteristics over anticipated revenue routes, and has been calibrated from the brass-board and laboratory test data. Two routes were used in the model to verify that performance requirements will be met:

- Transit Coach Duty Cycle (TCDC). The standard transit bus operating duty cycle (Central Business District/arterial/commuter cycle) documented in the White Book [1].
- Georgetown University Transportation Society (GUTS) Cycle. It is a demanding route profile on which the test-bed bus is expected to operate. The GUTS cycle is summarized in Table 2.

### CURRENT STATUS

The test-bed bus design is now complete. The bus body and all major subsystems have been fabricated and assembled. Fabrication and testing of some electronic components such as the fuel cell up-chopper and low-voltage power supply are under way.

Following fuel cell subsystem verification and acceptance tests in December 1993, the fuel cell will be integrated into the assembled test-bed bus. Engineering evaluation testing of the assembled test-bed bus will begin in early 1994. The bus is scheduled to be delivered to DOE in June 1994.

### SUMMARY AND CONCLUSIONS

A structured system integration process was followed because the power plant technology is complex, many of the bus components are in the developmental stage, and several suppliers are involved. The emphasis was on optimizing the system as a whole, rather than on individual components. A number of specific design problems were encountered and resolved using the system integration process.

A number of additional development efforts will be needed before the bus can be considered for commercial route operation. These efforts include:

- Development of an improved battery, more suited to the specific demands of hybrid power application
- Improvements in the transient response time of the fuel cell subsystem
- Recovery of water from the fuel cell exhaust to avoid the need for carrying water on board the bus for fuel reformation
- Reduced size and weight of major components and bus structure
- Better integration and consolidation of the packaging of smaller components
- Consolidation of all control functions into a single unit

The design of a 12.2-meter (40-foot) fuel cell and battery hybrid transit bus is currently being investigated by Transportation Manufacturing Corporation.

### REFERENCES

- [1] *Baseline Advanced Design Transit Coach Specifications*, Urban Mass Transit Administration, U.S. Department of Transportation, Washington, DC, April 4, 1977.

## ZERO-EMISSION TECHNOLOGY PROJECTS

M. A. Bogdanoff and J. H. Leonard  
South Coast Air Quality Management District  
Diamond Bar, CA 91765

### ABSTRACT

The South Coast Air Quality Management District has adopted a comprehensive air pollution control program in the Los Angeles area. To expedite air quality attainment, the Technology Advancement office was created to identify and foster the development of low-emission technologies and clean fuels. California's Zero-Emission Vehicle (ZEV) mandate was primarily adopted to address the extraordinary air quality problems of the Los Angeles area. Consequently, Technology Advancement has cosponsored a number of projects to promote ZEV and Electric Vehicle (EV) technology including battery development, vehicle demonstrations, fuel-cell development and concept studies. Based on progress to date, it appears that EV technology is on schedule to meet California's two-percent ZEV mandate in 1998.

### INTRODUCTION

The South Coast Air Quality Management District (AQMD) is responsible for comprehensive air pollution control in the Los Angeles area. This four-county air basin has the nation's worst air quality, and consequently, needs extraordinary measures to attain ambient air standards. The AQMD's Technology Advancement program was created by the California Legislature in 1987 and is mainly funded through a vehicle registration surcharge of \$1 per vehicle. Its purpose is to identify low-emission technologies and clean fuels that would contribute to air quality attainment, and to foster their development and commercialization through public-private partnerships. Technology Advancement has an annual budget of about \$7 million and has cosponsored over 100 mobile- and stationary-source projects valued at \$66 million, including matching funds from the private sector.

In 1990, the California Air Resources Board (CARB) adopted very stringent emission requirements for new vehicles starting with 1994 models. These include a declining fleet-average standard for non-methane organic gases as well as a Zero-Emission Vehicle (ZEV) mandate. This mandate affects larger vehicle manufacturers and requires that 2 percent of their 1998 California production be ZEVs. This mandate gradually increases to 10

percent for the year 2003 and subsequent model years.

California's ZEV mandate was adopted primarily to address the extraordinary air quality problems of the South Coast Air Basin. In the 1991 Air Quality Management Plan, it was estimated that 50 percent of new passenger cars and 35 percent of light-duty trucks would need to be ZEVs in order to meet the clean air goals (The 1994 Air Quality Management Plan is now under development). Thus, Technology Advancement is highly focused on ZEV technologies and is working closely with CARB to expedite the introduction of ZEVs. In addition, Technology Advancement is committed to the development of sustainable energy technologies such as photovoltaics and wind power.

The AQMD has a number of projects to advance ZEV electric-vehicle (EV) technology including battery development, vehicle demonstrations, fuel-cell development, and concept studies.

### ADVANCED BATTERIES

The sealed bipolar lead-acid (SBLA) battery has the potential to deliver a unique combination of advantages not found in other near-term EV batteries. These advantages include: higher specific power (vehicle acceleration and hill-climbing), improved specific energy (vehicle range), longer bat-

tery life, lower cost, and good thermal characteristics for hybrid vehicle applications. The AQMD and CARB are co-funding the development of two SBLA battery projects.

Testing of the Arias Research SBLA battery conducted at Idaho National Energy Laboratory demonstrated peak power of 950 W/kg, which exceeded the 750 W/kg goal (100 percent SOC, 10 seconds to 2/3 OCV). However, the achieved specific energy of 47 W·h/kg was 94 percent of the 50 W·h/kg goal (C/2 rate). Life-cycle testing by another independent laboratory yielded more than 2000 cycles (C/2 to 50 percent DOD).

A second project with Polydyne, Inc., is to develop and demonstrate the SBLA battery design from Pinnacle Research. This battery concept differs from Arias in the design of the bipolar plate. The goal of this battery is high energy storage (greater than 60 W·h/kg) and high specific power (greater than 1 kW/kg) without degradation of battery life. Independent battery testing is being performed at Wright-Patterson Air Force Base.

## EV DEMONSTRATIONS

The AQMD is adding a number of EVs to its fleet. In 1992, the AQMD purchased a Destiny 2000 from Solar Electric Engineering. This vehicle, based on a Pontiac Fiero with manual transmission, uses deep-cycle, lead-acid batteries to achieve a claimed range of approximately 40–60 miles per charge. However, most drivers were disappointed by the vehicle's limited range, slow acceleration, and rapidly declining power as the battery pack was discharged. Subsequently, Solar Electric replaced the Destiny 2000 with an improved model, derived from the Ford Escort. This vehicle was delivered in April 1993.

The AQMD purchased a Honda CRX conversion from AC Propulsion, a small business in the South Coast Basin. This vehicle includes a state-of-the-art alternating-current drive train and sophisticated regenerative braking system. The vehicle has excellent performance, can accelerate from 0 to 60 mph in 8 seconds, and has a usable range of approximately 100 miles. This vehicle has exceptionally low energy consumption averaging only 0.116 kW·h per mile. It uses a 336-volt battery pack of Optima 800S batteries; however, the life of these batteries is reduced through ex-

tensive high-power operation.

The AQMD has also ordered ten EV conversions from Advanced Electric Car Technologies (AECT), another small business in the Basin. These vehicles are converted Hyundai's that include the Elantra, Excel, and Scoupe models. AECT has developed a conversion system based upon their low-amperage modular lead-acid battery cell. This modular approach allows battery cells to be placed throughout the vehicle to best utilize existing space. The vehicles are expected to have a 60–80 mile range. During the first year of operation, selected vehicles will undergo FMVSS crash testing, and range and performance tests will be performed by CARB.

To facilitate EV recharging and demonstrate zero-emission power generation, the AQMD has installed a photovoltaic charging system consisting of a 3,000 square foot, semi-crystalline, 24 kW array at a fixed angle, 19-degree from horizontal. The system is mounted on a carport at the AQMD's headquarters. Inverters convert the solar-generated DC power into alternating current, which can be used by conventional EV recharging systems. The system is designed to provide at least 73 kW·h per day of electrical power for about nine months of the year. This energy output corresponds to the amount of electrical energy required to recharge a current-technology electric van, such as the G-Van, from an 80 percent depth of discharge.

## ULTRACAPACITOR TECHNOLOGIES

Pinnacle Research has developed a state-of-the-art ultracapacitor that stores five orders of magnitude more energy than a conventional capacitor, and at least twice the energy of any supercapacitor. AQMD and CARB are co-funding the development and construction of large ultracapacitors capable of powering an electrically heated catalytic converter in a conventional automobile (24 kJ). Eight of these large, brick-sized ultracapacitors are now under construction and will be installed in two vehicles. This technology may also be applicable for regenerative braking and providing high power for acceleration and hill climbing. Hybrid battery-ultracapacitor power packs are also feasible.

## FUEL-CELL TECHNOLOGIES

Fuel cells have the capability to power ZEVs and have the potential to replace internal combustion engines as the primary power plant for both mobile- and stationary-source applications. However, additional research, development and demonstration efforts are needed to overcome technological and institutional barriers that currently limit the wide-scale use of fuel cells. Motor vehicle fuel cell applications pose particularly tough technical challenges. These include the need for high power, light weight, rapid start-up, long service life, ability to withstand shock and vibration, and safe convenient fuel storage.

To address the barriers facing fuel-cell vehicle commercialization, the AQMD has initiated the Ad Hoc Coalition on Fuel Cells for Transportation, which seeks \$450 million in federal funding for fuel cell research, development and demonstration over the next decade. Membership consists of about thirty public and private organizations, and is expanding.

Currently, most development work on fuel cells for transportation involves either the phosphoric acid fuel cell (PAFC) or the proton exchange membrane (PEM) fuel cell. The PAFC is a more near-term technology, but the PEM fuel cell has the potential to offer significant advantages over the PAFC for a broad range of transportation applications. It is smaller in size, weighs less, starts up faster, and is thus better suited for automotive applications. When fully developed, it could also be less costly than the PAFC.

The urban transit bus system is an attractive early entry point for transportation applications of both PAFCs and PEM fuel cells. A hybrid fuel cell/battery motor is capable of meeting the arduous power demands that are common to the transit bus driving cycle, while providing ultra-low emission levels and a substantial improvement in vehicle energy efficiency. Moreover, the AQMD's Air Quality Management Plan effectively targets 30 percent of the Basin's transit buses to be powered by electricity or fuel cells by the year 2010.

Other vehicle applications for fuel cells are very likely to follow transit buses as more advanced fuel cells are developed, such as the solid oxide fuel cell. The high-temperature solid oxide fuel cell offers high power while obviating the need for external

fuel reforming, but limited stack development and testing has occurred to date. Nonetheless, in 15 to 30 years it may very well become the preferred power plant for passenger cars, buses, trucks, locomotives, and other key transportation applications.

The Air Quality Management District is cost sharing a four-phase federal project to develop and demonstrate near-zero-emissions transit buses powered by a PAFC/battery hybrid motor. This congressionally sanctioned program is administered by the US Department of Energy (DOE) and US Department of Transportation. Phase I, a proof-of-feasibility demonstration, has been successfully completed. Phase II is now underway, with the objective to build three 27-ft. buses and to demonstrate at least one in the Basin beginning in late 1993. The prime contractor is H-Power Corporation and is responsible for fuel cell assembly and system evaluation.

Ballard Power Systems of British Columbia, Canada, is a leader in building PEM fuel cells and is working to improve performance at progressively lower cost. The British Columbia provincial government, in cooperation with British Columbia Transit, has commissioned Science Applications International Corporation (SAIC) and Ballard to build a proof-of-concept, 15-passenger transit bus powered by the latest Ballard PEM fuel cell design. The AQMD provided oversight of Phase I as a member the British Columbia Fuel Cell Bus Steering Committee.

Ballard and SAIC have now unveiled the completed and operational Phase-I bus. It is powered by a 120 kW PEM fuel cell using pure hydrogen and pressurized ambient air. Ballard and SAIC were able to build the bus on schedule and essentially on budget, although payload was compromised to keep the weight of the bus manageable.

The Ballard-SAIC team is now seeking funding for a multi-year, multi-phase program to develop at least three additional buses with an advanced PEM fuel cell system. This new system will target a lower-cost, more-efficient PEM, hybridized with a battery pack for added peak power and regenerative braking. The AQMD is co-funding this effort based on the intention of Ballard to demonstrate at least one bus in the Basin and perform much of the development work in Southern California. Ballard's work will focus on commer-



cializing the PEM fuel cell in 1998 for bus applications. They are targeting several key areas to bring down the cost of the PEM fuel cell to about \$500 per kW. These include a more-efficient, lower-cost membrane, more efficient catalyst usage, improved cell performance, and volume production (at least 5,000 stacks per year).

Energy Partners of West Palm Beach Florida has initiated an accelerated program to develop a ZEV passenger car powered by a fuel cell/battery hybrid. The AQMD, along with the US DOE, is cosponsoring this project. Energy Partners bought the rights to the Treadwell PEM fuel cell and has formed a new company, US Fuel Cells. Three pure-hydrogen, air-breathing 8 kW PEM fuel cell stacks have been fabricated for the Energy Partners "Green Car" and are being integrated into a light-weight monocoque sports car chassis built by Consulier. A lead-acid battery back provides peaking power requirements for the vehicle. This vehicle is now undergoing road testing.

The AQMD is also spearheading an effort with the DOE to evaluate the most promising fuel-cell technologies and fuels for locomotive applications. Jet Propulsion Laboratory is the contractor conducting the work for the Locomotive Propulsion System Task Force, an ad hoc committee comprised of academia, government, equipment manufacturers, fuel-cell technologists and, railroad operators. It is expected that the DOE will use this Phase-I study to implement a detailed systems design study on one or more leading fuel-cell technologies.

### CONCLUSIONS

EV technology development appears to be on schedule to meet the CARB 1998 ZEV mandate. SBLA batteries and ultracapacitors are under development and should meet the power requirements of near-term EVs. The SBLA batteries should have a specific power greater than 1000 W/kg and specific energy about 50 W·h/kg. Use of the Arias SBLA battery in the highly efficient AC Propulsion vehicle should yield nearly 200 miles range at 55 mph and have battery life greater than 50,000 miles. The SBLA batteries will likely compete with improved, conventional lead-acid and nickel-cadmium batteries. Batteries being developed by the US Advanced Battery

Consortium or others will likely appear after the turn of the century.

Many EV conversions are now appearing in the market place, although without standardized recharging hardware. In general, these vehicles have range and performance limitations but are providing an inducement and test bed for battery and EV component development. The AC Propulsion drive train system, however, does not have any performance compromises, although the life of conventional lead-acid batteries may be taxed and require early replacement under continual high-power modes (fast accelerations, constant hill climbing).

Progress is being made with fuel-cell technology and demonstration projects are beginning on small transit buses with PEM fuel cells and PAFCs. The Ballard PEM fuel cell bus is a milestone, but further research, development and demonstration fuel-cell investment is needed in order to attain zero-emission transportation.

### REMARKS

Communication with component manufacturers indicates that electric motors and controllers are developing with an effort to reduce cost and improve efficiency. Optimized EVs will likely use AC induction motors, have high-voltage systems greater than 300 volts, and not require transmissions. High-efficiency ancillary systems are also being developed such as air-conditioning compressors and power-steering pumps. Infrastructure issues such as recharging hardware and utility considerations are now under discussion in various technical committees, but these may require government intervention to achieve consensus.

## NON-TECHNICAL BARRIERS TO PRODUCT COMMERCIALIZATION

A. J. Sobey  
Automotive Consultant  
Bloomfield Hills, MI 48304

### INTRODUCTION

Many promising technologies and new vehicle concepts may never be marketed as useful, consumer or commercial products. This paper outlines some of the reasons why and includes some thoughts on how they could be overcome. A description of the steps in the commercialization of a new product provides the basis for discussions of the non-technical barriers that can cause a technically successful program to be societally valueless. While the discussion is based on new automotive vehicle propulsion systems, most of the comments apply to the commercialization of any major new technology.

Clearly one paper can not identify all of the problems or solutions. The objective of this paper is to provide investigators with some ideas on how to identify the barriers to the commercialization process. Have all of the problems been found? How should they be approached?

### STAGES IN COMMERCIALIZATION OF A NEW CONCEPT

Successful commercialization of new products or technologies will require careful planning for each stage from research to field service. The initial plans will inevitably be wrong. They should be updated as each new problem or opportunity is encountered. Before a serious investment is made in commercialization, public and private decision makers will want to understand if the plans will provide customers with useful economic vehicles that meet all safety, energy, and environmental standards and earn a profit. The plans should identify the uncertainties and define, in so far as possible, the probable range of performance, program duration and costs. If major, apparently unsurmountable, barriers are encountered, the sponsors have two options. First, drop the concept.

Second, devise strategies to minimize their delays. It is increasingly important to avoid wasting time and resources on research and development of unproductive, or second-best, technologies and concepts. When the development of a new technology or concept proceeds beyond basic research some additional questions need to be addressed. Firstly, how would the technology be applied? And, secondly, will the anticipated performance and cost be superior to existing technologies, or those that may be mature by the time the new concept could be commercialized?

The commercialization of new technologies and non-conventional vehicle concepts, such as all-electric or hybrid cars, will go through a series of steps. While each manufacturer will describe the steps differently, for the purposes of this paper I have divided the process into nine steps:

1. Confirm technical feasibility
2. Devise vehicle concepts to meet selected markets
3. Construct pre-production items for tests and demonstrations
4. Conduct market tests using pre-production products
5. Design for production
6. Create production capacity
7. Sell to willing buyers
8. Service (maintenance, energy sale, etc.)
9. Dispose of exhausted materials

The research stage on a new technical concept may take longest, but the cost and complexity of each step increases as the product approaches the

sale to end users. Each step requires different skills and facilities and encounters different problems.

Both industrial and governmental laboratories have encountered delays in transferring new technologies from the research to commercialization. The research managers may have good reasons for hesitating to declare a technology commercial. There will always be some things that have not been adequately defined—potential problems or troublesome unknowns. They may have serious personal concerns. If the researchers have spent decades on research on a technology, the transfer may mean loss of prestige, budgets, staff, etc. They may have to find new problems or concepts to work on. On the other hand, the laboratory's success should be measured by the value of the technologies that they develop and successfully commercialized.

### **Confirm technical feasibility**

Confirming the technical feasibility of a new concept requires more than laboratory demonstrations. Technical feasibility means that there are no apparent barriers to developing a concept that will meet the performance needs of the most probable applications. If it is a hybrid propulsion system it must be more efficient than competitive systems, provide adequate power for selected vehicles and be able to fit in the space available in a typical car or truck.

Confirming technical feasibility starts with the design and testing of an experimental bench or brass-board system that addresses critical engineering problems. Typical problems that may not be considered during research include; heat transfer, electrical resistance, material selection, strength, vibration sensitivity, volume, weight, limiting dimensions, etc. It will usually take a series of designs—each closer to what is needed—before a design suitable for use by the public is developed.

### **Device vehicle concepts**

While all of the possible applications for a new technology cannot be even guessed at in advance, it is important that the basic objectives of a new propulsion system; power, efficiency, emission levels, packaging, responsiveness, etc., be defined

carefully. Vehicle or platform designers will prepare studies of a number of "acceptable" vehicle concepts. These will provide the basis for estimating performance and space requirements, weight, drag, and customer acceptance and will establish the cost objectives for the new power plant.

### **Construct pre-production items for tests and demonstrations**

The process of testing, demonstrating, and introducing radically new vehicles will require building test vehicles, then incrementally larger numbers of vehicles to conduct demonstrations and meet initial sales forecasts. Car manufacturers build individual test units by hand, but when even relatively small numbers (fifty) are required, hand building appears to be the wrong way. Market demonstrations will require fifty to one-hundred cars. The first year's sales may be only a few thousand, the second year two to three thousand, etc. It typically takes five to seven years to achieve market penetration and high-volume production.

There is no organization that can build relatively small numbers of cars and light trucks economically. Studies are in process on two approaches [1]. First, develop the capability to assemble fifty to one-thousand vehicles in small geographically strategic facilities. Second, develop high-volume assembly lines in which every vehicle can be different in concept, size, purpose, and make.

### **Market test or demonstrate pre-production cars**

The industry has learned—to its dismay—that what appears intuitively acceptable to the market may not be. Before the first pre-production cars are built product "clinics" will be held to estimate public acceptance. The pre-production cars for market demonstrations will embody the results of these clinics.

Large scale demonstrations will be required when the cars differ significantly in performance, operation, or other characteristics from traditional products.

These demonstrations should be designed to provide the information needed to estimate the size of the market and their actual benefits (will

people use them). In these demonstrations a small fleet, fifty to one-hundred cars, should be operated by typical users. They should have the cars for a long enough period (probably one year) to overcome novelty effects and address the seasonal changes. The cars should be "near final" in appearance so that people will feel that they are "production" cars and not research vehicles.

Operation of pre-production cars or trucks by the public requires wavers to avoid the expense and time of conducting demonstrations of safety standards. Cars produced under wavers usually cannot be used for other than a specified demonstration. Even with wavers the manufacturers must still give careful attention to safety requirements as they will be liable for accidents caused by mechanical failures.

Most companies will continue to conduct market tests while the products go through the several redesigns that are usually required before the manufacturers are confident that the product is acceptable for public use and attractive to buyers.

### Design for production

Vehicle program managers are unwilling to commit a new technology to production until they are confident that it will perform adequately, have sufficient life, be competitively priced, and meet all energy, environmental, and safety standards. The designer of a vehicle incorporating a new technology, such as hybrids, will, for good reasons, limit the number of untried components. The primary tasks during this stage are to reduce labor and material costs while maintaining reliability and performance. Part counts will be analyzed to determine which parts can be combined. Tooling costs will be estimated and manufacturing processes developed. Material selections will be analyzed to determine if lower-cost or more easily manufactured materials will be acceptable. Tradeoffs will be made between material cost and labor content.

The industry has set goals of starting sale of new vehicle designs within three years of go-ahead. This can be done if there are no significant new technologies. New technologies take much longer.

### Create production capacity

It would be ideal if existing facilities and tools could be modified to produce the new technologies. However, this is unlikely with advanced propulsion systems such as battery electric or fuel cells. They differ in almost all respects from piston engines. Tooling, transfer lines, etc., designed for piston engines will no longer be needed. It is probable that new—specifically designed—facilities will have to be built. This applies to increased demand for some existing subsystems as well. There would be insufficient battery production capacity to meet the needs if large sale demand for battery electric, hybrid, or fuel cell cars develops.

The major manufacturers are gradually transferring the responsibility for systems and subsystems to the suppliers. While it is tempting to use "all new" there are good reasons for building on the prior experience that suppliers have developed. There are hundreds of companies that provide the automobile industry with everything from special tools to the complete design and prototype fabrication of new cars or trucks—under contract. Over half the value added in the automobile industry is produced by companies with less than two-hundred employees. Forty percent have less than seventy employees. The need for new strategies and products could lead to new business structures. There will be an increased role for material engineers and electro chemists. There will still be a need for the traditional "metal bending" companies.

### Sell to willing buyers

The goal is to produce new cars or trucks that are so attractive that a buyer, in a show room, will select the product with the new technology over more traditional designs. If initial costs are higher than traditional cars, because new technology is mandated to meet energy or environmental standards, costs may exceed people's transportation budgets. People may hold on to their old cars as long as possible. While it is arguable, government subsidies or other incentives such as use of high occupancy lanes, lower parking fees, etc., may be necessary.

### Service, maintenance, and energy supplies

Access to service and repair facilities and an adequate supply of fuel or energy, should be available before a new propulsion/energy supply concept can be successfully introduced. Some service items, special lubrication materials, for example, may be in short supply or found inadequate with field experience. Electric propulsion systems require maintenance equipment and service skills that do not exist in adequate quantity.

Repair and maintenance will be major items. Some advanced materials (for example composite structures) are difficult, or impossible, to repair and must be replaced. New repair approaches must be developed—it is unlikely that a car which would have to be scrapped when the chassis was damaged would be acceptable.

The availability of trained service personnel may delay the introduction of new propulsion systems. There will probably be more problems and will certainly be fewer people with appropriate experience. The need for effective service is one reason why first sales may be limited to selected regions where service facilities can be provided.

Availability of energy (fuel, electricity, etc.) should not be a problem during the demonstrations and introduction. The existing utility electrical systems should be able to support a fairly large number of battery electric cars almost anywhere in the United States. If conventional liquid fuels (reformulated gasoline, diesel, etc.) are used by the hybrids, the nation may actually have excess capacity. However, if fuel cells become a major portion of the market, a new kind of fuel (a true synthetic rather than a replicated fuel) may be required. This may require the construction of a new distribution system—a costly and time consuming process.

### Disposal

Until recently the disposal of worn out vehicles has not been a major concern to the manufacturers. There are two ways that the disposal problem could be approached.

- Recycle as much material as possible
- Rebuild the basic car

The incentives for recycling of materials has increased with the public's concern about the environment and aesthetics. Engines, doors, and fenders are sold by "junk yards" as replacements for cars that have been damaged. There is an established industry for recycling some materials (primarily lead and platinum). By some estimates, approximately seventy percent of today's cars can be recycled.

Some people think that the nation has been covered with fields of wrecks and abandoned cars. A semi serious proposal was made several years ago to require junk yards to spray all cars olive drab (or sand in the west) with a mixture of paint and materials that would accelerate corrosion and decomposition.

The requirement to maintain emission characteristics for nearly the life of the car, coupled with the introduction of materials such as; plastics, and electrical drives will make the useful life of a platform (chassis, engine, etc.) much longer than has been true in the past. Seats, tires, batteries, etc., all must be worn out. If the cars were designed for rebuilding even appearance and accommodations could be updated to comply with changes in the owners life cycle. Some remanufacturing is occurring for up-scale large cars (BMW's, etc.).

The sponsors face problems in estimating the cost of disposal. This is difficult for conventional cars, and perhaps impossible for cars incorporating new technologies until there is experience on the actual life of the components.

### BARRIERS TO COMMERCIALIZATION

While the technical and design problems may be serious. The most difficult problems to be overcome in the commercialization process may be what have been called the "non-technical barriers". These include:

- Underestimating the complexity of vehicle design
- Failure to plan for the market
- Availability of financial resources
- Return on investment
- Availability of services and skilled personnel

- Intellectual property rights
- Competition
- Business traditions
- Government contracting terms
- Inapplicable government regulations
- Demonstrating compliance with safety, energy, and environmental standards
- Product liability

### Understanding the complexity of vehicle design

This is not a barrier as such, but illustrates problems that if not addressed properly can create barriers. Advocates of new technologies are tempted to develop their program plans and estimate the costs based on an "ideal" or no problem program. But this seldom, if ever, occurs. Underestimating costs and over promising delivery times may help sell a program, but knowledgeable private and public decision makers will want to be assured that there are adequate allowances for design mistakes and major revisions before they provide their support. A friend who provides some financial support for promising start ups has two questions he asks each prospective entrepreneur. First, have you mortgaged your house? Second, what will the balance sheet and profitability look like if it takes you twice as long and costs twice as much to reach the market? In his experience, doubling of time and cost is common.

Failure to reach promised goals may result in loss of financial support. Accelerating the commercialization may create a negative reputation and jeopardize the complete program, if problems are encountered. The GM automotive diesel is a classic example. The company had successfully developed commercial diesel and gasoline engines. The primary objectives were to reduce costs and weight. The engine encountered many field problems and was withdrawn from service. But, before production stopped most of the field problems had been solved. If the company had taken a couple more years to obtain field experience and correct the problems before they were sold to the public, the engines might still be in production.

It is easy to underestimate the complexity of automobile design and manufacturing. At first glance cars appear less complicated than aircraft and guided missiles, since they are more forgiving of design errors, but this can be deceptive. The first digital computer simulations of automobile stability and handling required nearly twice as many lines of code as the computer models prepared by the same people for missile guidance and control [2]. Most of the factors (tires, suspension systems, body stiffness, etc.) that affect car handling are nonlinear—unlike missiles where linear models can be used.

Design for manufacturing involves not only sophisticated processing but complex inter-linking of suppliers and assembly lines to insure parts are delivered in time and that they are installed on the right cars. The Automobile Industry Action Group is an example of a major industry cooperative effort to develop more effective supplier manufacturer communications and data exchange. It was formed about a decade ago and involves several hundred engineers who participate on various committees and conduct tests.

### Failure to plan for the market

Most of us have heard of inventions looking for a problem to solve. Unfortunately many technical innovations fall into this category, sometimes because they are interesting academically, but not economically viable, or more frequently because their embodiment has not been based on an understanding of the market and how it may change. The configuration may be technically sound, but unattractive or no better than something else that is, or could be, used for the same service.

The sponsors should seek advice from those who know the market well—what sells, what do people object to, what information exists on the market performance of vehicles similar to those based on the new technology. A caution, if the changes are significant and the time at which they will be commercial far the future, existing market information may not be applicable. It is in these cases that market demonstrations using the new technologies will be important.

When there is little background on similar products the sponsors may have to take a risk and assume that an adequate market will develop when

people understand the benefits of the product.

### **Availability of financial resources**

Major new product developments, in particular propulsion systems, may require commitments of hundreds of millions of dollars over decades. Interestingly, the industry estimates of the cost of design and tooling for new conventional engines for automobiles, turbines for aircraft, and diesels for locomotives all are approximately one-billion dollars. Only the largest companies or the government can afford such investments.

There is an impression, which is to a great extent justified, that most innovations come from small innovative companies, usually start ups, because of their freedom to respond to changes. But small companies seldom have the facilities or technical expertise to determine which technologies will be useful or the ability to raise the capital required to commercialize them.

There are many requirements for capital. Other public expenditures like health may have more political visibility. Most private expenditures will be directed at meeting immediate problems, like future energy and environmental standards and foreign competition. A University of Michigan study [3] estimated that the U.S. Automobile manufacturers must spend \$140 billion on new car designs and \$84 billion on new truck designs, to compete with foreign suppliers. The Germans and Japanese are expected to spend more than \$300 billion to increase their penetration into the U.S. market. It is unlikely that the industry can generate or borrow this amount of money. These estimates do not include support for new technologies or concepts such as are being considered in this workshop.

Government support will depend on the projected societal (environmental, economic, mobility) benefits. The primary justification for government support of research on vehicle propulsion should be to evaluate new opportunities that would otherwise not be explored. The government may need to sponsor the development of potentially attractive technologies when the "risk" is too high to justify private investments. This support should be discontinued when the business plan shows adequate promise to interest private investors.

The requirement to meet near-term needs makes it difficult for private companies to justify any significant investment in "high-risk" technologies. Financial support from private sources will not be available in sufficient quantities until technical feasibility has been established and a reasonable business plan prepared. Commercial banks seldom invest in new products. Private capital should be available once the risks have been reduced to the point that a business plan can be prepared that confirms a high probability of being able to produce the products at an acceptable price and that enough people will buy them to earn a profit.

### **Return on investment**

Some private investors have stated that they cannot afford to invest in any business that will take more than three to five years to reach profitability. The commercialization of the propulsion systems of interest in this workshop will take decades. High performance batteries have already taken several decades and gas turbines at least as long. It will probably take several decades before fuel cells are cost competitive with piston engines.

The money invested in the research and development of a new product must be recovered if the sponsor of the commercialization is to be satisfied. This requires amortization of the investments and interest over the initial production. The basic price will include manufacturing, labor and materials, overhead, reserves for future problems, and profits. In the case of heavy vehicles, the interest charges, alone, on the first products may be as high as the manufacturing costs. The price must be increased to include the recovery of the research investment and interest.

Alternatively, the risk to private investors may be reduced by government subsidies for societally beneficial products, or subsidies may be given to purchasers of the new products to offset the increase in price above "traditional" products.

### **Availability of services and skilled personnel**

There are surprisingly few qualified scientists and engineers in many of the disciplines that will be important for the future cars. Examples include:

1. Design of fuel cells and

## 2. Production design of composite materials.

Aerospace engineers who are redundant because of the end of the "cold war" appear to be a logical source of needed skills. However the cultural barriers are serious. We must convert "cap and gown" engineers and scientists to "dirty finger nails" designers and engineers. I know from personal experience—it took me several years to change from a rocket scientist to a vehicle systems engineer and even more to understand the problems of the industry, how it operates and what it needs.

Orientation sessions on the needs of the industry, followed by days or weeks of brainstorming, supported by people who know the problems of the industry and its existing products, could provide the insights that aerospace engineers need to find ways that their backgrounds could be utilized in the automotive industry. Similar processes should lead to the creation of ideas on uses of aerospace technologies and perhaps to the creation of special businesses.

### Intellectual property rights

Before there will be major investments leading to commercialization the sponsors must be confident that they will be able to recover their investments. If there were no intellectual property protection (that is, patents, copy rights, company secrets) the next company could replicate the product and produce it at a price that the originator could not afford to match.

When several different kinds of organizations including government research laboratories have participated in a program, the assignment of intellectual property has caused serious delays. Obviously the researcher and the developer have different goals—the first for recognition, the second for profit. Unless the technical developments are reduced to practice, and sold, the researchers findings may contribute little if any to the public well being.

### Competition

New product development programs that take years or decades must not only allow for the emergence of competitors that provide similar products (an inevitable result if they are successful) but

must also consider the possibility that a competitive product will be developed that will be more useful, lower priced, longer lived, or have other advantages.

The risk of foreign competition is a major concern. All industrialized nations face similar problems, economically, environmentally, and societally, and are developing similar products. The German and Japanese have traditionally encouraged cooperation between the public and private sectors. This has given them an advantage in reducing new concepts to practice and in accelerating their commercialization.

The program managers and planners should continuously evaluate developments in other disciplines that could influence the intended market and the products sale and profitability.

### Business traditions

While most companies do not like to admit it, there are inherent barriers to innovation in mature companies. Many middle managers achieved their success in the "old" way. A new way is a threat. It may challenge their knowledge base, or in some cases their integrity. Investments in "older" plants, manufacturing processes, tooling, etc., can be a barrier, but if the new products offer the potential of high profit margins, prior investments are usually a less serious barrier than tradition or corporate culture. It appears to surprise some people, but in my last assignment at GM (determining how it could benefit from commercialization of new technologies) my support came from the Chief Economist, the top Financial Officer, the Vice Chairman, and the Vice President over the Technical Center, in that order.

### Government contracting terms

Government contracting processes can influence the technical progress and the acceptance of new technologies in two ways. First, in the contracting procedures for research and development programs. Second, in the process of selling products, such as transit vehicles, to government units, local, state, and federal. Existing procurement policies can be a problem in both cases.

The need for periodic competitive rebidding causes delays. In one cooperative program, be-



tween a state and an automobile manufacturer, it took more than two years to negotiate the contract. Similar delays have been encountered in the federal contracting process. The causes include: negotiation of intellectual rights, challenges from the losers, and the inability to agree on the work statement or the terms of cost sharing. Government decision makers should be able to authorize continuation of the efforts on attractive programs as long as major milestones are met.

Government contract program managers have little latitude to investigate new opportunities—they must adhere to work statements that may be a year or more old even if there are more promising paths. One oil company reported (Gulf) that it completed a major research project (related to synthetic fuels) for less than their matching share of a government contract that they had backed out of.

If the product is to be sold to a government agency (for example, mass transit) the manufacturer may encounter other cultural problems. Only a few transit authorities are willing to take a risk on a new concept. Local government officials have little incentive to select a new and better approach if older, successful, concepts can provide the same service, even if the cost is much higher. If they take a risk and it succeeds, the most they may get is a favorable mention in a trade magazine. If it fails, they may lose their jobs. Fortunately, there are risk sharing mechanisms or organizations for local governments in several states (Florida, Virginia, California, etc.) that may help in the introduction and demonstration of new systems and technologies.

### **Inapplicable or obsolete government regulations**

Many government regulations are based on the assumption that there will be little change in design or technology. The details are usually based on traditional products with some allowance for incremental improvements. But major changes; going from liquid to a gaseous fuels, or cars with significantly different dimensions, may not meet the letter of the regulations—even when they meet the spirit.

Serious barriers may be encountered when regulations intended for buildings are applied to ve-

hicles. These regulations may be hard to discover, for example, New York City Fire Department rules forbid filling containers with propane within the city limits. Some other illustrations: When Burlington Northern was developing a natural gas (liquefied methane) locomotive it found that regulations required that there must be several cars between the locomotive and a natural gas tank car. I was told that during the first tests the natural gas was stored on a flat car on a parallel track. The father of a California transportation planner was amused and frustrated, in the late 1960's, when he attempted to drive his new front wheel drive Olds Toronado over a snow bound mountain pass. He was stopped by the police and required to move the chains from the front to the rear wheels because that is where the regulations said they should be.

It may take longer to get revisions to regulations agreed to and approved than to design a new vehicle and get it into production. The process of negotiations with regulators should start as soon as there is a technical base or a design concept that can be used by the regulators to determine how to modify regulations to meet the needs of the new technologies and still meet the intent of the underlying legislation.

### **Compliance with safety and energy and environmental regulations**

The increasingly complex environmental, safety and similar regulations impact the development of new technologies and concepts at four levels:

- The ability to conduct meaningful research and testing
- The ability to develop manufacturing capacity
- The operation of the concept
- The disposal of the exhausted product

Environmental approvals will be required before construction can start, or major modifications made, on facilities for the manufacturing the new products. These approvals can seldom be obtained in less than a year. Before a product can be sold it must meet all established safety standards. The manufacturer must demonstrate compliance with

the then existing energy and environmental standards. The process of demonstrating that they meet these requirements can take a year or more depending on the magnitude of the changes.

Major new infrastructure construction such as freeways or pipelines will require environmental reviews that may seriously delay or even prevent their construction. The Federal Highway administration estimates that it will take at least a year and a half to get the permits to build a new highway or transit line if there are no objections. Realistically it would be unlikely that construction of a new facility could be started in less than three to four years after the first request was formally made.

Energy researchers have indicated that environmental and occupational safety regulations may make it difficult or impossible to use certain chemicals and test processes that are necessary to evaluate new fuels. The research may have to be conducted overseas.

Safety regulations and liability concerns make it difficult to test a product to the limit, that is, to failure such as a rollover, or to test of safety equipment beyond the established regulations. Yet the designer cannot be comfortable with what he has designed until it is tested to the limit.

### **Product liability**

I know that product liability is a controversial topic, but I have found that it is a major psychological barrier to new product development and sale. It is impossible to design a product that is absolutely safe—any new product will encounter problems and misuse that could not logically have been anticipated in advance.

I have been working for nearly fifteen years to demonstrate the benefits of a non-conventional personal vehicle, which will deliver over 120 miles per gallon with conventional technologies, can have all the amenities of a conventional car, and is more maneuverable than most cars. The barrier to its commercialization has been the concern that it is different. It should have fewer accidents, but they will be different. A single major claim could wipe out all anticipated profits on the product.

Industry is reluctant to introduce any new technology until there is adequate operating and accident history for the insurance companies to de-

velop a rate structure. This experience may have to be obtained in a nation with a less litigious climate, unless there is some way to indemnify companies that introduce societally beneficial technologies. One state has offered such protection for a product they found particularly attractive.

The U.S. has a tradition of encouraging innovation, and protecting entrepreneurs from competition at least until patent protection runs out. Similar, limited, protection from liability suits would make it possible for companies to justify introducing significantly different products.

### **CONCLUSIONS**

It should be possible to resolve most of the non-technical barriers within the time it will take for the effective development of an all electric, fuel cell, or hybrid car. The White House sponsored, "Next Generation Car" initiative should address some of the barriers and provide the mechanism for sponsoring strategies to overcome the delays they may create.

There are both societal and economic incentives for accelerating the development of the "new generation" of cars and light vehicles. It will provide the opportunity to allay the public concern over the future environment and energy availability. Undoubtedly, many new and apparently viable concepts will be developed, but only a few will pass the test of the market. Parallel development programs during the high risk phases can serve as a "fly off" to determine which have the best chance of being commercialized or if more than one approach will be required for different applications.

I know it is not traditional, or easily accomplished, but I think that all principal investigators, at any stage after proof of technical feasibility, should study the commercialization process and identify those barriers which apply to a specific technology or vehicle concept. Sponsors should have a mental picture of how they might be approached. The relatively limited resources in the country and industry make it important to avoid waste of efforts on second best, or dead ended concepts, and to use existing resources as effectively as possible to accelerate the development of new competitive technologies for their energy, economic, and societal benefits.

## REFERENCES

- [1] Study of strategies for production of niche vehicles by the Michigan Industrial Technology Institute.
- [2] N. McQueen and A. Sobey, "Simulation of stability and control of automobiles," GM Design Staff, 1965.
- [3] "Competitive Survival, Private Initiatives, Public Policy and the North American Automotive Industry," The Office for the Study of Automotive Transportation, The University of Michigan, Transportation Research Institute, June, 1992.

## SESSION REPORT: ENERGY STORAGE SYSTEMS

C. Christianson and G. L. Henriksen  
Electrochemical Technology Program, Argonne National Laboratory  
Argonne, IL 60439

### SESSION ATTENDANCE

The session on Energy Storage Systems was attended by 50 people who represented a broad range of component developers and manufacturers, potential sponsors, EV and HEV manufacturers, EV and HEV users, and other interested parties.

### BACKGROUND INFORMATION

The "strawman" view-graphs, which were used to conduct the session, are presented in Appendix A. The view-graphs cover the following topics:

- Session Discussion Areas
- Session Objectives
- Performance Specifications and Requirements for EVs
- Technical, Economic, and Commercial Issues
- Status of EV Battery Development and R&D Requirements
- Market-driven Commercialization Schedule
- Standards and Test Procedure Requirements
- Session Discussion Approach

### ENERGY STORAGE SYSTEM REQUIREMENTS

The mid- and long-term criteria, developed by the USABC, were used as requirements for EV energy storage systems. The USABC primary and secondary criteria are included as part of Appendix A. A more difficult challenge was to establish some reasonable requirements for HEV energy storage systems, based on the fact that

there are a very large number of HEV alternatives. Fortunately, Larry Oswald, Manager GM HEV Program, was willing to provide information on the energy storage requirements GM is seeking to achieve for their two primary HEV options: 1) a dual-mode HEV and 2) a power-assist HEV. These requirements are provided in Appendix B.

### ENERGY STORAGE TECHNOLOGIES

The approach used in conducting the Energy Storage System Session was to identify EV and HEV energy storage technologies of interest to the group, select a subgroup of technologies for further consideration at the workshop, and develop information on these technologies for use in guiding future R&D for EV and HEV energy storage systems. Batteries, ultracapacitors, and flywheels were identified as technologies for consideration. Seventeen different battery technologies were identified. Information on these energy storage technologies was obtained in the areas of R&D sponsors, developers, and current status. This information is provided in Appendix C.

Due to time limitations, it was necessary to reduce the number of energy storage systems considered during the workshop. For this reason, it was decided that the EV battery technologies being developed under the sponsorship of the US-ABC would not be considered as part of this workshop. Brief presentations were given by several attendees, and the materials presented are included in these proceedings immediately following this report [1-6]. These materials include information on ultracapacitors, flywheels, and several types of batteries (Zn/air, "quasi-bipolar" Pb/acid, common-vessel Ni/Cd, and Li-ion).

## SESSION RESULTS

The primary results of the session were summarized during the session wrap-up presentation using two view-graphs, which are provided in Appendix D.

Subsequent to the workshop, a preliminary analysis of alternative energy storage systems was performed. The results are summarized in Appendix E. The system energy versus power matrix helps to categorize the current and potential capabilities of the energy storage systems identified at the workshop. The projected commercial availability table identifies the technologies that are available today (or within the next year) and provides estimates for the other technologies regarding pre-2000 or post-2000 availability, based on the implementation of an aggressive development program in all cases.

## REFERENCES

- [1] E. Dowgiallo, "The DOE Ultracapacitor Program," these proceedings pp. 131-143.
- [2] H. Saunders, "Westinghouse Zinc/Air Battery Development for Electric Vehicle Applications," these proceedings pp. 144-145.
- [3] J. Lushetsky, "Quasi Bipolar Lead-acid Battery (Woven Lead Composite Grid)," these proceedings p. 146.
- [4] A. Nilsson, these proceedings pp. 147-153.
- [5] R. Post, "Flywheel Technology," these proceedings pp. 154-155.
- [6] R. Koopman and J. Richardson, "Promising Future Energy Storage Systems: Nanomaterial Based Systems, Zn/Air and Electromechanical Batteries," these proceedings pp. 156-163.

---

**APPENDIX A: SELECTED "STRAWMAN" VIEW-GRAPHS****SESSION DISCUSSION AREAS**

1. Session Objectives
2. Performance Specifications
3. Current Technical, Economic, and Commercial Barriers
4. Potential Technical Solutions and Opportunities for Development
5. Requirements and Developments Needed for Improved Manufacturing
6. Schedule/Timetable for EV and HEV Component Development
7. Requirements of Future Standards and Test Procedures

**Figure 1.****SESSION OBJECTIVES**

- Identify energy storage needs for EVs and HEVs
- Identify energy storage components and subsystems processing potential to meet needs, e.g.:
  - Batteries
  - Flywheels
  - Ultracapacitors
  - Hydraulic pressure accumulators
  - Elastomers
- Investigate development barriers and identify R&D needed to overcome barriers
- Contrast projected R&D program schedules with projected timing of EV and HEV market penetration

**Figure 2.**

PERFORMANCE SPECIFICATIONS

- Discharge peak power density
  - Volumetric
  - Gravimetric
- Charge peak power density
  - Volumetric
  - Gravimetric
- Energy density
  - Volumetric
  - Gravimetric
- Operational life
  - Calendar
  - Cycle
- Abuse tolerance
  - Electrical
  - Mechanical
  - Thermal
- Safety
  - Driver and passengers
  - Pedestrians
- Cost and manufacturability

Figure 3.

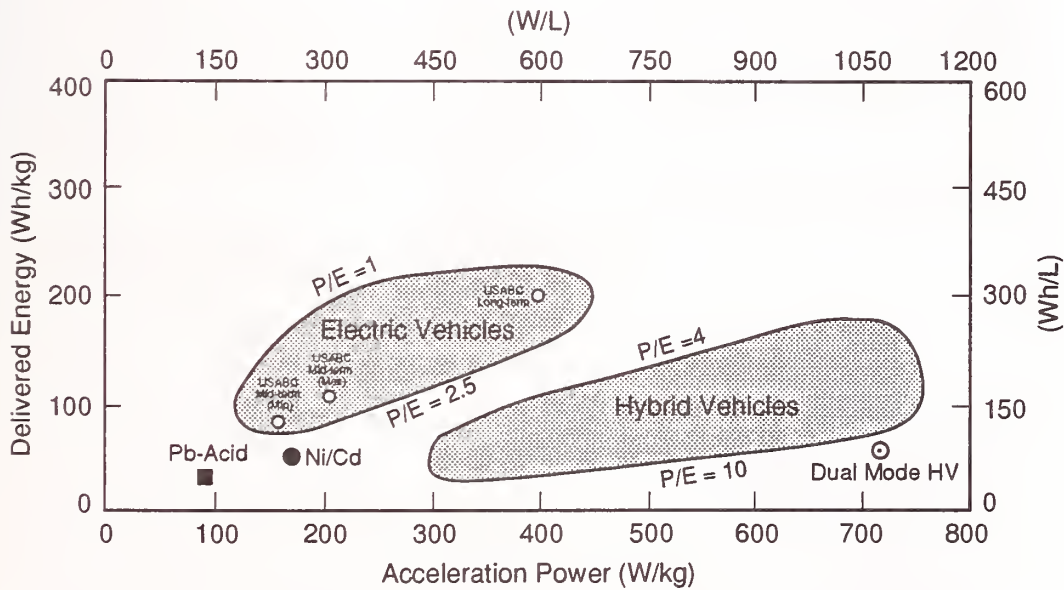

Figure 4. Desired EV and HEV energy storage system performance characteristics.

**Table 1.** USABC primary criteria for electric vehicles

Criteria	Mid-term	Long-term
Power Density, W/L	250	600
Specific Power, W/kg (30 s @ 80% DOD)	150 (200 desired)	400
Energy Density, W·h/L (@ C/3 Rate)	135	300
Specific Energy, W·h/kg (@ C/3 Rate)	80 (100 desired)	200
Life, years	5	10
Cycle Life, cycles (@ 80% DOD)	600	1000
Power/Capacity Degradation, %	20	20
Price, \$/kW·h (10k units/yr)	<150	<100
Operating Environment, °C	-30 to 65	-40 to 85
Recharge Time, h	<6	3 to 6
C/1 Capacity, % of rated	75	75

**Table 2.** USABC secondary criteria for electric vehicles

Criteria	Mid-term	Long-term
Efficiency, % (@ C/3 discharge and C/6 charge)	75	80
Self-discharge, %	15 in 48 h	15 per month
Maintenance	None	None
Thermal loss, W/kW·h (for high-temperature batteries)	3.2 (15% capacity in 48 h)	3.2 (15% capacity in 48 h)
Abuse Resistance	Tolerant (Minimized by on-board controls)	Tolerant (Minimized by on-board controls)

**OTHER REQUIREMENTS**

- Packaging Constraints
- Environmental Impact
- Safety
- Recyclability
- Reliability
- Overcharge/Overdischarge Tolerance



### COMMERCIAL ISSUES

- Infrastructure Investment
- Battery Disposal and Recycling
- Manufacturing ES&H
- Shipping

Figure 5.

Table 3. ANL data on existing EV batteries

Parameter	Lead-acid	Ni/Cd	USABC Mid-term Criteria
Peak Power, W/kg	91	175	150
Energy <sup>a</sup> , W·h/kg	36	55	80
W·h/L	92	104	135
Calendar Life, years	?	TBD <sup>c</sup>	5
Cycle Life <sup>b</sup> , cycles	370	1018	600
Price, \$/kW·h	TBD <sup>c</sup>	TBD <sup>c</sup>	<150
Commercial Issues	Recycling Pb	Recycling Cd	

<sup>a</sup> Determined for C/3 discharges

<sup>b</sup> Determined under J227aC discharges

<sup>c</sup> TBD (to be determined)

Table 4. Battery development and manufacturing opportunities

Battery Technology	EV P/E<4.0	HEV P/E=4.0-6.0	HEV P/E>6.0	Major Issues
Pb-Acid	Prismatic Available	Under Development in Higher-Power Designs	Under Development as Bipolar Battery	Limited Energy Pb Recycling Cycle Life
Ni/Cd	Prismatic Available	Low Difficulty as Advanced Design	?	Cost, Cd Recycling
Ni/MH	USABC Project	Low Difficulty as Advanced Design	?	Cost,
Na-Beta	Commercial Development	Medium-to-High Difficulty	Bipolar possible with Na/NiCl <sub>2</sub>	Cost Limited Power, Calendar Life
Li-Polymer	USABC Project	Medium Difficulty	?	Cost Limited Power, Life
Li-Al/FeS <sub>2</sub>	USABC Project (as Bipolar Battery)	Under Development as Bipolar Battery	Under Development as Bipolar Battery	Cost/Life

**Table 5.** Current technical, economic, and commercial barriers

Energy Storage Device	Technical Barriers	Economic Barriers	Commercial Barriers
Batteries	Power/Energy, Life	Price	TBD
Flywheels	TBD	TBD	TBD
Ultracapacitors	TBD	TBD	TBD
H-P Accumulators	TBD	TBD	TBD
Elastomers	TBD	TBD	TBD

### POTENTIAL TECHNICAL SOLUTIONS AND OPPORTUNITIES FOR DEVELOPMENT

- Batteries
  - Bipolar batteries for high P/E
  - Stable materials and abuse tolerant battery technologies to increase life
  - Cost effective materials and processes to reduce cost
- Flywheels: TBD
- Ultracapacitors: TBD
- Hydraulic pressure accumulators: TBD
- Elastomers: TBD

**Figure 6.****Table 6.** Schedule/timetable for EV and HEV component development

Market-Driven Schedule			
Battery Type	Engineering Prototype	Pilot-scale Production	Commercial Production
Mid-term EV Batteries	Available Today	Available in 1994-95	Available in 1998
Long-term EV Batteries	Available in 1994-95	Available in 1999-2000	Available in 2003
Improved HEV Batteries	TBD	TBD	TBD

## REQUIREMENTS OF FUTURE STANDARDS AND TEST PROCEDURES

### EV Battery Test Procedures (per DOE/USABC)

- Constant Current Tests: C/3, C/2, C/1, and C/3 (baseline capacity)
- Constant Sustained Power Tests at Several Power Levels
- Dynamic Power Tests: FUDS, SFUDS, UFUDS, DST, etc.
- Peak Power Tests at Various Depths of Discharge (DOD)
- Special Tests:
  - Stand test to measure self-discharge rates
  - Hill climb tests
  - Thermal limit tests
  - Abuse tests: e.g. overcharge/overdischarge tests
  - Vibration tests
  - Partial DOD tests
  - Rapid recharge tests
  - Freeze/thaw tests (for high temperature batteries)
- Life Cycle Testing using Dynamic Power Test Regime

**Note:** Tests of this type will be applicable for overall HEV power systems

Figure 7.

**SESSION DISCUSSION APPROACH**

- Identify Energy Storage Technologies of Interest to the Group
- Establish Area of Application for Each Energy Storage Technology
  - Plot Performance on W·h/kg versus W/kg Map
    - Present
    - Projected
  - Identify Major Limitations (Show Stoppers)  
e.g. Life, Cost, Etc.
- Select Energy Storage Technologies for Further Consideration by Group
- For Each Selected Technology, Identify
  - Major Barriers
    - Technical
    - Economic
    - Commercial
  - Potential Solutions, R&D Needed and Timetable
    - Technical
    - Manufacturing
    - Other
  - Areas With Adequate R&D Presently Underway
  - Areas Where R&D Should be Initiated or Expanded
- Identify Future Standards and Test Procedure Requirements
  - Electric Vehicles
  - Hybrid Vehicles

**Figure 8.**

## APPENDIX B: ENERGY STORAGE REQUIREMENTS FOR DUAL-MODE AND POWER-ASSIST HEVs

### DUAL-MODE HEV ENERGY STORAGE REQUIREMENTS

Goals:

- Improve Fuel Economy by 50–100%
- Reduce Emissions to <ULEV levels

Requirements:

<b>Energy</b>	6–8 kW·h	44–59 W·h/kg
<b>Power</b>	100 kW	733 W/kg
<b>Cost</b>	<\$800	<133 \$/kW·h <8 \$/kW
<b>Weight</b>	<300 lb (136 kg)	
<b>Cycle Life</b>	>2,000	

### POWER-ASSIST HEV ENERGY STORAGE REQUIREMENTS

Goal: Improve Fuel Economy by 30–50%

Requirements:

<b>Energy</b>	0.5–2 W·h	22–88 W·h/kg
<b>Power</b>	50–70 kW	2.2–3.1 kW/kg
<b>Cost</b>	<\$300–500	<600–250 \$/kW·h <6–7 \$/kW
<b>Weight</b>	<50 lb (23 kg)	
<b>Cycle Life</b>	100,000	

Figure 9.

**APPENDIX C: INFORMATION COLLECTED ON ALTERNATIVE ENERGY STORAGE SYSTEMS**

**Table 7. Energy storage technologies identified**

<b>Technology</b>	<b>R&amp;D Sponsors</b>	<b>Developers</b>	<b>Status</b>
<b>Ultracapacitors</b>	DOE	Maxwell/Auburn LLNL Pinnacle SNL LANL SRI Federal Fabrics	Laboratory Prototype
<b>Flywheels</b>	LLNL ARPA NASA DOE	LLNL ORNL Rockwell US Flywheel American Flywheel Honeywell  SATGOM U. of Maryland	Laboratory Prototype      Vehicle Demo
<b>Batteries</b>			
<b>Ni/MH</b>	USABC/DOE	Ovonics SAFT EPI Maxcell	Full-Scale EV Battery
<b>Na-Beta</b>	USABC/DOE DOD	Silent Power ABB AEG Hughes EPI ANL	Pilot Production

Table 8. Energy storage technologies identified (cont.)

Technology	R&D Sponsors	Developers	Status
<b>Batteries (cont.)</b>			
Li/MS	USABC/DOE DOD	ANL SAFT Westinghouse EPI Electrofuel	Laboratory prototype
Li-Polymer	USABC/DOE DOD	W. R. Grace Valance/Delco Hydro-Quebec Penn State Univ.	Laboratory Prototype
Al/Air	ARPA ALCAN	Alupower Eltech	8 kW-h as Mechanically Rechargeable
<b>Pb-Acid</b>			
- Bipolar	CARB SCAQMD DOD EPRI	Arias Pinnacle Battelle	EV Prototype
- Prismatic	—	Delco et al.	Production
- Woven-grid	EPRI	BDM/Electrosorce	Pilot Production in January 1994
<b>Li-Ion</b>	DOE DOD	LLNL	Laboratory Prototype
<b>Ni/Cd</b>			
- Prismatic	—	SAFT EPI ERC ACME	Production
- Common Vessel	—	ACME Electric	Laboratory Prototype

Table 9. Energy storage technologies identified (cont.)

Technology	R&D Sponsors	Developers	Status
<b>Batteries (cont.)</b>			
Ni/H <sub>2</sub>	—	JCI EPI	Production
Ni/Fe	EPRI (?)	EPI	Prototype Production
Na-Polymer	DOE	LBL	Research
Zn/Air	DOE ILZRO LLNL AZ Public Service So. Cal. Edison	Westinghouse LLNL DEMI MATSI SRI Electric Fuel	Laboratory-to-EV Prototypes
Zn/Br <sub>2</sub>		Powercell SEA	Preproduction



---

**APPENDIX D: RESULTS OF ENERGY STORAGE SYSTEM SESSION****Ultracapacitors**

- Promising Technology for HEVs
- Key Barriers
  - Cost
  - Energy Density
- Higher Funding Level Desirable

**Flywheels**

- Promising Technology for HEVs
- Key Barriers
  - Bearings
  - Vehicle Environment
- Higher Funding Level Desirable—Included in DOE HEV Program

**Batteries**

- EV Batteries Funded by USABC
  - Ni/MH
  - Na/S
  - Li/MS
  - Li-Polymer
- Zinc/Air
  - High Energy Density
  - Low Cost
  - Key Barriers
    - Power Density
    - Life
  - Funding Support by Several Organizations Including DOE
- Lead-Acid and Nickel/Cadmium
  - Commercially Available
  - Product Improvements Underway

**Test Procedures**

- EV Systems—USABC/DOE Procedures Available
- HEV Systems—Procedures Needed

**Pilot Production**

- Process Development Support Needed

## APPENDIX E: ANALYSIS OF ENERGY STORAGE SYSTEMS

Table 10. System energy versus power

Energy density (W·h/kg)	Acceleration power density (W/kg)		
	<300	300-1000	>1000
<75	Pb-Acid Ni/Cd Ni/Fe Ni/H <sub>2</sub>	Conventional Flywheels Bipolar Pb-acid	Ultracapacitors
75-150	Ni/MH Na-Beta Zn/air Zn/Br <sub>2</sub>		Advanced Flywheels Bipolar Li/MS
>150	Li-Polymer Li-ion Na-polymer	Bipolar Li/MS	

Table 11. Projected commercial availability of energy storage systems

Energy storage system	Projected commercial availability		
	Now	Before 2000	After 2000
Batteries	Pb-Acid <ul style="list-style-type: none"> <li>• Prismatic</li> <li>• Woven-grid</li> </ul> Ni/Cd <ul style="list-style-type: none"> <li>• Prismatic</li> <li>• Common Vessel</li> </ul> Ni/Fe Ni/H <sub>2</sub>	Na-Beta Ni/MH Pb-Acid (bipolar) Zn/Air Zn/Br <sub>2</sub>	Li/MS Li-Polymer Li-Ion Na-Polymer
Flywheels		1 <sup>st</sup> Generation	Advanced
Ultracapacitors		1 <sup>st</sup> Generation	Advanced

## THE DOE ULTRACAPACITOR PROGRAM

E. Dowgiallo  
US Department of Energy  
Washington, DC 20585

### ABSTRACT

Programs sponsored by the US Department of Energy for development of ultracapacitors are reviewed. The specific application of ultracapacitors to electric vehicles is discussed.

## ULTRACAPACITOR DEVELOPMENT

**Table 1.** Near-term and advanced goals for the DOE ultracapacitor development programs

<b>Battery without Capacitor</b>	<b>Near-term</b>	<b>Advanced</b>
Weight (kg)	500-600	200-300
Power density (W/kg)		
Average	10	20
Gradeability	30-50	110-160
Peak (acceleration)	80	375-550
<b>Ultracapacitor Unit</b>		
Energy stored (W·h)	500	750
Maximum power (kW)	50	80
Weight (kg)	<100	<50
Volume (l)	<40	<20
Energy density (W·h/kg)	>5	>15
Maximum usable power density (W/kg)	>500	>1600
Round trip efficiency (%)	>90	>90
<b>Vehicle Acceleration</b>		
0 to 88 km/h (s)	<20	<8

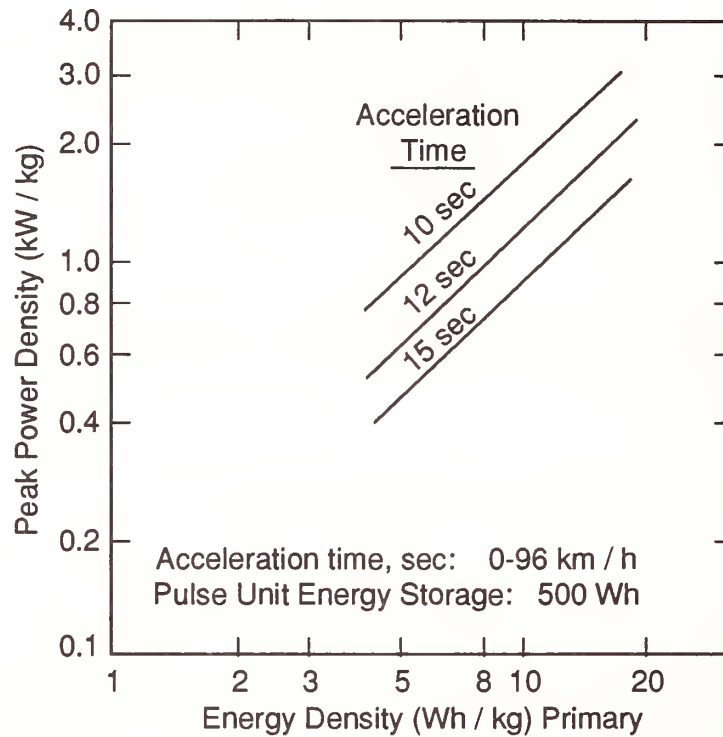

Figure 1. Peak power density requirement for a pulse-power unit in a compact car.

The U.S. Department of Energy (DOE)  
 Ultracapacitor Program

Technologies

- Carbon/metal fiber composites — Maxwell/Auburn
- Monolith foamed carbon — Livermore National Laboratory
- Foamed carbon with a binder — Sandia National Laboratory
- Doped polymer layers on carbon paper — Los Alamos National Laboratory
- Mixed metal oxides (ceramic) on metal foil — Pinnacle Research Institute

Figure 2.

Table 2. Status of ultracapacitor technologies

Technology	Developer	First Deliverables		
		Date	Description	W-h/kg
Composite carbon fiber	Maxwell/Auburn	7/93	carbon/nickel, aqueous cells, 20 cm <sup>2</sup>	1.5-2.0
Aerogel carbon	Lawrence Livermore National Laboratory	10/93	aerogel carbon, aqueous cells, 80 cm <sup>2</sup>	3-4
Mixed-oxide (ceramic)	Pinnacle Research	11/93	mixed-oxide, aqueous 8 V stack, 80 cm <sup>2</sup>	5
Foamed carbon particulate with binder	Sandia National Laboratory	11/93	foamed carbon with binder, aqueous 1 V cells	2-3
Doped polymer on carbon paper	Los Alamos National Laboratory	1/94	doped polymer organic (type I) 1 V cell	4-5
Z-axis carbon	Federal Fabrics	3/94	z-axis carbon, aqueous 20 cm <sup>2</sup> 1 V cells	6-8
Nanostructure multilayer	Lawrence Livermore National Laboratory	2/94	single film TiO <sub>2</sub> 1 μm, 400 V, 50 cm <sup>2</sup> , very low loss (<0.1%)	2-3*
Lithium polymer pulse battery	Stanford Research Institute	4/94	1.7 V, single cell, 7 μm tape, high power (>50 kW/kg)	50-70

\*Potential for significant weight/volume reduction if integral to structure.

Table 3. Status of ultracapacitor technologies with projections

Technology	Developer	Near-term Deliverables			Projected W-h/kg
		W-h/kg	Date	Description	
Composite carbon fiber	Maxwell/Auburn	1.5-2.0	10/93	carbon/nickel aqueous 20 V cells 20 cm <sup>2</sup>	3-4
Aerogel carbon	Lawrence Livermore National Laboratory	8-10	10/93	carbon/alum/organic cells, 20 cm <sup>2</sup>	10-12
Mixed-oxide (ceramic)	Pinnacle Research	5	4/94	aerogel carbon organic cells, 80 cm <sup>2</sup> mixed-oxide, aqueous 32 and 100 V stacks, 80 cm <sup>2</sup>	5
Foamed carbon particulate with binder	Sandia National Laboratory	7.5	9/94	mixed-oxide aqueous, 8 V stack	10
Doped polymer on carbon paper	Los Alamos National Laboratory	10-15	8/94	enhanced foamed carbon with binder doped polymer organic (type III), 3 V cell	15
Z-axis carbon	Federal Fabrics	8-10	6/94	z-axis carbon, aqueous 20 cm <sup>2</sup> , 20 V cells	10
Nanostructure multilayer*	Lawrence Livermore National Laboratory	2-3**	6/94	z-axis carbon, aqueous 20 cm <sup>2</sup> , 50 V bipolar multilayer film TiO <sub>2</sub> 1 μm, 400 V, 50 cm <sup>2</sup> , very low loss (<0.1%)	3**
Lithium polymer pulse battery*	Stanford Research Institute	50-70	10/94	50 V, bipolar tape, 7 μm tape, very high power	70

\*Pending approval of funding for these technologies.

\*\*Potential for significant weight/volume reduction if integral to structure

**Panasonic 3 V, 1500 F Capacitors**

• Technology	Single cell, spiral wound, carbon-based, organic electrolyte
• Size	Diameter 7.7 cm Length 14.9 cm Volume 693 cm <sup>3</sup>
• Weight	887 gm
• Energy stored (charging 100 A, 0 to 3 V)	2.667 W·h (3.0 W·h/kg; 3.85 W·h/l)
• Energy Discharged (100 A, 3 V to 1 V)	1.89 W·h (2.13 W·h/kg; 2.73 W·h/l)
• Resistance	1.2 milliohms
• Maximum power* (3 V → 1.5 V)	2.1 kW/kg

\*to a matched load

**Figure 3.**

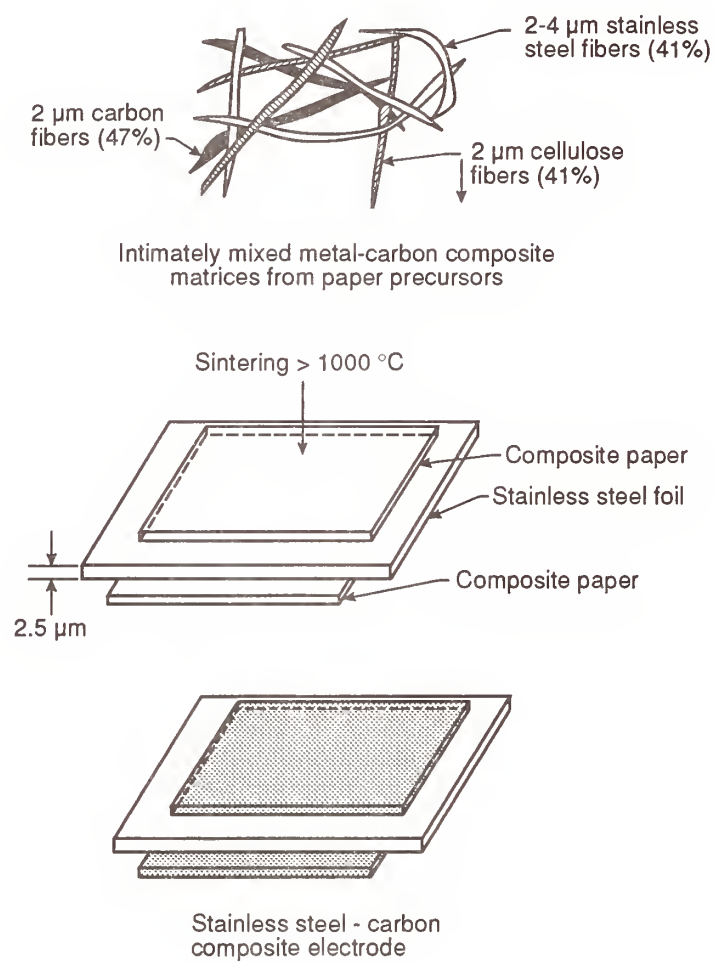

**Figure 4.** Carbon/metal fiber electrode structure.



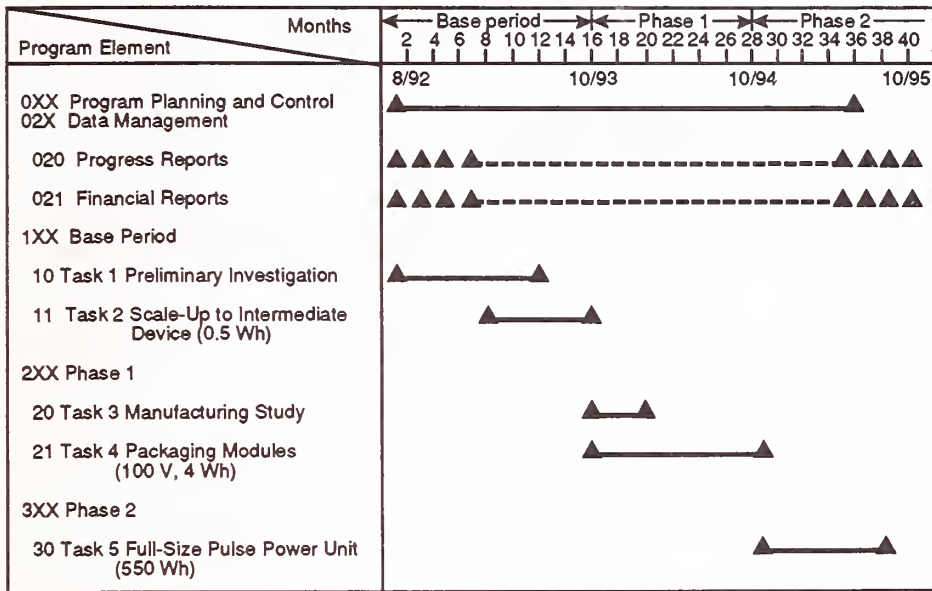

Figure 5. Milestone chart for the development of ultracapacitor technology electric vehicle applications.

**Maxwell/Auburn 1 V, 75 F Capacitor**  
(as of August 1993)

- Technology: Single cell, 20 cm<sup>2</sup> disk, composite carbon-metal fibers, aqueous (KOH) electrolyte
  - Size: Diameter 5 cm, Thickness 0.187 cm, Volume 3.77 cm<sup>3</sup>
  - Weight: 6 gm
  - Energy Stored/Discharged (1 A, 0 → 3 V): 39 W/s (1.8 W·h/kg, 2.9 W·h/l)
  - Resistance: 10 milliohms
  - Maximum Power\* (1 V to .5 V): 4.2 kW/kg
- \* to a matched load

Figure 6.

**Maxwell/Auburn 3 V, 27 F Capacitor**  
(as of August 1993)

- **Technology** Single cell, 20 cm<sup>2</sup> disk, composite carbon-metal fibers, organic electrolyte
- **Size** Diameter 5 cm, Thickness 0.15 cm, Volume 3 cm<sup>3</sup>
- **Weight** 4.5 gm
- **Energy Stored/Discharged** 121 W/s  
(1 A, 0 → 3 V) (7.5 W·h/kg, 11.2 W·h/l)
- **Resistance** 0.15 ohm
- **Maximum Power\*** 3.3 kW/kg  
(3 V to 1.5 V)
- to a matched load

**Figure 7.**

**Conclusions**

- Power capacitors are available commercially from Panasonic for laboratory tests.
- Good progress is being made in the U.S. DOE Program to develop capacitors with energy density of 5 to 10 W·h/kg.
- Ultracapacitors are likely to be key components in the drive lines of high-performance hybrid-electric vehicles.

**Figure 8.**

## NANOSTRUCTURE MULTILAYER CAPACITORS

Proposed nanostructure multilayer capacitor (NMC) development plans target short term proof-of-principal with research activities through May.

### Objectives

- Development of NMC fabrication processes
- Research of dielectrics
- Characterization of metal metal-oxide systems
- Design of high performance NMCs
- Fabrication and test of proof-of-principal NMCs
- Scale-up to large area NMCs
- Develop high volume deposition for production
- Technology transfer to industry

**Figure 9.**

### Deliverables

At first Milestone...

- Single film nanostructure capacitors
- Report on process development, dielectric conductor materials, capacitor performance, projected performance of NMCs

At second Milestone...

- Small scale (50–60 cm<sup>2</sup>) NMCs
- Report on NMC fabrication and characterization, projected performance of large scale NMCs

**Figure 10.**

**Milestones** (With 1st funding available November 1)February 15, 1994

- Dielectric-conductor materials characterized
- Deposition process proven
- Caps with target performance fabricated and characterized

June 1, 1994

- Proof-of-principal NMCs fabricated and tested
- NMC masking and fabrication process developed
- NMC specified and designed for EV application
- Develop follow-on NMC development plan

**Figure 11.****What's possible with nanostructure multilayers?**

Stoichiometric amorphous nanostructure (down to 2 microns)

Multilayers

- Conductors
- Materials with high permittivity/dielectric constant
- Materials with high dielectric breakdown voltage
- Materials with complementary dielectric thermal coefficient
- Materials with low loss tangents

Structures as thin as atomic monolayers ( $\sim 10 \text{ \AA}$ ) built up to devices  
up to devices  $300 \text{ cm}^2 \times 2 \text{ mm}$

**Figure 12.****Why are sub-micron multilayers of interest?**

They represent a new state of matter not previously available.

They are engineered materials fabricated to the desired application and performance.

They enable new technology approaches to important problems.

**Figure 13.**

**Strengths**

Rugged solid-state construction.

Ability to engineer dielectric performance.

Projected very high energy and power density.

Flat profile attractive for:

- Embedded load leveling capacitors for electric and hybrid vehicles
- Power transmission bus to drive motors
- Distributed power management capacitance

Can be integrated with IGBTs and power electronics.

Can be an integral part of battery packaging.

Figure 14.

**Why do we care about capacitors?**

Components are crucial to the electronics industry

- Capacitors are a \$6 B worldwide market
- U.S. share is only 8 percent
- They are a high-volume commodity item

New capability can enable new worldwide markets

- Power electronics; short term energy storage
- Crucial to electric and hybrid vehicle power management applications
- Important in computers and consumer electronics

Figure 15.

**Weaknesses**

Solid-state construction of NMCs has a weight penalty.

Can't take full advantage of high-voltage capability and very high energy density in electric and hybrid vehicle applications.

$$W = \frac{1}{2}CV^2 \quad (1)$$

New program; new untried technology for capacitors.

Research needs to be done on dielectrics and deposition process.

New, high volume deposition process needs development to drive production costs down.

Figure 16.

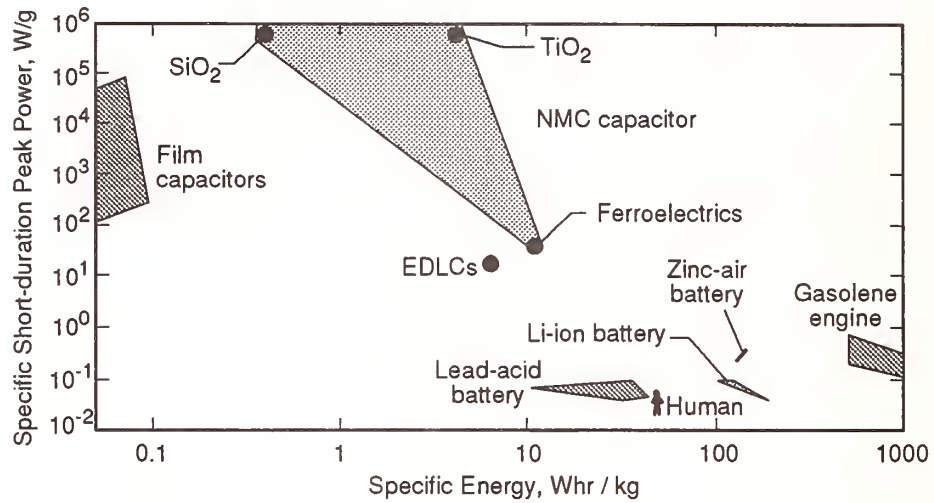

Areocapacitor: measured performance as of 5-12-93 (S. Mayer, LLNL).

Nanostructure multilayer capacitor (NMC): predicted performance for various dielectrics (G. Johnson, LLNL).

Film capacitors: typical performance of high-energy discharge capacitors.

Lithium battery: measurements and specifications from Sony Corp.

Lead-acid battery: from DOE Electric and Hybrid Vehicles Program, Report DOE/CD-0357, 5-92.

Human: professional bicyclist, 68 kg, 150 miles in 5 hours (0.9 HP average) 2 HP peak.

**Figure 17.** NMCs with various dielectrics are projected to have very high specific-power and competitive specific energy.

**High volume NMC production for EVs becomes cost-effective as alternative deposition techniques are developed.**

For an annual production target of 10,000 ea. 500 W-h capacitor banks...

190 NMC deposition reactors (as used in research) can meet annual production @ \$2,000/unit.

6 High deposition rate machines can produce the 10,000 capacitor banks annually @ \$1,300/unit.

Capacitor Bank Specifications

Energy	500 W·h, 1.8 MJ
Weight	19.5 Kg
Volume	3540 cc, flat profile or bulk
Number of individual NMCs	59/500 W-h bank

NMC Specifications

Capacitance	0.38 F
Voltage	400 V
Dimensions	200×300×1 mm

NMC production

	<u>Research deposition rates</u>	<u>High volume deposition</u>
Deposition rate	10.0E - 06 mm/s	5.8E - 03 mm/s
NMC daily production	12.4/day	425/day
NMC annual production	3,100 NMCs/year	106,000 NMCs/year

NMC production costs

Labor costs	\$17/NMC	\$5/NMC
Expendables and materials	\$17/NMC	\$17/NMC
Capitalization	\$1,700 K/chamber	\$2,000 K/chamber

Cost summary

500 W-h capacitor bank cost (with 2 year capital investment pay back)	\$17,200/EV	\$1,850/EV
500 W-h capacitor bank cost (after amortization, COGs and labor only)	<span style="border: 1px solid black; padding: 2px;">\$2,010/EV</span>	<span style="border: 1px solid black; padding: 2px;">\$1,300/EV</span>

**Figure 18.**

**WESTINGHOUSE ZINC-AIR BATTERY DEVELOPMENT FOR ELECTRIC  
VEHICLE APPLICATIONS**

H. E. Saunders  
Westinghouse Electric Corporation  
Science & Technology Center  
Pittsburgh, PA 15235

**ABSTRACT**

Development of a zinc-air battery for application to electric vehicles, which was performed under contract to the US Department of Energy (DOE), is described.

**OBJECTIVE**

**TO DEMONSTRATE THAT ZINC-AIR TECHNOLOGY  
WARRANTS FURTHER DEVELOPMENT  
FOR USE IN ELECTRIC VEHICLES**

**Figure 1.**



**ADVANTAGES OF ZINC-AIR**

ZINC-AIR TECHNOLOGY HAS POTENTIAL FOR:

- Very High Specific Energy
- Very Low Cost
- Ambient Temperature Operation
- Safe and Environmentally Benign Use
- Electrical Rechargeability

**Figure 2.**

**SUMMARY**

1. Significant Progress Was Made In Meeting USABC Goals:
  - Converted To Non-Circulating System
  - Improved Practical Energy Density By More Than 200%
  - Improved Power Capability By 25-40%
2. Progress Indicates That Zinc-Air Warrants Further Development For EV Use
3. Hybrid Systems Will Be Needed To Meet Power Goals
4. Carbon Corrosion Issues Must Be Resolved To Achieve Maintenance-Free Operation

**Figure 3.**

## QUASI BIPOLAR LEAD-ACID BATTERY (WOVEN LEAD COMPOSITE GRID)

J. Lushetsky  
BDM Technologies, Inc.  
McLean, VA 22102

### ABSTRACT

Performance characteristics of a quasi bipolar lead-acid battery that incorporates a woven lead composite grid are presented.

Table 1. Quasi bipolar lead-acid battery characteristics

Specific Energy (C/3 and 90°F)	>50 W·h/kg
Peak Power (from J227aD/IETV-1)	
0% DOD	500 W/kg
80% DOD	300 W/kg
Cycle Life (C/2 to 80% DOD)	900 Cycles to 64% of Original Capacity
Fast Recharge Time (from 80% DOD)	50% in 8 Minutes 99% in 30 Minutes
Cost (in Volume Production)	200 \$/kW·h ~0.03 \$/kilometer*

\*Based on California Air Resources Board baseline, i.e., 1000 lb vehicle battery, 0.24 kW·h/mile, and does not include additional cost of electricity.

## COMMON VESSEL BATTERY TECHNOLOGY

A. Nilsson  
ACME Electric  
Tempe, AZ 85282

### ABSTRACT

The common vessel monoblock (CVM) battery, which has potential for application in future electric vehicles, is described and compared with conventional vented and sealed batteries.

### The Large Battery Challenge

- The operation of a high-capacity, high-voltage battery is not just a linear scale up of a smaller-capacity, lower-voltage battery.
- The EV environment is particularly demanding due to space and weight limitations coupled with heavy duty cycle operation and severe cost restrictions.
- Temperature variations inside large cells and across a string of cells in a large multi-cell battery will diminish charging capability and the life of the battery.
- Robustness to abuse and to single-cell failure is a must.

Figure 1.

### Current Battery Design Options

- Standard Vented Cells:
  - High maintenance + Robust
  - High weight + Low cost
  
- High-Pressure Sealed Cells:
  - Safety issues + No maintenance
  - Cost issues
  - Charge control issues
  - Not robust to abuse
  - Size limitation
  
- Low-Pressure Sealed Cells (Sealed FNC):
  - Matching issues + No maintenance
  - Thermal balance
  - Size limitation
  - Cost implications
  - Limited robustness to abuse
  
- Low-Maintenance Vented Cells (ULM):
  - Plate imbalance problems + More robust than sealed, less than vented
  - Can maintenance be predicted and reduced
  - Cost and safety implications of maintenance

Figure 2.

**New Solution—The Common Vessel Monoblock (CVM)**

Common Vessel Sealed Ni-Cd Battery of Individually Flooded Cells CVM

**Features:**

- Flooded cells strung in series, placed and sealed together in a common multi-cavity vessel with a special gas recombination overcharge buffer cell.
- The gas recombination cell is made out of Cadmium Hydrogen chemistry.
- In stoichiometric overcharge, the recombination cell will recombine oxygen and hydrogen back to water.
- The gas recombination cell can consume oxygen, and consume or evolve hydrogen to keep the common vessel at nominal pressure.
- The system maintains water balance through evaporation.
- The system maintains plate balance over time.
- Fully maintenance-free.

**Figure 3.**

**Key to the New Design**

- A Cd-hydrogen cell that is inside a sealed battery container and shares the gas space with “vented” Ni-Cd cells. The Cd-hydrogen cell thus serves as an *electrochemical pressure regulator*.
- The regulator also serves as a gas analyzer and the battery’s heat dissipater.
- The regulator can consume oxygen only, hydrogen only, or both. This allows for fair overcharge over a wide temperature range without venting, building pressure, or temperature rise in the “working” battery cells.
- The battery is robust against defective cells, and abuse on charge or discharge.
- The principle is also applicable to Ni-Zn, Ni-MHx, and Pb-acid batteries.

**Figure 4.**

**CVM Advantages:**

- An attempt to address the high-voltage, high-capacity, heavy-duty cycle battery at the battery (rather than the cell) level.
- Combines the robustness and lower cost of a vented cell with the advantage of a totally sealed and maintenance-free battery.
- Multi-cavity plastic packaging offers significant cost and weight savings compared with individual metal packaged cells.
- Uses measured overcharge data (pressure, temperature, and voltage) at the battery level and low-cost electronics to optimize the charge profile without venting and without causing plate imbalance.

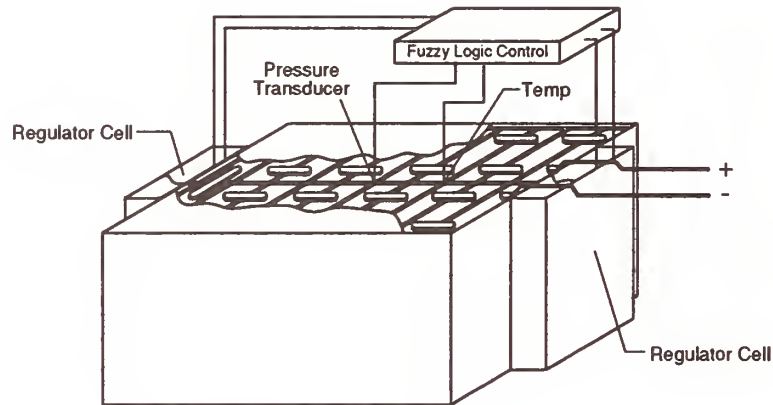
**Figure 5.****Figure 6.** Conceptual design of a 20-cell monoblock battery.**Operation**

- In discharge, the battery operates as a regular vented battery.
- In charge, the battery operates as a regular vented battery until the on-set of gas evolution.
- In overcharge, gas generated at the working cells will be consumed at the regulator.

**Figure 7.**

**Reactions at Regulator:**

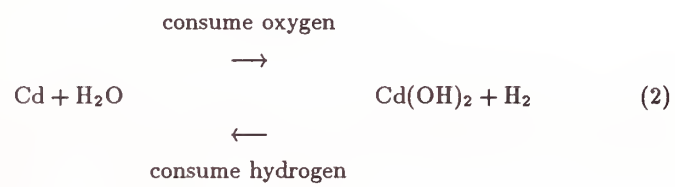
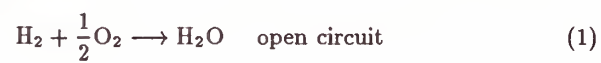

**Figure 8.**

**Table 1.** Comparison of performance characteristics of the common vessel monoblock battery with conventional sealed and vented batteries

	Vented		Sealed		CVM
	Cell	Battery	Cell	Battery	Battery
Specific energy, W·h/kg at C/2	60	45	55	45	60
Practical depth of discharge	100%	80%	100%	70%	90%
Cycle life	>2000	>1500	>2000	>1500*	>2000
Maintenance	yes		none		none
Reverse capability	good		limited		good
Estimated cost, in volume, \$/kW·h		\$300		\$400	\$300

\*with thermal control

**Table 2.** Comparison of commercial, manufacturing, and design features in the common vessel monoblock battery and conventional vented and sealed batteries

	Vented	Sealed	CVM
	Cell Battery	Cell Battery	Battery
Ease of Manufacturing	good	fair	good
Plate imbalance	yes	no	no
Abuse resistance	good	fair	good
State-of-charge Indicator	no	no	yes
Safety	good	good	good



**Summary**

- New concept that will combine the best aspects of vented and sealed Ni-Cd.
- Low risk, all known components, known chemistry, established reliability.
- Experimental data confirms validity of concept.
- Relatively rapid development cycle, all components in production.
- Incorporate fiber electrodes for low weight, low cost, and long life.
- Potential for applications with other battery chemistries.

**Figure 9.**

## FLYWHEEL TECHNOLOGY

R. Post  
Lawrence Livermore National Laboratory  
Livermore, CA 94550

**The electromechanical battery (EMB) has the potential to outperform electrochemical batteries in every important attribute.**

---

- High specific power: 5–10 kW/kg (10×V-8 engines)
- High energy recovery efficiency: 0.90–0.95 (Lead-acid: 0.6–0.7)
- High specific energy: 100–150 W·h/kg (Lead-acid: 30–35)
- Long service life under deep discharge: more than 10 years
- Long self-discharge time: weeks to months
- No use of hazardous chemicals or high temperatures

**Figure 1.**

**The physics and engineering disciplines involved in the design of an electromechanical battery are in each case well understood.**

---

They include:

- Electromagnetic theory
- Strength of materials (in a non-reactive environment)
- Stress analysis
- Stability of dynamical systems
- Vacuum technology

**Figure 2.**

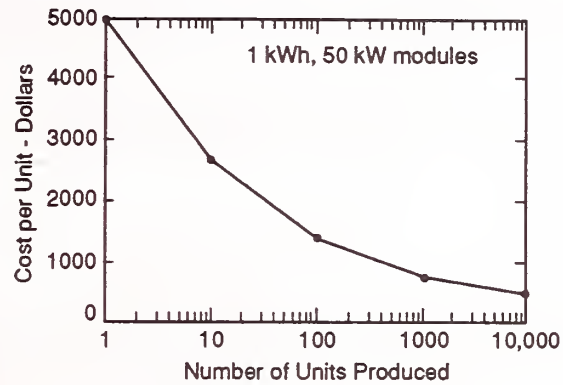

**Figure 3.** Electromechanical battery unit cost projections. The projected cost per kilowatt of high-power electromechanical batteries is comparable to the cost per kilowatt of the power electronics.

**We have made substantial progress toward the goals of our presently funded electromechanical battery prototype development project.**

- Theoretical analysis of the stability of the bearing/suspension system
- Finite-element and theoretical analyses of rotor stress distributions
- Vacuum tests of sealed chamber containing simulated rotor
- Tests of Halbach array generator
- Sub-system tests of mechanical "backup" bearings
- Sub-system testing of support and damping elements of Lawrence Livermore National Laboratory passive magnetic bearing designs
- Design and construction of solid-state drive electronics
- Design, construction, and initial testing of first prototype electromechanical battery

**Figure 4.**

# PROMISING FUTURE ENERGY STORAGE SYSTEMS: NANO-MATERIAL BASED SYSTEMS, ZN-AIR, AND ELECTROMECHANICAL BATTERIES

R. Koopman and J. Richardson  
Lawrence Livermore National Laboratory  
Livermore, CA 94550

## ABSTRACT

Future energy storage systems will require longer shelf life, higher duty cycles, higher efficiency, higher energy and power densities, and will be fabricated in an environmentally conscious process. This paper describes several possible systems that have the potential of providing stored energy for future electric and hybrid vehicles. Three of the systems have their origin in the control of material structure at the molecular level and the subsequent nano-engineering into useful devices and components: aerocapacitors, nano-structure multilayer capacitors, and the lithium ion battery. The zinc-air battery is a high energy density battery that can provide vehicles with long range (400 km in autos) and can be rapidly refueled with a slurry of zinc particles and electrolyte. The electromechanical battery is a battery-sized module containing a high-speed rotor integrated with an iron-less generator, which is mounted on magnetic bearings and housed in an evacuated chamber.

## INTRODUCTION

Future emission regulations are driving the automotive industry towards the consideration of electric and hybrid vehicles. In order to achieve performance comparable with gasoline fueled internal combustion engines, significant improvements in current energy storage technology are required. Specifically, higher energy-densities (energy per unit volume) and specific-energies (energy per unit mass) will be required. Similar improvements in power density and specific power will also be required. Improvements in durability, shelf life, lifetime, and reliability will also be required in order to compete successfully with gasoline as a means of energy storage. Materials and manufacturing processes must be environmentally friendly, with an ability to be recycled high on the list of desired attributes. Most important of all may be the overall economic viability of any proposed new energy storage system.

Advanced materials and manufacturing technology offers several potentially promising new routes to energy storage systems with high energy- and power-densities. Several systems that are being developed and evaluated at Lawrence Livermore National Laboratory are based on understanding

and controlling the nano-structure of materials. These systems are the aerocapacitor, the nano-structure multilayer capacitor, and the lithium ion battery. Another system, the zinc-air battery, takes advantage of past work in metal battery systems using air electrodes and novel self-feeding cell design for the zinc particulate fuel. Finally, the electromechanical battery offers a new look at an old technology taking advantage of new developments in high-strength fiber composites, magnetic bearings, solid-state power electronics, and permanent magnet materials.

## DISCUSSION

### Aerocapacitor.

The storage of electrical energy based on the separation of charged species in an electrolytic double-layer is inherently simpler and more reversible than in secondary batteries. While obviously not batteries, capacitors offer the promise of an efficient, convenient way to store energy for peak demands (e.g., catalyst preheat, acceleration, starting motors, load leveling) and waste heat recovery (e.g., regenerative braking). In most cases the cycle life of electrochemical double-layer capaci-

tors is limited by the device packaging and not by degradation of the device components. Though all electrode-to-electrolyte interfaces exhibit double-layer capacitance, only devices that do not exhibit faradaic reactions over the potential range of operation (i.e., are ideally polarizable) are considered electrochemical double-layer capacitors. The aerocapacitor (Fig. 1) exhibits high double layer capacitance without resorting to faradaic reactions by taking advantage of the unique properties of carbon aerogels [1].

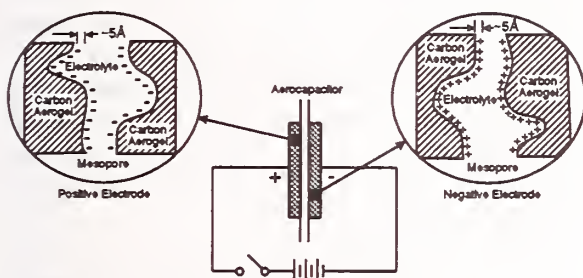
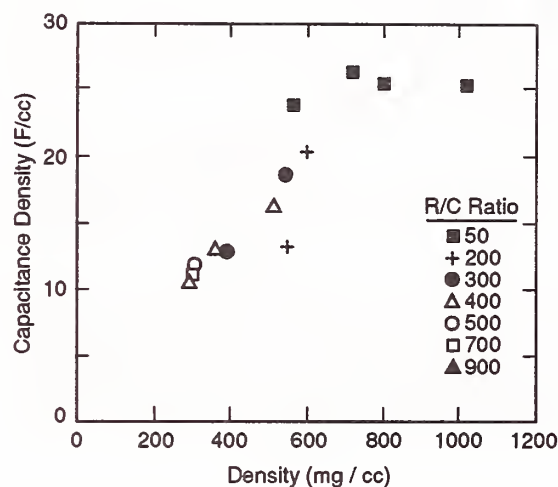

**Figure 1.** Schematic illustration of the enhancement in charge storage capability of an electrochemical double layer capacitor using high-surface-area, open porosity material.

Carbon has the initial advantage of being electrochemically inert. Aerogels are a class of low-density solid foams that are characterized by having open cell structures composed of particles usually less than 50 nm in diameter. Aerogels are usually made from silica precursors, and are noted for their outstanding thermal insulation properties [2]. Aerogels have not been widely used because of the difficulty in producing them (a critical extraction step is required that usually employs high temperature and pressure) as well as the initial high cost of precursor materials.

Recently, organic aerogels have been synthesized by condensing aqueous solutions of resorcinol with formaldehyde in the presence of base catalyst [3, 4]. The microstructure is regulated by the catalyst concentration. These materials routinely have specific surface areas approaching 1000 m<sup>2</sup>/g. For organic aerogels with a high carbon content, such as resorcinol-formaldehyde, pyrolysis in an inert atmosphere results in the formation of essentially pure carbon aerogels. Besides having improved mechanical properties, these materials become conductive and suitable for appli-

cation in energy storage devices. The capacitance density (F/cm<sup>3</sup>) of devices made using these conductive, high-surface-area materials can be as high as 25 F/cm<sup>3</sup> without further surface activation. Figure 2 illustrates the dependence of capacitance on density.

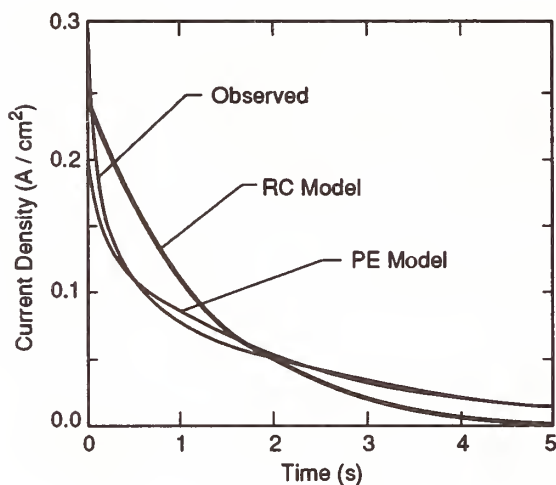

**Figure 2.** Capacitance density (F/cm<sup>3</sup>) for various carbon aerogel catalyst ratios (R/C).

At the higher densities desired to maximize the capacitance, the carbon aerogel material is sufficiently robust to withstand air drying, thus eliminating the critical extraction processing step. Alternate monomer precursors have been demonstrated to also result in suitable carbon aerogel formation; many of these monomers are considerably less expensive than resorcinol, and in some cases the co-monomer, formaldehyde, can be eliminated as well.

The capacitance of the aerogel electrode is complicated by the distributed nature of the porous surface. The equivalent circuit diagram has been analyzed to include the effects of the separator length, the electrolyte conductivity in the separator, the matrix conductivity, and the external resistance. Figure 3 illustrates the observed current discharge compared with the porous electrode distributed model and a simple resistive model.

Energy densities of approximately 25 J/cm<sup>3</sup> have been measured for low-voltage aerocapacitor devices with aqueous electrolyte; the corresponding power-density is about 10 kW/kg carbon. The



**Figure 3.** Observed discharge performance versus porous electrode distributed model (PE) and simple resistive model (RC) for test device illustrated in Fig. 5 and for  $600 \text{ mg/cm}^3$  carbon aerogel,  $R/C = 200$ , from 0.1 to 0.0 V.

use of organic electrolytes, with higher breakdown voltages (i.e., 3–4 V versus about 1 V for water), results in higher energy-densities albeit lower power densities. All of these values exceed Department of Energy projected goals for EDLC in electric vehicles. These devices have been repeatedly charged and discharged, with over 85 percent retention of initial energy storage capability after 100,000 cycles. Current work is directed towards fabricating components and devices of increasing voltage specification; current devices have been limited to approximately 5 V. Reduction in internal resistance and improved manufacturability are being pursued through the incorporation of carbon paper and various methods of incorporating metal fibers into the electrode material.

#### Nano-Structure Multilayer Capacitors.

Multilayer nano-technology [5, 6] offers the possibility of fabricating new material structures with customized properties by controlling the structure [7–9] and hence properties at the near-atomic level. Since nano-engineered multilayers are characterized at the atomic scale they have large interfacial-area-to-volume ratios. Although the most visible of such materials are semiconductor

superlattices synthesized using molecular beam epitaxy techniques, multilayers may be synthesized using elements from all parts of the Periodic Table using molecular beam epitaxy, evaporation, sputtering, and electrochemical atom-by-atom technologies. Multilayer structures have been synthesized by PVD—in elemental form, as alloys, or as compounds—from at least 75 of the 92 naturally occurring elements. The microstructural scale of multilayer materials is typically determined during synthesis by controlling the thickness of the individual layers. These layers are one monolayer (0.2 nm) to hundreds of monolayers (greater than 500 nm) thick and generally define the in-depth grain size. These synthesis processes typically produce highly textured layers with the close-packed lattice plane of the material in the plane of the multilayer, although these grains are randomly oriented in plane.

Until recently, the macroscopic thickness of nano-structure multilayer materials has been generally limited to less than a few microns. Recently, processes for deposition of thick macroscopic nano-structure layers have been developed at Lawrence Livermore National Laboratory [10] and used to fabricate free-standing high-quality structures up to 500 microns thick containing up to 50,000 individual layers. The existing research synthesis system produces material having periods uniform to 2 percent of the individual layer thickness and areas of  $400 \text{ cm}^2$ . These macroscopic nano-structure multilayer materials enable use of standard diagnostic techniques for property characterization and open a path to develop devices with performance that approaches theoretical limits, be it with respect to mechanical properties, magnetic properties, or thermoelectric properties [11]. One application of this technology is the fabrication of capacitors with expected exceptional performance.

A parallel plate capacitor can be fabricated by depositing alternating thin layers of metal and dielectric (Fig. 4). High energy-densities (greater than  $5 \text{ J/cm}^3$ ) should be possible with high operating voltages (in the kV range).

There are several potential advantages to this design. First, a wide range of materials with corresponding different properties can be used. Initial designs are based on a simple dielectric [12], amorphous silica ( $\text{SiO}_2$ ), with a dielectric con-

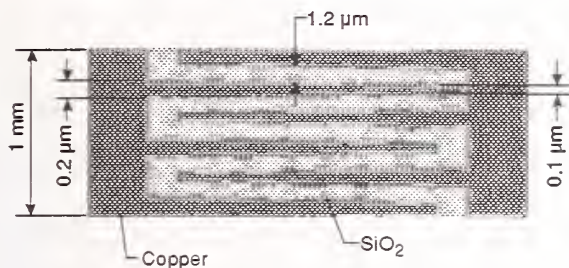

**Figure 4.** Cross section for a typical multilayer capacitor for a 600 V application.

stant of 3 and a maximum standoff field of about  $6 \times 10^6$  V/cm. Standoff fields of these materials in thin film form are not currently well known but are expected to be substantially larger than those observed for commercial bulk materials formed using powder compaction and sintering (less than 105 V/cm). In applications where high capacitance (as opposed to high voltage) is required a high dielectric constant material, BaTiO<sub>3</sub> for instance, would be used. Furthermore, unlike rolled foil with paper or polymer dielectrics, multilayer capacitors are solid-state devices with excellent thermal and mechanical properties due to the low number of defects present. Figure 5 shows the volumetric capacitance and breakdown voltage versus thickness for multilayer capacitors based on amorphous silica (SiO<sub>2</sub>).

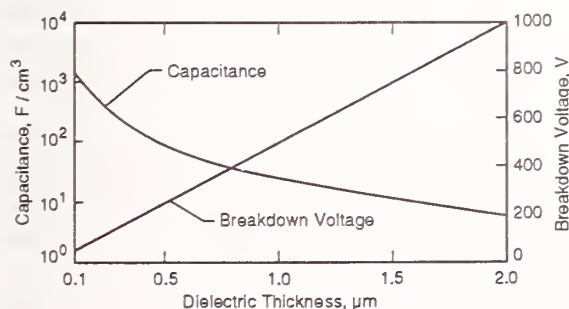

**Figure 5.** Volumetric capacitance and voltage breakdown curves for silica based multilayer capacitors.

A proposed SiO<sub>2</sub> dielectric 100 μF, 600 V device would be  $9.0 \times 5.5 \times 0.13$  cm, and could store 18 J ( $3 \text{ J/cm}^3$ ) if charged to its breakdown voltage. Initial laboratory results using Zr/ZrO<sub>2</sub>/Zr capacitor structures deposited on silicon wafers

have demonstrated the technical feasibility of multilayer capacitors, with measured breakdown voltages of 3 MV/cm for approximately 1.2 microns of dielectric yielding an energy density of  $10 \text{ J/cm}^3$ .

### Lithium ion batteries.

The lithium ion battery is a rocking chair battery, with lithium ions moving from the metal oxide cathode of the battery through the separator and intercalating into the carbon anode [13, 14]. Thus, the intercalating electrodes store the lithium, but are unchanged in so doing. This process is substantially safer than that used in conventional lithium batteries, where lithium metal is electroplated during charging. A substantial fraction of the electroplated lithium metal is typically non-uniform, particulate, or dendritic. With cycling, this leads to a rapidly fading capacity and consequently shorter life. There is also the possibility of dendrites forming, which can puncture the separator and lead to a run-away battery short and explosion.

Lithium-ion-battery specific-energy and energy-density compare very favorably with other batteries, with projected values on the order of 120 W·h/kg in comparison to about 30 W·h/kg for NiCd. Sony, which achieves about 60–70 W·h/kg, claims its batteries can provide 1200 cycles at 100 percent depth-of-discharge or 50 percent more cycles than NiCd (and at 4000 cycles, projections indicate over 40,000 cycles at 30 percent depth-of-discharge). Superior power-density is also available in lithium ion densities, potentially on the order of 250 W/kg at high energy densities, with high voltage (3.0–4.1 V).

Lithium ion batteries hold significant potential for electric vehicle applications; Honda has benchmarked the lithium ion battery for its electric vehicle development. However, to realize this potential additional improvements in performance have to be achieved. For example, Sony's carbon anode achieves approximately 50–60 percent intercalation of lithium. We have developed carbon foams that closely match the ideal spacing in LiC<sub>6</sub> of 3.70 Å coupled with continuous structure and hence lower resistance than carbon particle composites. Up to 95 percent intercalation has been achieved, resulting in higher energy-densities, through doping of the carbon foams. Formatting

reactions are being reduced to lower the amount of lithium lost into the lattice during the initial cycles. Finally, work is progressing on optimizing the lithium metal oxide cathode to improve conductivity and lithium availability in a manufacturable process. Figure 6 illustrates the projected improvement in specific-energy as a function of improved cathode utilization for various levels of carbon utilization.

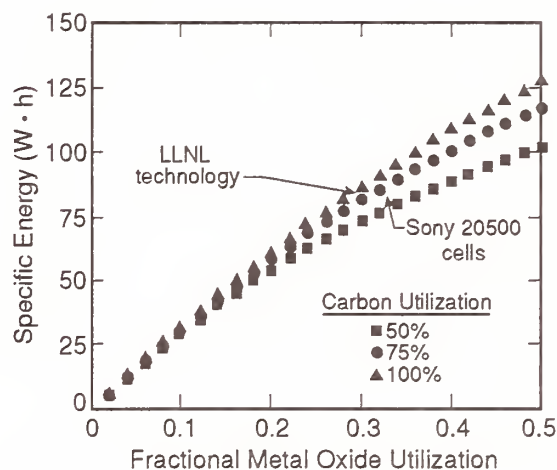

Figure 6. Effects of carbon and lithium cobalt dioxide utilization on energy density.

### Zinc-air batteries

**Background.** We are developing a refuelable battery that provides electric vehicles with the essential functions of automobiles: long range (400 km); safe acceleration; and rapid (10 minute) refueling [15]. The battery consumes one-millimeter-size zinc particles to produce electricity and a liquid reaction product. Refueling consists of a hydraulic transfer of the reaction product and a return flow of zinc slurry to a hopper portion of each cell. The zinc fuel particles are recycled from the product liquid by an external electro-mechanical process. Refueling is particularly attractive for extending the range and mission of fleet vehicles such as transit busses, vans, and taxis or enclosure industrial vehicles such as fork lift trucks, by making use of a fleet's existing home base for both refueling and fuel recycling.

The same fuel recovery process can in principle

be miniaturized and placed on-board an electric car. This would allow overnight electrical recharge while retaining the option for range extension at a service station. This dual mode refueling aids market introduction in advance of an extensive service network. On-board recovery is more difficult and is beyond the scope of our current project.

This fuel battery is limited by power (100 W/kg peak) and not by energy (greater than 150 W·h/kg), but can provide an electric car with performances nearly equivalent to diesel and modest four-cylinder internal combustion engine autos. Attractive acceleration and improved battery life and economy require hybridization with a power device such as a flywheel, high-rate batteries or supercapacitors, which may also be used to recover braking energy.

**Technical Status and Plans.** We have tested a novel battery configuration (600-cm<sup>2</sup> cells) that consumes 100 percent of zinc fuel particles gravity-fed from an overlying hopper. The cell supports an expanded quasi-stationary bed of negligible hydraulic resistance and constant properties. Air and electrolyte pumps consume less than 0.5 percent of the gross output. Peak-power exceeds 5 kW/m<sup>2</sup> at 50 percent discharge; nominal output power is 2 kW/m<sup>2</sup> at 1.25 V. The novel cell configuration has been engineered into 1000-cm<sup>2</sup> cell stacks with internal ("bipolar") series connection for tests in FY1994.

Hydraulic transfer to hoppers using dripless hose connectors eliminates human contact and potential liabilities, and avoids damage to cell membranes by rapidly moving slurry.

The nearest term application of this technology is fleet vehicles. Busses and vans powered by lead-acid batteries have missions of only approximately 4 hours without battery exchange. Zn-air batteries can more than double this at about one-third the weight of lead-acid batteries. The zinc-fuel battery will cost about \$50/kW for large scale vehicles, and allows continuous operation with periodic refueling. Retrofitting the APS/MTD Villager Bus with a fuel battery and flywheel is expected to decrease gross weight by 15 percent (battery weight is reduced nearly threefold), double the range per refueling, and allow 24 hour per day operation where needed. Modeling of a parallel hybrid using zinc-air and advanced high-power secondary bat-



**Table 1.** Estimates of range extension and weight reduction for an urban bus of fixed time-average power of 12 kW (Based on APS Villager Bus, Oxnard, CA)

Battery system	lead-acid	Zn-air, flywheel
Curb weight (tonne)	10.9	9.3
Battery weight (kg)	2500	820 (Zn/air) 100 (flywheel)
Delivered energy (kW·h)	64	125
Peak power (kW)	98	125
Mission duration on charge (h)	5.5	11 (extendible)

teries (for regenerative braking and power peaking) indicates a propulsion cost of approximately 1 kW·h-AC/km and an overall electrical efficiency of 45–50 percent for an 8.2 tonne bus on the SAE-J227a(B) cycle.

Air electrodes using organo-cobalt catalysts and similar to those used in our cells have tested over 12,000 hours in alkaline electrolytes under fixed discharge conditions and temperatures similar to those in a hybrid bus. Still, the electrode cost and life under actual duty cycles are not demonstrated. Other problems include demonstration of closure of the fuel cycle, control of electrode deterioration during cold standby, and optimization of the controller and power device, and the capacity of the electrolyte to hold zinc discharge products as a pumpable fluid.

Zinc may also be used as a vector for hydrogen energy. If the electrowinning of zinc is done with hydrogen reacted at a gas-diffusion anode, the cell voltage drops from 2.2 V to about 0.5 V, giving the vehicle a fossil-fuel-to-wheel energy transfer efficiency of 27–30 percent. This year, we plan to close the fuel cycle by discharging recycled fuel in a bipolar stack of six 1000-cm<sup>2</sup> cells. An engineering design will be completed on a 24-cell stack for on-vehicle testing in an electric bus.

### Electromechanical batteries.

The electromechanical battery (EMB) is a battery-sized module containing a high-speed rotor integrated with an iron-less generator, and

housed in an evacuated chamber [16]. For the electric car, the EMB offers a means for overcoming the limitations of electrochemical batteries in specific power, deep discharge lifetime, and energy recovery efficiency.

In the late 1970s, Lawrence Livermore National Laboratory carried out federally-sponsored studies of flywheel materials and technology. Federal funding for this work was terminated, nationwide, before a practical product emerged. In the intervening years, developments in materials, design concepts, and solid-state power electronics prompted a new look. What has emerged appears far more attractive than the concepts and the designs studied in the earlier work.

**New materials and design concepts.** Besides long service life, two key requirements for vehicular batteries are high specific-energy (W·h/kg) and high specific-power (kW/kg). For an EMB, energy-density is maximized by fabricating the rotor from material with the highest ratio of strength to density. Today, the prime candidate is fiber-composite made from graphite fibers embedded in an epoxy matrix. Commercial graphite fibers now have strengths of 7.0 GPa (1,000,000 psi), heading toward 10 GPa, a factor of five improvement in 20 years. This improvement was achieved mainly through quality control in manufacture. Though costly now, the price for these fibers is heading down as their use increases. Our design studies have centered on the use of graphite fiber-composite for the rotor in an EMB.

High specific-power is essential for snappy acceleration, to absorb high regenerative-braking rates, and to permit fast (5 to 10 minutes) charging times. In an EMB, high specific-power goes hand-in-hand with high rotation-speed. High rotation-speed is achieved by down sizing the EMB module to about the size of a lead-acid car battery. Other advantages of small module size are major reductions in gyroscopic effects, and in containment problems in case of rotor failure. Our design studies have therefore concentrated on small modules, storing about 1 kW·h of energy each. The rotors of these modules are to be of the "multi-rim" type, that is, they consist of a series of nested fiber-composite cylinders, coupled to each other for torque loads by "separators" that insure mechanical integrity and rotational stability.

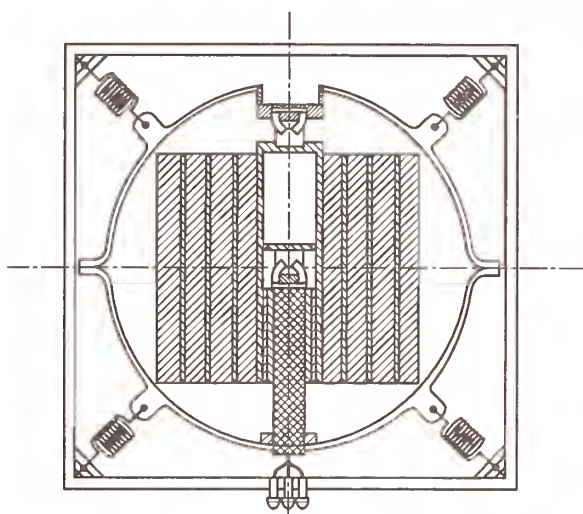

Figure 7. General layout of an EMB module.

**Magnetic bearings—a key technology.** Because the rotor of the EMB rotates in vacuo at speeds as high as 200,000 RPM, the only practical way to support it against the force of gravity, minimize frictional drag, and achieve long service life is to use a magnetic suspension-bearing system. We are now studying new concepts for magnetic bearings that promise to be much simpler and less expensive than the servo-controlled bearings now in use. With these new concepts, it should be possible to design a bearing that will not only accommodate vehicular acceleration loads, but reduce friction under standby conditions to the point that rotor rundown times (self-discharge) of weeks to months should be achievable.

**The generator/motor: the “Halbach Array.”** Another key element in our EMB module is an iron-less generator/motor, the rotating field of which is produced by an array of permanent magnet bars supported against centrifugal forces by the innermost cylinder of the multi-rim rotor. By using the new Nd-Fe-B magnet material, deployed in a special array (the “Halbach Array” [17]), a rotating dipole magnetic field is produced within the assembly. This field then couples, through a re-entrant glass-ceramic sleeve-like vacuum barrier, to three-phase windings lying outside the evacuated region. The absence of hysteresis, windage, and bearing losses leads to high

transfer efficiencies. High rotation frequency results in high specific power—many times that of a V-8 engine.

**The hybrid electric vehicle: a first use for the EMB.** For economic reasons, the first vehicular use of our EMB modules will be in “hybrid” electric vehicles, where one or two EMB provide or accept the peak power required for acceleration and braking, while a conventional electrochemical battery, a fuel cell, or a small heat engine provides average power. If the economics of mass production are favorable, the EMB might, in time, be able to take over the entire job, resulting in an electric car that could compete toe-to-toe with the best internal combustion-driven automobile.

## CONCLUSION

Several promising new technologies have been identified and are being developed for evaluation as potential energy-storage systems suitable for electric and hybrid vehicles. Some of these technologies (i.e., aerocapacitors, nano-structure multilayer capacitors, lithium ion batteries) take advantage of the ability to control materials at the nano-scale, and hence to exert profound control over the resulting macroscopic properties. Other promising technologies (zinc-air and electromechanical batteries) take advantage of new processing and systems design, in addition to modern materials.

## REFERENCES

- [1] S. T. Mayer, R. W. Pekala, and J. L. Kaschmitter, “The Aerocapacitor: An Electrochemical Double-Layer Energy-Storage Device,” *J. Electrochem. Soc.*, Vol. 140, pp. 446–451, February, 1993.
- [2] L. W. Hrubesh and R. W. Pekala, “Thermal Properties of Organic and Inorganic Aerogels,” *J. Mat. Res.*, Vol. 28, in press, October, 1993.
- [3] R. W. Pekala, “Organic Aerogels from the Polycondensation of Resorcinol with Formaldehyde,” *J. Mat. Sci.*, Vol. 24, pp. 3221–3227, 1989.
- [4] R. W. Pekala, C. T. Alviso, and J. D. LeMay, “Organic Aerogels: A New Type of Ultrastucture Polymer,” in *Chemical Processing of Advanced Materials*, L. L. Hench and J. K. West, eds., (New

- York: John Wiley & Sons, Inc., 1992), pp. 19–27. Work performed under the auspices of the U.S. Department of Energy by the Lawrence Livermore National Laboratory under contract No. W-7405-ENG-48.
- [5] T. W. Barbee, Jr., "Multilayer Structures: Atomic Engineering in It's Infancy," in *Physics, Fabrication and Application of Multilayer Structures*, ed. by P. Dhez and C. Weisbach, Plenum Press, New York, NY (1988) p. 17.
- [6] T. W. Barbee, Jr., "Synthesis of Multilayer Structures by Physical Vapor Deposition Techniques," in *Synthetic Modulated Structures*, L. L. Chang and B. C. Giessen, eds., Academic Press, Orlando, Florida, USA (1985).
- [7] R. Frahm, T. W. Barbee, Jr., and W. K. Warburton, "In-Situ Structural Study of Thin Film Growth by QEXAFS," *Phys. Rev. B*, Vol. 44, p. 2822 (1991).
- [8] T. W. Barbee, Jr. and J. Wong, "EXAFS of Near Monolayer Hafnium Film," *Physica B*, Vol. 158, p. 670 (1989).
- [9] T. W. Barbee, Jr., "X-ray Evanescent-Standing Wave Fluorescence Studies Using a Layered Synthetic Microstructure," *Mat. Lett.*, Vol. 3, p. 17, (1984)
- [10] T. W. Barbee, Jr., "Nano-structure Multilayer Materials," in *State of the Laboratory, Lawrence Livermore National Laboratory (1991)*, UCRL 5200-91-718 (1991).
- [11] L. D. Hicks and M. S. Dresselhaus, "Thermoelectric Figure of Merit of a One-dimensional Conductor," *Phys. Rev. B*, Vol. 47, pp. 16631–16633, May, 1993.
- [12] T. W. Barbee, Jr., D. L. Keith, L. Nagel, and W. A. Tiller, "Controlled Reactive Sputter Synthesis of Refractory Oxides," *J. Elect. Soc.*, Vol. 131, pp. 434–439, February, 1984.
- [13] B. Scrosati, "Lithium rocking Chair Batteries: An Old Concept?" *J. Electrochem. Soc.*, Vol. 139, pp. 2776–2781, October, 1992.
- [14] R. Fong, U. von Sacken, and J. R. Dahn, "Studies of Lithium Intercalation into Carbons Using Non-aqueous Electrochemical Cells," *J. Electrochem. Soc.*, Vol. 137, pp. 2009–2013, July, 1990.
- [15] J. Noring, J. F. Cooper, et al., "Mechanically-refuelable Zn/Air Electric Vehicle Cells," Proc. 183rd Meeting of the Electrochemical Society, Honolulu, Hawaii, May 16–21, 1993.
- [16] R. F. Post, T. K. Fowler, and S. F. Post, "A High Efficiency Electromechanical Battery," *The Proceedings of the IEEE*.
- [17] K. Halbach, Lawrence Berkeley Laboratory Report LBL-21945 (July 1986).

## SESSION REPORT: ELECTRIC PROPULSION SYSTEMS

L. E. Lesster  
Westinghouse Electric Corporation  
Baltimore, MD 21203

### INTRODUCTION

The working session focussed on the Electric Power Train as the common component in both electric vehicle (EV) and hybrid electric vehicle (HEV) propulsion systems. It was recognized that the motor drive electronics—the motor controller—were applicable also to the motor-generator interface with flywheels and also the interface with alternators driven by turbines or conventional internal combustion engines (ICEs). Following system issues, component issues were discussed with emphasis on the key power-conversion and motor components.

The objectives of the session included:

- Establish a forum for discussion of key issues common to electric propulsion systems for EVs and HEVs.
- Achieve a basis for developing common standards, specifications, and test procedures.
- Explore potential new directions for electric-propulsion technology and manufacturing development.

The discussions were used to identify:

- Candidate component technologies for future NIST Advanced Technology Program (ATP) focus.
- Candidate areas for manufacturing advances.
- Areas where standards need to be addressed.

### SUMMARY AND OUTLINE OF WORKING SESSION

#### Standard Basis for Performance Specifications and Candidate Solution Technologies for Both Systems and Components

Selected “strawman” view-graphs that were used to guide the discussion are presented in Appendix A of this report.

A brief introduction was presented on typical performance parameters of a state-of-the-art three-phase induction motor based power train. The following paper [1], “An Induction Motor Power Train for EVs—The Right Power at the Right Price,” which was presented at the ISATA Conference in Aachen, Germany, in September, presents this and supplementary information.

While the need for a common basis for specifications was accepted, the choice, for example, of driving cycle for evaluation purposes was felt to be mission dependent and, within the context of the working session, consensus on specifications was not possible. It was noted that in Ron Sims’ presentation [2], “Electric Vehicle Standards—The Current Status,” specification issues as well as standards appeared to be addressed in some depth by ongoing activities within the Society of Automotive Engineers (SAE). Several key parameters however were discussed in this session, in particular *peak* versus *average* power and the length of time for which peak power should be available, likewise torque capability. It was difficult in many instances to focus on Propulsion Systems (Power Trains) as opposed to performance issues that were either vehicle or battery and power source dependent. One point that met with general approval was the proposition that regeneration should be implemented and adjusted primarily as a means of recovering energy efficiently into the energy stor-

age device (battery, flywheel, or, perhaps, ultracapacitor). While regenerative braking would reduce brake wear, full braking capability should reside in the friction brakes and melding of regenerative braking with friction braking should be transparent to the driver. The technical challenge associated with this, in conjunction with ABS, was acknowledged.

Reliability of electric propulsion systems would have to be better than ICE reliability to succeed in the marketplace and concerns were voiced over the reliability of the power electronics particularly in relation to the thermal cycling issue, which is characteristic of automotive use. It was pointed out that with proper cooling-system design a 5000-hour life was attainable with full performance capability over the automotive temperature range of  $-40^{\circ}$  to  $49^{\circ}$  C. Warranty expectations would be different for different platforms, for example, whereas a car might require 10 years or 100,000 miles, a bus warranty could be 7 years or 300,000 miles.

Maintenance and maintainability issues provoked considerable discussion. In reference to the thermal cycling issue it was felt feasible to use built-in microprocessor capability in motor controllers to monitor and record cumulative thermal cycles. The question of replacement of failed components in dealer service facilities versus replacement of the whole unit found proponents on either side. The potential lack of control over "adjustments" being made in the field was a key issue.

The session members raised surprisingly little challenge to the categorization of induction motor based drives as the present leading technology for power trains. Brushless DC drives were thought to be good candidates for flywheels and either brushless DC or inductor alternators likely candidates for serial hybrid drive alternators. The switched reluctance motor was discussed briefly with its chief attributes being its ability to run at high speed and potentially lower cost construction than induction motors. It was a technology to be followed also in the synchronous reluctance drive configuration. One comment on brushless DC machines indicated that the idea of few losses in the rotor of such a machine was not true if high frequency harmonics were present in the driving waveforms. These could produce considerable eddy current losses in the permanent magnet material. It is the high quality sine wave drives at

high frequencies for flywheel and alternator applications that will drive semiconductor switch (e.g., IGBT) technology to higher speed devices.

Component technology centered on the power switching devices and high voltage high ripple current capacitors. While it was accepted that the IGBT is the component of choice in most instances and at higher voltages, the MOSFET still is effective at lower voltages and higher frequencies. The predominance of offshore manufacture of IGBTs was expressed as an issue and indeed represents a potential cost issue in competing in the world automotive market since the "power bridge" of the motor controller represents a significant part of the cost. The IGBT has enabled the progress in motor drives evident in the last two or three years, but it is still a device (or grouping of devices) that can benefit from improvement in switching speed, conduction loss, and, in particular, lower thermal impedance from junction to heat sink.

High-voltage, high-frequency capacitors for application in power bridges were discussed and the merits of both ceramic and film candidates were considered. It was noted that new film capacitors degrade rather than exhibit single point catastrophic failure. Typical goals for capacitors for bridge applications are 45 amp ripple (5–20 kHz range) and 0.005 ohm. Higher voltage electrolytic capacitor developments were mentioned (voltages to 1200 V and energy storage values to 2 kJ/kg). Ultracapacitors with energy storage to 40 kJ/kg were also mentioned. For an electric propulsion application an internal impedance is required that is low enough to permit high current surges without excessive voltage drop.

### Motor Components

In the motor area the component issue focussed on the speed-and-position feedback device. The position and speed sensors discussed included: resolvers, optical encoders, Hall-effect devices, and speed pickups. The probable eventual removal of the feedback device as sensorless control strategies are perfected was also discussed. The application-specific design of motors for wide-speed-range inverter-controlled systems also offers opportunity for induction-motor design techniques no longer based on 60 Hz techniques.

### Technical, Economic, and Commercial Barriers

#### Technical barriers:

- No insurmountable hurdles
- Focused development will improve product

#### Economic and commercial barriers:

- Cost versus quantity and perceived value
- Component manufacturing investment
- Opportunity charging and infrastructure
- How to define "state-of-wear" for lease and resale markets
- Maintenance of electronics in a mechanics world
- Present public perception of EVs and HEVs

### Manufacturing Issues

#### Requirements and developments for improved manufacturing:

- Drive costs to an order of magnitude lower than traditional power electronics industry standards
- New ways to mass produce electric motors using non-traditional motor construction
- New ways to mass produce power electronic components
- Non-traditional materials and components for electronic assembly
- Flexible manufacturing work cells for low quantity at low cost
- Improved application of U.S. R&D funds to manufacturing process versus product development

### Future Technology

The possible long-term transition to reluctance motor drives; the potential in the long-term for silicon carbide semiconductors, provided the market can sustain quantities to establish cost comparable to silicon; and improvements in high-frequency capacitors and other high-power components such as contactors and current sensors all can produce incremental improvements in the cost-to-performance ratio. The power management and power control for hybrid electric hybrid vehicles represents a significant challenge that must be overcome in an extremely cost effective manner if such hybrid propulsion systems are to succeed. As a general parameter, system efficiency, i.e., efficiency of transfer of power in and out of the various motor/generator and/or energy storage devices in the system via the power electronics unit, must be as high as possible. Striving for ever higher efficiency at affordable cost will drive the continuing search for new technology.

### Standards, Requirements, and Test Procedures

#### Requirements for future standards and test procedures:

- Sponsoring Bodies:
  - Industry
  - SAE
  - UL
  - NEC
  - NHTSA
  - NIST
  - EPRI
- Driving Cycles
- Operating Environments, i.e., thermal, EMI, EMF, etc.
- Standards for Maintenance
- Recyclability of Materials

EMI and EMF issues provided the most discussion. The need for defined standards and specifications as opposed to "the radio works" was clear.

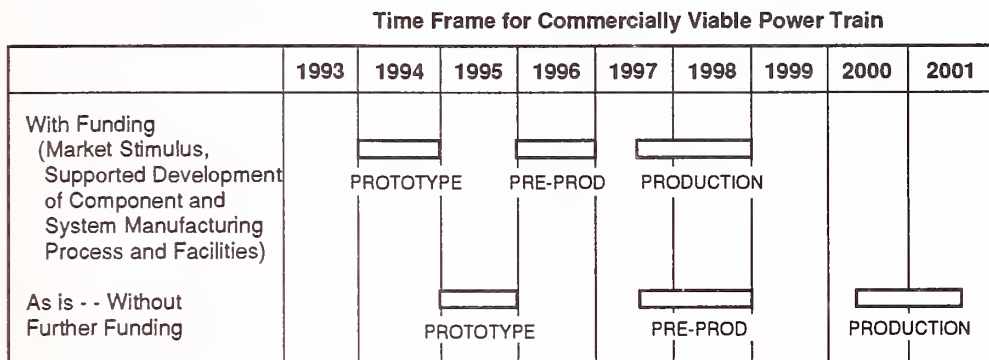

Figure 1. Time frame for development of a commercially viable power train.

Low-frequency fields are an area of growing public concern and need to be addressed in any specification or standard.

**CONCLUSIONS**

Technical recommendations:

- Increase system efficiency above 90 percent
- Develop methods for blending of regenerative braking with ABS and friction brakes and engine drag in hybrids
- Keep the role of regenerative braking for efficient energy storage, not as the primary brake
- Develop load leveling techniques
- Develop higher frequency, higher voltage and smaller power electronics components
- Develop resolverless/sensorless motors
- Improve motor design techniques

Issues for improved manufacturing:

- Component cost drives system cost, not touch labor
- Manufacturing process improvement should focus at the component level

- Power electronics components

IGBTs  
capacitors

contacts  
inductors

- Motor/generator components

rotors  
stators

Two scenarios for the development of a commercial power train are shown in Fig. 1.

**REFERENCES**

[1] L. E. Lesster, F. A. Lindberg, R. M. Young, and W. B. Hall, "An Induction Motor Power Train for EVs—The Right Power at the Right Price" 26th ISATA Conference, Aachen, Germany, September, 1993; reprinted in these proceedings, pp. 170-173.

[2] R. I. Sims, "Electric Vehicle Standards—The Current Status," these proceedings, pp. 53-61.

## APPENDIX A: SELECTED "STRAWMAN" VIEW-GRAPHS

### Performance Specifications

- Establish Common Terminology
- Address Scope/Hardware Content of Electric Propulsion System
- Standardize Definitions for:
  - Power/Peak/Average
  - Motoring Efficiency
  - Speed Range/Torque/Power Envelope
  - Regeneration Efficiency/Energy Recovery
  - Hill Holding/Climbing
  - Reliability
- Role of Power Source Impedance In Specifications
- Systems or Components?

Figure 2.

### Key technologies and their state-of-the-art performance

- Induction motor and vector control
- DC (brushless) permanent magnet motor and field modification control
- Reluctance motor and synchronous or switched control
- DC (brushed) motor and field and armature control
- Synchronous wound rotor motor and stator and rotor control

Figure 3.

### Technology of EV Power Trains—Systems and Components

- Current Technology and Limitations
  - Motors - design, materials and cooling
  - Motor Controllers - design, components, cooling and software
  - Support Components
  - High-power Interconnections/contactors
- Future Developments and Opportunities
  - System Solutions
  - Component Developments

Figure 4.



**Key Components—Motor Controllers**

- Capacitors - high ripple current
- Connectors/relays - High DC voltage and current
- Filter components - EMI and feed-through
- Semiconductors
- Gate drivers - Low voltage/high voltage interface

**Figure 5.****Controller Components**

- Capacitors
  - Ceramic
  - Polypropylene, etc.
  - Electrolytic
- Filter components
  - Feed-through capacitors
  - Inductors/baluns
  - Shielding
- Power semiconductors
  - Thyristors
  - BJTs
  - MOSFETs
  - IGBTs
  - MCTs
- Silicon
- Silicon carbide

**Figure 6.**

## AN INDUCTION MOTOR POWER TRAIN FOR EVs—THE RIGHT POWER AT THE RIGHT PRICE

L. E. Lester, F. A. Lindberg, R. M. Young, and W. B. Hall  
Westinghouse Electric Corporation  
Baltimore, MD 21203

With no rotor saliency, the induction motor inherently offers the potential for smooth propulsion for all-electric and hybrid-electric vehicles (EVs) over the wide speed and torque ranges demanded by applications. Performance must be comparable to that of an Internal Combustion Engine (ICE) in a 2000-kg vehicle. To achieve this, an electric power train must provide peak powers of 75 kW or higher, provide full torque without overheating at very low speeds on hills in traffic, and provide high efficiency at the low cruising powers achieved by modern vehicle design.

The Westinghouse electric and hybrid-electric-vehicle power-train has been designed for just such performance. Prototypes have been built and have been tested in several vehicles for over a year. The transition to a production motor and motor controller has begun. The Chesapeake Consortium, a partnership of Chrysler, The State of Maryland, Baltimore Gas and Electric Company, and Westinghouse has been able to accelerate the development of a production power train by winning a competitive grant from the US Department of Transportation. The premise on which Westinghouse has developed the production power train is that, while legislation and peripheral incentives may be a necessary stimulus to initiate an EV market, more is required. For the EV market to be viable and self sustaining the EV must have the performance the public has come to expect in a personal vehicle and it must be affordable. Thus both the performance and the cost of the power train are market driven.

The performance of the power train is characterized by its torque and power with respect to speed, range, weight, and volume. Its efficiency, smoothness and precision of control, and its ability to operate over the full automotive environment are critical to consumer acceptance. Fig-

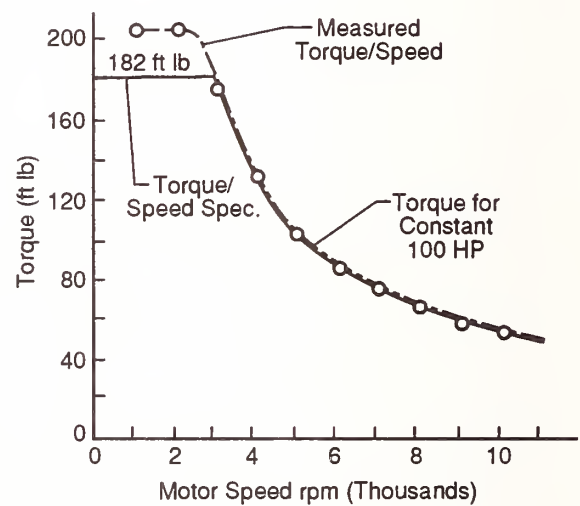

**Figure 1.** Dynamometer test of 100-hp electric power train.

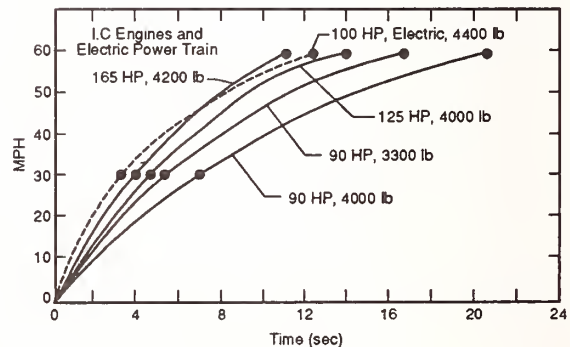

**Figure 2.** Stock pick-up truck performance 100-hp electric drive versus ICE options.

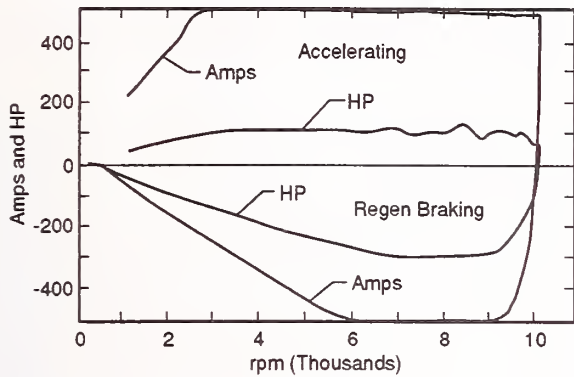

Figure 3. Highway acceleration and regenerative braking of van.

ure 1 shows the design torque/speed curve for the prototype units and also the actual data plotted from dynamometer tests. The degree to which the desired curve has been matched by the test data is an indication of the precision of control over the torque that this vector-control approach possesses. Whether 100 hp (75 kW) is sufficient power for a 2000-kg vehicle can be judged by reference to Fig. 2. This shows the performance curves of a selection of engines in a stock pickup truck. The electric power train with its single speed reducer has much lower engine inertia compared with the internal combustion engine running in its low gears. A 100-hp induction motor drive can give performance similar to a 150-hp ICE as it accelerates. The power capability of the prototype system is demonstrated in Fig. 3 in which the power train accelerates a 5900-lb (2680-kg) vehicle from 0 to 75 mph (120 km/h) in 30 seconds and then uses the induction motor and motor controller to brake the vehicle regeneratively in 10 seconds. It must be recognized that such performance can be achieved in practice only if the vehicle battery or hybrid system can accept energy at the required rate.

The induction motor drive can provide high efficiency over a wide power and speed range. Performance of the prototype system was focused on a 240-V battery with an expected internal impedance of 0.1 ohm. A minimum battery voltage of 180 V or greater could be expected at full load. Figure 4 shows an efficiency plot of the prototype system at these voltages and for compari-

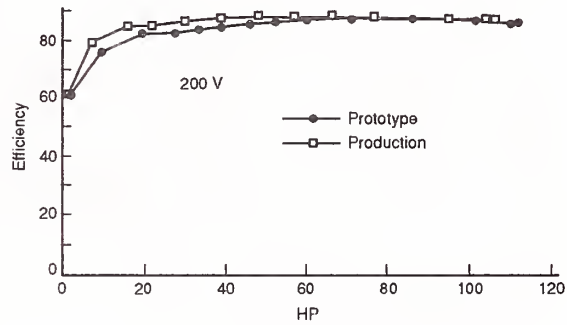

Figure 4. Prototype versus production system efficiency at 3000 RPM.

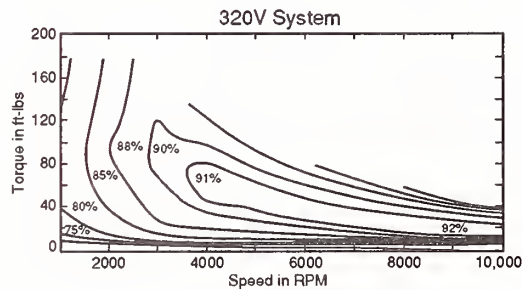

Figure 5. Motor plus controller efficiency.

son the efficiency of the production power train. It is clear that despite the design changes necessary for more cost effective manufacture, performance has been maintained in the production version. Figure 5 by comparison shows the 2 percent to 3 percent efficiency improvement of a comparably powered system at a 300 V nominal battery level. Flux-weakening techniques, which reduce the level of excitation at lower torque levels, in conjunction with a high-efficiency-motor design, lead to this level of performance.

The same motor-controller circuits can be used for the high-voltage system as for the low-voltage system. An extremely wide operating voltage range is imperative for a high-power drive operating from a battery or hybrid power-source. Both will have relatively high internal impedance in relation to the power levels of operation. The effect of this is that in high-power motoring the voltage droops and in high-power regenerative braking the voltage rises sharply. Typically a nominal 300-V DC source could be expected to swing between

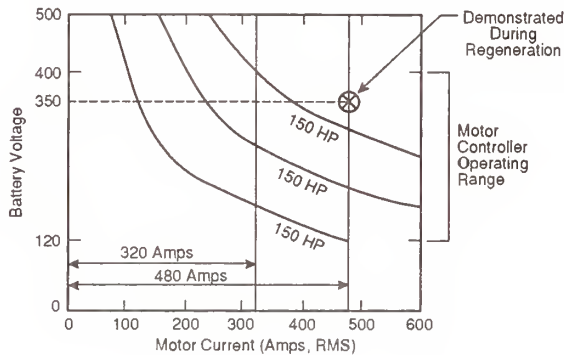

Figure 6. Motor controller operating envelope.

250 V and 350 V as it delivers or absorbs power. The Westinghouse motor-controller is designed to function from 120 to 400 V with adequate stress margins on components. This capability permits greater flexibility for the system designer to adjust power levels by matching battery and motor parameters in relation to motor-controller current options. Figure 6 shows the loci of power train output power as a function of battery voltage and motor-controller maximum current. In this way a family of power trains at power levels of 25 kW, 50 kW, 75 kW, and even 150 kW can be tailored for different vehicle applications. The production motor-controller is based on a modular design of its component assemblies. It is possible to reconfigure its physical layout to meet different vehicle packaging configurations while maintaining the essential design parameters and most importantly an effective EMI (Electromagnetic Interference) barrier.

The transition from prototype to production implies strict adherence to EMI requirements and standards. Meeting these can impose considerable constraints on the mechanical design of the system. This includes the choice of housing materials, numbers of conductors passing through the barrier, and location of modules inside or outside the barrier. Decisions must be made according to function and location. Appropriate filters must be used on all conductors passing through the barrier. Such filters on the high-current cables from the battery, for example, are large. In conjunction with other filter components, choice of shielding material, and RFI (Radio-Frequency Interference)

gaskets for the housing; a weight, size, and cost penalty must be borne if true EMI conformance is required.

In the high-torque operating region of the electric power train high currents circulate through the motor-controller semiconductors. This leads to high heat concentration in relation to the effective cross sectional area for heat transfer from the devices when mounted in the motor controller. Heat flux of 40 W/in<sup>2</sup> (6.2 W/cm<sup>2</sup>) or higher is present. This exceeds the levels normally associated with air cooling if thermal stresses are to be limited and high semiconductor reliability maintained. This is a major issue in connection with operation over the full automotive ambient temperature range of -40° to 49° C, when determining system reliability and operating life, and in setting warranty periods. In transitioning to production it is essential to recognize all the needs for a cooling system. It must protect components from catastrophic failure or degradation over the full temperature range for the vehicle specified operating parameters. It must also keep component temperatures low enough, on the average, in the presence of average ambient air temperatures over the life of the vehicle, that component reliability can support the desired operating life. A 5000-hour operating life is consistent with a warranty of 10 years or 100,000 miles (160,000 km). To achieve this a Mean Time Between Failure (MTBF) of 30,800 hours or greater is required. Parts count, thermal and electrical stresses of components, packaging, and construction techniques must combine in the production unit to achieve these reliability numbers.

Parts count is a major force that drives the system in cost as well as reliability, and weight and volume. Figure 7 shows the progression of parts count and cost multiplier that represents a path to the ultimate cost target, in higher quantities. Such a progression is only possible with the successive infusion of technological advances. The projected production quantities will justify investment in such technology. In the case of the motor-controller power-electronics such investments include the development of ASICs (Application Specific Integrated Circuits) and integrated power-bridge structures. A further profitable area of component count reduction is in the progressive substitution of DSP (Digital Signal Proces-

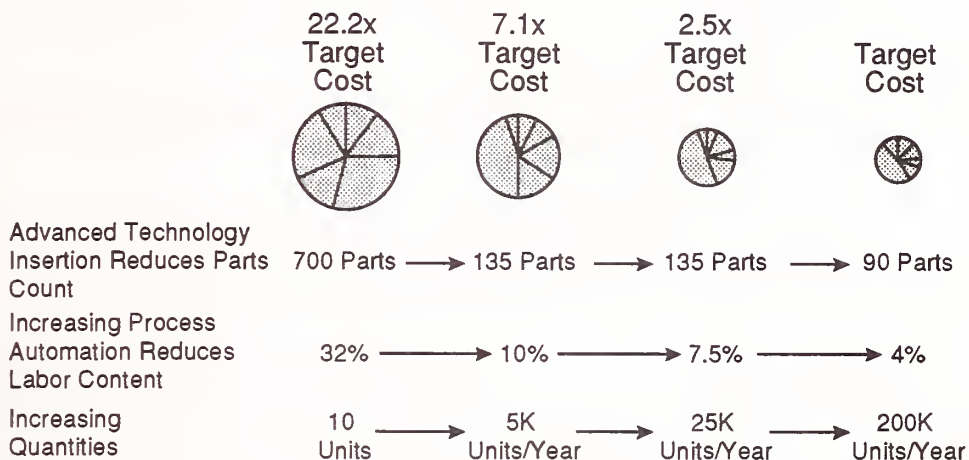

Figure 7. Electric vehicle power train path to target cost.

sor) technology to generate the control functions. The functions can then be accomplished in software rather than in a combination of analog and digital hardware. The effect of this is so dramatic that this has, in fact, been the first technology insertion program to be implemented. It has resulted in a reduction in the vector-control circuit-board area from 1045 cm<sup>2</sup> to 211 cm<sup>2</sup> and future reductions to 150 cm<sup>2</sup> are expected.

A complementary paper [1] describes the design optimization potential of the induction motor. It is transitioned from a traditional design to one focused on the limited-slip variable-frequency performance and design characteristics of a vehicle motor driven via a three-phase solid-state inverter.

REFERENCES

[1] S. Lie and C. DiPietro, "Squirrel Cage Induction Motors for Electric Vehicles," 26th ISATA, Sept. 1993.

## SESSION REPORT: INSTRUMENTATION AND CONTROLS

H. J. King and J. W. Weber  
Delco Electronics/Hughes Automotive Electronics Development  
Los Angeles, CA 90009

### INTRODUCTION

Discussions in this session dealt with the instrumentation, controls, and sensors required to produce and develop salable electric and hybrid electric vehicles. Our objective was to define the current state-of-the-art and future direction of the technology with specific emphasis on the role that government assistance could play in enhancing the technology for commercial use.

Our session was attended by instrument and controls manufacturers and students interested in this aspect of electric vehicle development. Only one member of the automobile manufacturing community attended the session. As a result, the conclusions reflect the component and subsystem suppliers' viewpoint and emphasize a lack of formal specifications and standards, which is an impediment to their work. This is not true within the engineering teams implementing the major car designs. It is a problem that may not be rectified until electric vehicles are sold commercially and the traditional reverse engineering takes place in the retrofit marketplace.

### KEY ISSUES

There were several key issues of generic nature which were common to the subsystems discussed in more detail below.

#### **Instrumentation and controls follow other subsystems development.**

The most desirable situation necessary for an optimum system, is to develop the specification for the controls concurrently with the overall system design. This will permit the proper balance between digital and analog control and between hardware and software implementation. It will also permit the sensors that generate the control signals to

be properly specified and optionally located both electronically and physically in the system.

A separate timetable cannot be given for controls development—it is an integral part of the system design procedure of any vehicle.

#### **Control algorithms are critical components.**

The fundamental algorithms that drive the control process and/or distill and present vital information to the driver or service mechanic give the car its character and "feel." These may be primary factors that will influence a potential customer to buy or reject a car. These algorithms are expensive to develop and their nonrecurring cost are difficult to recover in the production hardware since they take the form of embedded software rather than physical salable hardware.

While the control algorithms must be tailored for each specific vehicle their generic development is an area where government support could materially help speed the process. This could take the form of customizing software tools, system modeling, sensor development, and assistance with collection of human factors data to establish what the vehicle driver really wants. This area is also an excellent area for graduate students to pursue as an introduction to vehicle manufacturing.

#### **There is a need for standard interfaces.**

Mr. Ron Sims' [1] talk earlier in the meeting indicated that much work is underway in several technical societies whose members support electric vehicle development. This is to be commended and supported.

It should be noted that these interfaces take many forms:

- internal to the vehicles (i.e. battery voltage to motor controller)

- vehicle to infrastructure (i.e. battery recharge requirements to power utility)
- vehicle to driver (i.e. energy storage system to display the driving range remaining).

#### **Recurring system costs must be low.**

This can best be achieved by using concurrent design processes to define functions, sensor requirements, and sensor locations while the system is under development and the design is not yet frozen.

#### **Control of a parallel hybrid electric vehicle is significantly more complex than control of a pure electric vehicle.**

The very nature of a parallel hybrid vehicle, the number of operating modes that it can assume and the several paths over which power can flow all increase the complexity of a hybrid electric vehicle. Careful modeling and selection of control techniques and algorithms will be necessary to assure a safe, smoothly operating vehicle that operates continuously in a low emissions mode.

## **DISCUSSIONS**

The very diverse nature of the controls and instrumentation made it convenient to consider the several systems under the headings:

- Energy storage
- Power train performance
- Subsystem controllers (internal interfaces)
- Environmental (external interfaces)

It was also noted that the cost, schedule, reliability, and calibration of instrumentation used to develop hardware differs significantly from the production hardware and software that is part of each vehicle sold.

The charts describing each of these systems and a brief summary of the discussion surrounding each follow.

## **REFERENCES**

- [1] R. I. Sims, "Electric Vehicle Standards—The Current Status," these proceedings, pp. 53-61.

Instrumentation & Controls

## **ENERGY STORAGE**

**NIST**  
Workshop  
October 1993

---

- **MEASURE**
  - Total battery voltage ( $V > 100$  volts)
  - Individual cell voltages
  - Temperature within battery pack
- **OUTPUT**
  - Multiplexed voltages and temperatures
- **USES**
  - Indicate driving range remaining
  - Diagnose battery condition and lifetime
  - Control charging cycle
- **REQUIRED**
  - Voltage sensors and multiplexers that work across high voltage DC
  - Algorithms to interpret cell voltages in terms of charge remaining and battery life.

hjkrist.11/28/93.3

Figure 1.

**Energy storage:**

It is imperative to monitor the power flow and energy storage on the vehicle. This is very difficult to do accurately and cheaply, especially at the high currents and high DC voltages involved.

Some form of information storage will be required to infer the on-board energy remaining from the power flows because the energy can only be measured directly in a few storage systems, such as a flywheel or capacitor. It may be possible to estimate battery degradation over a long period of use by monitoring the maximum energy stored as a function of time or discharge cycles.

There is an opportunity for development of new voltage sensors that can be embedded within the battery cell and can read voltage out to ground potential.



Instrumentation & Controls

**POWERTRAIN PERFORMANCE**

NIST  
Workshop  
October 1993



- **MEASURE**
  - Instantaneous currents, voltages, temperatures in battery pack, power electronics, motor
  - Self-test power electronics
  - Self-test safety system
- **OUTPUT**
  - Dashboard display while driving
  - Self-test data through charger interface or standard test connector
- **USES**
  - Driver assistance
  - Require or preventative maintenance
- **REQUIRED**
  - Various sensors and analytical algorithms
  - Standardized hardware interfaces, data formats, and instrument panel readouts and symbols

hjkrist.11/29/03.5

Figure 2.

**Power train performance:**

Each power train will contain a customized embedded controller that responds to the driver's commands within the limits of the current and voltage available from the battery plus other vehicle related inputs (maximum rpm, wheel slip, etc.).

Some high-level summary of power consumption related to the operator's driving technique may be provided to help the driver extend the operating range attainable with a single battery charge.

Each power train will embody some form of built-in test system to inform the driver of an emergency while the vehicle is in operation and should store failure information to assist a technician when the car undergoes routine or emergency service and repair.

**Instrumentation & Controls**  
**VEHICLE SUBSYSTEM**  
**CONTROLLERS**

**NIST**  
Workshop  
October 1993

---

- **BRAKE BLENDING (REGENERATIVE/CONVENTIONAL)**
  - Give electric vehicle the "feel" of a conventional car
  
- **HYBRID VEHICLE CONTROLLER**
  - Smooth blending of electric and conventional power sources
  
- **ADVANCED MOTOR CONTROLS**
  - Versatility of modern power electronics enables versatile motor controls
  
- **POWER MANAGEMENT**
  - Budget power to accessories and drive train to meet driver needs

hjkrist 11/29/93.7

Figure 3.

**Vehicle subsystem controllers:**

Discussion here centered mostly around the added complexity of parallel hybrid vehicle control systems as compared to pure electric or series hybrid electric drives. Parameter studies and computer modeling are expected to be required to both optimize vehicle design and to optimize the controls.

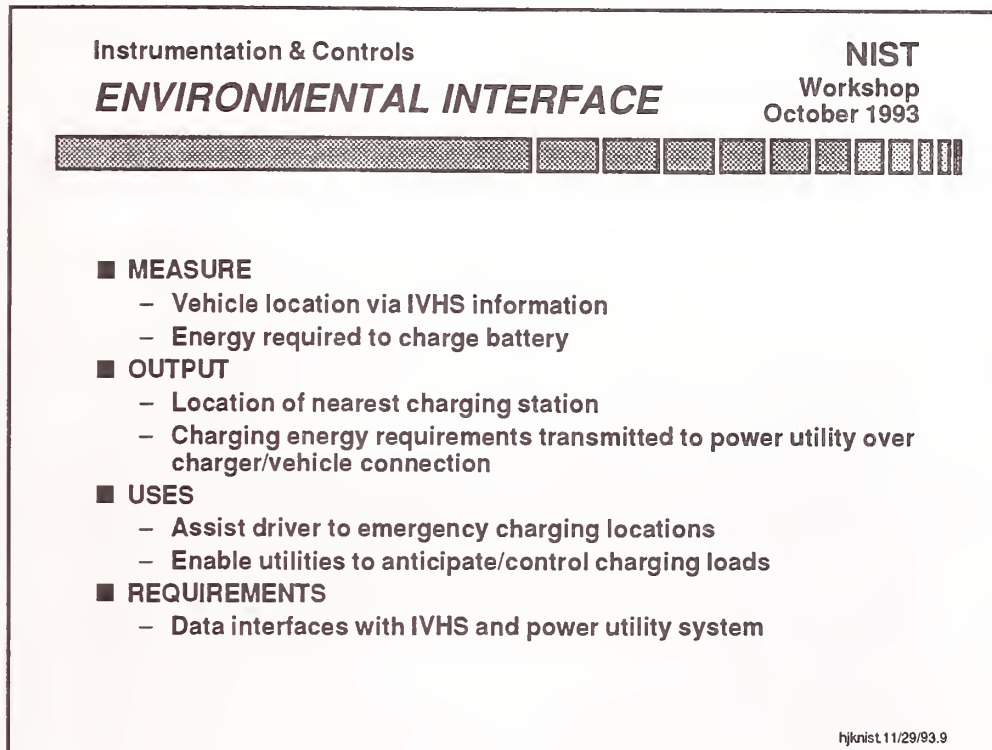

Figure 4.

**Environmental interface:**

This system must be designed to assure that the electric vehicle fleet interfaces smoothly with the electric utility system during the recharging process. With just a few vehicles on the road any impact on the utility will be small. We must anticipate a time when electric vehicles will represent a significant periodic load on the system. At that time the vehicle will be required to automatically announce its anticipated charging requirements to the distribution system so that local distribution systems and transformers are not overloaded.

**Summary:**

The results of the previous discussions are summarized in the two tables that follow. The general conclusion presented earlier and the recommendations were drawn from these data.

Instrumentation & Controls  
**Summary**

**NIST**  
 Workshop  
 October 1993

Topics	Energy Storage	Powertrain
<b>Key Technologies</b>	<ul style="list-style-type: none"> <li>Inexpensive embedded sensors</li> <li>Algorithms</li> <li>Models</li> </ul>	<ul style="list-style-type: none"> <li>Inexpensive embedded sensors</li> <li>Emissions control</li> </ul>
<b>Specifications</b>	<ul style="list-style-type: none"> <li>Safety</li> <li>Fault tolerance</li> <li>Bus interfaces</li> </ul>	<ul style="list-style-type: none"> <li>EMI/EMC</li> <li>Fault tolerance</li> <li>Bus interfaces</li> </ul>
<b>Barriers</b>	<ul style="list-style-type: none"> <li>Inexpensive embedded sensors</li> <li>Technology selection</li> <li>Cost (life cycle?)</li> </ul>	<ul style="list-style-type: none"> <li>EMI/EMC</li> <li>Technology selection</li> </ul>
<b>Opportunities</b>	<ul style="list-style-type: none"> <li>Algorithms</li> <li>Inexpensive embedded sensors</li> </ul>	<ul style="list-style-type: none"> <li>Algorithms</li> <li>Inexpensive embedded sensors</li> </ul>
<b>Manufacturing</b>	<ul style="list-style-type: none"> <li>Cost/packaging (e.g., sensors)</li> <li>Design for service</li> </ul>	<ul style="list-style-type: none"> <li>Design tools (automatic)</li> <li>Design for service</li> </ul>
<b>Timetable</b>	<ul style="list-style-type: none"> <li>Concurrent with system design</li> </ul>	
<b>Standards</b>	<ul style="list-style-type: none"> <li>Bus interfaces</li> <li>Charging interface</li> <li>Sensors for safety monitoring</li> </ul>	<ul style="list-style-type: none"> <li>Bus interfaces</li> <li>Common architectures/interfaces</li> <li>Sensors for safety monitoring</li> </ul>

hjkrist.11/29/93.11

**Instrumentation & Controls**

**Summary (2)**

**NIST**  
Workshop  
October 1993



<b>Topics</b>	<b>Subsystem Controls</b>	<b>Environmental Interface</b>	<b>Development</b>
<b>Key Technologies</b>	<ul style="list-style-type: none"> <li>• Inexp. embed. sensors</li> <li>• Fly/drive-by-wire/light</li> <li>• Control optimization</li> </ul>	<ul style="list-style-type: none"> <li>• Inexp. embed. sensors</li> <li>• Navigation</li> <li>• Emissions monitoring</li> </ul>	• Algorithms
<b>Specifications</b>	<ul style="list-style-type: none"> <li>• Fault tolerance</li> <li>• Bus interfaces</li> </ul>	<ul style="list-style-type: none"> <li>• Fault tolerance</li> <li>• Bus interfaces</li> </ul>	
<b>Barriers</b>	<ul style="list-style-type: none"> <li>• Fly/drive-by-wire/light (perceived liability)</li> <li>• Component cost</li> </ul>	<ul style="list-style-type: none"> <li>• Non-conventional (sales resistance to "new")</li> </ul>	
<b>Opportunities</b>	<ul style="list-style-type: none"> <li>• Algorithms</li> <li>• Inexpensive embedded sensors</li> </ul>	<ul style="list-style-type: none"> <li>• Navigation</li> <li>• Inexpensive embedded sensors</li> </ul>	• Algorithms
<b>Manufacturing</b>	<ul style="list-style-type: none"> <li>• Design tools (automatic)</li> <li>• Design for service</li> </ul>	<ul style="list-style-type: none"> <li>• Design for service</li> </ul>	
<b>Timetable</b>	<ul style="list-style-type: none"> <li>• Concurrent with system design</li> </ul>		
<b>Standards</b>	<ul style="list-style-type: none"> <li>• Bus interfaces</li> <li>• Common architectures/interfaces</li> </ul>	<ul style="list-style-type: none"> <li>• Bus interfaces</li> <li>• Charging interface</li> </ul>	

hjkrist.11/29/93.12

## SESSION REPORT: ANCILLARY SYSTEMS

L. E. Bell  
President, Amerigon Incorporated  
Burbank, CA 91505

### ABSTRACT

Ancillary systems for electric vehicles and hybrid electric vehicles require the development of new technologies to optimize vehicle performance. When each ancillary system is developed individually, the technological improvements often only marginally contribute to improving the overall vehicle's performance. When, however, the available technology for each ancillary system are evaluated, developed, and optimized in tandem with the other systems, the collective technological improvements can significantly increase overall vehicle performance. To maximize the benefit of this strategy, collective component and system technology selection and development must be addressed early in the design phase. Similarly, the infrastructure systems required to support the use of such vehicles by the consumer and community must be evaluated and integrated in a timely fashion to support final vehicle design and introduction. Specific suggestions for future workshop topics have been addressed in the appendix.

### INTRODUCTION

Government officials from around the world are supporting electric vehicles and hybrid electric vehicles as a solution for pollution and petroleum dependence. In the U.S., for example, State air quality officials have mandated that 10 percent of all new cars sold in California by the year 2003 be "zero emission." That could be as many as 150,000 electric vehicles per year. Similar regulations in other states could require that a total of 400,000 electric vehicles be produced per year in the United States.

Amerigon Incorporated and Westinghouse separately estimate that the global electric vehicle industry will total \$8 billion by the turn of the century as a result of the government programs and consumer demand. Anticipated demand for electric vehicles creates a need for many new advanced component technologies. Approximately 70 percent of the components in electric vehicles must or should change from their conventional counter parts to improve vehicle performance and make them acceptable to consumers.

Examples of components that must change or are new to such vehicles include the battery charger, brakes, energy management sys-

tem, power steering assembly, voltage and current sensors, external lighting, DC-to-DC converters, and the heating, ventilation, and air-conditioning (HVAC) system. When these ancillary systems are developed collectively, with consideration given to how each will interact and integrate with the other, the overall resulting vehicle performance can be greatly increased.

### IDENTIFYING ANCILLARY SYSTEMS

In preparation for the workshop, over thirty ancillary systems and their respective components were first identified. The eight specific components that were finally chosen represented those areas in which either the greatest energy improvements could result, or were determined to be the most important to the success of electric and hybrid vehicles. The eight components selected were:

- Battery Chargers
- Brakes
- Energy Management System
- Power Steering Assembly
- Voltage and Current Sensors

- External Lighting
- DC-to-DC Converters
- HVAC

### KEY TECHNOLOGIES AND THEIR STATE-OF-THE-ART PERFORMANCE

Chart 1 in the appendix lists a definition of the components along with the status of the key technologies they employ. It further lists other possible technologies (i.e., other technologies that today have not been utilized or were not viewed as the primary approach by the workshop), today's capabilities for each component, target capabilities for the future, and any special comments concerning the component. The goal was to describe in more detail the capability of each ancillary system's contribution to electric and hybrid vehicles. The information contained on the charts became a road map from the current status of the technology to the direction each technology should take in the future.

The discussion focused in terms of each technology's evolution over the next five to ten years. The ancillary systems and components identified were chosen because (1) they are relevant to today's industrial and business creation endeavors, and (2) they should be investigated from a technology perspective today with the idea in mind that they can make near-term contributions to the emerging hybrid and electric vehicle industry. Through the course of discussion, it was noted that some of the components employ alternative solutions that can be further explored. The following is a summary of the comments made in the session.

#### Battery Charging

There are two types of battery charging systems under evaluation. There is the traditional plug connector type and inductive charging systems. A careful analysis should be made of each so that over time one of the two technologies can be identified as the near-term solution while the other is evaluated for long-term development.

#### Braking Systems

Braking systems have one basic near-term approach—hydraulic with regenerative braking. The second system which holds promise are the systems that incorporate Antilock Braking System (ABS) and traction control. It was the general belief that Anti lock Braking Systems and traction control are likely to be found on more cars in the near future. Consequently, braking systems for hybrid and electric vehicles should have ABS and traction control capabilities.

#### Heating, Ventilation, and Air-Conditioning

With heating, ventilation, and air-conditioning (HVAC), there are several types of systems. The systems receiving greatest attention are very high-efficiency heat pump devices. HVAC systems in very hot or cold conditions become a major consumer of energy and the reduction of energy demand is critical to the range of electric vehicles. The effect can be as much as a 30 percent decrease in the range of an electric vehicle for air-conditioning and heating at extreme conditions. The need is to have available much more efficient HVAC systems with compressors that can provide excellent heat pump performance over a very broad temperature range.

Alternative forms of HVAC such as resistive heating and waste heat capture were considered marginal because of high energy consumption or limited performance. They were viewed as supplementary systems. In the case of waste heat capture, most hybrid vehicles can use waste heat from auxiliary power units. Electric vehicles with high-temperature battery systems can extract heated air from the battery pack.

Another system that is under development is a Peltier-based solid-state heat pump device. The system shows promise at lower heating and cooling capacities with the best application being spot heating and cooling in such places as seats and for defrosting mechanisms. This system does not seem capable of providing air-conditioning that can heat and cool the entire vehicle unless the performance of Peltier junctions improves.

### Power Steering Assembly

The principal approach with the power steering assembly is to develop a hybrid electric system as the boost mechanism which will equal that of today's hydraulic systems. An alternative pure electric system's primary concern is that all of the possible failure modes be fully addressed so that there are no increased liability risks beyond those of current hydraulic systems. Electric systems must be designed to fail in a safe mode to assure that any failure does not cause steering to become erratic or the car to swerve.

### CURRENT TECHNICAL, ECONOMIC, AND COMMERCIAL BARRIERS OF THESE COMPONENTS

Participants next reviewed current technical, economic, and commercial barriers. The major results are summarized in the charts in the appendix. Additional comments from the session follow below.

### Battery Charging Systems

Some components and technologies might have barriers such as non-concurrence among the various resources as to which system to use. Charging systems were of particular interest in this regard as compatibility is particularly critical since this component interfaces with the charging infrastructure. They are not just an internal part of the electric vehicle and, therefore, are not necessarily controllable by the automobile manufacturers. Its will take a coordinated effort with electric utilities and gas stations to provide quick charge systems and opportunity charging systems. Efforts to use opportunity charging systems to entice people to a specific location (e.g., restaurant or theater) require a system that is consistent nationwide.

### Brake Systems

Electric brakes have significant technical barriers directly related to reliability (actually the same failure mode concerns as was noted for the power steering assemblies above). In addition, the regeneration must work effectively and be compatible with conventional friction brakes. When regeneration is in use and the friction braking takes

over (e.g., when the car slows to very low speeds), then smooth transitions must occur. Secondly, the systems must not introduce new product liability issues.

### HVAC

HVAC presents an especially important technical challenge. It is an area that needs to receive a great deal of effort and attention and will add a great deal to the range of electric vehicles if the technology is well designed and developed. Conversely, if such systems are done poorly, they will decrease the range of electric vehicles in extreme temperature conditions. While there are several potential solutions, none has created concurrence that the solution is at hand. This is one area that was recommended for additional technical review and effort.

### POSSIBLE SOLUTIONS TO TECHNICAL BARRIERS

This area was not discussed directly, but was reviewed indirectly as sideline discussions related to the other topic areas. Portions of these discussions focused on the possible solutions to technical barriers. This included determining their technical feasibility and the development time required. Discussion also focused on whether the development costs would be high or low, and whether the solutions are highly important to the success of electric vehicles, or are just marginally important. Determining this information then allows a prioritization of technical approaches. Results are summarized in the appendix charts.

### IMPROVED MANUFACTURABILITY AND MANUFACTURING NEEDS

Although the workshop did not complete a detailed discussion on needs, the objective was to understand if there is some key process, component, or cost item that can enable cost effective manufacture.

### Battery Charging Systems

In the charging system, the production cost of the high-current carrying component is the barrier.



It is imperative that the cost of high-speed high-current switches such as IGBTs be reduced. In the case of inductive systems, the complexity of the systems must be reduced along with the component count. Reducing the complexity and number of components correspondingly reduces the overall electronic control system cost.

### **Brake Systems**

Brake systems must be fail-safe and have very fast actuators that are low cost and highly reliable.

### **Energy Management Systems**

The energy management system requires low cost voltage, current, and temperature sensors. Energy management systems are likely to use large quantities of sensors—as many as one for each battery cell or a minimum of one for each battery.

### **Sensors**

Voltage and temperature sensors must be able to interface with arrays of these devices and the devices themselves must be very low cost as noted directly above.

### **Steering Assemblies**

Steering assemblies have the need for highly reliable parts and fail-safe systems that can be manufactured in high volume at low cost.

### **HVAC**

HVAC requires that the systems have high-efficiency parts that can be manufactured in large quantities. Heat pump systems that operate effectively over a broad temperature range generally are not available in high volumes at low cost. In the case of solid-state devices, the cost of Peltier junctions must be reduced and the system capacity must be increased.

### **DC-to-DC Converters, External Lighting, High-intensity Discharge Systems, Sensors**

For DC-to-DC converters, cost is still an issue and the high cost of power switching devices is the main concern. External lighting has the issue of cost reduction for low energy consumption. High

Intensity Discharge (HID) systems require significant cost reduction while halogen systems require significant power reduction. Voltage and Current Sensors must have the ability to have low cost, simple to use arrays of such devices. One possible solution might be to integrate them directly into the batteries.

### **SCHEDULE/TIMETABLE FOR COMPONENT DEVELOPMENT**

Schedules and timetables were not discussed as an individual topic, although the subject came up throughout the workshop. A summary of related discussions follow.

Each component has several potential timetables. One timetable is for the first generation of components that are needed for the development of hybrid and electric vehicles at this time. Prototypes are generally available at present, however, there needs to be a clear path for the technology to mature to the extent that it can be integrated into a first or second generation of production vehicles.

Vehicles under development today will utilize components that are presently available. The next generation of electric vehicles will use the next generation of components. To have the components qualify for the second generation of electric vehicles, they must have technologies that are accepted and demonstrated, and they must be well along the manufacturability process. This means that the technologies and prototypes must mature and in general be available within the next year for prototyping.

For parts intended for use in vehicles in the near term, there must also be a clear, secure path to mass manufacture components within the next several years. If components do not have that capability, then they will fall into follow-on categories related to improving hybrid and electric vehicle performance in the future.

The products that need to have great emphasis to make them available in the second or third phase are pure electric braking systems and electric power steering assemblies. Both of these are in a state of development that has not demonstrated complete capability. Consequently, there needs to be significant emphasis on readying them for manufacture. Similarly, external lighting needs continued development and DC-to-DC converters

need to be developed further to reduce costs.

HVAC systems are in an early state of development, but their development timetable is critically important to electric vehicle production. The critical issue with HVAC is to have the new systems prepared and tooled for mass production. Greater emphasis must be placed on creating prototypes, early evaluation of prototypes, and quick resolution to manufacturing barriers.

#### **STANDARDS OR TEST PROCEDURES TO BE DEVELOPED**

Information related to this topic was covered in a generic, but comprehensive way in the article entitled, *Electric Vehicle Standards—The Current Status*, by Ron Sims [1]. The viewpoint of the workshop was that the sources referred to should be reviewed and used as the primary resource as the standards become available.

#### **KEY PERFORMANCE SPECIFICATIONS FOR THE NEXT GENERATION COMPONENTS**

A discussion of the Society of Automotive Engineers' (SAE) Electric Vehicle (EV) standards and specifications is contained in the article referenced above.

#### **CONCLUSIONS**

Ancillary Components hold the potential for significantly improved cost-to-benefit ratios for hybrid and electric vehicles. Their continued integrated development will ultimately result in lower-cost components and increased energy savings. Meanwhile, government agencies should look for additional means to support the development of key components and enabling technologies. Proprietary components employing advanced technologies can give U.S. businesses the opportunity to achieve an economic and technology edge in world markets by supplying the ancillary components for these emerging markets.

The workshop provided benefit by focusing attention to the need for advanced ancillary systems. It also helped by identifying key needs to make advanced systems available. Finally, it provided a

road map that can help guide government efforts to facilitate early introduction.

#### **REFERENCES**

- [1] R. I. Sims, "Electric Vehicle Standards—The Current Status," these proceedings, pp. 53-61.

Table 1. Key technologies and their state-of-the-art performance

Component	Primary Technologies	Other Possible Technologies	Capabilities Today	Target Capabilities	Comments
<b>Battery Charger</b>	<ul style="list-style-type: none"> <li>• Plug connector</li> <li>• Inductive</li> </ul>	Battery exchange	Prototypes available	<ul style="list-style-type: none"> <li>• Higher speed</li> <li>• Safe, fool proof</li> <li>• Greater efficiency</li> <li>• Compatibility with all battery types</li> <li>• Cost</li> <li>• User friendly</li> <li>• EMI reduction</li> <li>• Power quality</li> </ul>	New infrastructure required for both systems
<b>Brakes</b>	<ul style="list-style-type: none"> <li>• Hydraulic with regenerative braking</li> <li>• ABS and traction control</li> </ul>	Mechanical or electric	<ul style="list-style-type: none"> <li>• Electric used on trucks, trailers</li> <li>• Hydraulic prototypes available</li> </ul>	Pure electric system with programmable regeneration	<ul style="list-style-type: none"> <li>• Reliability may be difficult to demonstrate</li> <li>• Pure electric reliability may be difficult</li> <li>• Performance differences invisible to user</li> </ul>
<b>Energy Management System</b>	Digital signal processing	<ul style="list-style-type: none"> <li>• Multiplexing</li> <li>• Fuzzy logic</li> <li>• Neural network</li> </ul>	Prototypes in development	10-15 percent efficiency increase for EVs and hybrids	Can be integrated into other on-board systems

Table 1a. Key technologies and their state-of-the-art performance (cont.)

Component	Primary Technologies	Other Possible Technologies	Capabilities Today	Target Capabilities	Comments
Power Steering Assembly	Hydraulic electric (HE)	Full electric (FE)	<ul style="list-style-type: none"> <li>FE in very limited use</li> <li>HE prototypes available</li> </ul>	<ul style="list-style-type: none"> <li>Efficiency TBD in HE</li> <li>Frequency response increase needed in FE</li> </ul>	Compatibility with high-voltage battery systems needed
Voltage and Current Sensors	Analog, low-level signal output devices	<ul style="list-style-type: none"> <li>Digital outputs</li> <li>Optical sensors</li> <li>Fiber optic transmission</li> </ul>	<ul style="list-style-type: none"> <li>Analog available</li> <li>Digital prototypes available</li> <li>Optical early prototypes available</li> </ul>	<ul style="list-style-type: none"> <li>Low sensitivity to electric system noise</li> <li>Very low cost</li> <li>Increase accuracy of optical systems</li> </ul>	<ul style="list-style-type: none"> <li>Optical systems exhibit effective noise rejection</li> <li>Desirable to have built-in intelligence that simplifies system</li> </ul>
External Lighting	Halogen	<ul style="list-style-type: none"> <li>High-intensity discharge (HID)</li> <li>LEDs</li> </ul>	<ul style="list-style-type: none"> <li>Halogen available</li> <li>HID in development</li> <li>LEDs available</li> </ul>	<ul style="list-style-type: none"> <li>Significant power reduction</li> <li>Reduced HID cost</li> </ul>	<ul style="list-style-type: none"> <li>Explore fiber optic central lighting</li> </ul>
DC-to-DC Converters	Switching P.S.		Many systems available	<ul style="list-style-type: none"> <li>Significant cost reduction</li> <li>EMI considerations</li> <li>Increased efficiencies</li> </ul>	Cost strong function of costly power switching devices
HVAC	<ul style="list-style-type: none"> <li>Motor driven A/C</li> <li>Resistive heating (R)</li> <li>Waste heat capture (WH)</li> </ul>	<ul style="list-style-type: none"> <li>Scroll type (SC)</li> <li>Compressors (heat)</li> <li>Solid-state heat pumps (SS)</li> </ul>	<ul style="list-style-type: none"> <li>R, WH, A/C available</li> <li>R available</li> <li>SC, SS, T prototypes available</li> </ul>	<ul style="list-style-type: none"> <li>Environ. friendly</li> <li>Significant energy savings</li> <li>Variable power output</li> </ul>	Major impact on EV range

Table 2. Key performance specifications for the next generation of component

Part	Specifications
<p><b>Battery Charger</b></p>	<ul style="list-style-type: none"> <li>• 120 VAC + 240 VAC + high-voltage charging station acceptable.</li> <li>• Fast charge - 15 min. capability at high voltage.</li> <li>• User and vehicle are safe under all conditions.</li> <li>• Controls or accepts controls for charge rate to extend battery life.</li> <li>• Need for on-board and stationary charging components.</li> </ul>
<p><b>Brakes</b></p>	<ul style="list-style-type: none"> <li>• Adaptable to ABS and traction control.</li> <li>• Energy recovery capability.</li> <li>• Balanced proportioning front-to-rear while recovering energy. (This should be transparent to the driver.)</li> <li>• Redundant, reliable system that meets safety standards.</li> <li>• Drivers should notice no difference from ICE vehicles.</li> <li>• Hill-holder may be necessary.</li> </ul>
<p><b>Energy Management System</b></p>	<ul style="list-style-type: none"> <li>• Significant range increase.</li> <li>• Adaptable to different battery and drive train configurations.</li> <li>• Effective fuel gauge.</li> </ul>
<p><b>Power Steering Assembly</b></p>	<ul style="list-style-type: none"> <li>• Minimum power steering motor power only when power steering function is required.</li> <li>• Speed sensitive system desired.</li> <li>• Current weight reduction required.</li> <li>• Significant reliability required.</li> </ul>
<p><b>Voltage and Current Sensors</b></p>	<ul style="list-style-type: none"> <li>• Automotive sensors for high volume, high current.</li> <li>• Noise, temperature, and vibration "insensitivity" in EMI up to 10,000 gauss.</li> <li>• Need for low-cost, reliable, intelligent systems.</li> </ul>

Table 2a. Key performance specifications for the next generation of component (cont.)

Part	Specifications
<b>External Lighting</b>	<ul style="list-style-type: none"> <li>• Small, light-weight, low-cost system</li> <li>• Energy efficient</li> <li>• Smart control capability</li> </ul>
<b>DC-to-DC Converters</b>	<ul style="list-style-type: none"> <li>• Low EMI emission</li> <li>• Cost reduction (mainly power silicon is high cost)</li> </ul>
<b>HVAC</b>	<ul style="list-style-type: none"> <li>• Significant energy reduction over broad temperature range</li> <li>• Possible need for regional options</li> <li>• Zero emissions/environmentally friendly solutions</li> <li>• Light weight</li> </ul>

Table 3. Current technical, economic, and commercial barriers of these components

Component	Characteristics	Technical	Economic	Commercial
<b>Battery Charger</b>	<ul style="list-style-type: none"> <li>● Quick charge capability, high efficiency, convenient</li> <li>● Minimal impact on utility grid</li> <li>● Safe</li> </ul>	<ul style="list-style-type: none"> <li>● Safety capability not demonstrated</li> <li>● Charging rate depends on battery type</li> <li>● Smart charging dependent on battery type that has good power quality, efficiency, and extends battery life</li> </ul>	<ul style="list-style-type: none"> <li>● Workplace charging occurs during high-cost time for electricity</li> <li>● Low cost, accessible systems needed</li> </ul>	<ul style="list-style-type: none"> <li>● No standards for safety or plug capability</li> <li>● Systems satisfy all stakeholders (e.g., utilities, component mfrs., OEMs, U.L., etc.)</li> </ul>
<b>Brakes</b>	<ul style="list-style-type: none"> <li>● Recover energy, reliable, light weight, safety redundancy</li> <li>● Antilock and traction control capability</li> </ul>	<ul style="list-style-type: none"> <li>● Carbon/carbon units need high temp to operate</li> <li>● Balancing and proportioning of regenerative braking and mechanical brakes requires systems innovation and component design to insure reliability</li> <li>● Should be ABS and traction control adaptable</li> </ul>	<ul style="list-style-type: none"> <li>● Product liability issue on modifying brakes slows innovation</li> </ul>	<ul style="list-style-type: none"> <li>● ABS adds over \$100 to system cost</li> <li>● No major issues known</li> </ul>
<b>Energy Management System</b>	<ul style="list-style-type: none"> <li>● Ability to make function transparent to driver while maximizing efficiency and range</li> </ul>	<ul style="list-style-type: none"> <li>● Accurate means for sensing and data management needs to be developed</li> <li>● Accurate battery modeling and controlling needs to be developed</li> <li>● Effective means to prioritize car function and energy flow</li> </ul>	<ul style="list-style-type: none"> <li>● EMS intervention in operator controls could raise safety and product liability issues</li> </ul>	<ul style="list-style-type: none"> <li>● Cost of multiple sensors</li> </ul>

Table 3a. Current technical, economic, and commercial barriers of these components (cont.)

Component	Characteristics	Technical	Economic	Commercial
<b>Power Steering Assembly</b>	<ul style="list-style-type: none"> <li>High efficiency, reliable, light weight, quiet</li> </ul>	<ul style="list-style-type: none"> <li>Motor controller integration</li> <li>Fail safe, durability (electronic and mechanical)</li> <li>Need for quiet, reliable operation</li> </ul>	<ul style="list-style-type: none"> <li>Electric systems have large product liability risk</li> <li>Cost reduction needed for electric motor and controller</li> </ul>	<ul style="list-style-type: none"> <li>Systems for heavy cars needed</li> </ul>
<b>Voltage and Current Sensors</b>	<ul style="list-style-type: none"> <li>Multiple, smart, small, low cost, robust, accurate systems needed</li> </ul>	<ul style="list-style-type: none"> <li>EMI insensitivity</li> <li>Improved signal conditioning</li> <li>Low-cost sensing strategy</li> </ul>	<ul style="list-style-type: none"> <li>Need to lower cost of sensor arrays</li> <li>No low-cost volume manufacturer in place</li> </ul>	<ul style="list-style-type: none"> <li>Availability not adequate</li> <li>Standardization desired</li> </ul>
<b>External Lighting</b>	<ul style="list-style-type: none"> <li>Small packaging, high efficiency</li> </ul>	<ul style="list-style-type: none"> <li>Current systems have low efficiency</li> <li>Inadequate reliability</li> <li>Noticeable warm-up time of HIDs</li> </ul>	<ul style="list-style-type: none"> <li>High cost of electronic controls</li> <li>Variable piece cost too high</li> </ul>	<ul style="list-style-type: none"> <li>None</li> </ul>
<b>DC-to-DC Converter</b>	<ul style="list-style-type: none"> <li>Small, solid-state switching power supplies</li> </ul>	<ul style="list-style-type: none"> <li>Reduction of EMI</li> </ul>	<ul style="list-style-type: none"> <li>High cost of solid-state power switches</li> </ul>	<ul style="list-style-type: none"> <li>EMI generation</li> </ul>
<b>HVAC</b>	<ul style="list-style-type: none"> <li>Energy efficient systems for heating and cooling</li> </ul>	<ul style="list-style-type: none"> <li>Efficient heat pump systems</li> <li>Quick conversion from heating to cooling modes</li> <li>Increased efficiency of Peltier materials</li> </ul>	<ul style="list-style-type: none"> <li>High cost of motor controllers for heat pumps</li> <li>High cost of Peltier materials</li> </ul>	<ul style="list-style-type: none"> <li>Non-pollution construction materials</li> </ul>



Table 4. Possible solutions to technical barriers

Component	Technical Approaches	Technical Feasibility	Development Time	Development Cost	Importance to EV/HEV Commerce
<b>Battery Charger</b>	<ul style="list-style-type: none"> <li>• Fast charge</li> <li>• Inductive</li> </ul>	High	Moderate	Low	High
			Long	Moderate	Moderate
<b>Brakes</b>	<ul style="list-style-type: none"> <li>• Electric</li> </ul>	High	Long	High	Moderate
<b>Energy Management System</b>	<ul style="list-style-type: none"> <li>• Software/Hardware interface module</li> </ul>	High	Moderate	Moderate	High
<b>Power Steering Assembly</b>	<ul style="list-style-type: none"> <li>• Electric</li> </ul>	High	Long	High	Moderate
<b>Voltage and Current Sensors</b>	<ul style="list-style-type: none"> <li>• Optical systems/sensor arrays</li> </ul>	High	Moderate	Moderate	Moderate
<b>External Lighting</b>	<ul style="list-style-type: none"> <li>• Halogen</li> <li>• High-intensity discharge</li> </ul>	High	Short	Low	Moderate
			Moderate	Moderate	Moderate
<b>DC-to-DC Converters</b>	<ul style="list-style-type: none"> <li>• Switching power supplies</li> </ul>	High	Short	Moderate	Moderate
<b>HVAC</b>	<ul style="list-style-type: none"> <li>• Working fluid heat pumps</li> <li>• Solid-state heat pumps</li> </ul>	High	Moderate	High	High
			Moderate	Moderate	High

Table 5. Improved manufacturability and manufacturing needs

Part	Key Needs to Improve Manufacturing Process	Key Needs to Improve Manufacturing Cost
Battery Charger	<ul style="list-style-type: none"> <li>• High volume manufacturing processes must be developed</li> </ul>	<ul style="list-style-type: none"> <li>• Fast Charger - cost reduction of high current carrying component</li> <li>• Inductive - complexity reduced</li> </ul>
Brakes	<ul style="list-style-type: none"> <li>• No major deficiencies</li> </ul>	<ul style="list-style-type: none"> <li>• Low cost, reliable, durable, fail safe, fast actuator</li> </ul>
Energy Management System	<ul style="list-style-type: none"> <li>• No major deficiencies</li> </ul>	<ul style="list-style-type: none"> <li>• Low cost voltage, current temperature sensors</li> </ul>
Power Steering Assembly	<ul style="list-style-type: none"> <li>• No major deficiencies</li> </ul>	<ul style="list-style-type: none"> <li>• Low cost, reliable, durable, fail safe, fast actuators and power switches</li> </ul>
Voltage and Current Sensors	<ul style="list-style-type: none"> <li>• Reliable assembly of optical elements</li> </ul>	<ul style="list-style-type: none"> <li>• Low cost, durable optical cable and connections suitable for automotive environment</li> </ul>
External Lighting	<ul style="list-style-type: none"> <li>• Halogen - none</li> <li>• High-intensity discharge</li> </ul>	<ul style="list-style-type: none"> <li>• None critical</li> <li>• Low-cost power supply</li> </ul>
DC-to-DC Converters	<ul style="list-style-type: none"> <li>• No major deficiencies</li> </ul>	<ul style="list-style-type: none"> <li>• Low-cost power switches</li> </ul>
HVAC	<ul style="list-style-type: none"> <li>• Working-fluid heat pumps (F) - no major deficiencies</li> <li>• Solid-state (SS) heat pumps - automated process for Peltier junction assembly</li> </ul>	<ul style="list-style-type: none"> <li>• F - lower cost assembly</li> <li>• SS - lower cost and higher performance Peltier junctions</li> </ul>

Table 6. Schedule/timetable for component development

Component	Demo Prototypes	Low-volume Production Assemblies	Mass Production
Battery Charger	Plug connector - now Inductive - now	Plug connector - mid 1994 Inductive - late 1994	Plug connector - late 1995 Inductive - late 1995
Brakes	Hydraulic (H) - 1993 Electric (E) - unknown	H - 1993 E - unknown	H - late 1996 E - unknown
Energy Management System	early 1994	early 1995	early 1996
Power Steering Assembly	1993	1993	mid-1996
Voltage and Current Sensors	Optical - early 1994	Optical - early 1995	Optical - early 1996
External Lighting	Halogen - 1993 High-intensity discharge - 1993	1993 1994	1993 1996
DC-to-DC Converters	1993	mid-1994	late 1995
HVAC	1993	early 1994	late 1995

Table 7. Components not reviewed

Covered by other sessions	Components not covered that are candidates for a future workshop	Components not covered in any session
Battery Assemblies Drive Line Motor Motor Controller Transmission/Gear Reduction	Auxiliary Power Unit Body Structure Exhaust Monitoring System IVHS Power Control Switches Safety Systems Suspension Tires Wire Harnesses	Brake, accelerator, steering assemblies Bumpers Doors Fuses and circuit breakers IP Structure Pressure and fluid sensors Radio, speakers, and CD players Seats Speed, position, and motion sensors Underbody Valves, switches, and actuators Windshield wiper assembly Windows

THE NIST ADVANCED TECHNOLOGY  
PROGRAM



## AN INTRODUCTION TO THE NIST ADVANCED TECHNOLOGY PROGRAM

T. Leedy  
Project Manager, Advanced Technology Program  
National Institute of Standards and Technology  
Gaithersburg, MD 20899

### What is the Advanced Technology Program?

The U.S. Commerce Department's Advanced Technology Program (ATP) promotes economic growth and the competitiveness of U.S. business and industry by accelerating the development and commercialization of promising, but high-risk, technologies that underlie a wide range of potential applications.

The ATP assists businesses in carrying out precompetitive, generic research and development to *enable* commercial technologies that offer significant benefits to the nation's economy. The program is managed by the National Institute of Standards and Technology (NIST).

### What support does the ATP provide?

The ATP provides technology development grants, either to single businesses or to joint ventures. The program also may sponsor cooperative research projects between private industry and federal laboratories.

### What is "precompetitive, generic technology?"

"Precompetitive" here means R&D activities up to the stage where technical problems are sufficiently resolved to permit assessment of commercial potential, and prior to development of application-specific commercial prototypes. The ATP will support development of laboratory prototypes and proof of *technical* feasibility, but not commercial prototypes or proof of *commercial* feasibility. At this stage, results can be shared within a consortium that includes potential competitors

without reducing the incentives for the individual firms to develop and market commercial products or processes.

"Generic" technology means concepts, components, processes, or scientific investigations that potentially could be applied to a broad range of products or processes.

### Which fields of technology does the ATP support?

Any.

### Who may apply for ATP support?

Any business or industry-led joint venture may apply for an ATP grant. There is no restriction on size. The ATP provides no direct funding to universities, government organizations, or non-profit independent research organizations, but they may participate as members of a joint venture. Other questions regarding eligibility should be referred to the ATP office.

Awards to individual firms are limited to \$2 million over three years and can be used only for direct R&D costs. Awards to joint ventures can be for up to 5 years and are limited only by available funds, but the ATP will fund no more than 50 percent of the total R&D cost of a joint venture. Applicants may submit more than one proposal.

### How are projects selected for ATP funding?

Selections are made through a multistage evaluation process. Proposals first are

screened for compliance with the basic program requirements. Technical experts then evaluate each proposal for scientific and technical merit. Those rated highest are then rated for:

- ✓ the potential of the proposal for broad-based benefits to U.S. industry;
- ✓ the technology-transfer benefits of the proposal;
- ✓ the experience and qualifications of the proposing organization; and
- ✓ the proposer's level of commitment and organizational structure.

A small group of "semi-finalists" are asked to make oral presentations at NIST and, in some cases, site visits may be made to assess special facilities. Final decisions will be based upon:

- ✓ assuring an appropriate distribution of funds among technologies and their applications;
- ✓ the rank order of the applications on the basis of all selection criteria; and
- ✓ the availability of funds.

#### **When may applications be submitted for ATP awards?**

Unsolicited proposals will not be accepted. NIST publishes announcements calling for ATP proposals in the *Federal Register* and *Commerce Business Daily* at intervals that depend on available funding — usually at least once per year.

Proposer's kits containing proposal preparation instructions and the forms required for proposal submission are provided upon request. Only proposals meeting the criteria outlined in the proposer's kit will be accepted, and proposals will be accepted only during the solicitation periods noted in the program announcements.

Upon request, NIST will add your name and address to the ATP mailing list so that you automatically will receive new announcements by mail.

#### **Who will own the rights to developments under the ATP?**

Generally, grant recipients retain title to any intellectual property. They may patent inventions and/or copyright software developed under an ATP grant. Their proposals, however, must contain plans for assuring the use of the property to enhance U.S. economic growth. Specific terms are negotiated at the time the grant is made.

The ATP encourages publication of research results in a manner consistent with preserving copyright or patent rights to the developments. "Publication" here does not refer to disclosure of proprietary information, but rather dissemination of information regarding the new development so that other businesses may become aware of opportunities to license technology developed with ATP funding.

*Proprietary information disclosed by applicants to the ATP is exempt from disclosure under the Freedom of Information Act.*

#### **May foreign firms receive funding?**

Any firm that is not a "United-States-owned company" (i.e., that does not have a majority ownership or control by individuals who are citizens of the United States) may receive an ATP grant *if*

- ✓ the Secretary of Commerce finds that the company's participation in the Advanced Technology Program would be in the economic interest of the United States; *and*
- ✓ the Secretary finds that the country in which the company or its parent company is incorporated affords United-States-owned companies similar opportunities and adequate and effective protection for intellectual property rights.

Further details on these eligibility requirements for foreign-owned corporations are available from the ATP.



**Where do I get additional information?**

Additional material on the program, including a copy of the most recent program announcement (request for proposals) and detailed application information can be obtained by writing to or calling:

*Advanced Technology Program  
A430 Administration Bldg.  
National Institute of Standards and  
Technology  
Gaithersburg, MD 20899-0001  
(301) 975-2636*

NIST has established an "ATP Hotline" with a periodically updated recorded status report on the program. The number is 1-800-ATP-FUND or 1-800-287-3863.

The ATP was established by the Technology Competitiveness Act of 1988 (Subpart C, Section 5131).

January 1993



## INDEX OF AUTHORS

- Barber, K. F. 19-24  
Barsony, S. 26-32  
Bartholomew, R. W. 65-70, 71-75  
Bell, L. E. 182-196  
Bogdanoff, M. A. 102-105  
Bromberg, L. 83-88  
Cackette, T. 3-19  
Christianson, C. 116-130  
Cohn, D. R. 83-88  
Dowgiallo, E. 131-143  
Hall, W. B. 170-173  
Henrikson, G. L. 116-130  
Hsiung, S. 26-32  
Kevala, R. J. 97-101  
King, H. J. 174-182  
Koopman, R. 156-163  
Leedy, T. 199-201  
Leonard, J. H. 102-105  
Lesster, L. E. 164-170, 170-173  
Lindberg, F. A. 170-173  
Lushetsky, J. 146  
Marks, C. 33-39  
Nilsson, A. 147-153  
Paul, M. A. 89-97  
Post, R. 154-155  
Rabinovich, A. 83-88  
Richardson, J. 156-163  
Saunders, H. E. 144-145  
Sims, R. I. 53-61  
Smith, J. R. 76-82  
Sobey, A. J. 65-70, 106-115  
Spiewak, D. R. 26-32  
Weber, J. W. 174-182  
Williams, J. 40-53  
Young, R. M. 170-173







# NIST *Technical Publications*

## *Periodical*

---

**Journal of Research of the National Institute of Standards and Technology**—Reports NIST research and development in those disciplines of the physical and engineering sciences in which the Institute is active. These include physics, chemistry, engineering, mathematics, and computer sciences. Papers cover a broad range of subjects, with major emphasis on measurement methodology and the basic technology underlying standardization. Also included from time to time are survey articles on topics closely related to the Institute's technical and scientific programs. Issued six times a year.

## *Nonperiodicals*

---

**Monographs**—Major contributions to the technical literature on various subjects related to the Institute's scientific and technical activities.

**Handbooks**—Recommended codes of engineering and industrial practice (including safety codes) developed in cooperation with interested industries, professional organizations, and regulatory bodies.

**Special Publications**—Include proceedings of conferences sponsored by NIST, NIST annual reports, and other special publications appropriate to this grouping such as wall charts, pocket cards, and bibliographies.

**Applied Mathematics Series**—Mathematical tables, manuals, and studies of special interest to physicists, engineers, chemists, biologists, mathematicians, computer programmers, and others engaged in scientific and technical work.

**National Standard Reference Data Series**—Provides quantitative data on the physical and chemical properties of materials, compiled from the world's literature and critically evaluated. Developed under a worldwide program coordinated by NIST under the authority of the National Standard Data Act (Public Law 90-396). NOTE: The Journal of Physical and Chemical Reference Data (JPCRD) is published bimonthly for NIST by the American Chemical Society (ACS) and the American Institute of Physics (AIP). Subscriptions, reprints, and supplements are available from ACS, 1155 Sixteenth St., NW, Washington, DC 20056.

**Building Science Series**—Disseminates technical information developed at the Institute on building materials, components, systems, and whole structures. The series presents research results, test methods, and performance criteria related to the structural and environmental functions and the durability and safety characteristics of building elements and systems.

**Technical Notes**—Studies or reports which are complete in themselves but restrictive in their treatment of a subject. Analogous to monographs but not so comprehensive in scope or definitive in treatment of the subject area. Often serve as a vehicle for final reports of work performed at NIST under the sponsorship of other government agencies.

**Voluntary Product Standards**—Developed under procedures published by the Department of Commerce in Part 10, Title 15, of the Code of Federal Regulations. The standards establish nationally recognized requirements for products, and provide all concerned interests with a basis for common understanding of the characteristics of the products. NIST administers this program in support of the efforts of private-sector standardizing organizations.

**Consumer Information Series**—Practical information, based on NIST research and experience, covering areas of interest to the consumer. Easily understandable language and illustrations provide useful background knowledge for shopping in today's technological marketplace.

*Order the above NIST publications from: Superintendent of Documents, Government Printing Office, Washington, DC 20402.*

*Order the following NIST publications—FIPS and NISTIRs—from the National Technical Information Service, Springfield, VA 22161.*

**Federal Information Processing Standards Publications (FIPS PUB)**—Publications in this series collectively constitute the Federal Information Processing Standards Register. The Register serves as the official source of information in the Federal Government regarding standards issued by NIST pursuant to the Federal Property and Administrative Services Act of 1949 as amended, Public Law 89-306 (79 Stat. 1127), and as implemented by Executive Order 11717 (38 FR 12315, dated May 11, 1973) and Part 6 of Title 15 CFR (Code of Federal Regulations).

**NIST Interagency Reports (NISTIR)**—A special series of interim or final reports on work performed by NIST for outside sponsors (both government and non-government). In general, initial distribution is handled by the sponsor; public distribution is by the National Technical Information Service, Springfield, VA 22161, in paper copy or microfiche form.

**U.S. Department of Commerce**  
National Institute of Standards and Technology  
Gaithersburg, MD 20899

Official Business  
Penalty for Private Use \$300