



A11103 391086



# NBS BUILDING SCIENCE SERIES 69

U.S. DEPARTMENT OF COMMERCE / National Bureau of Standards



## NBSLD, the Computer Program for Heating and Cooling Loads in Buildings

~~TA-~~

435

258

no. 69

C. 3

1976



2222

# **NBSLD, the Computer Program for Heating and Cooling Loads in Buildings**

NBS Building Science Series

Tamami Kusuda

Building Environment Division  
Center for Building Technology  
Institute for Applied Technology  
National Bureau of Standards  
Washington, D.C. 20234

Sponsored by

Housing and Urban Development  
451 7th Street, S.W.  
Washington, D.C. 20410

and

The National Bureau of Standards



---

U.S. DEPARTMENT OF COMMERCE, Elliot L. Richardson, *Secretary*

Dr. Betsy Ancker-Johnson, *Assistant Secretary for Science and Technology*  
NATIONAL BUREAU OF STANDARDS, Ernest Ambler, *Acting Director*

Issued July 1976

Library of Congress Catalog Card Number: 76-600028

**National Bureau of Standards Building Science Series 69**

Nat. Bur. Stand. (U.S.), Bldg. Sci. Ser. 69, 398 pages (July 1975)

CODEN: BSSNBV

U.S. GOVERNMENT PRINTING OFFICE  
WASHINGTON: 1976

---

For sale by the Superintendent of Documents, U.S. Government Printing Office, Washington, D.C. 20402  
(Order by SD Catalog No. C13.29/2:69). Price \$4.60 (Add 25 percent additional for other than U.S. mailing).



## Preface

This document comprises the engineering manual for the computer program called the National Bureau of Standards Load Determination Program hereafter referred to as NBSLD. Presented herein are the algorithms for the exact calculation methodology that was developed in the Thermal Engineering Section of the National Bureau of Standards to determine accurate heating and cooling loads for the thermal design of buildings. NBSLD, which is based upon the methodologies presented in this publication, has been available for some time for the purpose of evaluating various building constructions and systems. The program was originally developed as a research tool because none of the commercially available programs had features or the sophistication to enable the evaluation of unconventional designs. NBSLD has been an indispensable tool for studies of numerous HUD housing systems, constructions of the Defense Department and the General Services Administration where non-conventional design conditions had to be evaluated.

As the existence and the capability of NBSLD became known, numerous requests were made to NBS to release the program for public use. This publication is in response to that request. Hopefully, engineers will be able to adopt some of the computational schemes described in this publication to their own programs. A complete Fortran program is attached, although NBS does not claim that the program is optimum from the standpoint of the computer memory allocation or computational economy. It will take additional improvements before the program becomes optimum from those viewpoints. The program documentation is being made available at

this time so engineers can use it for accurate load determination as they seek to conserve energy through improved thermal design of buildings. The author would appreciate receiving reader's comments with respect to the accuracy of this text.

It should be mentioned that some of the subroutine algorithms listed in this publication have already been published in the well known ASHRAE booklet entitled "Procedure for Determining Heating and Cooling Loads for Computerized Energy Calculations". These subroutines were compiled by the author who served as the chairman of the Subcommittee on Heating and Cooling Load Calculations of the ASHRAE Task Group on Energy Requirements for Heating and Cooling of Buildings. The ASHRAE publication, however, contains several critical errors, which have been corrected for use in this volume.

The author is greatly indebted to Dr. J. E. Hill and Mr. J. P. Barnett for their thorough editing of the text, to Mrs. Sharon D. Crampton for her skill and patience in typing the manuscript and to Mr. F. J. Powell for his encouragement to produce the document.

# Table of Contents

	Page
1. Introduction . . . . .	1
2. Fundamentals of Heating and Cooling Load Calculation . . . . .	3
2.1 A Rigorous Method of Calculating Heating and Cooling Loads . . . . .	5
2.2 Approximate Methods of Calculating Heating and Cooling Loads . . . . .	9
3. Unique Features of NBS Load Calculation Computer Program . . . . .	15
4. General Description of NBSLD Subroutines . . . . .	22
5. NBSLD Logic Diagram . . . . .	31
6. References . . . . .	33
7. Appendix A - ASHRAE Task Group Subroutine Algorithms	
CLIMAT - Weather data processing . . . . .	1a
SUN - Basic solar position data . . . . .	6a
CCF - Cloud cover factor . . . . .	15a
SOLAD - Solar radiation intensity . . . . .	18a
TAR - Glass transmission and absorption . . . . .	22a
SHG - Solar heat gain through a window . . . . .	29a
SHADOW - Sunlit area calculations . . . . .	31a
FLJ - Radiation heat transfer exchange factors . . . . .	48a
FI - Interior surface heat transfer coefficients . . . . .	64a
FO - Outside surface heat transfer coefficients . . . . .	65a
ACR - Air cavity heat transfer coefficients . . . . .	68a
XYZ - Conduction transfer functions . . . . .	71a
HEATW - Heat conduction through exposed surfaces . . . . .	79a
SCHEDULE - Internal heat generation . . . . .	86a
Fundamentals of Room Temperature and Cooling (Heating)	
Load Calculations . . . . .	89a
RMTMP - Exact room load calculation . . . . .	94a
ATTIC - Exact attic temperature calculation . . . . .	108a
IHG - Instantaneous heat gain concept . . . . .	109a
HLC - Heating/cooling load calculation by the transfer function method . . . . .	115a
RMRT - Transfer functions for the room temperature calculations . . . . .	122a
HEXT - Heat extraction rate calculation . . . . .	128a
INFIL - Building air exchange calculation . . . . .	129a

Miscellaneous routines

DST - Daylight saving time indicator . . . . .	144a
WKDAY - Day of week identifier . . . . .	145a
HOLIDAY - U. S. holiday identifier . . . . .	149a
PSY - Psychrometric calculations . . . . .	150a

8. Appendix B - Weighting Factor Method of Calculating Heating and Cooling Loads and Space Temperature
9. Appendix C - NBSLD Data Forms
10. Appendix D - Fortran Listing of NBSLD
11. ASHRAE Psychrometric Chart

NBSLD

National Bureau of Standards Heating and Cooling  
Load Determination Program

T. Kusuda  
Thermal Engineering Section  
Building Environment Division  
Center for Building Technology  
Institute for Applied Technology

A comprehensive computer program called NBSLD, the National Bureau of Standards Load Determination program, has been developed at NBS to reflect the time change of the many building parameters which are pertinent to accurate estimation of energy usage for heating and cooling. Current status of heating and cooling load techniques is reviewed. Of general interest are unique features of NBSLD which are not available in existing computer programs. A summary of various subroutines of NBSLD is given along with the detailed procedures for them. These subroutines constitute the recommended subroutine algorithms of the ASHRAE Task Group on Energy Requirements. Complete Fortran listing of NBSLD and data preparation forms are given for those who wish to use the program. The NBSLD computation is on the basis of the detailed solution of simultaneous heat balance equations at all the interior surfaces of a room or space. Transient heat conduction through exterior walls and the interior structures is handled by using conduction transfer functions. The use of heat balance equations, although time consuming in calculation, can avoid the vagueness and uncertainties inherent in the more popularly used weighting



factor approach. In addition, it is more accurate for a specific build-  
design.

Key words: ASHRAE Task Group on Energy Requirements; conduc-  
tion transfer functions; heating and cooling load; National Bureau of  
Standards Heating and Cooling Load Computer Program.



## 1. Introduction

Numerous studies in recent years on the matter of energy shortage lead one to believe that the U. S. demand for energy will very shortly outstrip her power generating capacity and fossil fuel supply. According to a recent report of the Stanford Research Institute<sup>1/</sup>, space heating and cooling for residential and commercial buildings amounts to approximately 20% of the total energy consumed in the United States, which was 60 trillion Btu per year in 1968. Moreover, recent and frequent blackouts and brownouts in the east coast region of the United States are good indications that the electric power demand for summer air conditioning exceeds for certain times, the capability of supply and distribution by the power companies.

It is in this context that new and accurate methodology for energy calculations is most crucial for the design and analysis of the performance of space heating and cooling systems. This is especially true in view of the fact that the current load calculation procedures could lead to the over-design of heating and cooling equipment and imprudent use of energy.

It is generally accepted that buildings can be designed to be energy effective if their thermal insulation is increased; window size, air leakage, and lighting levels decreased; shading devices properly installed; heating and cooling systems adequately designed, installed, and maintained; and their heat storage capability most fully utilized. These energy saving features, however, must be considered with reference to numerous constraints, such as added costs for material, construction and maintenance,

conformance to local building codes, occupancy life styles, aesthetics, construction practices, and availability of equipment.

In spite of these constraints, there is sufficient engineering information and technical basis that exist today to warrant extensive studies on various design alternatives for heating and cooling the building to minimize the wasteful use of energy. Design and operation of heating and cooling systems based upon conventional steady-state calculations, for example, usually result in oversizing of equipment and overheating or cooling of the space to be controlled. An over-design system usually operates at lower efficiency and needs more material (consequently more energy) to produce it, thus creating a vicious cycle.

One effective way to design the heating and cooling systems which is optimum from the standpoint of energy consumption, peak power demand and many practical constraints mentioned above, is to study the building thermal performance by using accurate simulations. Because of the use of computer simulations make it possible to evaluate the sensitivity of various design alternatives on the net energy usage, they can be a very effective tool in the design process. In order for such design studies to be conducted on the computer however, the computer program to be used should be very comprehensive and should indicate the proper response to the change of the many parameters which are pertinent to energy usage. The intent of this document is to present a more detailed calculation methodology than is generally used to make it possible for engineers to reduce the area of approximation, where this is considered desirable, by a rigorous computer simulation of building systems, which consider and take into account most of the variables that affect the building and

system operation.

Refined and sophisticated calculation procedures unfortunately are both time consuming and expensive. Without the use of advanced computer methods, they are literally impossible. The development of such calculation procedures can only be justified on the basis that the more accurate calculation will result in overall savings in energy usage and owning and operating costs and consequently in total life cycle cost due to better design of the building systems, more precise sizing of the equipment, and more carefully controlled operation of the heating and cooling system. There are many indications that such a justification is well warranted.

## 2. Fundamentals of Heating and Cooling Load Calculation

Calculation of the energy requirements of the heating and cooling system of a building involves three major steps which may be carried out simply to achieve approximate results, or with increasing degrees of complexity and sophistication as more accurate and more refined determination of system performance is required. First, is the calculation of heat loss or heat gain to the space which is heated or cooled. Second, is the determination of the heating and cooling load imposed on the system. Third, is the calculation of the energy input to all of the system components to satisfy that load.

The ASHRAE Handbook of Fundamentals<sup>2/</sup> contains the basic information whereby the heating and cooling load of a building may be calculated. Customarily such load calculations are made for the so-called "design conditions" for sizing the equipment and developing the design of the heating and cooling system. However, the "design conditions" normally exist only

for a very few hours, if at all, during a heating or cooling season, Consequently, the actual day-by-day and hour-by-hour heating and cooling load for energy consumption is quite different from that for the design condition. Thus the heating and cooling load calculation for the purpose of estimating "energy requirements" must reflect the actual weather conditions rather than a design condition.

Various methods have been developed in the past such as the "degree day" method or "bin" method for proportioning the design load, to obtain approximate monthly, daily, or hourly loads and consequently provide a basis for determining energy requirements. Insofar as such methods are based on valid approximation procedures and checked against actual operating experience, they provide the base for simplified determination of energy requirements acceptable for the needs of most engineers.

In this section a review of the rigorous methods of calculating heating and cooling loads by means of solving heat balance equations at all the interior surfaces of a room or space is given. Also described are approximate methods in which weighting factors are developed after the heat balance equations have been solved for one set of conditions. The NBSLD calculations follow the rigorous method while the ASHRAE Task Group procedures use the weighting factor method.

In NBSLD the transient heat conduction through exterior walls of the room or space is handled by using conduction transfer functions. The use of heat balance equations at the interior surfaces, although more time consuming, can avoid the vagueness and uncertainties inherent in the weighting factor approach. In addition, it is more accurate for a specific building design.



## 2.1 A Rigorous Method of Calculating Heating and Cooling Loads

A cooling (heating) load is of course the amount of energy that is transferred to (from) the room and simultaneously removed (added) by the conditioning equipment at any given time of interest. To calculate this quantity directly requires a rather laborious solution of energy balance equations involving the room air, surrounding walls, infiltrating and ventilation air, and internal energy sources. The principle of calculation can be demonstrated by considering a fictitious space that is enclosed by 4 walls, a ceiling and floor, and having infiltration air as well as normal internal energy sources. The six equations that govern energy exchange at each inside surface at a given time  $t$  are:

$$q_{i,t} = h_{ci} (t_{a,t} - t_{i,t}) + \sum_{\substack{j=1 \\ j \neq i}}^m g_{ij} (t_{j,t} - t_{i,t}) + RS_{i,t} + RL_{i,t} + RE_{i,t}$$

for  $i = 1, 2, 3, 4, 5, 6$

where

$m$  = number of surfaces in the space

$q_{i,t}$  = rate of heat conducted into surface  $i$  at the inside surface at time  $t$

$h_{ci}$  = convective heat transfer coefficient at interior surface  $i$

$g_{ij}$  = radiation heat transfer factor between interior surface  $i$  and interior surface  $j$

$t_{a,t}$  = inside air temperature at time  $t$

- $t_{i,t}$  = average temperature of interior surface i at time t  
 $t_{j,t}$  = average temperature of interior surface j at time t  
 $RS_{i,t}$  = rate of solar energy coming through the windows and absorbed by surface i at time t  
 $RL_{i,t}$  = rate of heat radiated from the lights and absorbed by surface i at time t  
 $RE_{i,t}$  = rate of heat radiated from equipment and occupants and absorbed by surface i at time t

The equations governing conduction within the six slabs cannot be solved independent of the above equations since the energy exchanges occurring within the room affect the inside surface conditions which in turn affect the internal conduction. Consequently, one is faced with solving six equations simultaneously with the governing equations of conduction within six slabs in order to calculate the cooling load at time of interest ( $Q_{L,t}$ ) which would be given by:

$$\begin{aligned}
 Q_{L,t} = & \sum_{i=1}^6 h_{ci} (t_{i,t} - t_{a,t}) + \rho C G_{L,t} (t_{o,t} - t_{a,t}) \\
 & + \rho C G_{V,t} (t_{v,t} - t_{a,t}) + RS_{a,t} + RL_{a,t} + RE_{a,t}
 \end{aligned}$$

where

- $\rho$  = air density  
 $C$  = air specific heat  
 $G_{L,t}$  = mass flow rate of outdoor air infiltrating into the space at time t  
 $t_{o,t}$  = outdoor air temperature at time t



- $G_{v,t}$  = mass rate of flow of ventilation air at time  $t$
- $t_{v,t}$  = ventilation air temperature at time  $t$
- $RS_{a,t}$  = rate of solar heat coming through the windows and convected into the room air at time  $t$
- $RL_{a,t}$  = rate of heat from the lights convected into the room air at time  $t$
- $RE_{a,t}$  = rate of heat from equipment and occupants and convected into the room air at time  $t$

A rigorous approach such as this for calculating cooling load would be practically impossible if it were not for the speed at which such computations can be done by modern digital computers. Even so, there are very few computer programs in use today where instantaneous cooling loads are calculated in this exact manner. The concept, however, has been presented previously by Stephenson and Mitalas<sup>3/</sup>, and by Buchberg<sup>4/</sup>.

Not to be ignored is the effect of air temperature deviation from some prescribed set point. This set point is the temperature for which the cooling (heating) load calculation is made and for which the design capacity of the cooling (heating) apparatus is usually selected. A recent study by Mitalas and Stephenson<sup>5/</sup> shows that actual heat extracted from the space is considerably smaller than the cooling load calculated on the basis of a constant space temperature. This is due to the thermal storage effect of the building structure and internal furnishings. Figure 1 shows a result from that study and as can be seen, the calculated cooling load peaks at values considerably higher than the measured heat extraction rate.

75  
50  
25  
0  
WATT/FT<sup>2</sup>

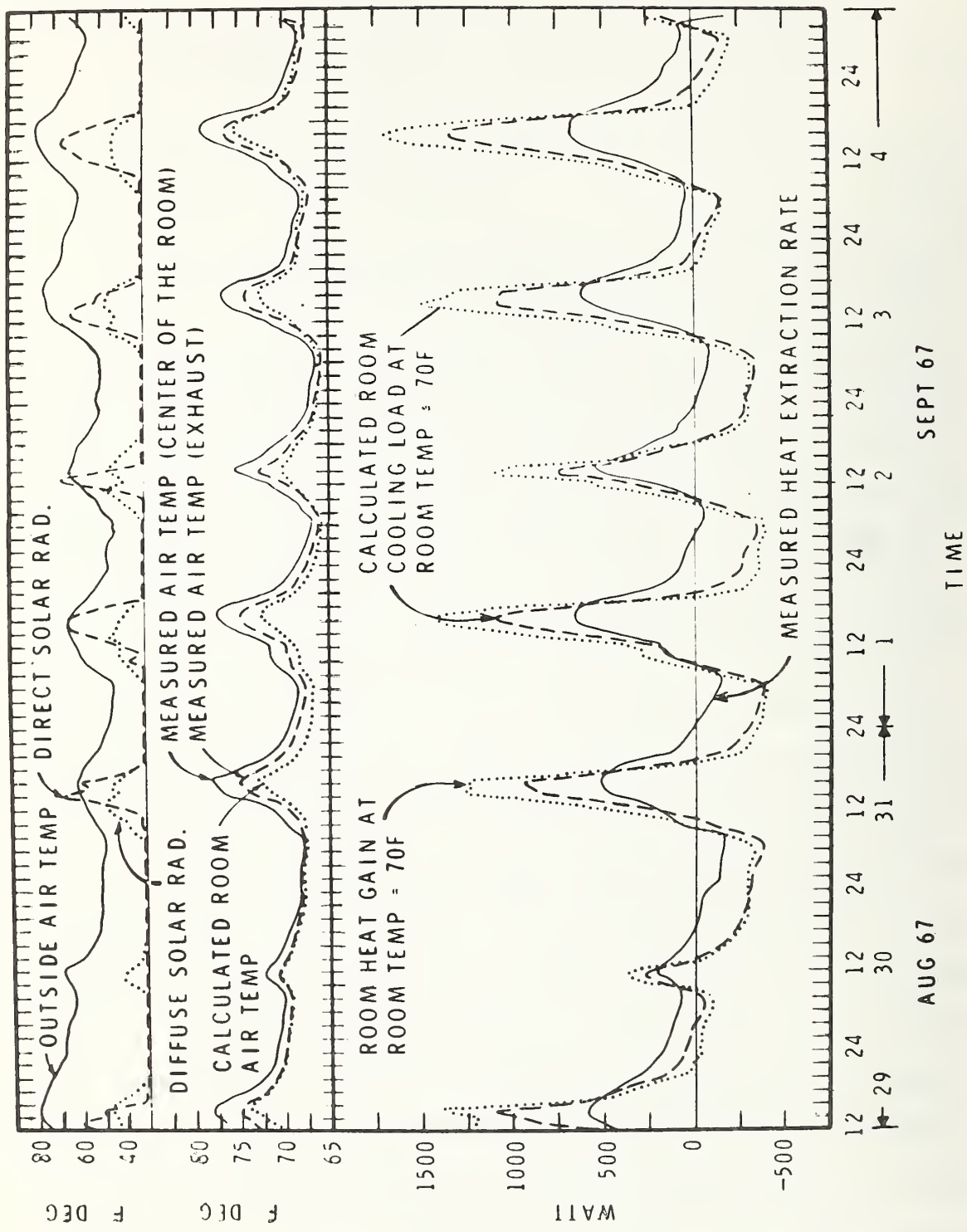

Figure 1 Measured and Calculated Thermal Performance in an Ottawa Office Building (Reference 4)

## 2.2 Approximate Methods of Calculating Heating and Cooling Loads

Since the exact solution technique is extremely time consuming especially for the calculations done for a period of 8760 hours (one year), the ASHRAE Task Group on Energy Requirements recommends a transfer function concept to simplify the calculation procedure. The transfer function concept was first introduced by Mitalas and Stephenson<sup>3/</sup> using what they called room thermal response factors. Their procedure is as follows: the room surface temperatures and cooling or heating load are first calculated by a rigorous method as described in the previous section for several typical constructions representing offices, schools and dwellings of heavy, medium and lightweight construction. In these calculations, the components such as solar heat gain, conduction heat gain, or the heat gain from the lighting, equipment, and occupants are simulated by pulses of unit strength. The transfer functions are then calculated as numerical constants which represent the cooling load (or heating) corresponding to the input excitation pulses. Once these transfer functions are determined for a number of typical constructions, they are assumed to be independent of input pulses and the determination of cooling loads (or heating) is possible without resorting to the rigorous calculations. The calculation required is, instead, simple multiplication of the transfer functions by a time-series representation of heat gain and the subsequent summation of these products, which can be carried out on a small computer with little effort.

Another way to shorten the computational effort for energy calculations is to determine regression parameters by fitting a simple algebraic equation to the results of rigorous calculations, which had been obtained not for an entire year but for a limited period in the year, such as for the months of January and/or July. Once this regression equation is determined with sufficient accuracy, an energy estimate is made by superimposing the weather conditions of the other months onto the relationships just determined.

An example of this approach is illustrated in Figure 2, which depicts the daily total heating and cooling load plotted against the daily average outdoor air temperature. This plot is a result of a lengthy rigorous calculation performed on a typical apartment in Jersey City using the annual hourly weather conditions that occurred in 1949. The straight lines superimposed on the figures were the least square regression lines that best fit the calculated loads for January and July. It was clear from this figure that the exact calculations for other months would not be necessary, at least for the purpose of determining daily loads, since the regression relationship determined from the January and July calculations were sufficiently accurate that they could be extrapolated to the remainder of the year.

Depending upon the type of building and its heating and cooling system, a good correlation such as illustrated in Figure 2 may not be possible. Figure 3 shows, for example, a similar plot for a test office building whose heating and cooling load were measured in a research project conducted by Ohio State University. The scatter appears considerably larger than the calculated relationship obtained in the Jersey City study.



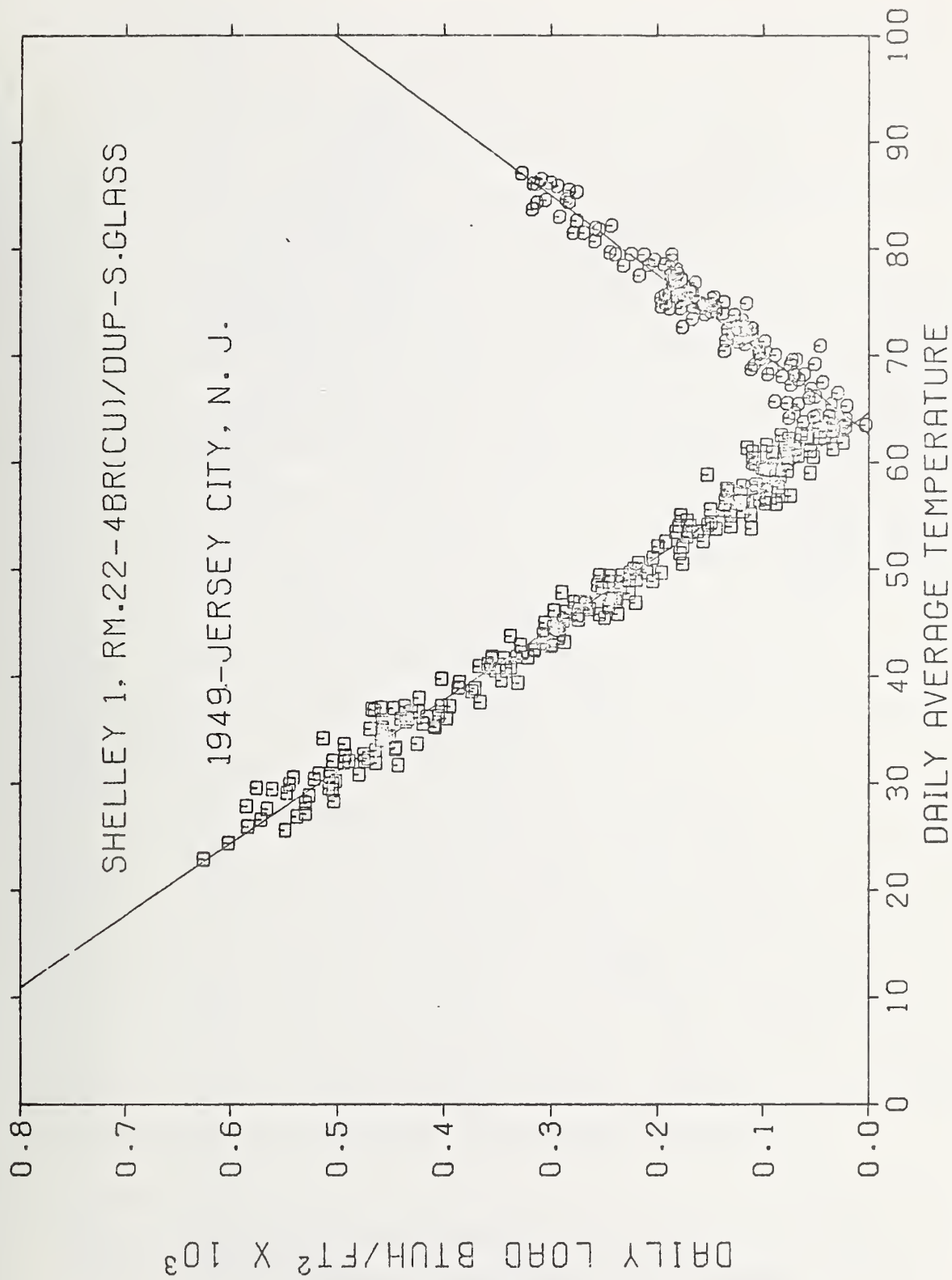

Figure 2 Calculated Daily Total Thermal Loads of a Jersey City Apartment Plotted Against Daily Average Temperatures

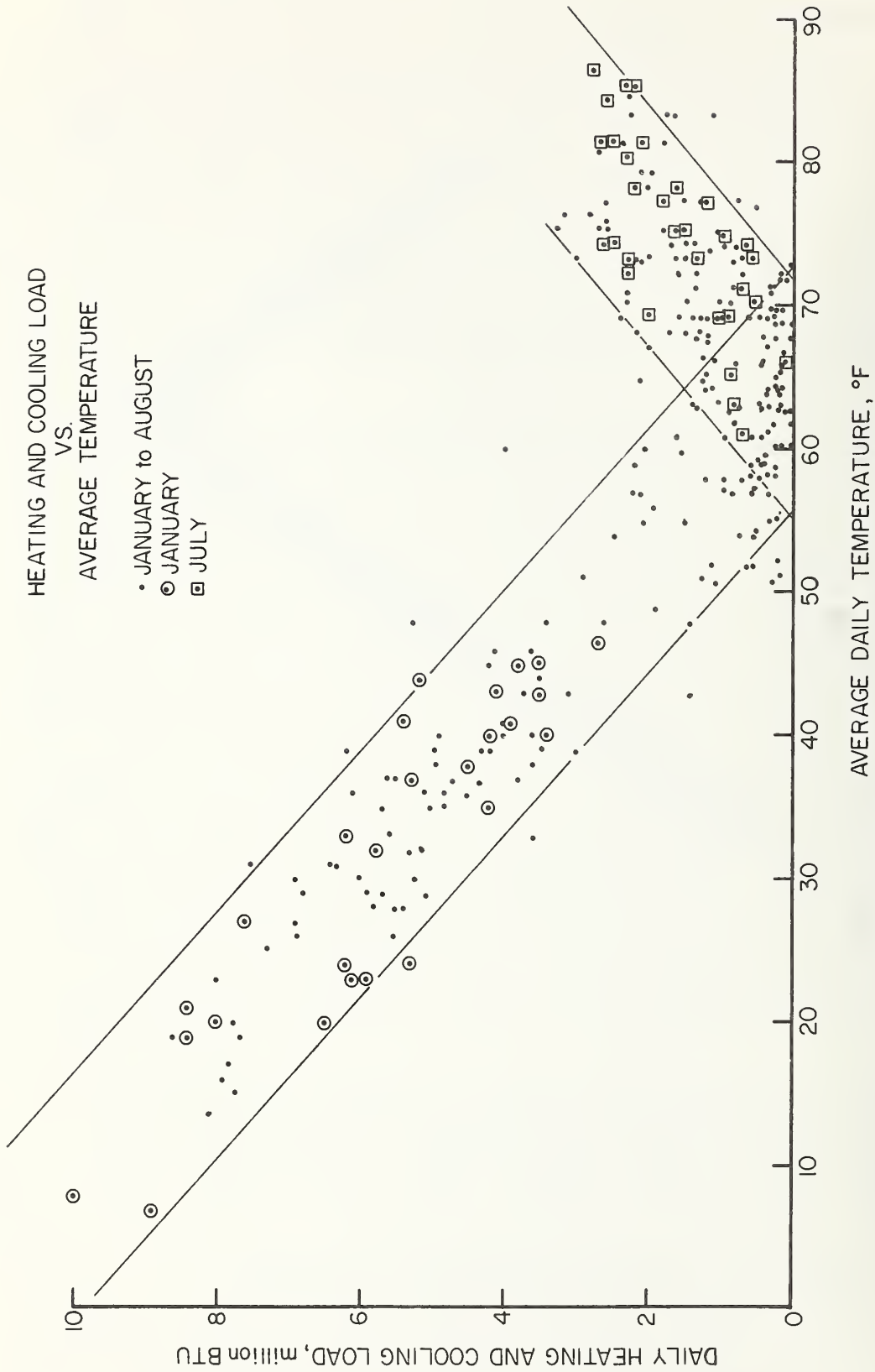

Figure 3 Measured Daily Total Thermal Loads of a Columbus Law Building Plotted Against Daily Average Temperatures



It is obvious that the thermal performance of commercial buildings are affected in a large way by the manner in which internal heat is generated in addition to the normal dependence on outdoor temperature. The inclusion of one or more additional statistical parameters dealing with these internal heat gains should improve the correlation.

Recently one additional method of predicting the heating and/or cooling load or the indoor temperature as a result of the excitation parameters such as outdoor temperature, solar radiation and internal heat generation has been demonstrated by Kusuda and Tsuchiya<sup>6/</sup> and further expanded by Kimura and Ishino<sup>7/</sup>. The method uses the concept of equivalent thermal mass of a building and attempts to fit the observed input and output data into a linear differential equation. The initial results are promising. Figure 4 shows a comparison of predicted and measured room temperature and heat extraction rate for a simple one room test building studied by Kimura and Ishino.

Calculated room temperature in Figure 4 is obtained by the transfer functions derived from the measured data of August 19, while the heat extraction was calculated by the transfer functions derived from the measured values of August 13. The good agreement indicated in Figure 4 implies that the detailed calculation is needed only for a limited number of days to derive accurate transfer functions based upon the equivalent thermal mass of the particular building under consideration.

---

\* Private communication with Professor C. F. Sepsey and J. Jones of the Ohio State University.

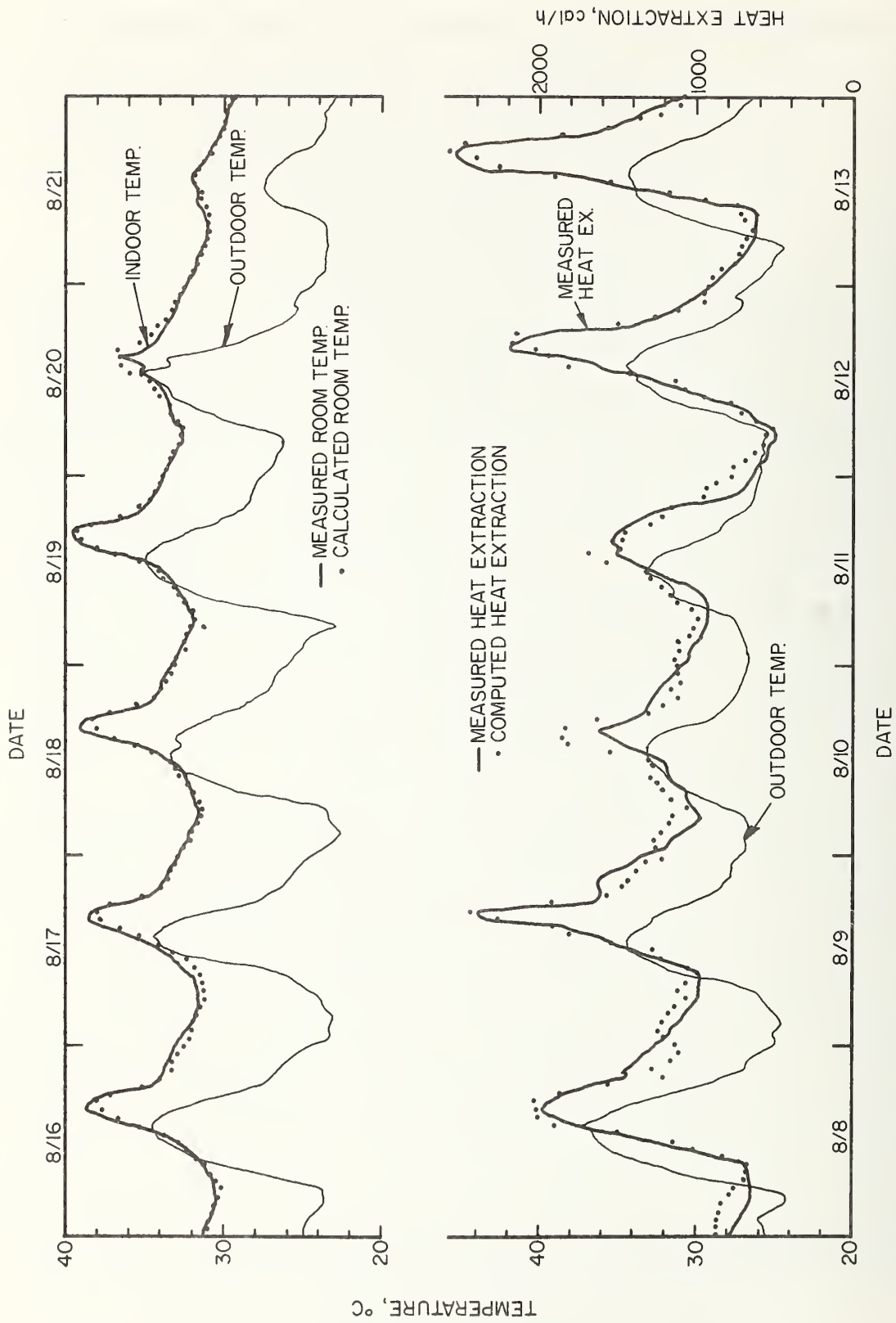

Figure 4 A Comparison of Measured and Calculated Thermal Performance of an Experimental Building (Courtesy of Professor K. Kimura)

### 3. Unique Features of NBS Load Calculation Computer Program

A comprehensive yet easy-to-use computer program for determining heating and cooling loads has been developed in the Thermal Engineering Section of the Center for Building Technology at the National Bureau of Standards. This computer program is based upon extensive information accumulated over the past decades in various phases of building heat transfer problems, and is intended to be used for the design of equipment and air conditioning systems as well as for estimates of building energy requirements.

The major reason why NBS developed this comprehensive program is that despite the existence of numerous load calculation programs currently available, most of them are not suitable for the analysis of building designs where non-conventional or innovative ideas on structures, heating and cooling systems and controls are employed. Some of the unique aspects of building and system design and operation that can be handled by or studied by using NBSLD are:

1. Inside-out construction of exterior walls where the thermal insulation is placed on the outside of the building shell as opposed to conventional walls having insulation on the inside. (These two walls could have the same U-value and yet their thermal response would be quite different.)
2. Effect of interior partition walls or floor-ceiling sandwich structures on the heat storage characteristics of the room,

3. Off-peak heating or cooling of buildings to shave the peak heating or cooling demand,
4. Evaluation of intentionally undersized heating and cooling equipment by calculating the room temperature and humidity deviations from a design set point. (The results would indicate whether or not the indoor conditions would remain within acceptable limits.)
5. Evaluation of indoor thermal environment of various zones during the intermediate season, such as spring and autumn, when the heating or cooling requirements for these zones may not be in phase with that of the building as a whole. (This would apply to a case where a two-pipe system would be installed for example. The central system for the entire building might be switched to heating in late autumn and yet some zones, particularly those facing south may still require cooling. NBSLD can be used to determine the indoor thermal conditions of unheated or uncooled rooms.)
6. Use of solar energy for heating and cooling buildings as it relates to the thermal storage characteristics of the building,
7. Use of attic ventilation to reduce the cooling load since NBSLD can accurately predict attic temperatures,
8. Accurate determination of the need for heating and air conditioning in basement rooms,



9. Design of heating and cooling systems and equipment on the basis of intermittent operation, such as the shutdown of air conditioning facilities during the nighttime or weekends,
10. Effective use of natural air conditioning such as ventilation, shading, increased ceiling insulation and the subsequent determination of the requirements for mechanical cooling,
11. Effective use of planned ventilation to minimize a building heating load during the winter season,
12. Accurate evaluation of indoor comfort conditions based upon air temperature, humidity and mean-radiant temperature,
13. Determination of the condition whereby moisture condensation takes place along interior surfaces of a building.

Figure 5 depicts an overall calculation sequence to attain the hour by hour heating and cooling load of buildings. Shown in the double lined boxes are input data to be supplied whereas those in single lined boxes indicate calculations to be performed. The cycle indicators show the iteration cycles for the number of buildings, the number of rooms in a given building and the number of days for which the calculations are performed. More specific identification of the types of input data needed are listed in Figures 6, 7 and 8. The exact way the input data is put into the program is specified in Appendix C.

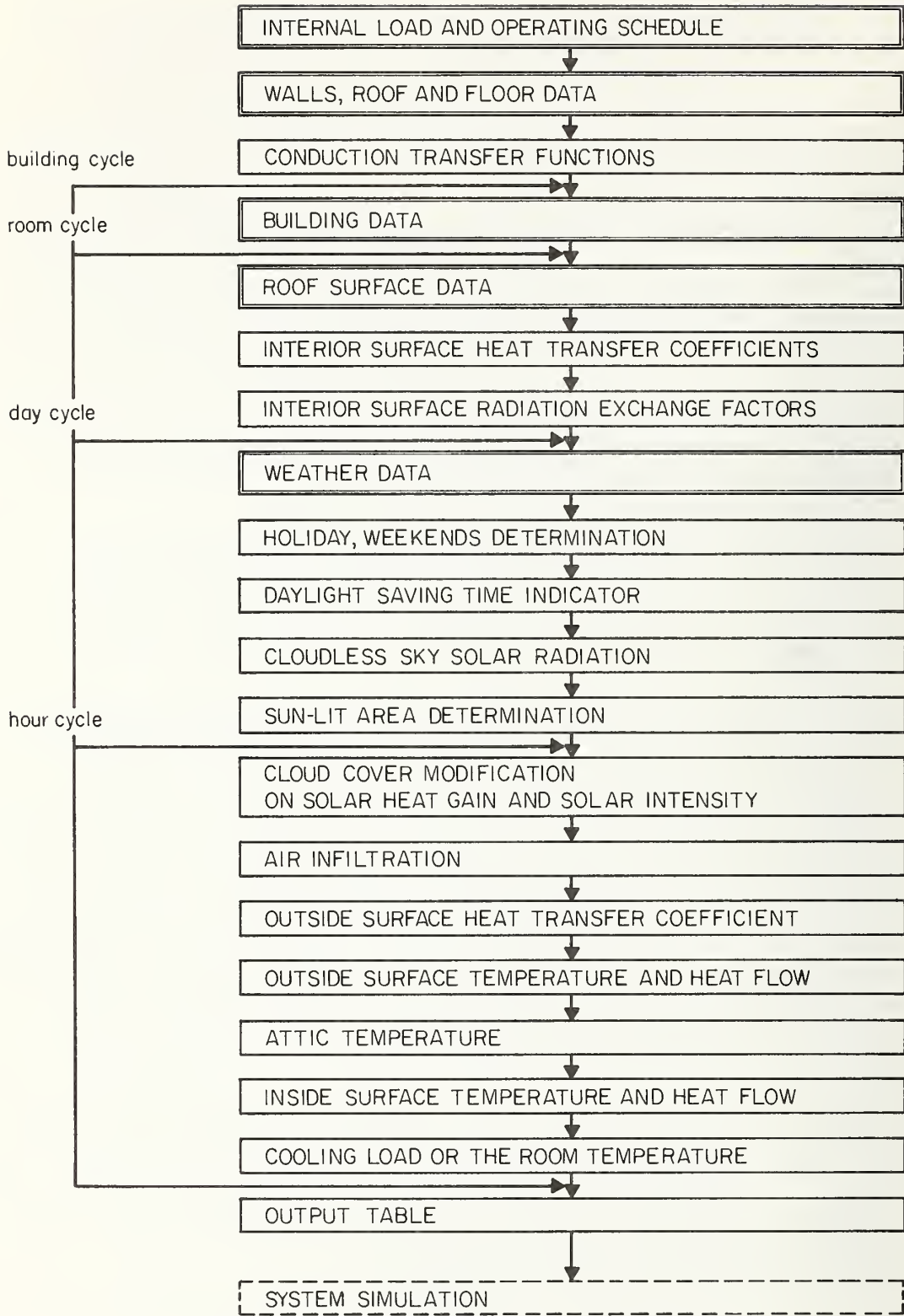

Figure 5 Calculation Sequence of NBSLD



INPUT - OPERATING DATA

- ELECTRIC POWER TO LIGHTS, WATTS PER SQUARE FOOT OF FLOOR (QLITY)
- HOUR BY HOUR LIGHTING SCHEDULE (QLITX)
- ELECTRIC POWER TO EQUIPMENT, WATTS PER SQUARE FOOT OF FLOOR (QEQPX)
- HOUR BY HOUR EQUIPMENT SCHEDULE (QEQUX)
- SUPPLY AIR RATE (CFMS)
- AIR LEAKAGE RATE (CFML)
- SUPPLY AIR TEMPERATURE (TS)

Figure 6

## INPUT - BUILDING DATA

- ROOM NUMBER (ROOMNO)
- CEILING HEIGHT (H)
- ROOM LENGTH (L)
- ROOM WIDTH (W)
- NUMBER OF OCCUPANTS (QCU)
- OCCUPANT SCHEDULE (QOCUP)
- WINTER WINDOW OVERALL HEAT TRANSFER COEFFICIENT (UGLAS)
- GROUND FLOOR HEAT TRANSFER COEFFICIENT (UG)
- SUMMER INFILTRATION, AIR CHANGES PER HOUR (ARCHGS)
- WINTER INFILTRATION, AIR CHANGES PER HOUR (ARCHGW)
- TYPE OF HEAT TRANSFER EXPOSURES (ITYPE)  
-ROOFS-WALLS-WINDOWS-DOORS-FLOORS
- TYPE OF RESPONSE FACTORS TO BE USED (IRF)  
-HEAVY/LIGHT: ROOF, EXTERIOR WALLS, CEILING/FLOOR  
PARTITION
- U VALUE OF THE EXPOSURE (U) (ONLY WHEN RESPONSE FACTOR  
IS NOT CALCULATED)
- AREA OF THE EXPOSURE (A)
- ORIENTATION OF THE EXPOSURE (AZW) -N,E,S,W (ONLY FOR  
EXTERNALLY EXPOSED SURFACES)
- WINDOW SHADING COEFFICIENT (SHADE)
- SOLAR HEAT ABSORPTION COEFFICIENT FOR THE EXTERIOR SURFACE  
(ABSP)
- TIME INCREMENT OF TEMPERATURE DATA USED
- PROPERTIES OF BUILDING MATERIALS - THICKNESS - THERMAL  
CONDUCTIVITY - DENSITY - SPECIFIC HEAT
- NUMBER OF SURFACES IN EACH WALL (NS,NW,NN,NE)

Figure 7

INPUT - WEATHER DATA

- LATITUDE (LAT)
- LONGITUDE (LONG)
- TIME ZONE NUMBER (TZN)
- MONTH (MONTH)
- DAY (DAY)
- ELAPSED DAYS SINCE JANUARY 1 (ELAPS)
  
- MAXIMUM TEMPERATURE OF THE DESIGN DAY (DBMAX)
- DAILY TEMPERATURE RANGE OF THE DESIGN DAY (RANGE)
- DESIGN INDOOR TEMPERATURE CONDITION (DBIN)
- DESIGN OUTDOOR WET-BULB TEMPERATURE (WBMAX)
- DESIGN INDOOR WET-BULB TEMPERATURE (WBID)
- DESIGN WINTER OUTDOOR TEMPERATURE (DBMWT)
- DESIGN SUMMER GROUND TEMPERATURE (TG)
- DESIGN WINTER GROUND TEMPERATURE (TGW)

Figure 8

#### 4. General Description of NBSLD Subroutines

In order to perform the chain of calculations depicted in Figure 5, a number of subroutines were developed at the National Bureau of Standards, the algorithms of which have already been published through the ASHRAE Task Group booklet entitled "Procedure for Determining Heating and Cooling Loads for the Computerized Energy Calculations". This booklet, however, contained several errors which have been corrected and is attached to this report as Appendix A. NBSLD incorporates most of the revised ASHRAE algorithms as they are written; however, some of them have been combined or split to fit the overall computational scheme in NBSLD. Listed below is a brief description of the NBSLD subroutines with their specific reference to the ASHRAE algorithms in parentheses.

1. ABCD, ABCDP, ABCD2, ABCDP2, DERVT, GPF, MULT, RESF, RESFX, RESPTK: These routines are parts of the conduction transfer functions calculation package and are needed for the accurate evaluation of thermal time lag, damping, heat storage in exterior facing surfaces as well as the internal furnishings. (XYZ)
2. AIRCON: This routine is used to determine instantaneous values of the physiological indices for the space being studied such as ASHRAE's New Effective Temperature, Predicted Mean Vote (Fanger), Heat Stress Index, KSU Index, Resultant Temperature, Operative Temperature, and Index of Thermal Stress (Givoni). - not included in the text

3. ATTIC: Attic space temperature and heat conduction through the ceiling into the room below are calculated by this routine for the vented or non-vented attics. (ATTIC)
4. CCM: This routine modifies the solar radiation computed for a cloudless sky by instantaneous cloud cover data. (CCF)
5. DPF: This routine calculates dew point temperature of atmospheric air when the partial vapor pressure is known. (PSY)
6. DST: This routine determines whether a given data is in a daylight saving time zone. The information is needed for the proper assignment of the energy usage schedule. (DST)
7. FCTR: This routine determines radiation exchange factors between any two surfaces which are part of a given room. For the room of six interior surfaces, for example, thirty radiation exchange factors are calculated. These factors are used in turn to determine the rate of heat exchange by radiation between all the interior surfaces. (FIJ)
8. F: This routine calculates radiation heat exchange factors (form factors) between two adjacent rectangular surfaces which are normal to each other, such as that between the floor and wall. (FIJ)



9. FO: This routine calculates the surface heat transfer coefficients for externally exposed surfaces from weather data. (FO)
10. GLASS: This routine calculates solar heat gain through glass when the shading coefficient, orientation, and type of glass are given. (SHG)
11. HOLIDAY: This routine identifies the national holidays in the United States so that the proper holiday schedule can be used for the energy calculation. (HOLIDAY)
12. OUTSID: This routine calculates the outside surface temperature and heat gain into the wall or roof by taking into account solar heating, back radiation to the sky, convective heat loss to the ambient air and transient heat conduction within the wall or roof. (HEATW)
13. PSY1: This is a psychrometric routine that determines the thermodynamic properties of moist air when the dry-bulb temperature, wet-bulb temperature and barometric pressures are given. (PSY)
14. PSY2: This routine is similar to PSY1 except that the dew point temperature is required instead of the wet-bulb temperature. (PSY)
15. PVSF: This routine determines the saturated vapor pressure of atmospheric air as a function of temperature. (PSY)

16. RMTMP: This is the single most important subroutine of NBSLD since it determines the room temperature by solving matrix equations expressing a balance of heat gains, heat storage at the room surfaces, and cooling capacity of an air conditioning unit. However, the room temperature can be prescribed, in which case the routine will calculate the heating/cooling requirements to satisfy that prescribed temperature. (RMTMP)
17. ROOM: This routine reads in all the data required for the room heat transfer calculation such as dimensions, surface orientations, shading coefficients, surface solar absorptivity, etc.
18. SHG: This is the routine that calculates solar heat gain through glass. (SHG)
19. SOLVP: This routine solves the simultaneous linear algebraic equations that appear in RMTMP. (RMTMP)
20. SUN: Basic sun data such as solar angles, cloud cover, direct and diffuse radiation needed for solar heat gain and solar heating of the building exterior surfaces are calculated in this routine. (SUN, SOLAD)
21. TAR: This routine calculates transmission and absorption characteristics of glass. (TAR)
22. WBF: This is another psychrometric routine that calculates the wet-bulb temperature when the enthalpy of moist air and the barometric pressure are specified. (PSY)

23. WKDAY: This subroutine determines the day of week when the date and year are given. The information is needed for the proper selection of energy usage schedules which are dependent upon whether the day is a weekday or not.

(WKDAY)

24. WD, WDX, DECODE, ERROR, WEATHE: The weather data tape 1440 supplied by the National Climatic Center, Asheville, N. C. is prepared in a format which cannot be readily applicable in most of the Fortran programs. These routines are therefore necessary to read the 1440 tapes and decode them into meaningful weather parameters, which in turn can be used by UNIVAC 1108 Fortran of the National Bureau of Standards. If there are some data which are unreasonable, the data will be replaced by the arithmetic average of two adjacent data by the ERROR routine. (CLIMAT)

All the subroutines in the program may be used to form a separate main program for a specific job. Following are sample usages of some of the subroutines.

## 1. Psychrometric Calculation

CALL PSY1 (DB, WB, PB, DP, PV, W, H, V, RH)

where inputs are DB = dry-bulb temperature

WB = wet-bulb temperature

PB = barometric pressure

outputs are DP = dew point temperature

PV = vapor pressure

W = humidity ratio

H = enthalpy

V = volume

RH = relative humidity

There is also a routine called PSY2 (DB, DP, PB, WB, PV, W, H, V, RH) in which the inputs are DB, DP and PB instead of DB, WB and PB. In many cases DB and RH are the inputs and the vapor pressure and dew point temperature or the wet-bulb temperature at standard barometric pressure are the outputs. A possible algorithm that could be desired, for example, might be:

PVS = PVSF (DB)

PV = PVS\*RH/100

DP = DPF (PV)

Call PSY2 (DB, DP, PB, WB, PV, W, H, V, RH)

## 2. Solar Radiation

Recently there has been increased interest in the application of solar energy for heating of hot water. SUN and GLASS routines should be valuable for evaluating various solar collectors at different locations in the United States at different times of the year. A sample use of these routines may be shown for a solar collector having the following characteristics (Figure 9)

location: latitude =  $45^\circ$ , longitude =  $73^\circ$

azimuth angle =  $0^\circ$  south

tilt angle =  $30^\circ$  from horizontal surface

area =  $500 \text{ ft}^2$

date = July 21

time = 4:00 p.m.

glass cover = double sheet - clear glass

$U_R$  = overall heat transfer coefficient between the collector surface and the ambient,  $\text{Btu/hr ft}^2 \text{ }^\circ\text{F}^*$

$U_W$  = overall heat transfer coefficient between the collector surface and water, which is being circulated under the collector plate,  $\text{Btu/hr ft}^2 \text{ }^\circ\text{F}$

TWI = water temperature entering the collector,  $^\circ\text{F}$

TWL = water temperature leaving the collector,  $^\circ\text{F}$

GPM = water circulation rate in gallons per minute

---

\* When the collector temperature is less than  $150 \text{ }^\circ\text{F}$ , the typical value of  $U_R$  for a flat black collector with double glass cover may be 0.75. The value increases to as much as 1.5 when the collector temperature is in the neighborhood of  $300 \text{ }^\circ\text{F}$ . A special computer program is available for estimating the value of  $U_R$  for various types of collectors.



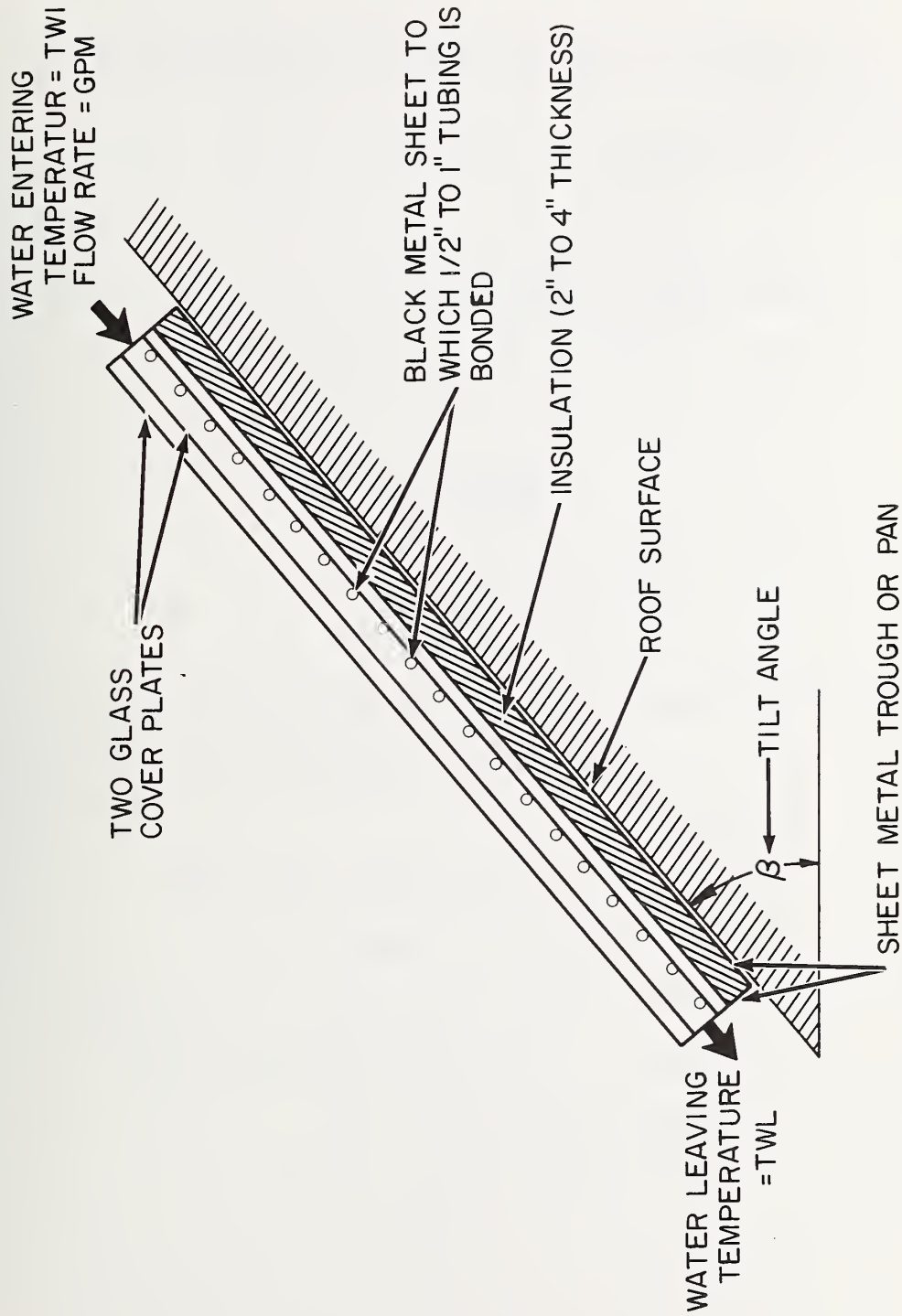

Figure 9 A Typical Flat Plate Solar Collector

It is assumed that the collector is well insulated around the edges and its bottom.

The algorithm for the use of SUN and GLASS routines would then be:

S(1) = LATITUDE = 30

S(2) = LONGITUDE = 73

S(3) = Time zone number = 5

S(4) = Elapsed days since January 1 = 202

S(5) = Time = 16

S(6) = IDST = daylight saving time index = 1

S(7) = Ground reflectivity = 0.2

S(8) = Clearness number = 1.0

S(33) = Cloud cover modifier = 1

S(9) = Azimuth angle of the collector = 0°

S(10) = Tilt angle of the collector = 30°

Call SUN

Call GLASS (SHDW, SHADE, GLASTP, GLAZE, SHG)

note: SHDW = sunlit area factor = 1

SHADE = shading coefficient = not applicable

GLASTP = 1/8" double strength glass (1)

GLAZE = double glazing (2)

SHG = solar heat gain - output

note: SUN and GLASS have S in common using the solar heat gain through the glass plate. When the edge heat loss is small, the following calculation may be used to estimate TS, collector surface and TWL, leaving water temperature from the collector:

$$TS = \frac{A*(SHG + UR*DB) + 500*GPM*TWI*Y}{UR*A + 500*GPM*Y}$$

where  $Y = 1 - e^{-X}$

where  $X = \frac{U_w*A}{500*GPM}$

## 5. NBSLD Logic Diagram

Figure 10 shows the way in which the various subroutines of NBSLD fit together in the usage of the program.

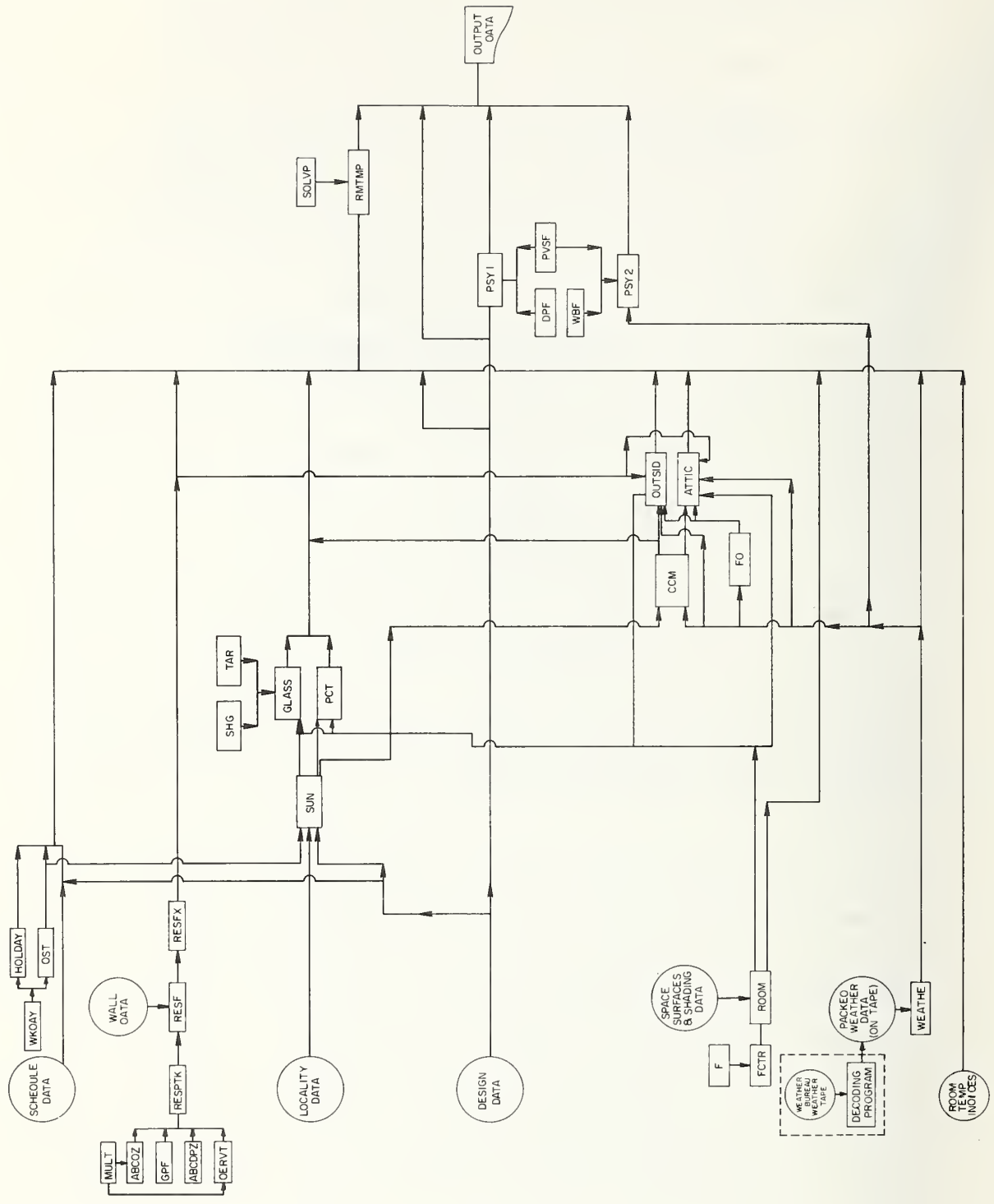

Figure 10 Interrelationship of Various Subroutines for NBSLD

## 6. References

1. "Pattern of Energy Consumption in the United States", Stanford Research Institute Report, pp. 6-7, January 1972.
2. "Heating Load" and "Air-Conditioning Cooling Load", ASHRAE Handbook of Fundamentals, Chapters 21 and 22, pp. 375-445, 1972.
3. Mitalas, G. P. and Stephenson, D. G., "Room Thermal Response Factors", ASHRAE Transactions, 1967, Vol. II, pp. III 2.1-2.10.
4. Buchberg, H., "Sensitivity of the Thermal Response of Buildings to Perturbations in the Climate", Building Science, Vol. 4, pp. 43-61, Pergamon Press, 1969.
5. Mitalas, G. P., "An Experimental Check on the Weighting Factor Method of Calculating Room Cooling Load", ASHRAE Transactions, 1969, pp. 222-232.
6. Kusuda, T., Tsuchiya, T. and Powell, F. J., "Prediction of Temperature by Using Equivalent Thermal Mass Response Factors", Proceedings of the 5th Symposium on Temperature, National Bureau of Standards, 1971.
7. Kimura, K. and Ishino, H., "Air Conditioning Load Calculation by the Equivalent Mass Weighting Factor Method for the Computerized Control", Proceedings of the Japanese Architectural Society, pp. 249-250, Kyushu meeting, October 1972 and Proceedings for the Second Symposium on the Use of Computers for Thermal Engineering Related to Buildings, COSTIC, 1974.





7. Appendix A

Subroutine Algorithms Prepared for the  
ASHRAE Task Group on Energy Requirements



## CLIMAT

### A Procedure for Obtaining Climatic Weather Data

Climatic parameters needed for the hourly load calculations are:

- DB: Dry-bulb temperature, F
- DP or WB: Dew point or wet-bulb temperature, F
- CT: Cloud type
- TC: Total cloud amount
- V: Wind speed, knots
- DIR: Wind direction (clockwise from North), degrees
- PB: Barometric Pressure, in. Hg
- ID: Direct Solar Radiation, Btu per (hr) (sq ft)
- $I_{d,sky}$ : Sky diffuse radiation, Btu per (hr) (sq ft)
- $I_{d,ground}$ : Ground diffuse radiation, Btu per (hr) (sq ft)
- Rain, Snowfall: Precipitation data (Optional)

Hourly observations of these weather parameters for past years are available from the National Climatic Center either on magnetic tape or in card deck form. The hourly solar radiation data has been recorded for only approximately fifty stations throughout the United States (Table A-1). These data are, moreover, limited in their durations and completeness, and scarcely useful for the comprehensive energy analysis. On the other hand, the data series 144 includes the hourly observations of all of the parameters listed above except the solar radiation for more than 300 weather stations (Table A-2) covering a period of from ten to thirty years. Since the 144 series data are very much complete, it is

recommended that hour by hour energy calculations be made with this series of data supplemented by simulated solar radiation data. A method for simulating solar radiation will be described later in this booklet.

Because of the specific coding scheme employed by the National Climatic Center for storing the hourly weather data onto the magnetic tapes, the 144 series is not directly usable by the standard Fortran programs. Different computing systems such as IBM 370, CDC 6600 and UNIVAC 1108 have their own decoding routines to read these tapes. Included in this section is a listing of a Fortran program which illustrates a decoding scheme required to make use of the weather tapes. This listing was prepared by Mr. McKay, Data Reduction Section, of the National Climatic Center, Asheville, North Carolina.

For further information on the procurement of weather tapes and possible assistance in decoding, the following office may be contacted:

Mr. G. McKay or D. Calloway  
National Climatic Center  
Applied Climatology Division  
Federal Building  
Asheville, North Carolina 28801  
Tel. (704) 254-0961 x203



Table A-1 Solar Radiation Data

Albuquerque, New Mexico	Lake Charles, Louisiana
Apalachicola, Florida	Lake Charles, Louisiana
Barrow, Alaska	Lincoln, Nebraska
Bethel, Alaska	Lincoln, Nebraska
Bismark, North Dakota	Los Angeles, California
Blue Hill/Milton, Massachusetts	Madison, Wisconsin
Boston, Massachusetts	Matanuska, Alaska
Brownsville, Texas	Medford, Oregon
Canton Island	Miami, Florida
Cape Hatteras, North Carolina	Nashville, Tennessee
Caribou, Maine	New York, New York
Charleston, South Carolina	Oak Ridge, Tennessee
Cleveland, Ohio	Omaha, Nebraska (North Omaha)
Columbia, Missouri	Phoenix, Arizona
Dodge City, Kansas	Riverside, California
El Paso, Texas	Santa Maria, California
Ely, Nevada	Santa Maria, California
Fairbanks, Alaska	Sault Ste. Marie, Michigan
Fort Worth, Texas	Seattle, Washington
Fort Worth, Texas	Sterling, Virginia
Fresno, California	Tucson, Arizona
Grand Lake/Granby, Colorado	Upton, New York
Great Falls, Montana	Wake Island
Hatteras, North Carolina	Washington, D. C.
Inyokern, California	

Table A-2

U.S. DEPARTMENT OF COMMERCE  
 NATIONAL OCEANIC AND ATMOSPHERIC ADMINISTRATION  
 ENVIRONMENTAL DATA SERVICE

Stations for which Local Climatological Data are issued, as of January 1, 1972

abc	ALABAMA		FLORIDA		MASSACHUSETTS		NEW YORK (Contd.)		SOUTH DAKOTA
abc	Birmingham	ac	Apalachicola	abc	Boston	abc	Buffalo	abc	Aberdeen
abc	Huntsville	abc	Daytona Beach	ac	Blue Hill Obs.	abc	New York	abc	Huron
abc	Mobile	abc	Fort Myers	abc	Worcester	abc	Central Park	abc	Rapid City
abc	Montgomery	abc	Jacksonville	abc		abc	J. F. Kennedy Int'l AP	abc	Sioux Falls
		abc	Key West			abc	LaGuardia Field		
	ALASKA	ac	Lakeland	abc	MICHIGAN	abc	Rochester		TENNESSEE
abc	Anchorage	abc	Miami	abc	Alpena	abc	Syracuse	abc	Bristol
abc	Annette	abc	Orlando	abc	Detroit	abc		abc	Chattanooga
abc	Barrow	abc	Pensacola	abc	City Airport	abc		abc	Knoxville
abc	Barter Island	abc	Tallahassee	abc	Detroit Metro AP	abc	NORTH CAROLINA	abc	Austin
abc	Bethel	abc	Tampa	abc	Grand Rapids	abc	Asheville	abc	Memphis
abc	Bettles	abc	West Palm Beach	abc	Houghton Lake	abc	Cape Hatteras	abc	Nashville
abc	Big Delta			abc	Lansing	abc	Charlotte	abc	Oak Ridge
abc	Cold Bay		GEORGIA	ac	Marquette	abc	Greensboro	a	Area Stations
abc	Fairbanks	abc	Athens	abc	Muskegon	abc	Raleigh	abc	City
abc	Gulkana	abc	Atlanta	abc	Sault Ste. Marie	abc	Wilmington		
abc	Homer	abc	Augusta						TEXAS
abc	Juneau	abc	Columbus		MINNESOTA	abc	NORTH DAKOTA	abc	Abilene
abc	King Salmon	abc	Macon	abc	Duluth	abc	Bismarck	abc	Amarillo
abc	Kotzebue	ac	Rome	abc	International Falls	abc	Fargo	abc	Austin
abc	McGrath	abc	Savannah	abc	Minneapolis-St. Paul	abc	Williston	abc	Brownsville
abc	Nooe			abc	Rochester	abc		abc	Corpus Christi
abc	St. Paul Island		HAWAII	abc	St. Cloud	abc	OHIO	abc	Dallas
abc	Shemya	abc	Hilo	abc		abc	Akron-Canton	abc	Del Rio
abc	Summit	abc	Honolulu	abc	MISSISSIPPI	ac	Cincinnati	abc	El Paso
abc	Talkeetna	abc	Kahului	abc	Jackson	abc	Abbe Obs.	abc	Fort Worth
abc	Unalakleet	abc	Lihue	abc	Meridian	abc	Airport	ac	Galveston
abc	Yakutat			abc		abc	Cleveland	abc	Houston
				abc	MISSOURI	abc	Columbus	abc	Lubbock
	ARIZONA	abc	IDAHO	abc	Columbia	abc	Dayton	abc	Midland
abc	Flagstaff	abc	Boise	abc	Lewiston	abc	Mansfield	abc	Port Arthur
abc	Phoenix	abc	Pocatello	abc	Kansas City	abc	Toledo	abc	San Angelo
abc	Tucson			abc	St. Joseph	abc	Youngstown	abc	San Antonio
abc	Winslow		ILLINOIS	abc	St. Louis	abc		abc	Victoria
abc	Yuma	ac	Cairo	abc	Springfield	abc	OKLAHOMA	abc	Waco
			Chicago	abc		abc	Oklahoma City	abc	Wichita Falls
			Midway Airport	abc	NEBRASKA	abc	Tulsa		
abc	ARKANSAS	abc	O'Hare Airport	abc	Billings	abc			UTAH
abc	Fort Smith	abc		abc	Glasgow	abc	OREGON	ac	Milford
abc	Little Rock	abc	Moline	abc	Great Falls	abc	Astoria	abc	Salt Lake City
		abc	Peoria	abc	Havre	abc	Burns	abc	Wendover
	CALIFORNIA	abc	Rockford	abc	Helena	abc	Eugene		VERMONT
abc	Bakersfield	abc	Springfield	abc	Kalispell	abc	Meacham	abc	Burlington
abc	Bishop			abc	Miles City	abc	Medford		
ac	Blue Canyon		INDIANA	abc	Missoula	abc	Pendleton		
ac	Eureka	abc	Evansville	abc		abc	Portland		VIRGINIA
abc	Fresno	abc	Fort Wayne	abc	NEBRASKA	abc	Salem	abc	Lynchburg
abc	Long Beach	abc	Indianapolis	abc	Grand Island	abc	Sexton Summit	abc	Norfolk
abc	Los Angeles Airport	abc	South Bend	abc	Lincoln	ac		abc	Richmond
ac	Los Angeles			abc	Norfolk	abc		abc	Roanoke
	CIVIC CENTER		IOWA	abc	North Platte	abc	PACIFIC ISLANDS	abc	Wallops Island
abc	Mt. Shasta	abc	Burlington	abc	Omaha	abc	Guam	abc	
abc	Oakland	abc	Des Moines	abc	Scottsbluff	abc	Johnston	abc	
abc	Red Bluff	abc	Dubuque	ac	Valentine	abc	Koror	abc	WASHINGTON
abc	Sacramento	abc	Sioux City	ac		abc	Kwajalein	abc	Olympia
abc	Sandberg	abc	Waterloo		NEVADA	abc	Majuro	abc	Quillayute Airport
abc	San Diego			abc	Elko	abc	Pago Pago	abc	Seattle-Tacoma AP
abc	San Francisco		KANSAS	abc	Ely	abc	Ponape	abc	Spokane
abc	Airport	abc	Concordia	abc	Las Vegas	abc	Truk (Moen)	abc	Stampee Pass
ac	City	abc	Dodge City	abc	Reno	abc	Wake	ac	Walla Walla
abc	Santa Maria	abc	Goodland	abc	Winnemucca	abc	Yap	abc	Yakima
abc	Stockton	abc	Topeka						WEST INDIES
		abc	Wichita		NEW HAMPSHIRE	abc	Allentown	abc	San Juan, P. R.
	COLORADO			abc	Concord	abc	Erie		WEST VIRGINIA
abc	Alamosa		KENTUCKY	ac	Mt. Washington	abc	Harrisburg	abc	Beckley
abc	Colorado Springs	abc	Lexington			abc	Philadelphia	abc	Charleston
abc	Denver	abc	Louisville		NEW JERSEY	abc	Pittsburgh	abc	Elkins
abc	Grand Junction			abc	Atlantic City	ac	Airport	abc	Huntington
abc	Pueblo	abc	LOUISIANA	abc	Airport	abc	City	ac	Parkersburg
	CONNECTICUT	abc	Alexandria	a	State Marina	abc	Scranton		
abc	Bridgeport	abc	Baton Rouge	abc	Newark	abc	Williamsport		WISCONSIN
abc	Hartford	abc	Lake Charles	ac	Trenton			abc	Green Bay
	DELAWARE	abc	New Orleans			ac	RHODE ISLAND	abc	La Crosse
abc	Wilmington	abc	Shreveport		NEW MEXICO	abc	Block Island	abc	Madison
		abc		abc	Albuquerque	abc	Providence	abc	Milwaukee
	DISTRICT OF COLUMBIA	abc	MAINE	abc	Caribou				WYOMING
abc	Washington-National AP	abc	Portland	abc	Roswell	abc	SOUTH CAROLINA	abc	Casper
abc	Washington-Dulles Int'l AP	abc		abc		abc	Charleston	abc	Cheyenne
		abc	MARYLAND	abc		abc	Airport	abc	Lander
		abc	Baltimore	abc	NEW YORK	abc	City	abc	Sheridan
				abc	Albany	abc	Columbia	abc	
				abc	Binghamton	abc	Greenville-Spartanburg	abc	

a. Monthly summary issued.      b. Monthly summary includes available 3-hourly observations.      c. Annual Summary issued.  
 Published if 5 or more available per day.

Subscription Price: Monthly Local Climatological Data \$2.00 per year including annual Summary if published. Single copy prices: 20 cents for monthly Summary; 15 cents for annual Summary. Back issues sell at single copy rates. Checks and money orders should be made payable to, and remittances and correspondence should be sent to the Superintendent of Documents, Government Printing Office, Washington, D. C., 20402.

USCOMH-NOAA-ASHEVILLE, N. C. -3-31-72--3000

SUBROUTINE SIGNCK(IFLD,ISGN)

C THIS SUBROUTINE WILL TEST ANY PSYCHROMETRIC WITH A SIGN  
 C OVER UNITS POSITION READ AS A1 AND THE HIGH ORDER POSITION  
 C AS AN I SPEC OF PROPER WIDTH.  
 C THE SIGN SHOULD ENTER THE PARAMETER LIST AS ISGN,  
 C THE REMAINING PORTION AS IFLD.  
 C UPON RETURN FROM THIS ROUTINE, THE VALUE OF THE FIELD  
 C WILL BE AN INTEGER WITH PROPER SIGN.  
 C IT WILL BE THE USER RESPONSIBILITY TO CONVERT THIS TO REAL  
 C FORM WITH PROPER DECIMAL ALIGNMENT.  
 C INVALID CONDITION CAUSED IFLD TO BE SET TO 9999

DIMENSION IP(10),MIN(10),NUM(10)

DATA IP/'A','B','C','D','E','F','G','H','I','<sup>+</sup>0'/  
 DATA MIN/'J','K','L','M','N','O','P','Q','R','<sup>-</sup>0'/  
 DATA NUM/1,2,3,4,5,6,7,8,9, 0 /, IAST/'\*'/

IF (ISGN.EQ.IAST) GO TO 16

DO 14 K=1,10

IF (ISGN.EQ. IP(K)) GO TO 20

IF (ISGN.EQ. MIN(K)) GO TO 22

14 CONTINUE

16 IFLD=9999

RETURN

20 IFLD=IFLD\*10+NUM(K)

RETURN

22 IFLD= -(IFLD\*10+NUM(K))

RETURN

END

SUN

An Algorithm to Find Solar Position, and Intensity of Direct Normal and Diffuse Radiation

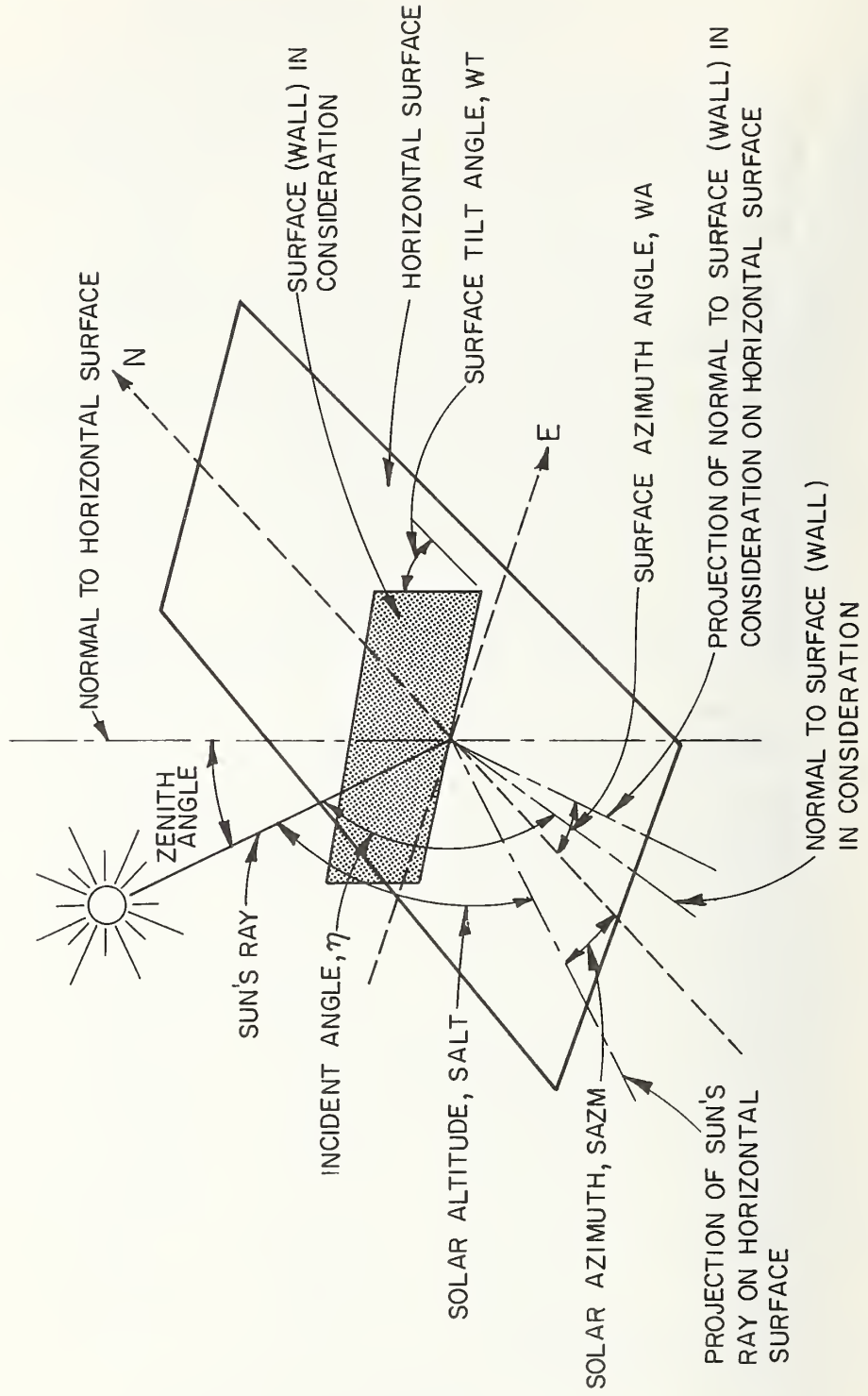

Figure A-1 Solar Angles for Tilted and Horizontal Surfaces

Figure A-1 DEFINITIONS OF SOLAR ANGLE

Data:

- L: Latitude, degrees,  $\begin{bmatrix} +\text{North} \\ -\text{South} \end{bmatrix}$
- $\ell$ : Longitude, degrees,  $\begin{bmatrix} +\text{West} \\ -\text{East} \end{bmatrix}$
- TZN: Time zone number (hours behind Greenwich mean time),  
(see Figure A-3 and Table A-4)
- d: Date, days (from start of year), (1 - 366)
- t: Time, hours (after midnight), (0 - 24)
- DST: Daylight saving time indicator (Output of DST),  
0 for standard time and 1 for daylight saving time
- $\rho_g$ : Ground reflectivity
- CN: Clearness number (see Figure A-4)



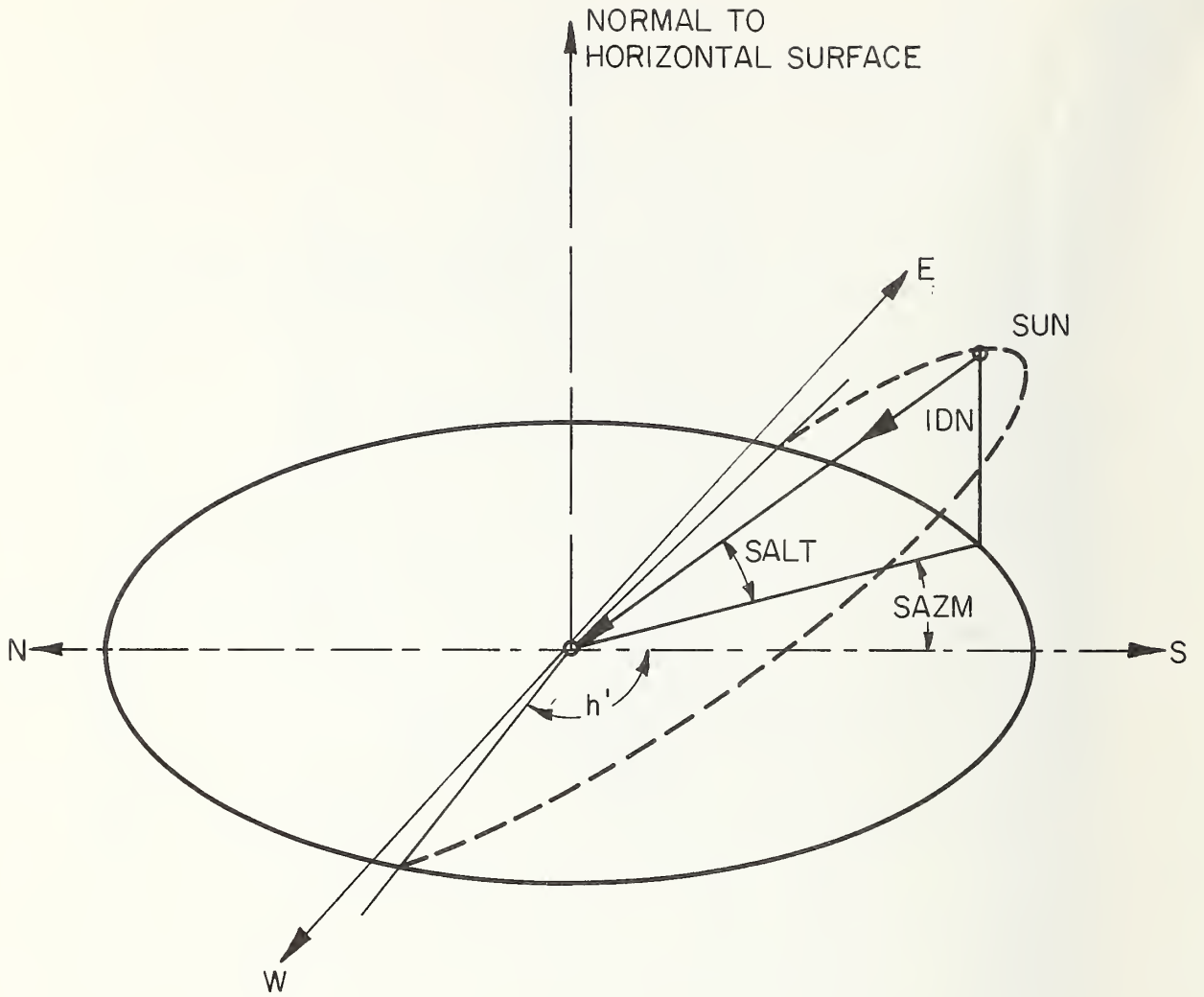

Figure A-2 Schematic Showing Apparent Path of Sun and Hour Angle

Figure A-3 Time Zones in the United States

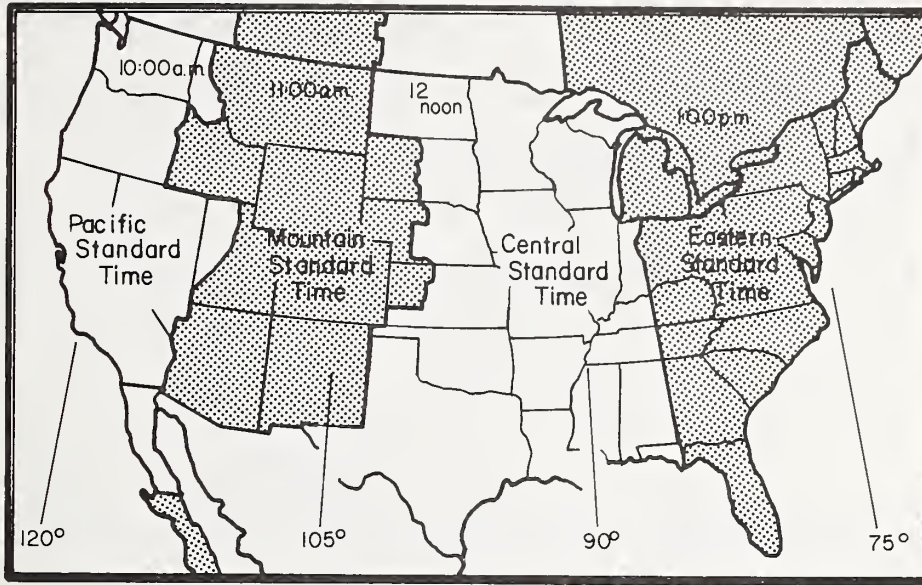

Table A-3 Time Zone Numbers in U. S. for Standard Time

TIME ZONE	TZN
Atlantic	4
Eastern	5
Central	6
Mountain	7
Pacific	8

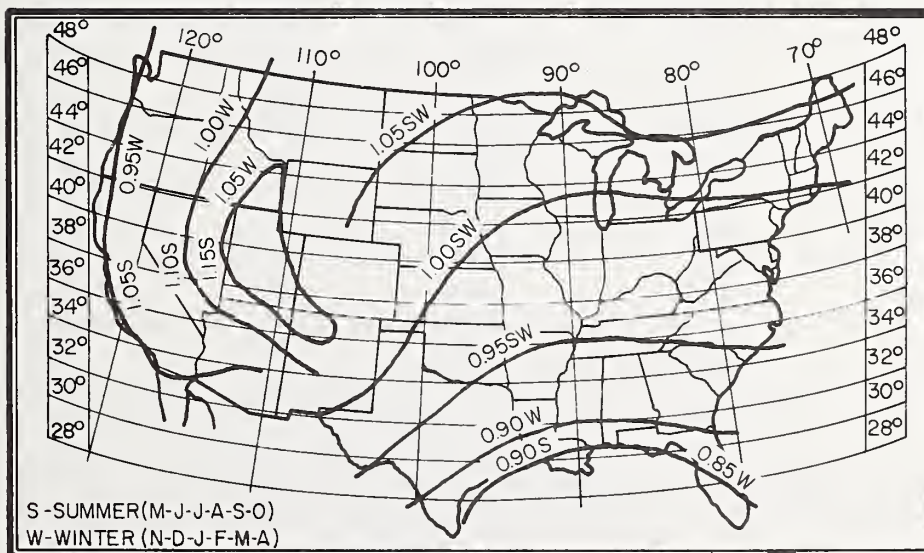

Figure A-4 Clearness Numbers of Non-Industrial Atmosphere in United States

Table A-4 lists, as function of date, five variables related to solar radiation. These variables are declination angle,  $\delta$ ; the equation of time, ET; the apparent solar constant, A; the atmospheric extinction coefficient, B; the sky diffuse factor, C.

TABLE A-4 VALUES OF  $\delta$ , ET, A, B AND C\*

Date	$\delta$ Degrees	ET Hours	A Btu Per (hr) (sq ft)	B Air Mass <sup>-1</sup>	C
Jan. 21	-20.0	-.190	390	0.142	0.058
Feb. 21	-10.8	-.230	385	0.144	0.060
Mar. 21	0.0	-.123	376	0.156	0.071
Apr. 21	11.6	.020	360	0.180	0.097
May 21	20.0	.060	350	0.196	0.121
June 21	23.45	-.025	345	0.205	0.134
July 21	20.6	-.103	344	0.207	0.136
Aug. 21	12.3	-.051	351	0.201	0.122
Sept. 21	0.0	.113	365	0.177	0.092
Oct. 21	-10.5	.255	378	0.160	0.073
Nov. 21	-19.8	.235	387	0.149	0.063
Dec. 21	-23.45	.033	391	0.142	0.057

\* Derived from the 1972 ASHRAE Handbook of Fundamentals, Table 1, p. 387, Chapter 22.

Calculation Sequence:

1. Determine  $\delta$ , ET, A, B, and C from Table A-4

2.  $h' = \cos^{-1} (-\tan(L) \cdot \tan(\delta))$  (see Figure A-2)

3.  $Y = h' \cdot 12 / \pi$

4. Sunrise time (SRT) and sunset time (SST) in hr

$$SRT = 12 - Y - ET - TZN + \ell / 15$$

$$SST = 24 - SRT$$

5. Hour angle h in degrees

$$h = 15 \cdot (t - 12 + TZN + ET) - \ell$$

If  $|h| > |h'|$  skip all the remaining calculations in this sequence and set

$$IDN = 0$$

$$BS = 0$$

$$BG = 0$$

6. Direction cosines of direct solar beam

$$\cos(Z) = \sin(L) \cdot \sin(\delta) + \cos(L) \cdot \cos(\delta) \cdot \cos(h)$$

$$\cos(W) = \cos(\delta) \cdot \sin(h)$$

$$\cos(S) = (1 - (\cos(Z))^2 - (\cos(W))^2)^{0.5}$$

If  $\cos(h) > \tan(\delta) / \tan(L)$ ,  $\cos(S)$  is positive

7. Solar altitude angle in radians

$$SALT = \sin^{-1} (\cos(Z))$$

8. Solar azimuth angle in radians

$$SAZM = \sin^{-1} (\cos(W) / \cos(SALT)), \text{ if } \cos(S) > 0$$

$$SAZM = \pi - \sin^{-1} (\cos(W) / \cos(SALT)), \text{ if } \cos(S) < 0$$

9. Intensity of direct solar radiation for a cloudless condition

$$IDN = A \cdot CN \cdot \exp(-B / \cos(Z))$$

10. Diffuse sky radiation (sky brightness) for a cloudless condition

$$BS = C * IDN / (CN) ** 2$$

11. Ground reflected radiation for a cloudless condition (ground brightness)

$$BG = \rho_g * (BS + IDN * \cos(Z))$$

Calculation Modification for Southern Hemisphere:

The preceding algorithm is applicable to the northern hemisphere only. For buildings in the southern hemisphere, the following modifications are required.

1. Shift values of B and C in Table A-4 by six months.

Values of  $\delta$ , ET, A, B and C for the southern hemisphere are shown in Table A-5.



TABLE A-5 VALUES OF  $\delta$ , ET, A, B and C FOR SOUTHERN HEMISPHERE

Date	$\delta$ Degrees	ET Hours	A Btu per (hr) (sq ft)	B Air Mass <sup>-1</sup>	C
Jan. 21	-20.0	-.190	390	0.207	0.136
Feb. 21	-10.8	-.230	385	0.201	0.122
Mar. 21	0.0	-.123	376	0.177	0.092
Apr. 21	11.6	.020	360	0.160	0.073
May 21	20.0	.060	350	0.149	0.063
June 21	23.45	-.025	345	0.142	0.057
July 21	20.6	-.103	344	0.142	0.058
Aug. 21	12.3	-.051	351	0.144	0.060
Sept. 21	0.0	.113	365	0.156	0.071
Oct. 21	-10.5	.255	378	0.180	0.097
Nov. 21	-19.8	.235	387	0.196	0.121
Dec. 21	-23.45	.033	391	0.205	0.134

If  $L \geq 0$  and if  $\cos(h) > (\tan(\delta)/\tan(L))$ ,  $\cos(s)$  is positive,  
and if  $\cos(h) \leq (\tan(\delta)/\tan(L))$ ,  $\cos(s)$  is negative.

If  $L < 0$  and if  $\cos(h) \leq (\tan(\delta)/\tan(L))$ ,  $\cos(s)$  is positive,  
if  $\cos(h) > (\tan(\delta)/\tan(L))$ ,  $\cos(s)$  is negative.

## CCF

### An Algorithm for the Calculation of Cloudy Day Solar Radiation

This routine estimates the factor called CCF to modify the total solar radiation on a horizontal surface with the observed cloud cover data for a cloudy sky condition. The cloud cover observations are made every hour at major weather stations by experienced observers who estimate the amount of cloud on a scale of 0 to 10 and indicate the type of cloud in four different layers. Kimura and Stephenson<sup>1/</sup> analyzed 1967 Canadian data for observed solar radiation with respect to the cloud cover data, type of cloud, and the calculated solar radiation under a cloudless condition at the same solar time. Based upon their analysis, a comprehensive methodology was developed for calculating the cloudy day solar radiation. The value of CCF, Cloud Cover Factor, is first defined as follows:

$$CCF = ITHC/ITH$$

where

ITHC: Total solar radiation on a horizontal surface under a cloudy sky of given cloud amount and types of cloud

ITH: Total solar radiation calculated for a horizontal surface under a cloudless sky at the same solar hour as of ITHC

Data:

- IS: Season index
- $CA_j$ : Cloud amount at the j-th layer, where j = 1, 2, 3, and 4
- $TOC_j$ : Type of cloud at the j-th layer, where j = 1, 2, 3, and 4
- TCA: Total cloud amount

Calculation Sequence:

1.  $X = (\sum CA_j)_{\text{cirrus}} + (\sum CA_j)_{\text{cirrostratus}} + (\sum CA_j)_{\text{cirrocumulus}}$

2. Cloud cover

$$CC = TCA - 0.5 * X$$

3. Cloud cover factor

$$CCF = P + Q * CC + R * CC ** 2$$

where P, Q, and R are found in the following table

Table A-6

Season	P	Q	R
spring	1.06	0.012	-0.0084
summer	0.96	0.033	-0.0106
autumn	0.95	0.030	-0.0108
winter	1.14	0.003	-0.0082

The value of P, which is essentially the cloudless sky factor, depends upon the proportion of direct to diffuse sky radiation in reference to the standard ASHRAE values published in the 1972 Handbook of Fundamentals. If the value of P is unity, this proportion of direct to diffuse solar radiation is such that the solar radiation evaluated for a hori-

zontal surface under a cloudless sky should be equal to the value obtained by the method described in the 1972 ASHRAE Handbook of Fundamentals. If the value of P is different from unity, the direct to diffuse proportion is different from the standard values.



## SOLAD

### An Algorithm for Determining Diffuse and Direct Radiation Falling Onto a Surface

This routine determines the total as well as the diffuse and direct components of solar radiation incident on a given surface under either clear or cloudy sky by using the cloudless sky data calculated in the SUN routine and the cloud cover factor CCF calculated as described in the previous section.

#### Data:

- P: Cloudless sky factor shown in Table (A-6) in the CCF routine
- C: Standard diffuse sky factor shown in Table A-4 in the SUN routine
- CC: Cloud cover calculated in the CCF routine
- CCF: Cloud cover factor determined by the CCF routine
- WA: Azimuth angle of the surface under consideration in radians from south; + if west and - if east of south
- WT: Tilt angle of the surface under consideration in radians from the horizontal surface; zero for the horizontal surface and  $\pi/2$  for the vertical walls

COS(Z), COS(W), AND COS(S):

Direction cosines of direct radiation (Calculated in SUN)

IDN: Intensity of the direct normal solar radiation for a cloudless condition in Btu per (hr) (sq ft) (Calculated in SUN)

BS and BG: Diffuse radiation from the cloudless sky and that from ground in Btu per (hr) (sq ft) (Calculated in SUN)

SALT: Solar altitude angle in radians (Calculated in SUN)

Calculation Sequence:

1. Let  $X = \text{SIN}(\text{SALT})$
2.  $Y = 0.309 - 0.137 * X + 0.394 * X * X^2$
3.  $K = X / (C + X) + (P - 1) / (1 - Y)$
4. Direct radiation on a horizontal surface under a cloudless sky  
 $\text{IDH} = \text{IDN} * \text{COS}(Z)$
5. Diffuse radiation on a horizontal surface under a cloudless sky  
 $\text{IdH} = \text{BS}$
6. Total radiation on a horizontal surface under a cloudless sky  
 $\text{ITH} = \text{IDH} + \text{IdH}$
7. Direct radiation on a horizontal surface under a cloudy sky  
 $\text{IDHC} = \text{ITH} * K * (1 - \text{CC}/10)$

8. Direction cosines of normal to the surface under consideration (the surface has an azimuth angle of WA and a tilt angle of WT)

$$\alpha = \text{COS}(WT)$$

$$\beta = \text{SIN}(WA)*\text{SIN}(WT)$$

$$\gamma = \text{COS}(WA)*\text{SIN}(WT)$$

9. Cosine of the incident radiation on the surface under consideration

$$\text{COS}(\eta) = \alpha \text{COS}(Z) + \beta \text{COS}(W) + \gamma \text{COS}(S)$$

10. Direct radiation on a surface under consideration under a cloudless sky

$$\text{ID} = \text{IDN}*\text{COS}(\eta)$$

$$= 0 \text{ if } \text{COS}(\eta) \leq 0$$

11. Direct radiation on a surface under a cloudy sky

$$\text{IDC} = \text{ID}*\text{IDHC}/\text{IDH}$$

12. Diffuse radiation for a cloudless sky

$$\text{Id} = \text{BS} \text{ for the horizontal surface}$$

$$\text{Id} = \text{BS}*Y + \text{BG}/2 \text{ for the vertical surfaces*}$$

$$\text{where } Y = 0.55 + 0.437*U + 0.313*U**2$$

$$U = \text{COS}(\eta)$$

$$\text{if } U \leq -0.2, Y = 0.45$$

13. Diffuse radiation upon a horizontal surface under a cloudy sky

$$\text{IdHC} = \text{ITH}*(\text{CCF}-K*(1 - \text{CC}/10))$$

---

\* Diffuse radiation data for surfaces other than vertical and horizontal ones have not been analyzed sufficiently to date to provide a calculation procedure.

14. Diffuse radiation on a surface under consideration

$$I_dC = I_d * I_{dHC} / I_{dH}$$

15. Total radiation upon a surface under a cloudy sky

$$I_{TC} = I_{DC} + I_dC$$

When the cloud cover CC is zero,

$$I_{TC} = I_T = I_D + I_d$$

## TAR

### An Algorithm for Calculating Transmission, Absorption and Reflection Factors for Windows

#### Data:

$\text{Cos}(\eta)$ : Cosine of angle of incidence of direct solar radiation (Calculated in SUN)

$k*\ell$ : Extinction coefficient [ $\text{inches}^{-1}$ ] \* thickness  
[inches]

NOTE: In some cases, glass manufacturers provide the value of transmission at normal incidence. In this case, using the curve given in Figure A-5, it is possible to obtain the value of  $k*\ell$ . The data for the curve are taken from reference 2.

#### Calculation Sequence:

##### A. Single-Pane Glass

1. Cosine of refraction angle

$$\text{COS}(\xi) = \text{SQRT} (1 - (1 - \text{COS}(\eta) ** 2) / n)$$

where  $n = 1.520$ , which is the index of refraction for ordinary glass

2. The fraction of radiation that is absorbed in a single pass through a sheet of glass of extinction coefficient  $k*\ell$

$$a = 1 - \text{Exp} (-k*\ell / \text{COS}(\xi))$$



3. Single glass air-glass interface reflectivity by the Fresnel's formula

vibration in parallel to the plane of glass

$$r = (\text{TAN } (\eta - \xi)) ** 2 / \text{TAN } (\eta + \xi)$$

vibration in normal to the plane of glass

$$r' = (\text{SIN } (\eta - \xi)) ** 2 / (\text{SIN } (\eta + \xi)) ** 2$$

4. Absorptivity for direct radiation

$$A_{\eta} = 0.5 * (x + x')$$

$$\text{where } x = a * (1 - r) * (1 + r * (1 - a)) / (1 - r * r * (1 - a) * (1 - a))$$

$$x' = a * (1 - r') * (1 + r' * (1 - a)) / (1 - r' * r' * (1 - a) * (1 - a))$$

5. Transmissivity for direct radiation

$$T_{\eta} = 0.5 * (y + y')$$

$$\text{where } y = (1 - r) * (1 - r) * (1 - a) / (1 - r * r * (1 - a) * (1 - a))$$

$$y' = (1 - r') * (1 - r') * (1 - a) / (1 - r' * r' * (1 - a) * (1 - a))$$

6. Absorptivity and transmissivity for diffuse radiation

$$A_d = \int_0^{\pi/2} A_{\eta} \text{SIN } (2\eta) d\eta$$

$$T_d = \int_0^{\pi/2} T_{\eta} \text{SIN } (2\eta) d\eta$$

## B. Double-Pane Glass

For the double-pane window, transmissivity and absorptivity for the outer and inner panes can be calculated separately first by using the single-pane procedure described above. Those calculated single glass properties can be designated here as follows:

$A_1$ : Absorptivity of inner pane for direct radiation

$A_2$ : Absorptivity of outer pane for direct radiation

$T_1$ : Transmissivity of inner pane for direct radiation

$T_2$ : Transmissivity of outer pane for direct radiation

$A_{1d}$ : Absorptivity of inner pane for diffuse radiation

$A_{2d}$ : Absorptivity of outer pane for diffuse radiation

$T_{1d}$ : Transmissivity of inner pane for diffuse radiation

$T_{2d}$ : Transmissivity of outer pane for diffuse radiation

### 1. Reflectivity of inner and outer panes

$$R_{1\eta} = 1 - A_{1\eta} - T_{1\eta}$$

$$R_{2\eta} = 1 - A_{2\eta} - T_{2\eta}$$

$$R_{1d} = 1 - A_{1d} - T_{1d}$$

$$R_{2d} = 1 - A_{2d} - T_{2d}$$

### 2. Absorptivity of the double-glazed system

#### a. Direct radiation

$$A_{\eta, \text{outer}} = A_{2\eta} * (1 + R_{1\eta} * T_{2\eta} / (1 - R_{1\eta} * R_{2\eta}))$$

$$A_{\eta, \text{inner}} = A_{1\eta} * T_{2\eta} / (1 - R_{1\eta} * R_{2\eta})$$

b. Diffuse radiation

$$A_{d,outer} = A_{2d} * (1 + R_{1d} * T_{2d} / (1 - R_{1d} * R_{2d}))$$

$$A_{d,inner} = A_{1d} * T_{2d} / (1 - R_{1d} * R_{2d})$$

3. Transmissivity of the double

a. Direct radiation

$$T_{\eta} = T_{1\eta} * T_{2\eta} / (1 - R_{1\eta} * R_{2\eta})$$

b. Diffuse radiation

$$T_d = T_{1d} * T_{2d} / (1 - R_{1d} * R_{2d})$$

Since the calculation of transmissivity and absorptivity are quite involved, they have been precalculated by Stephenson<sup>3/</sup> for various values of COS ( $\eta$ ) and expressed as polynomial functions of COS ( $\eta$ ). The polynomial coefficients are shown in Table A-3 for single and double glazed windows and the equations are as follows:

Single-pane, direct radiation transmission

$$T_{\eta} = \sum_{j=0}^5 t_j * (\text{Cos}(\eta) ** j)$$

Single-pane, diffuse radiation transmission

$$T_d = 2 * \sum_{j=0}^5 t_j / (j + 2)$$

Polynomial representations of absorption factors for direct solar and diffuse radiation.

Double-pane, direct radiation transmission

$$A_{\eta, \text{outer}} = \sum_{j=0}^5 a_{j, \text{outer}} * ((\text{Cos } \eta) ** j)$$

$$A_{\eta, \text{inner}} = \sum_{j=0}^5 a_{j, \text{inner}} * ((\text{Cos } \eta) ** j)$$

Double-pane, diffuse radiation transmission

$$A_{d, \text{outer}} = 2 * \sum_{j=0}^5 a_{j, \text{outer}} / (j + 2)$$

$$A_{d, \text{inner}} = 2 * \sum_{j=0}^5 a_{j, \text{inner}} / (j + 2)$$

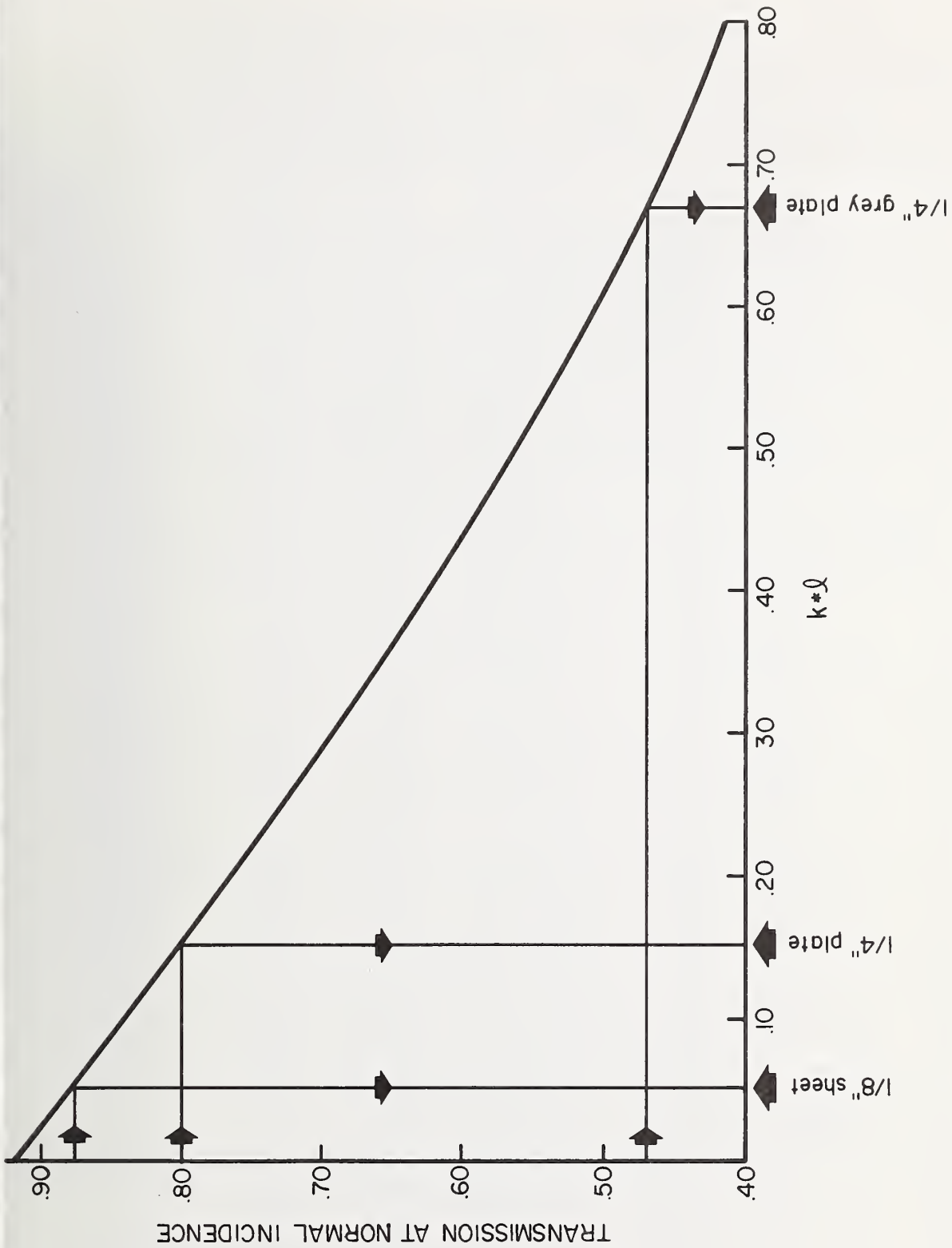

Figure A-5 Transmission at Normal Incidence Versus  $k \cdot Q$  for Single Sheet Glass



Table A-7 Polynomial Coefficients for Use in Calculation of Transmittance and Absorptance of Glass

$k \times \nu$	j	Single Glazing		Double Glazing		
		$a_j$	$t_j$	$a_{j,outer}$	$a_{j,inner}$	$t_j$
0.05 1/8" Sheet	0	0.01154	-0.00885	0.01407	0.00228	-0.00401
	1	0.77674	2.71235	1.06226	0.34559	0.74050
	2	-3.94657	-0.62062	-5.59131	-1.19908	7.20350
	3	8.57881	-7.07329	12.15034	2.22366	-20.11763
	4	-8.38135	9.75995	-11.78092	-2.05287	19.68824
	5	3.01188	-3.89922	4.20070	0.72376	-6.74585
0.10	0	0.01636	-0.01114	0.01819	0.00123	-0.00438
	1	1.40783	2.39371	1.86277	0.29788	0.57818
	2	-6.79030	0.42978	-9.24831	-0.92256	7.42065
	3	14.37378	-8.98262	19.49443	1.58171	-20.26648
	4	-13.83357	11.51798	-18.56094	-1.40040	19.79706
	5	4.92439	-4.52064	6.53940	0.48316	-6.79619
0.15 1/4" Reg. Plate	0	0.01837	-0.01200	0.01905	0.00067	-0.00428
	1	1.92497	2.13036	2.47900	0.26017	0.45797
	2	-8.89134	1.13833	-11.74226	-0.72713	7.41367
	3	18.40197	-10.07925	24.14037	1.14950	-19.92004
	4	-17.48648	12.44161	-22.64299	-0.97138	19.40969
	5	6.17544	-4.83285	7.89954	0.32705	-6.66603
0.20	0	0.01902	-0.01218	0.01862	0.00035	-0.00401
	1	2.35417	1.90950	2.96400	0.22974	0.36698
	2	-10.47151	1.61391	-13.48701	-0.58381	7.27324
	3	21.24322	-10.64872	27.13020	0.84626	-19.29364
	4	-19.95978	12.83698	-25.11877	-0.67666	18.75408
	5	6.99964	-4.95199	8.68895	0.22102	-6.43968
0.40	0	0.01712	-0.01056	0.01423	-0.00009	-0.00279
	1	3.50839	1.29711	4.14384	0.15049	0.16468
	2	-13.86390	2.28615	-16.66709	-0.27590	6.17715
	3	26.34330	-10.37132	31.30484	0.25618	-15.84811
	4	-23.84846	11.95884	-27.81955	-0.12919	15.28302
	5	8.17372	-4.54880	9.36959	0.02859	-5.23666
0.60	0	0.01406	-0.00835	0.01056	-0.00016	-0.00192
	1	4.15958	0.92766	4.71447	0.10579	0.08180
	2	-15.06279	2.15721	-17.33454	-0.15035	4.94753
	3	27.18492	-8.71429	30.91781	0.06487	-12.43481
	4	-23.88518	9.87152	-26.63898	0.02759	11.92495
	5	8.03650	-3.73328	8.79495	-0.02317	-4.07787
0.80 50% Trans. H.A. Plate	0	0.01153	-0.00646	0.00819	-0.00015	-0.00136
	1	4.55946	0.68256	5.01768	0.07717	0.04419
	2	-15.43294	1.82449	-17.21228	-0.09059	3.87529
	3	26.70568	-6.95325	29.46388	0.00050	-9.59069
	4	-22.87993	7.80647	-24.76915	0.06711	9.16022
	5	7.57795	-2.94454	8.05040	-0.03394	-3.12776
1.00	0	0.00962	-0.00496	0.00670	-0.00012	-0.00098
	1	4.81911	0.51403	5.18781	0.05746	0.02576
	2	-15.47137	1.47607	-16.84820	-0.05878	3.00400
	3	25.86516	-5.41985	27.90292	-0.01855	-7.33834
	4	-21.69106	6.05546	-22.99619	0.06837	6.98747
	5	7.08714	-2.28162	7.38140	-0.03191	-2.38328

SHG

An Algorithm for Calculating Solar Heat Gain Through Windows

Data:

- IDN: Intensity of direct normal solar radiation,  
Btu per (hr) (sq ft), (Calculated in SUN)
- BS: Sky brightness, Btu per (hr) (sq ft), (Cal-  
culated in SUN)
- BG: Ground brightness, Btu per (hr) (sq ft),  
(Calculated in SUN)
- $\text{Cos}(\eta)$ : Cosine of the angle of incidence of direct  
solar radiation, (Calculated in SUN)
- FWS: Form factor between the window and the  
sky\*
- FWG: Form factor between the window and the  
ground\*
- RO, RA, RI: Thermal resistances at outside surface,  
air space, and inside surface respectively,  
(sq ft) (hr) (F) per Btu
- SLA: Sunlit area factor (Calculated in SHADOW)
- SC: Shading coefficient if the window is shaded  
by drapes or blinds or if it has an inter-  
pane separation of more than 1 inch

---

\* If more accurate data are not available, use  $\text{FWS} = \text{FWG} = 0.5$ .

NOTE: When the value of SC is given, these transmission and absorption factors should be for the standard 1/8" thick double strength glass (or  $k \cdot \ell = 0.05$  of TAR) regardless of the type of glass used.

$T_{\eta}$ ,  $T_d$ : Transmission factors for direct and diffuse solar radiation for windows (Calculated in TAR)

$A_{\eta,outer}$ ,  $A_{\eta,inner}$ ,  $A_{d,outer}$ ,  $A_{d,inner}$ :  
Absorption factors for direct and diffuse solar radiation through outer and inner window panes (Calculated in TAR), respectively

Calculation Sequence:

1. Inward flowing fraction of the radiation absorbed by the inner and the outer pane, respectively

$$NI = (RO + RA) / (RO + RA + RI)$$

$$NO = RO / (RO + RA + RI)$$

2. Let

$$D = SLA \cdot IDN \cdot \cos(\eta) \cdot (T_{\eta} + NO \cdot A_{\eta,outer} + NI \cdot A_{\eta,inner})$$

$$d = (BS \cdot FWS + BG \cdot FWG) \cdot (T_d + NO \cdot A_{d,outer} + NI \cdot A_{d,inner})$$

3. Solar heat gain through window

If  $SC = 0$ ,  $SHG = D + d$

If  $SC \neq 0$ ,  $SHG = (SC) \cdot (D + d)_{k \cdot \ell = 0.05}$

## SHADOW

### A Brief Description of the Procedures for Calculating External Shadows on a Building

A major portion of the air conditioning load on modern commercial buildings comes from solar radiation. To improve the accuracy of load assessment, it is necessary to know how much of a building is shaded and how much lies exposed to the sun's rays.

A new technique developed by Groth and Lokmanhekim<sup>4/</sup> employs the representation of all architectural forms as a series of plane polygons. Even curved surfaces can be so represented. For example, a sphere may be approximated by the 20 sides of a regular icosohedron. This approximation gives a maximum error of only 3% in the shadow area cast by the sphere.

The output of the algorithm is not only the sunlit area, but also a pictorial display of the shadows and the surface upon which they are cast.

#### Coordinate Transformation:

Designate the polygons which cast shadows as shading polygons (SP) and those upon which shadows are cast as receiving polygons (RP). The vertex coordinates of each RP, and its relevant SP's, are transformed from a base coordinate system,  $xyz$ , to a new coordinate system,  $x'y'z'$ , with origin 0 attached to the plane of the RP. The first three vertices,

$V_1$ ,  $V_2$ , and  $V_3$ , of the RP being examined are used to define this new coordinate system. The  $x'$  axis passes through  $V_2$  and  $V_3$ , while the  $y'$  axis passes through  $V_1$ . In order that the  $z'$  axis point outward from the surface, angle  $V_1V_2V_3$  must be convex and the vertices must be numbered counterclockwise. The equation of transformation is written in matrix form as

$$\vec{x}' = A (\vec{x} - \vec{x}_0)$$

where

$$\vec{x}_0 = \vec{x}_2 + \gamma(\vec{x}_3 - \vec{x}_2)$$

$$\gamma, \text{ A Scaler} = (\vec{x}_1 - \vec{x}_2) \cdot (\vec{x}_3 - \vec{x}_2) / (\vec{x}_3 - \vec{x}_2) \cdot (\vec{x}_3 - \vec{x}_2)$$

$$\text{1st row of } A = (\vec{x}_3 - \vec{x}_0) / |\vec{x}_3 - \vec{x}_0|$$

$$\text{2nd row of } A = (\vec{x}_1 - \vec{x}_0) / |\vec{x}_1 - \vec{x}_0|$$

$$\text{3rd row of } A = \text{1st row of } A \times \text{2nd row of } A$$

Solar altitude,  $\alpha$ , and azimuth,  $\beta$ , must also be transformed, into the solar direction vector, as

$$\vec{x}_s = \begin{pmatrix} \sin\beta \cdot \cos\alpha \\ \sin\alpha \\ \cos\beta \cdot \cos\alpha \end{pmatrix}$$

Clipping Transformation:

Any part of an SP whose  $z'$  is negative cannot cast a shadow on the RP. These "submerged" portions of the SP's must be clipped off, prior to projection, lest they project "false" shadows (see Figure A-6). This



is done by finding, through linear interpolation, the points A and B, on the perimeter of the SP, which pierce the plane of the RP, and taking these points as new vertices. All submerged vertices are deleted. This results in a new polygon with line AB as a side, which will project only real shadows.

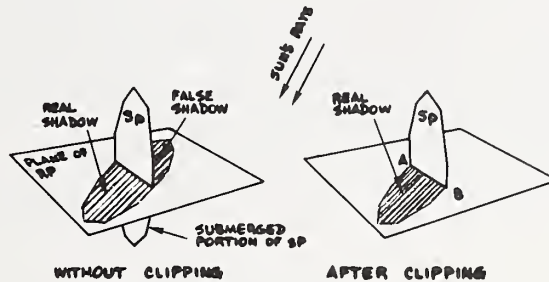

Figure A-6 Clipping

Projection Transformation:

To simulate the actual casting of a shadow, the following transformation projects, along the sun's rays, all the vertex points of the transformed and clipped RP's.

$$X = x' - \frac{x' z'}{z' s} z'$$

$$Y = y' - \frac{y' z'}{z' s} z'$$



Enclosure Test:

The coordinate, clipping and projection transformation have converted all RP and SP's in space into two dimensional figures in the RP plane. It remains only to find the points in the RP plane which lie inside the RP and inside one or more of the SP projections, i.e., points of the RP which are shaded. At this point, the two-space XY is divided into a grid and the center of each element of this grid is tested for enclosure by the RP and the SP projections. A point, P, whose coordinates are  $X_P Y_P$ , is inside of polygon  $V_1, V_2, \dots V_n$  if the following inequality holds.

$$\sum_{i=1}^n \Delta\theta_i \neq 0$$

The angular change,  $\Delta\theta_i$ , subtended at P by the ith side, and counted positive counterclockwise, is given by the following formulae.

$$\Delta\theta_i = \begin{cases} \theta_j - \theta_i & \text{if } |\theta_j - \theta_i| < 2 \\ \frac{(\theta_i - \theta_j)(4 - |\theta_i - \theta_j|)}{|\theta_j - \theta_i|} & \text{if } |\theta_j - \theta_i| \geq 2 \end{cases}$$

$$j = \begin{cases} i + 1 & \text{if } i < n \\ 1 & \text{if } i = n \end{cases}$$

$$\theta_i \sim \begin{array}{ll} \frac{Y_i - Y_P}{X_i - X_P + Y_i - Y_P} & \text{in 1st quadrant} \\ 1 + \frac{X_P - X_i}{X_P - X_i + Y_i - Y_P} & \text{in 2nd quadrant} \\ 2 + \frac{Y_P - Y_i}{X_P - X_i + Y_P - Y_i} & \text{in 3rd quadrant} \\ 3 + \frac{X_i - X_P}{X_i - X_P + Y_P - Y_i} & \text{in 4th quadrant} \end{array}$$

These approximate formulae, which express  $\Delta\theta_i$  in right angles, replace the time-consuming square root and arc cosine computer library routines. They have, by set theory, been proved adequate for the purpose.

#### Display Matrix and Sample Problem:

An alphanumeric matrix is created corresponding to the grid elements in the RP plane. A blank component represents a grid element either outside the RP or exposed to the sun. An asterisk component represents a shaded grid element or one on the RP's boundary. Grid elements shaded by a transmissive structure are randomly asterisked with a probability equal to the fraction of incident light stopped by the shading structure. Figure A-7 shows the solution of a typical problem involving a transmissive structure.

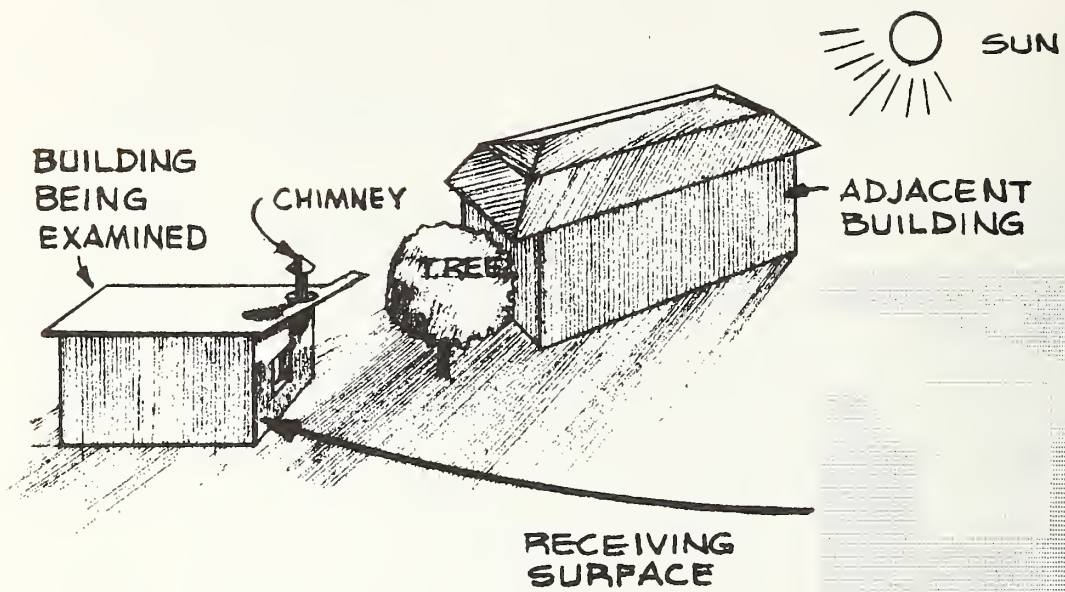

Figure A-7 The Computer Output of a Typical Problem

SHADOW 1\*

An Algorithm to Find the Ratio of the Sunlit and Shaded Area  
of a Given Window Where the Shadows are Cast by Various  
Combinations of Overhang and Side Fins

Data: (Variable names corresponding to the FORTRAN listing  
included in this section. Right and left is determined  
facing the window from outside - see Figure A-8).

HT: Window height

FL: Window width

FP: Depth of the overhang

AW: Distance from top of the window to the overhang

BWL: Distance of the overhang extended beyond the left edge  
of the window

BWR: Distance of the overhang extended beyond the right edge  
of the window

D: Depth of vertical projection at the end of the overhang

FP1: Depth of the left fin

A1: Distance of the left fin extended above the top of the  
window

B1: Distance from the left edge of the window to the left  
fin

C1: Distance of the left fin stop short above the bottom  
of the window

FP2: Depth of the right fin

---

\* This section was contributed by Tseng-Yao Sun; Ayres and Hayakawa,  
Los Angeles, California.

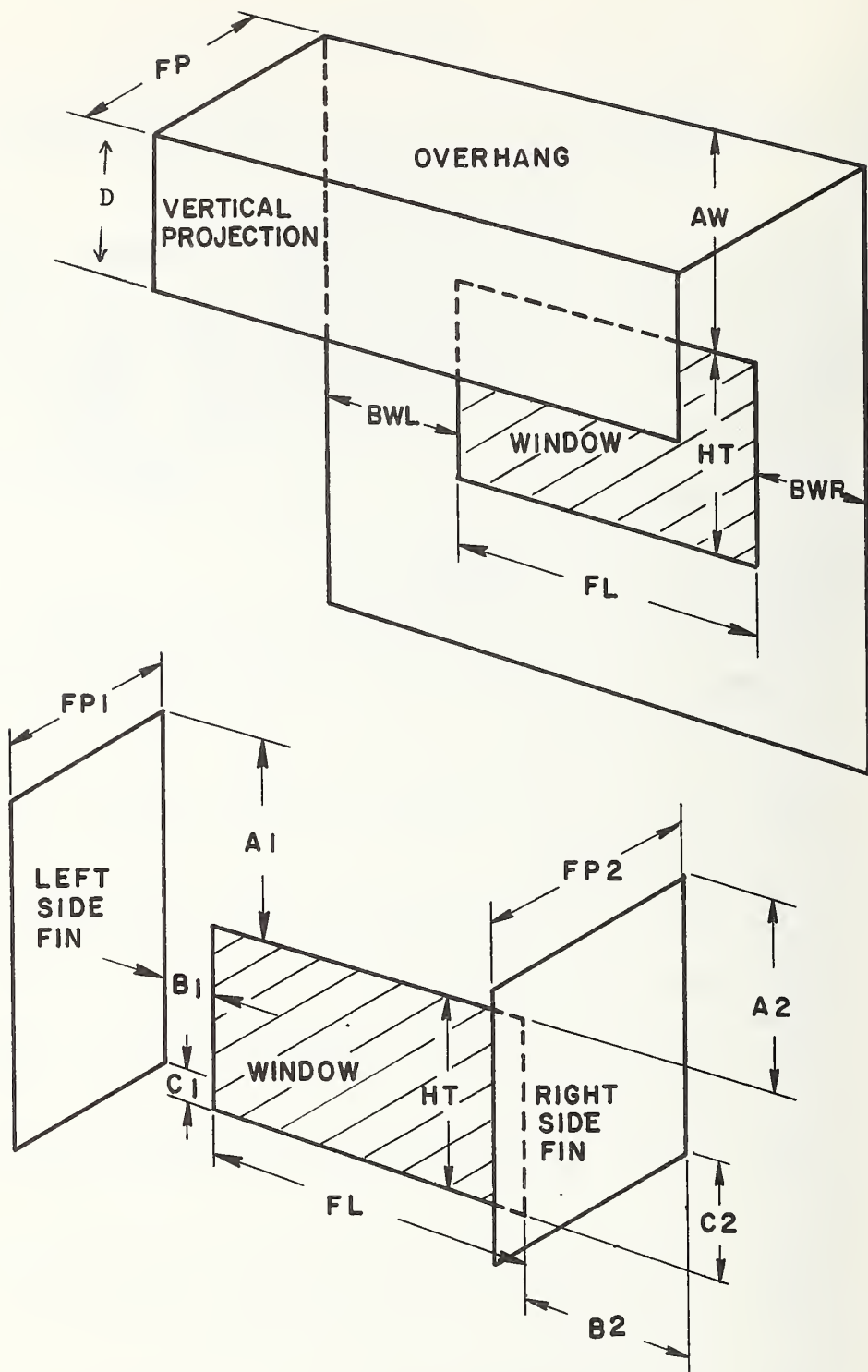

Figure A-8 Shadow 1 Input Data

A2: Distance of the right fin extended above the top of  
the window

B2: Distance from the right edge of the window to the  
right fin

C2: Distance of the right fin stop short above the bottom  
of the window

PHI: Solar azimuth angle

WAZI: Window azimuth angle

COSZ: Cosine of solar zenith angle

Calculation Sequence:

The principle calculation sequence of this subroutine is described in reference 5 and the principle output of the subroutine is the variable SHRAT--the shade ratio or ratio of sunlit area to the total window area. The treatment of shadow overlapping cast by various shading devices is not discussed in the reference but is included in the FORTRAN listing.



```

SUBROUTINE SHADOW(SHDX,PHI,COSZ,SHRAT)
DIMENSION SHDX(20)
FL=SHDX(1)
HT=SHDX(2)
FP=SHDX(3)
AW=SHDX(4)
BWL=SHDX(5)
BWR=SHDX(6)
D=SHDX(7)
FP1=SHDX(8)
A1=SHDX(9)
B1=SHDX(10)
C1=SHDX(11)
FP2=SHDX(12)
A2=SHDX(13)
B2=SHDX(14)
C2=SHDX(15)
WAZI=SHDX(16)
% THIS PROGRAM CALCULATES SHADOW CAST BY OVERHANG AND SIDE FINS
% PHI....SOLAR AZIMUTH ANGLE
% COSZ...COSINE OF SOLAR ZENITH ANGLE
% SHRAT...SHADE RATIO:RATIO OF THE SUNLIT AREA TO THE TOTAL WINDOW AREA
% HT.....WINDOW HEIGHT
% FL.....WINDOW WIDTH
% FP.....DEPTH OF THE OVERHUNG
% AW.....DISTANCE FROM TOP OF THE WINDOW TO THE OVERHUNG
% BWL....DISTANCE OF THE OVERHUNG EXTENDED BEYOND THE LEFT EDGE OF THE WINDOW
% BWR....DISTANCE OF THE OVERHUNG EXTENDED BEYOND THE RIGHT EDGE OF THE WINDOW
% D.....DEPTH OF VERTICAL PROJECTION AT THE END OF THE OVERHUNG
% FP1....DEPTH OF THE LEFT FIN
% A1.....DISTANCE OF THE LEFT FIN EXTENDED ABOVE THE TOP OF THE WINDOW
% B1.....DISTANCE FROM THE LEFT EDGE OF THE WINDOW TO THE LEFT FIN
% C1.....DISTANCE OF THE LEFT FIN STOP SHORT ABOVE THE BOTTOM OF THE WINDOW
% FP2....DEPTH OF THE RIGHT FIN
% A2.....DISTANCE OF THE RIGHT FIN EXTENDED ABOVE THE TOP OF THE WINDOW
% B2.....DISTANCE FROM THE RIGHT EDGE OF THE WINDOW TO THE RIGHT FIN
% C2.....DISTANCE OF THE RIGHT FIN STOP SHORT ABOVE THE BOTTOM OF THE WINDOW
% WAZI...WINDOW AZIMUTH ANGLE
SHRAT=1.
1103 A=AW
      H=HT
      GAMMA=PHI-WAZI
      COSG=COS(GAMMA)
      IF(COSG)100,100,104
100  SHRAT=0.
      GO TO 2000
104  CONTINUE
      SBETA=COSZ
      IF(SBETA)100,100,152
152  SING=SIN(GAMMA)
      VERT=SBETA/SQRT(1.-SBETA*SBETA)/COSG
      HORIZ=ARS(SING)/COSG
      TCETA=VERT/HORIZ

```

```

      IF (GAMMA) 155,154,154
% -----SUN ON LEFT
154  B=BWL
      GO TO 156
% -----SUN ON RIGHT
155  B=BWR
156  ARSHF=0.
      AREAV=0.
      ARSIF=0.
      AREA0=0.
      AREA1=0.
      ARSH1=0.
      FL3=0.
      H3=0.
      H1=H
      FL1=FL
      K=1
      L=1
      T1=FP*VERT
      FM1=FP*HORIZ
      IF (FP) 37, 37, 153
153  T=T1
      FM=FM1
      AB=B*TCETA
      UG=(FL+B)*TCETA
      DE=(H+A)/TCETA
% -----HORIZONTAL OVERHUNG "AREA0"
      IF (T-A) 27,27,2
2     IF (AB-A) 14,14,3
3     IF (DE-B) 12,12,4
4     IF (FM-B) 11,11,5
5     IF (DE-(FL+B)) 8,8,6
6     IF (FM-(FL+B)) 9,7,7
% -----HORIZ 9
7     AREA0=FL*(0.5*(AB+UG)-A)
      GO TO 37
8     IF (T-(H+A)) 9,10,10
% -----HORIZ 7
9     AREA0=(T-A)*FL-((FM-B)**2)*TCETA*0.5
      L=2
      GO TO 21
% -----HORIZ 8
10    AREA0=H*FL-(DE-B)**2*TCETA*0.5
      GO TO 37
% -----HORIZ 3
11    AREA0=FL*(T-A)
      L=2
      GO TO 24
12    IF (T-(H+A)) 11,13,13
% -----HORIZ 2
13    AREA0=H*FL
      GO TO 68
14    IF (UG-A) 27,27,15
15    IF (DE-(FL+B)) 18,18,16

```

```

16 IF (FM-(FL+B)) 20,17,17
% -----HORIZ 6
17 AREA0=(UG-A)**2/TCETA*0.5
GO TO 37
18 IF (T-(H+A)) 20,19,19
% -----HORIZ 5
19 AREA0=H*(FL-(A+0.5*H)/TCETA+B)
GO TO 37
% -----HORIZ 4
20 AREA0=(T-A)*(FL+B-FM*(1.+A/T)*0.5)
L=2
% -----VERT PROJ "AREAV"
21 FL3=FL+B-FM
IF (T+D-(H+A)) 22,22,23
% -----VERT 8
22 H3=D
GO TO 3700
% -----VERT 9
23 H3=H+A-T
GO TO 3700
24 FL3=FL
IF (T+D-(H+A)) 26,26,25
% -----VERT 7
25 H3=H+A-T
AREAV=H3*FL3
GO TO 68
% -----VERT 6
26 H3=D
GO TO 3700
27 IF (T+D-A) 37,37,28
28 IF (FM-B) 34,34,29
29 IF (FM-(FL+B)) 31,37,37
31 FL3=FL+B-FM
IF (T+D-(H+A)) 33,33,32
% -----VERT 5
32 H3=H
GO TO 3700
% -----VERT 4
33 H3=T+D-A
GO TO 3700
34 IF (T+D-(H+A)) 36,35,35
% -----VERT 2
35 AREAV=H*FL
GO TO 68
% VERT 3
36 H3=T+D-A
FL3=FL
3700 AREAV=FL3*H3
% -----SIDE FIN AND SHORT SIDE FIN
% -----SIDE FIN "AREA1" "ARSIF"
37 IF (GAMMA) 66,68,74
74 FPF=FP1
AF=A1
BF=B1

```

```

CX=C1
GO TO 84
66 FPF=FP2
AF=A2
BF=B2
CX=C2
84 IF (FPF) 68,68,67
67 T=FPF*VERT
FM=FPF*HORIZ
AF1=AF
IF (AREA0) 73,73,88
% -----TEST FOR OVERLAP OF FIN AND OVERHUNG SHADOW
88 AT=A+(BF-B)*TCETA
IF (AT-AF) 711,73,73
% -----OVERLAP EXISTS..L=2 IF OVERHUNG SHADOW HAS HORIZ EDGE IN WINDOW
711 GO TO (621,712),L
% -----TEST FOR TYPE OF OVERLAP
712 IF ((FM-BF)-(FM1-B)) 621,622,622
% -----SET L=1,SHADOW INTERSECT ON INCLINED EDGE OF OVERHUNG SHADOW
% -----FIN SHADOW IS BELOW INCLINED EDGE OF OVERHUNG SHADOW
621 AF=AT
L=1
GO TO 73
% -----L IS 2, HORIZ EDGE OF OVERHUNG SHADOW-PORION ABOVE HORIZ EDGE
% -----NOT IN OVERHUNG SHADOW IS FIN SHADOW
622 AREA1=FL*(T1-A)-AREA0
% -----RESET TO CALC FIN SHADOW BELOW HORIZ EDGE OF OVHNG SHADOW
AF=T1-A+AF1
H=H+AF1-AF
% -----SHADOW OF FIN (K=1 ON GLASS K=2 ON VERT PROJ SHADOW)
73 AB=BF*TCETA
UG=(FL+BF)*TCETA
DE=(H+AF)/TCETA
DJ=CX/TCETA
IF (FM-BF) 69,69,38
38 IF (AB-AF) 39,50,50
39 IF (UG-AF) 48,48,40
40 IF (T-AF) 47,47,41
41 IF (UG-(H+AF)) 44,44,42
42 IF (T-(H+AF)) 91,80,80
% -----FIN 9
80 AREA1=H*((AF+H*0.5)/TCETA-BF)+AREA1
GO TO 58
44 IF (FM-(FL+BF)) 91,89,89
% -----FIN 8
89 AREA1=H*FL-(UG-AF)**2/TCETA*0.5+AREA1
GO TO 58
% -----FIN 7
91 AREA1=(FM-BF)*H-(T-AF)**2/TCETA*0.5+AREA1
GO TO 63
48 IF (FM-(FL+BF)) 47,47,49
% -----FIN 3
47 AREA1=H*(FM-BF)+AREA1
GO TO 63

```

```

% -----FIN 2
49 AREA1=H*FL+AREA1
GO TO 58
50 IF (DE-BF) 69,69,51
51 IF (UG-(H+AF)) 55,55,52
52 IF (T-(H+AF)) 93,94,94
% -----FIN 6
94 AREA1=(DE-BF)**2*TCETA*0.5+AREA1
GO TO 58
% -----FIN 4
93 AREA1=(FM-BF)*(H+AF-(T+AB)*0.5)+AREA1
GO TO 63
55 IF (FM-(FL+BF)) 93,99,99
% -----FIN 5
99 AREA1=FL*(H-(BF+FL*0.5)*TCETA+AF)+AREA1
% -----SHORT SIDE FIN "ARSH1","ARSHF"
58 IF (DJ-BF) 69,69,59
59 IF (DJ-(FL+BF)) 61,61,60
% -----SHORT 3
60 ARSH1=-FL*(CX-(BF+FL/2.)*TCETA)
GO TO 69
% -----SHORT 4
61 ARSH1=-(CX-AB)**2/TCETA*0.5
GO TO 69
63 IF (DJ-BF) 69,69,64
64 IF (DJ-FM) 61,61,65
% -----SHORT 2
65 ARSH1=-(FM-BF)*(CX-(T+AB)*0.5)
69 GO TO (77,76),K
76 ARSH1=-ARSH1
AREA1=-AREA1
77 ARSHF=ARSHF+ARSH1
ARSIF=ARSIF+AREA1
GO TO (78,68),K
78 IF (AREAV) 68,68,72
% -----RESET PARAMETERS TO DEDUCT FIN SHADOW OVERLAP ON VERT PROJ SHADOW
72 K=2
AREA1=0.
ARSH1=0.
BBF=BF
BF=FM1-B+BF
IF (BF) 186,185,185
186 BF=BBF
185 IF (HT+A-T1-D) 87,87,188
188 CX=CX-(HT+A-T1-D)
IF (CX) 85,87,87
85 CX=0.
87 AF=T1-A+AF
H=H3
FL=FL3
GO TO 73
% ----- SHADED AREA "ARSHA"
68 ARSHA=AREA0+AREAV+ARSHF+ARSIF
SHRAT=(FL1*H1-ARSHA)/(FL1*H1)

```

2000 FL=FL1  
CONTINUE  
RETURN  
END



## SHADOW 2\*

### An Algorithm to Determine Whether or Not a Given Window is Shaded by a Remote Object Such as an Adjacent Building

This algorithm is approximate and is applicable only where the window is relatively small in comparison to the shading object. Large windows may be subdivided into smaller segments for this consideration. The window is considered either completely shaded or completely in sun. Partially shaded window can be considered in either case depending on the location of the window reference point. Figure A-9 shows a typical window-shading object relationship.

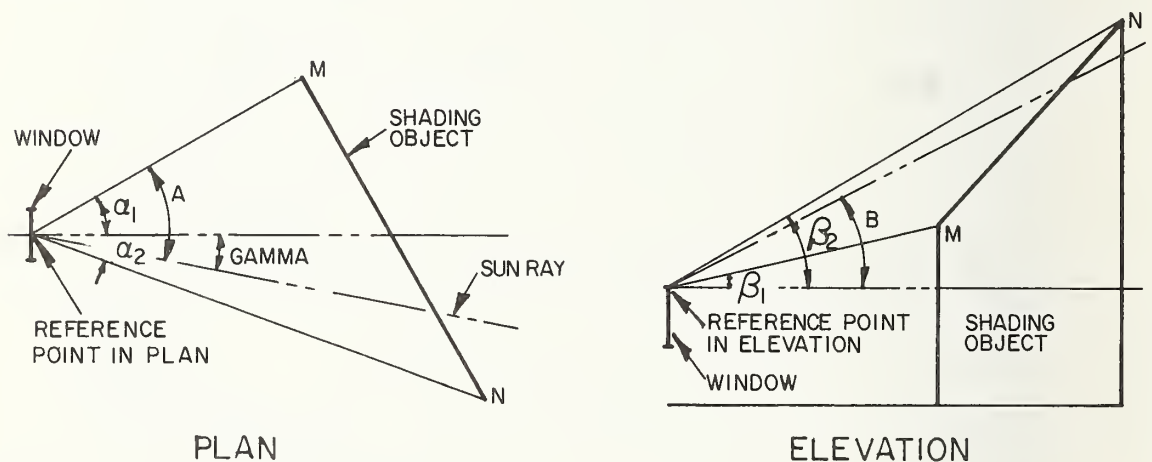

Figure A-9 A Typical Window-Shading Object Relationship

Note that the reference point can be located at any point on the window. Locating the reference point at the top of the window as shown in the elevation in Figure A-9 is slightly conservative as compared to if the reference point is located at the center of the window.

\* This section was contributed by Tseng-Yao Sun; Ayres, Cohen and Hayakawa, Los Angeles, California.

Data:

$\alpha_1, \alpha_2$ : Azimuth shadow limit angles. Right +, Left -

$\beta_1, \beta_2$ : Altitude shadow limit angles

WAZI: Window azimuth angle

PHI: Solar azimuth angle

BETA: Solar altitude angle

Calculation Sequence:

This subroutine determines whether the window is sunlit or shaded for the given position of the sun.

1. Wall-solar azimuth angle

$$\text{GAMMA} = \text{PHI} - \text{WAZI}$$

2. If  $\text{GAMMA} < \alpha_1$  or  $\text{GAMMA} > \alpha_2$ , the window is in sun

3. If  $\alpha_2 > \text{GAMMA} > \alpha_1$ ,

$$A = \text{GAMMA} - \alpha_1$$

$$B = \beta_1 + A * (\beta_2 - \beta_1)$$

4. If  $\text{BETA} > B$ , the window is in sun. Otherwise, the window is in shade.

An Algorithm for Calculating Radiation Shape Factors  
Between Inside Surfaces of a Room

Definition of Room

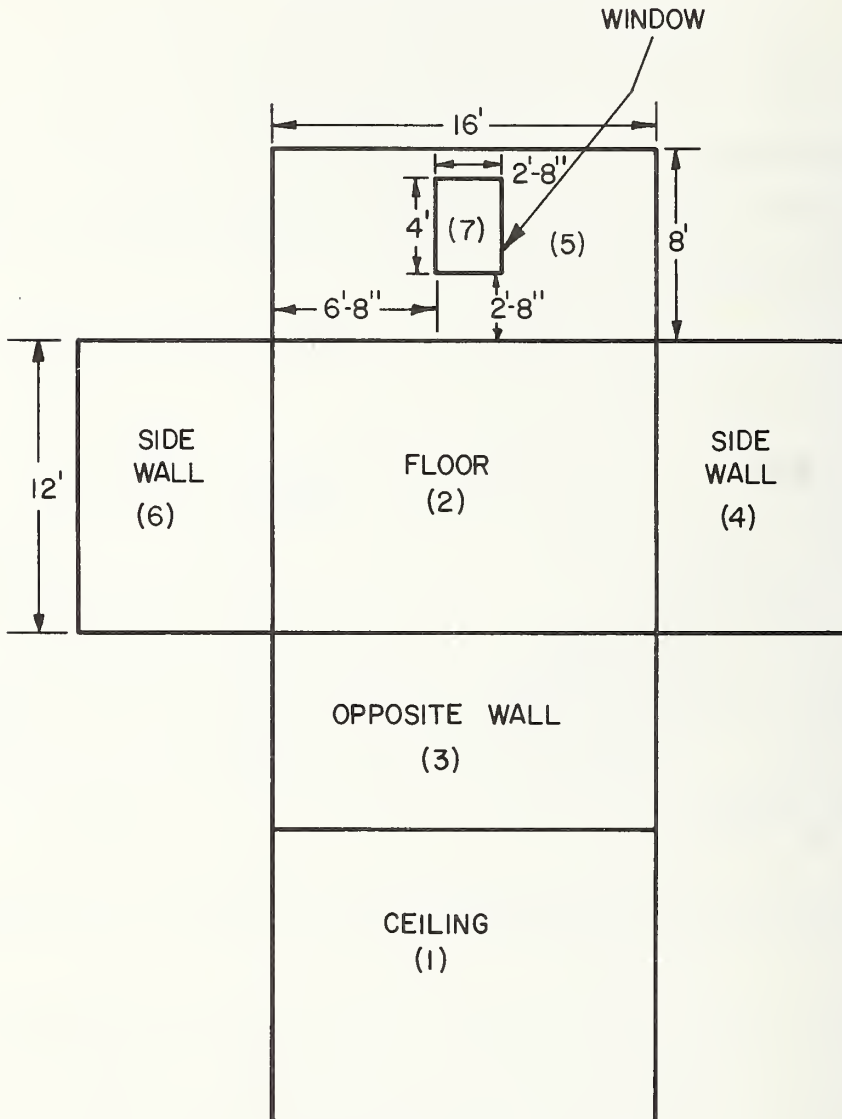

Figure A-10 Room Layout

\* This section was contributed by D. M. Burch and B. A. Peavy; Thermal Engineering Section, Center for Building Technology, National Bureau of Standards, Washington, D.C.

Data:

- L: Length of room
- W: Width of room
- H: Height of room
- A: Height of windows or doors
- B: Width of windows or doors
- C: Distance of left edge of window from left wall
- D: Height of lower edge of window from floor

The primary variables determined by this subroutine are:

$F_{m-n}$ : An array giving radiation shape factors between the various inside surfaces of a room

- m,n = 1 Ceiling
- 2 Floor
- 3 Wall No. 1 (length by height)
- 4 Wall No. 2 (side wall)
- 5 Wall No. 3 (opposite wall)
- 6 Wall No. 4 (side wall)
- 7-14 Provision for windows and doors in walls

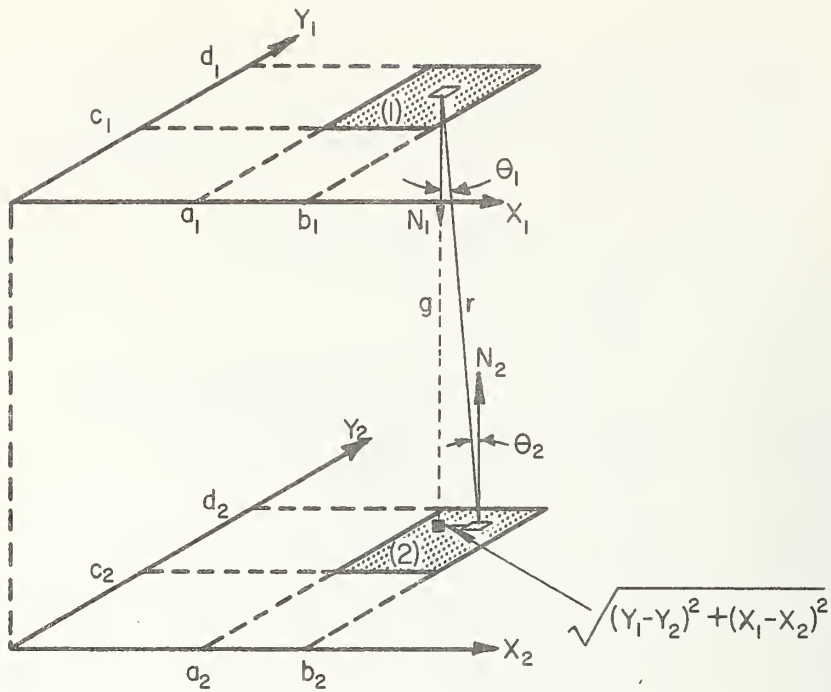

Figure A-11 Radiation Heat Exchange Between Ceiling and Floor Surfaces

Radiation shape factor,  $F_{1-2}$ , between two parallel room surfaces

$$2\pi(b_1 - a_1)(d_1 - c_1)F_{1-2} = [P(b_2 - b_1) + P(a_2 - a_1)] [Q(c_2 - c_1) + Q(d_2 - d_1) - Q(c_2 - d_1) - Q(d_2 - c_1)] \\ + [P(b_2 - a_1) + P(a_2 - b_1)] [Q(c_2 - d_1) + Q(d_2 - c_1) - Q(c_2 - c_1) - Q(d_2 - d_1)]$$

where

$$P(Z_1)Q(Z_2) = Z_1 W \tan^{-1} \frac{Z_1}{W} + Z_2 V \tan^{-1} \frac{Z_2}{V} - \frac{g^2}{2} \ln \frac{(W^2 + Z_1^2)}{W^2}$$

$$V^2 = g^2 + Z_1^2, \quad W^2 = g^2 + Z_2^2$$

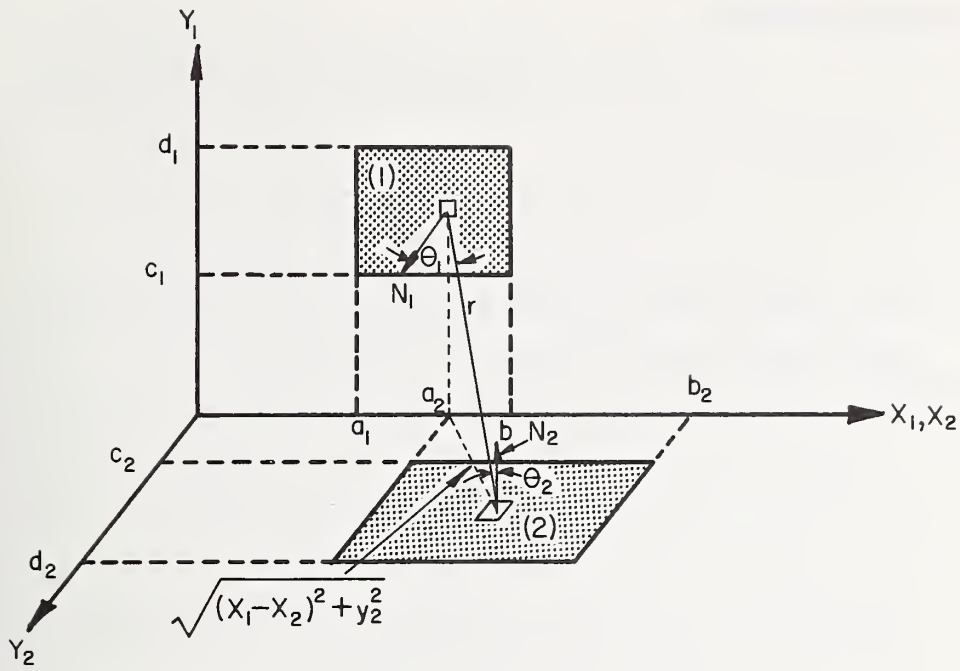

Figure A-12 Radiation Heat Exchange Between Wall and Floor Surfaces

Radiation Shape Factor,  $F_{1-2}$ , between two perpendicular room surfaces

$$2\pi(b_1 - a_1)(d_1 - c_1)F_{1-2} = [R(b_2 - b_1) + R(a_2 - a_1)] [S(c_2 + c_1) + S(d_2 + d_1) - S(c_2 + d_1) - S(d_2 + c_1)] \\ + [R(b_2 - a_1) + R(a_2 - b_1)] [S(c_2 + d_1) + S(d_2 + c_1) - S(c_2 + c_1) - S(d_2 + d_1)]$$

where

$$R(Z_1)S(Y_2 + Y_1) = TZ_1 \tan^{-1} \frac{Z_1}{T} + \frac{1}{4} (Z_1^2 - T^2) \ln (T^2 + Z_1^2)$$

$$T^2 = Y_2^2 + Y_1^2$$



Calculation Sequence:

1. Determine areas of ceiling, floor, and walls (no windows or doors),

$$A_m, m = 1, 2, 3, 4, 5, 6$$

2. Calculate radiation shape factor  $F_{m-n}$  for these surfaces using equations, and reciprocal relation

$$F_{m-n} = \frac{A_n}{A_m} F_{n-m}$$

3. Determine area of windows and doors and subtract from pertinent wall areas to give net wall areas
4. Calculate radiation shape factors from windows and/or doors to ceiling and/or floor using the above shape factor equations and the reciprocal relation. The radiation shape factors from a ceiling or floor surface to a window, door, or a wall area is given by

$$F_{m-n_k} = F_{m-n} - F_{m-n_1} - F_{m-n_2}$$

where k denotes the surface which is applicable for a receiving surface,  $A_n$  that has been subdivided into 2 or more surfaces.

5. Calculate radiation shape factors from windows and doors to walls using equations, above defined angle factor algebra and

$$A_k F_{m_k-n} = A_m F_{m-n} - A_{m_1} F_{m_1-n} - A_{m_2} F_{m_2-n}$$

which is applicable for a transmitting surface  $A_m$  that has been subdivided into 2 or more surfaces.

6. The resulting array  $F_{m-n}$  must be satisfied by the identity

$$\sum_{k=1}^p F_{m-k} = 1$$

where  $p$  is the number of surfaces visible to the transmitting surface  $A_m$

C THIS PROGRAM DETERMINES THE RADIATION SHAPE FACTORS FOR A ROOM  
 C OF ARBITRARY DIMENSIONS WITH THE PROVISION FOR TWO WINDOWS OR  
 C DOORS OF ANY SIZE AND POSITION ON EACH OF THE FOUR WALLS  
 C INPUT TO THE PROGRAM IS READ IN FIELDS OF NINE AND FIRST CARD IS

C LENGTH WIDTH HEIGHT

C THIS CARD IS FOLLOWED BY FOUR CARDS GIVING PERTINENT DIMENSIONS  
 C FOR WINDOWS AND DOORS - FIRST CARD IS FOR WINDOWS OR DOORS ON A  
 C WALL DEFINED ON THE LENGTH OF ROOM - SECOND CARD ON WIDTH, ETC.  
 C LEAVE SPACES BLANK IF THERE IS NO WINDOW OR DOOR

C	A	B	C	D	A	B	C	D
C	A	B	C	D	A	B	C	D
C	A	B	C	D	A	B	C	D
C	A	B	C	D	A	B	C	D

C WHERE A=HEIGHT OF WINDOW, C=CORNER OF WALL TO LEFT EDGE OF WINDOW  
 C B=WIDTH OF WINDOW, D=HEIGHT FROM FLOOR TO LOWER EDGE OF WINDOW  
 C OUTPUT CONSISTS OF ASSIGNMENT OF NUMBERS TO THE VARIOUS SURFACES  
 C OF THE ROOM

C	1	CEILING	LENGTH X WIDTH
C	2	FLOOR	LENGTH X WIDTH
C	3	WALL NO.1	LENGTH X HEIGHT
C	4	WALL NO.2	WIDTH X HEIGHT
C	5	WALL NO.3	LENGTH X HEIGHT
C	6	WALL NO.4	WIDTH X HEIGHT
C	7-14	WINDOW OR DOOR ON WALL NO.X	

C THIS IS FOLLOWED BY A PRINTOUT OF AN ARRAY OF RADIATION SHAPE FACTORS  
 C DIMENSION SF(14,14),A(8),B(8),C(8),D(8),S(14),X(5)  
 C DIMENSION IFIL(14),VF(14,14)

```

REAL L
READ(5,1)L,W,H
READ(5,1)(B(I),D(I),A(I),C(I),I=1,8)
1   FORMAT(8F9.2)
301  FORMAT(6X,28H LEGEND FOR ROOM ARRANGEMENT/40HUASSUME WALL NO. 1 I
1S ON THE ROOM LENGTH/7HOM OR N/4H  1,6X,10H CEILING  ,F6.2,4H BY
2,F6.2/4H  2,6X,10H FLOOR  ,F6.2,4H BY ,F6.2/4H  3,6X,10H WALL
3NO.1,F6.2,4H BY ,F6.2/4H  4,6X,10H WALL NO.2,F6.2,4H BY ,F6.2/4H
4  5,6X,10H WALL NO.3,F6.2,4H BY ,F6.2/4H  6,6X,10H WALL NO.4,F6.2
5,4H BY ,F6.2)
403  FORMAT(I4,6X,15H DOOR ON WALL,I2,4F11.2)
302  FORMAT(I4,6X,15H WINDOW ON WALL,I2,4F11.2)
303  FORMAT(6X,17H WINDOWS OR DOORS,13X,2H A,9X,2H B,9X,2H C,9X,2H D)
304  FORMAT(1H /8X,18H A - WINDOW HEIGHT/8X,17H B - WINDOW WIDTH/9X,48H
1C - DISTANCE OF LEFT EDGE OF WINDOW TO LEFT WALL/8X,46H D - HEIGHT
2 FROM FLOOR TO LOWER EDGE OF WINDOW)
WRITE (6,301) L,W,L,W,L,H,W,H,L,H,W,H
WRITE (6,303)
K=7
DO 305 I=1,8
IF(D(I).LT.1.E-8) GO TO 305
J=(I+1)/2
IC=C(I)*100.
IF(IC.EQ.0)GO TO 401
WRITE(6,302)K,J,D(I),B(I),A(I),C(I)
GO TO 402
401  WRITE(6,403)K,J,D(I),B(I),A(I),C(I)
402  CONTINUE
K=K+1

```

```

305  CONTINUE
      WRITE(6,304)
      DO 26 I=1,8
      B(I)=A(I)+B(I)
26   D(I)=C(I)+D(I)
      S(1)=W*L
      S(2)=S(1)
      DO 15 I=1,8
      S(I+6)=(B(I)-A(I))*(D(I)-C(I))
      IA=S(I+6)
      IF(IA.EQ.0)S(I+6)=1.0E-08
15   CONTINUE
      DO 14 I=1,5
      VAR=L
      IF(I.EQ.2.OR.I.EQ.4)VAR=W
14   X(I)=VAR
      DO 25 I=1,4
      IW=(I-1)*2+7
25   S(I+2)=X(I)*H
      DO 2 I=1,14
      DO 2 J=1,14
2   SF(I,J)=0.0
      SF(1,2)=PF(0.0,L,0.0,W,0.0,L,0.0,W,H)
      SF(1,3)=AF(0.0,L,0.0,W,0.0,L,0.0,H)
      SF(1,4)=AF(0.0,W,0.0,L,0.0,W,0.0,H)
      SF(1,5)=SF(1,3)
      SF(1,6)=SF(1,4)
      SF(2,1)=SF(1,2)*S(1)/S(2)
      SF(2,3)=SF(1,3)
      SF(2,4)=SF(1,4)
      SF(2,5)=SF(2,3)
      SF(2,6)=SF(2,4)
      SF(3,1)=SF(1,3)*S(1)/S(3)
      SF(3,2)=SF(2,3)*S(2)/S(3)
      SF(3,4)=AF(0.0,H,0.0,L,0.0,H,0.0,W)
      SF(3,5)=PF(0.0,L,0.0,H,0.0,L,0.0,H,W)
      SF(3,6)=SF(3,4)
      SF(4,1)=SF(1,4)*S(1)/S(4)
      SF(4,2)=SF(2,4)*S(2)/S(4)
      SF(4,3)=SF(3,4)*S(3)/S(4)
      SF(4,5)=SF(4,3)
      SF(4,6)=PF(0.0,W,0.0,H,0.0,W,0.0,H,L)
      SF(5,1)=SF(1,5)*S(1)/S(5)
      SF(5,2)=SF(2,5)*S(2)/S(5)
      SF(5,3)=SF(3,5)*S(3)/S(5)
      SF(5,4)=SF(4,5)*S(4)/S(5)
      SF(5,6)=SF(5,4)
      SF(6,1)=SF(1,6)*S(1)/S(6)
      SF(6,2)=SF(2,6)*S(2)/S(6)
      SF(6,3)=SF(3,6)*S(3)/S(6)
      SF(6,4)=SF(4,6)*S(4)/S(6)
      SF(6,5)=SF(5,6)*S(5)/S(6)
      DO 250 I=1,4
      IW=(I-1)*2+7
250  S(I+2)=S(I+2)-S(IW)-S(IW+1)
      DO 3 K=1,4
      J=(K-1)*2
      DO 5 I=1,2
      N=I+J
      N6=N+6
      SF(N6,2)=AF(A(N),B(N),C(N),D(N),0.0,X(K),0.0,X(K+1))
      SF(N6,1)=AF(A(N),B(N),H-D(N),H-C(N),0.0,X(K),0.0,X(K+1))

```

```

SF(2,N6)=SF(N6,2)*S(N6)/S(2)
5 SF(1,N6)=SF(N6,1)*S(N6)/S(1)
SF(2,2+K)=SF(2,2+K)-SF(2,J+7)-SF(2,J+8)
SF(1,2+K)=SF(1,2+K)-SF(1,J+7)-SF(1,J+8)
3 SF(2+K,2)=SF(2,2+K)*S(2)/S(2+K)
SF(2+K,1)=SF(1,2+K)*S(1)/S(2+K)
DO 8 K=1,2
N=(K-1)*2
SUM=0.0
DO 6 J=1,2
NJ=N+J
NJ6=NJ+6
SF(NJ6,K+4)=PF(A(NJ),B(NJ),C(NJ),D(NJ),0.0,X(K),0.0,H,X(K+1))
SUM=SUM+S(NJ6)*SF(NJ6,K+4)
DO 6 I=1,2
NI=N+I+4
NI6=NI+6
SF(NJ6,NI6)=PF(A(NJ),B(NJ),C(NJ),D(NJ),X(K)-B(NI),X(K)-A(NI),C(NI)
1,D(NI),X(K+1))
6 SF(NI6,NJ6)=SF(NJ6,NI6)*S(NJ6)/S(NI6)
DO 7 I=1,2
NI=N+I+4
NI6=NI+6
7 SF(NI6,K+2)=PF(A(NI),B(NI),C(NI),D(NI),0.0,X(K),0.0,H,X(K+1))
SF(N+7,K+4)=SF(N+7,K+4)-SF(N+7,N+11)-SF(N+7,N+12)
SF(N+8,K+4)=SF(N+8,K+4)-SF(N+8,N+11)-SF(N+8,N+12)
SF(N+11,K+2)=SF(N+11,K+2)-SF(N+11,N+7)-SF(N+11,N+8)
SF(N+12,K+2)=SF(N+12,K+2)-SF(N+12,N+7)-SF(N+12,N+8)
SF(K+4,N+7)=SF(N+7,K+4)*S(N+7)/S(K+4)
SF(K+4,N+8)=SF(N+8,K+4)*S(N+8)/S(K+4)
SF(K+2,N+11)=SF(N+11,K+2)*S(N+11)/S(K+2)
SF(K+2,N+12)=SF(N+12,K+2)*S(N+12)/S(K+2)
SF(K+2,K+4)=(X(K)*H*SF(K+2,K+4)-SUM)/S(K+2)
SF(K+2,K+4)=SF(K+2,K+4)-SF(K+2,N+11)-SF(K+2,N+12)
8 SF(K+4,K+2)=SF(K+2,K+4)*S(K+2)/S(K+4)
DO 9 K=1,4
IT=K+3
IF(K.EQ.4)IT=3
IW=(K-1)*2
SUM=0.0
DO 10 I=1,2
IK=IW+I
IK6=IK+6
SF(IK6,IT)=AF(C(IK),D(IK),X(K)-B(IK),X(K)-A(IK),0.0,H,0.0,X(K+1))
SUM=SUM+S(IK6)*SF(IK6,IT)
DO 10 J=1,2
IM=J+IW+2
IF(K.EQ.4)IM=J
IM6=IM+6
SF(IK6,IM6)=AF(C(IK),D(IK),X(K)-B(IK),X(K)-A(IK),C(IM),D(IM),A(IM)
1,B(IM))
10 SF(IM6,IK6)=SF(IK6,IM6)*S(IK6)/S(IM6)
DO 11 I=1,2
IL=IW+2+I
IF(K.EQ.4)IL=I
IL6=IL+6
11 SF(IL6,K+2)=AF(C(IL),D(IL),A(IL),R(IL),0.0,H,0.0,X(K))
IW7=IW+7
IAC=IW7+2
IWL=K+3
IF(K.NE.4)GO TO 12
IWL=3
IAC=7

```



```

12  IK=K+2
    SF(IW7,IWL)=SF(IW7,IWL)-SF(IW7,IAC)-SF(IW7,IAC+1)
    SF(IW7+1,IWL)=SF(IW7+1,IWL)-SF(IW7+1,IAC)-SF(IW7+1,IAC+1)
    SF(IAC,IK)=SF(IAC,IK)-SF(IAC,IW7)-SF(IAC,IW7+1)
    SF(IAC+1,IK)=SF(IAC+1,IK)-SF(IAC+1,IW7)-SF(IAC+1,IW7+1)
    SF(IWL,IW7)=SF(IW7,IWL)*S(IW7)/S(IWL)
    SF(IWL,IW7+1)=SF(IW7+1,IWL)*S(IW7+1)/S(IWL)
    SF(IK,IAC)=SF(IAC,IK)*S(IAC)/S(IK)
    SF(IK,IAC+1)=SF(IAC+1,IK)*S(IAC+1)/S(IK)
    KAC=IK+1
    IF(K.EQ.4)KAC=3
    SF(IK,KAC)=(X(K)*H*SF(IK,KAC)-SUM)/S(IK)
    SF(IK,KAC)=SF(IK,KAC)-SF(IK,IAC)-SF(IK,IAC+1)
9   SF(KAC,IK)=SF(IK,KAC)*S(IK)/S(KAC)
    NP=0
    DO 52 I=1,14
    IB=SF(I,1)*1000.
    IF(I.EQ.1)IB=1
    IF(IB.EQ.0)GO TO 52
    NP=NP+1
    IFIL(NP)=I
52  CONTINUE
    DO 16 I=1,NP
    DO 16 J=1,NP
    NI=IFIL(I)
    NJ=IFIL(J)
16  VF(I,J)=SF(NI,NJ)
    WRITE(6,307)
307  FORMAT(1H /4X,44H ARRAY FOR SHAPE FACTORS FROM SURFACE M TO N/1H )
17  FORMAT(4H M/N,I5,13I7)
    DO 18 I=1,NP
18  WRITE(6,19)(I,(VF(I,J),J=1,NP))
19  FORMAT(1X,I2,1X,14F7.5)
    STOP
    END

```

```

C   FUNCTION PF(A1,B1,C1,D1,A2,B2,C2,D2,G)
C   THIS FUNCTION SUBPROGRAM CALCULATES THE SHAPE FACTOR FROM A
C   PLANE RECTANGULAR SURFACE TO ANOTHER PARALLEL PLANE
C   RECTANGULAR SURFACE.
    S=(B1-A1)*(D1-C1)
    IP=S*10.
    IF(IP.NE.0)GO TO 1
    PF=0.0
    RETURN
1   F=F1(B1,D1,B2,D2,G)-F1(B1,D1,B2,C2,G)
    1-F1(B1,D1,A2,D2,G)+F1(B1,D1,A2,C2,G)
    2-F1(B1,C1,B2,D2,G)+F1(B1,C1,B2,C2,G)
    3+F1(B1,C1,A2,D2,G)-F1(B1,C1,A2,C2,G)
    4-F1(A1,D1,B2,D2,G)+F1(A1,D1,B2,C2,G)
    5+F1(A1,D1,A2,D2,G)-F1(A1,D1,A2,C2,G)
    6+F1(A1,C1,B2,D2,G)-F1(A1,C1,B2,C2,G)
    7-F1(A1,C1,A2,D2,G)+F1(A1,C1,A2,C2,G)
    PF=F/(3.1415927*S)
    RETURN
    END

```



```

FUNCTION F1(X1,Y1,X2,Y2,G)
U=X2-X1
V=Y2-Y1
UU=SQRT(G*G+U*U)
VV=SQRT(G*G+V*V)
WW=(G*G+U*U+V*V)/(G*G+V*V)
FI=U*VV*ATAN(U/VV)+V*UU*ATAN(V/UU)-G*G*LOG(WW)/2.
F1=FI/2.
RETURN
END

```

```

FUNCTION AF(A1,B1,C1,D1,A2,B2,C2,D2)
C THIS FUNCTION SUBPROGRAM CALCULATES THE SHAPE FACTOR FROM A
C PLANE RECTANGULAR SURFACE OF A ROOM TO ANOTHER PERPENDICULAR
C PLANE RECTANGULAR SURFACE.
S=(B1-A1)*(D1-C1)
IP=S*10.
IF(IP.NE.0) GO TO 1
AF=0.0
RETURN
1 F=F2(A1,C1,A2,C2)+F2(B1,D1,B2,D2)
1-F2(A1,D1,B2,D2)-F2(B1,D1,B2,C2)
2+F2(A1,D1,B2,C2)-F2(B1,D1,A2,D2)
3+F2(A1,D1,A2,D2)+F2(B1,D1,A2,C2)
4-F2(A1,D1,A2,C2)-F2(B1,C1,B2,D2)
5+F2(A1,C1,B2,D2)+F2(B1,C1,B2,C2)
6-F2(A1,C1,B2,C2)+F2(B1,C1,A2,D2)
7-F2(A1,C1,A2,D2)-F2(B1,C1,A2,C2)
AF=F/(3.1415927*S)
RETURN
END

```

```

FUNCTION F2(X1,Y1,X2,Y2)
U=X2-X1
V=Y1**2+Y2**2
IF(ABS(U**2+V).LE.1.0E-7) GO TO 1
GO TO 2
1 F2=0.0
GO TO 3
2 IF(V.LE.1.0E-7) GO TO 4
GO TO 5
4 F2=.5*U**2*LOG(U**2)
GO TO 3
5 F2=.5*(U**2-V)*LOG(U**2+V)+2*U*SQRT(V)*ATAN(U/SQRT(V))
3 F2=F2/4.
RETURN
END

```

LEGEND FOR ROOM ARRANGEMENT

ASSUME WALL NO. 1 IS ON THE ROOM LENGTH

M OR N

1	CEILING	16.00	BY	12.00
2	FLOOR	16.00	BY	12.00
3	WALL NO.1	16.00	BY	8.00
4	WALL NO.2	12.00	BY	8.00
5	WALL NO.3	16.00	BY	8.00
6	WALL NO.4	12.00	BY	8.00

	WINDOWS OR DOORS		A	B	C	D
7	WINDOW ON WALL 2	4.00		2.67	6.67	2.67
8	WINDOW ON WALL 3	4.00		2.67	6.67	2.67

A - WINDOW HEIGHT

B - WINDOW WIDTH

C - DISTANCE OF LEFT EDGE OF WINDOW TO LEFT WALL

D - HEIGHT FROM FLOOR TO LOWER EDGE OF WINDOW

ARRAY FOR SHAPE FACTORS FROM SURFACE M TO N

M/N	1	2	3	4	5	6	7	8
1	.00000	.36405	.18326	.11766	.16504	.13472	.01706	.01822
2	.36405	.00000	.18326	.12078	.16824	.13472	.01394	.01501
3	.27488	.27488	.00000	.12759	.15887	.13715	.00956	.01706
4	.26473	.27176	.19139	.00000	.16715	.09464	.00000	.01033
5	.27006	.27531	.17332	.12157	.00000	.14066	.01909	.00000
6	.26944	.26944	.18286	.08412	.17192	.00000	.01127	.01095
7	.30709	.25086	.11468	.00000	.21001	.10144	.00000	.01592
8	.32793	.27026	.20474	.08261	.00000	.09853	.01592	.00000

An Algorithm for Calculating Radiation Shape Factors Between Attic Surfaces Where the Attic Has a Gabled Room

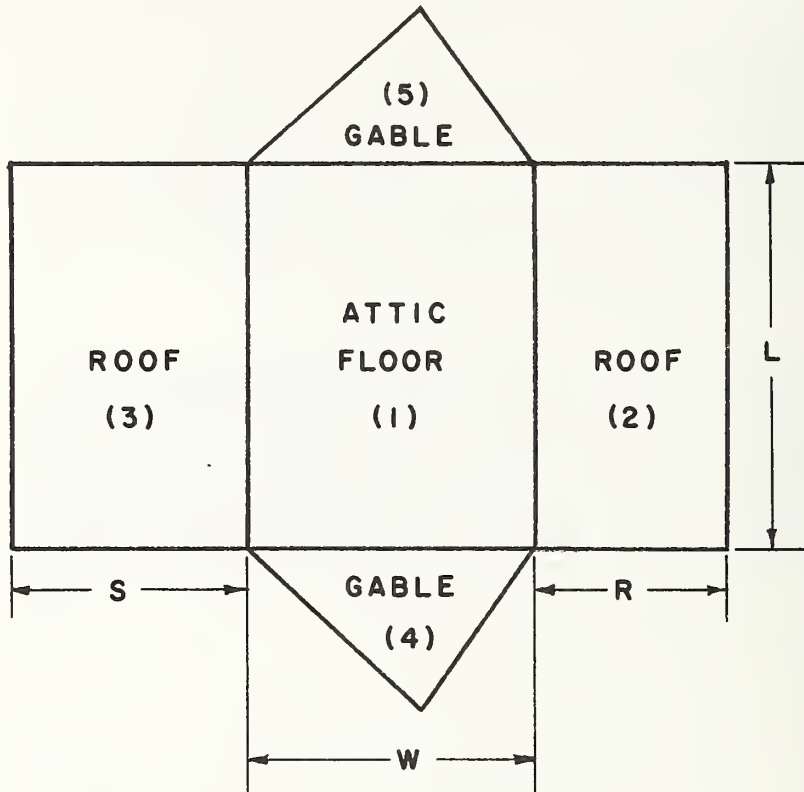

Figure A-13 Definitions of Attic Enclosure

Data:

$L$  = Length of attic floor

$W$  = Width of attic

\* This section was contributed by B. A. Peavy and D. M. Burch, Thermal Engineering Systems Section, Center for Building Technology, National Bureau of Standards, Washington, D. C. 20234.

The primary variables determined by this subroutine are:

$F_{m-n}$  = An array giving radiation shape factors between the various inside surfaces of an attic with a gabled roof

m, n = 1 attic floor (1)

2 roof area (2)

3 roof area (3)

4 front gable (4)

5 rear gable (5)

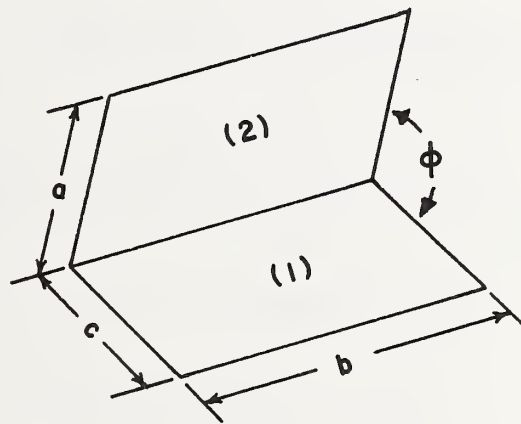

Figure A-14 Radiation Heat Exchange Between Two Adjacent Surfaces

$$X = \frac{a}{b}, Y = \frac{c}{b}, Z^2 = X^2 + Y^2 - 2XY \cos \phi$$

$$\begin{aligned}
\pi Y F_{1-2} = & - \frac{\sin 2\phi}{4} \left\{ XY \sin\phi + \left( \frac{\pi}{2} - \phi \right) (X^2 + Y^2) \right. \\
& + Y^2 \tan^{-1} \left( \frac{X - Y \cos\phi}{Y \sin\phi} \right) + X^2 \tan^{-1} \left( \frac{Y - X \cos\phi}{X \sin\phi} \right) \left. \right\} \\
& + \frac{\sin^2 \phi}{4} \left\{ \left( \frac{2}{\sin^2 \phi} - 1 \right) \ln \left[ \frac{(1 + X^2)(1 + Y^2)}{1 + Z^2} \right] \right. \\
& + Y^2 \ln \left[ \frac{Y^2 (1 + Z^2)}{(1 + Y^2) Z^2} \right] + X^2 \cos 2\phi \ln \left[ \frac{1 + X^2}{1 + Z^2} \right] + 2X^2 \ln \frac{X}{Z} \left. \right\} \\
& + Y \tan^{-1} \left( \frac{1}{Y} \right) + X \tan^{-1} \left( \frac{1}{X} \right) - Z \tan^{-1} \left( \frac{1}{Z} \right) \\
& + \frac{\sin\phi \sin 2\phi}{2} X \sqrt{1 + X^2 \sin^2 \phi} \left\{ \tan^{-1} \left[ \frac{Y (1 + X^2 \sin^2 \phi)}{1 + X^2 - XY \cos\phi} \right] \right\} \\
& + \cos\phi \int_0^Y \sqrt{1 + \lambda^2 \sin^2 \phi} \left\{ \tan^{-1} \left[ \frac{X (1 + \lambda^2 \sin^2 \phi)}{1 + \lambda^2 - \lambda X \cos\phi} \right] \right\} d\lambda
\end{aligned} \tag{1}$$

$$\sum_{m=1}^5 F_{n-m} = 1 \tag{2}$$

$$F_{n-m} = \frac{A_m F_{m-n}}{A_n} \tag{3}$$

$A_m$  is area of surface  $m$

Calculation Sequence:

1.  $X = R/L, Y = W/L, \phi_1 = \cos^{-1} \left( \frac{W^2 + R^2 - S^2}{2WR} \right)$

Compute  $F_{1-2}, F_{2-1}$  [Equations (1) and (3)]

2. If  $S = R, \phi_2 = \phi_1, F_{1-3} = F_{1-2}, F_{3-1} = F_{2-1}$ , skip stage 3

3.  $X = S/L, Y = W/L, \phi_2 = \cos^{-1} \left( \frac{W^2 + S^2 - R^2}{2WS} \right)$

Compute  $F_{1-3}, F_{3-1}$  [Equations (1) and (3)]

4.  $X = S/L, Y = R/L, \phi_3 = \pi - \phi_1 - \phi_2$

Compute  $F_{2-3}, F_{3-2}$  [Equations (1) and (3)]

5.  $F_{m-4}, F_{m-5}, m = 1, 2, 3$  [Equation (2)]

6.  $F_{4-m}, F_{5-m}, m = 1, 2, 3$  [Equation (3)]

7.  $F_{4-5}, F_{5-4}$  [Equation (2)]



FI

An Algorithm for Approximating Inside Surface Heat Transfer  
Coefficients Tabulated in Table 1, Page 357 of the 1972  
ASHRAE Handbook of Fundamentals

Data:

IDIR: Heat flow direction index

	1	Upward
	2	45° upward
IDIR =	3	Horizontal
	4	45° downward
	5	Downward

$\epsilon$ : Emittance of the surface

IV: Moving air index (IV = 0 corresponds to still air)

Calculation Sequence:

1. If IV = 0,  $FI = h_c + 1.02*\epsilon$

where

	.712		1
	.682		2
$h_c =$	.542	for IDIR =	3
	.402		4
	.162		5

2. If IV  $\neq$  0,  $FI = 2.0$  Btu per (hr) (sq ft) (F)

FO

An Algorithm for Determining Outside Surface Heat Transfer  
Coefficient As a Function of Air Velocity and the Type  
of Surface Constructions

Data:

V: Wind velocity, knots (Determined in CLIMATE)

DIR: Wind direction (Determined in CLIMATE)

IS: Outside surface index

IS =

1	Stucco
2	Brick and rough plaster
3	Concrete
4	Clear pine
5	Smooth plaster
6	Glass, white paint on pine

WA: Wall azimuth angle, degree

Calculation Sequence:

1. Conversion of the unit of wind velocity from knots into mph

$$V' = 1.153 * V$$

2. Outside surface heat transfer coefficient

$$FO = A * (V'^{**2}) + B * V' + C$$

where A, B and C are given in Table A-8

Table A-8

Value of Coefficients For Calculation  
of Outside Heat Transfer Coefficient

IS	A	B	C
1	0.0	0.464	2.04
2	0.001	0.320	2.20
3	0.0	0.330	1.90
4	-0.002	0.315	1.45
5	0.0	0.244	1.80
6	-0.00125	0.262	1.45

## 3. Relative wind direction to the wall surface

$$RWD = WA + 180 - DIR$$

$$\text{If } |RWD| > 180, RWD = 360 - RWD$$

## 4. Conversion of the unit of wind velocity into m per sec

$$VV = 0.51479 * V$$

## 5. Air velocity close to wall surface

$$\text{If } |RWD| < 90 \text{ (windward)}$$

$$VC = 0.25 * VV \quad \text{for } VV > 2$$

$$VC = 0.5 \quad \text{for } VV \leq 2$$

$$\text{If } |RWD| \geq 90 \text{ (leeward)}$$

$$VC = 0.3 + 0.05 * VV$$

6. Convection component of the outside surface heat transfer coefficient

$$FOC = 3.28 * ((VC)**0.605)*$$

---

\* This equation was derived by K. Kimura based upon the recent data published in Reference 6.

ACR\*

An Algorithm for Determining Thermal Resistance  
Across the Air Cavity in Walls and Roofs

Data:

DT: Temperature difference across the air space, F

L: Thickness of the air space, in.

IDIR: Heat flow direction index

1 upward

2 45° upward

IDIR = 3 horizontal

4 45° downward

5 downward

$\epsilon_1, \epsilon_2$ : Emittance of the surfaces facing the air cavity

ATC: Average temperature of the air cavity, F

Calculation Sequence:

1. Let  $x = \text{Log} (DT * (L^{**3}))$

Then using the values for  $A_0, A_1, A_2, A_3,$  and  $A_4$  which are given in Table A-9, calculate

$$y = A_0 + A_1 * x + A_2 * (x ** 2) + A_3 * (x ** 3) + A_4 * (x ** 4)^{*/}$$

---

\* This polynomial has been derived to represent experimental data presented in Figure 6 of Reference 7 and shown here in Figure A-15.

Table A-9 VALUES OF  $A_0$ ,  $A_1$ ,  $A_2$ ,  $A_3$ , and  $A_4$  FOR CALCULATION OF RESISTANCE ACROSS THE AIR SPACE

IDIR	Range of $DT*(L^{**3})$	$A_0$	$A_1$	$A_2$	$A_3$	$A_4$
11	All the range	-1.5904	0.2824	0.0	0.0	0.0
22	$1 < DT*(L^{**3}) < 10$	-1.7125	-0.0875	0.2437	-0.0420	0.0
	$10 < DT*(L^{**3}) < 100$	-1.8546	0.3124	0.0	0.0	0.0
	$100 < DT*(L^{**3})$	-1.7380	0.2910	0.0	0.0	0.0
3	$1 < DT*(L^{**3}) < 10$	-1.7410	-0.0331	0.0198	-0.0146	0.0
	$10 < DT*(L^{**3}) < 100$	1.0460	-3.4660	1.5482	-0.2669	0.01673
	$100 < DT*(L^{**3})$	-0.2141	-0.6577	0.1693	-0.0095	0.0
4	$1 < DT*(L^{**3}) < 10$	-1.7420	0.0163	-0.0409	0.0204	0.0
	$10 < DT*(L^{**3}) < 100$	-6.5410	5.5710	-2.3690	0.4467	-0.0300
	$100 < DT*(L^{**3})$	-0.1914	6.1610	-1.3390	0.1339	-0.0050
5	$1 < DT*(L^{**3}) < 10$	-1.770	0.0	0.0	0.0	0.0
	$10 < DT*(L^{**3})$	-1.745	0.0028	0.0029	0.0008	0.0

2. Let  $z = \text{Exp}(y)$

$$\text{If } z > 0.3 \quad h_c = z * (1 - 0.001 * (DT-50))/L$$

$$\text{If } 0.2 \leq z \leq 0.3 \quad h_c = z * (1 + 0.00035 * (DT-50))/L$$

$$\text{If } z < 0.2 \quad h_c = z * (1 + 0.0017 * (DT-50))/L$$

$$3. h_r = 0.00686 * (((ATC + 460)/100) ** 3)*$$

$$4. RES = 1/(h_c + (1/(1/\epsilon_1 + 1/\epsilon_2 - 1)) * h_r)$$

\* This polynomial has been derived to represent the curve presented in Figure 5 of Reference 7 and shown here in Figure A-16.



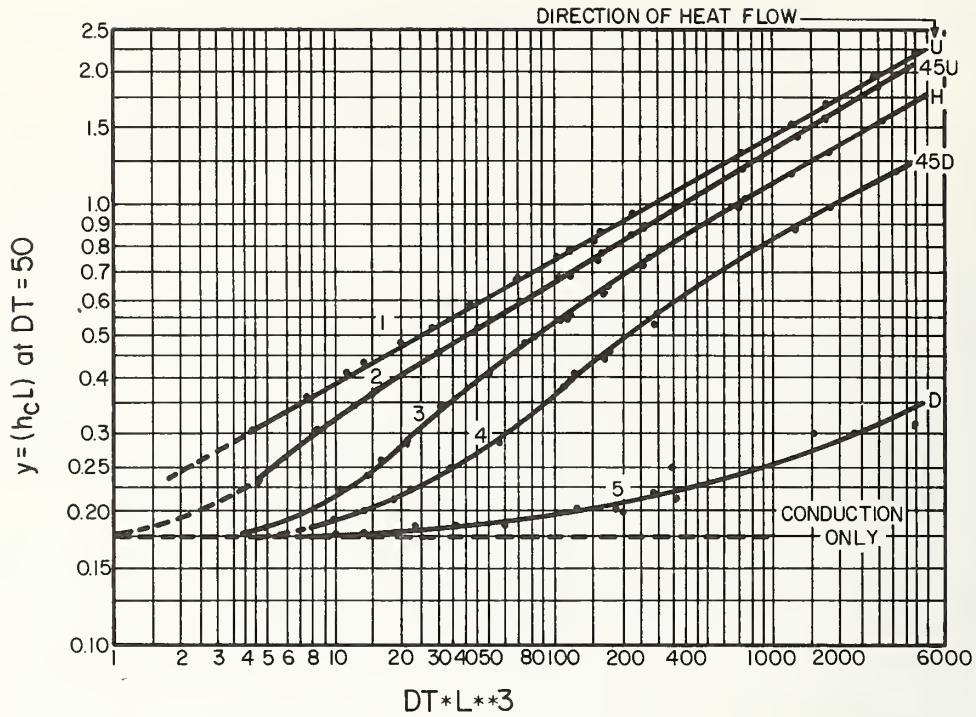

Figure A-15 Convection-Conduction Coefficient for Heat Transfer Across an Air Space for Five Orientations of the Air Space and Directions of Heat Flow

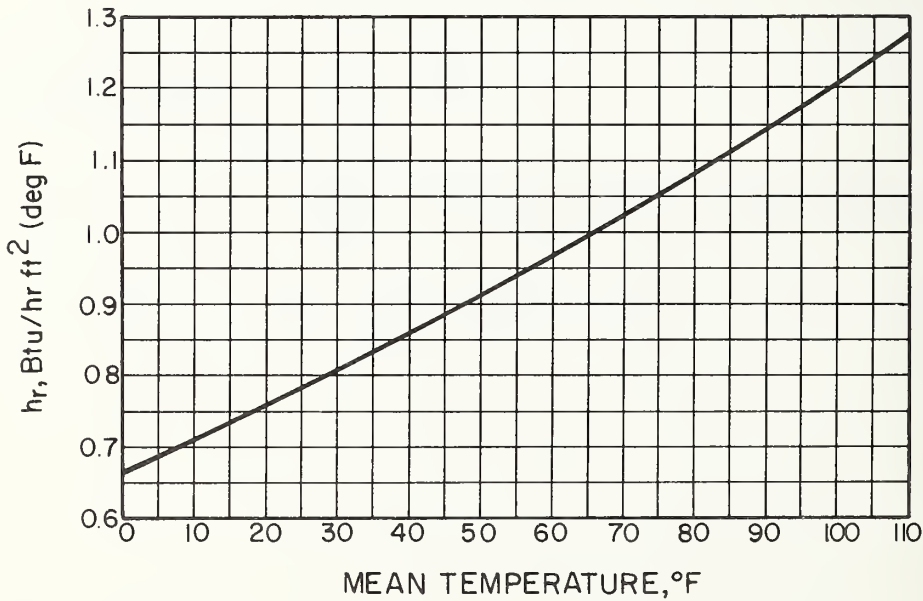

Figure A-16 Linear Radiation Coefficient for Heat Transfer Across an Air Space for a Radiation Interchange Factor

A Description of the Calculation Procedure for Transient  
Heat Conduction Using Conduction Transfer Functions

Conduction transfer functions are used widely and considered as a convenient and effective tool for the evaluation of transient heat transfer in building construction components. The conventional steady state heat transfer equation for calculating heat loss:

$$Q = U * (T_a - T_o) \quad (1)$$

where

U: overall heat transfer coefficient of roof or wall

T<sub>a</sub>: inside air temperature

T<sub>o</sub>: outside air temperature

is not sufficient for evaluating transient heat transfer. This equation becomes invalid because the outdoor temperature T<sub>o</sub> usually varies as affected by solar radiation, cloud cover and wind effect. The effect of the rapid change of the outdoor temperature will not be accounted for unless the structure is extremely lightweight, such as galvanized steel.

Approximate calculation for a more accurate determination of the instantaneous heat transfer can be made by replacing T<sub>a</sub> - T<sub>o</sub> of equation (1) by a Total Equivalent Temperature Difference (TETD) which is usually precalculated for typical building construction components and takes into account the thermal storage effect. Although very useful, the TETD concept is only valid when the outside temperature T<sub>o</sub> undergoes steady periodic changes. The TETD concept is therefore especially useful computing design heat transfer rates for the building where very warm or very cold

conditions are assumed to occur for several successive days.

A more accurate formulation for conduction heat transfer from a room to randomly fluctuating outdoor conditions is to use the hourly history of temperatures in conjunction with Conduction Transfer Functions (CTF). For example, in calculating the energy transfer from a room at an inside surface, the equation would be:

$$Q_{i,t} = \sum_{j=0}^N X_j * T_{a,t-j} - \sum_{j=0}^N Y_j * T_{o,t-j} + R * Q_{t-1} \quad (2)$$

where  $X_j$ ,  $Y_j$  (for  $j = 0, 1, 2 \dots N$ ), and  $R$  are the Conduction Transfer Functions. In equation (2),  $T_{o,t-j}$  and  $T_{a,t-j}$  represent outdoor and room air temperatures respectively at  $j$ th hour prior to the time for which the value of  $Q_t$  is needed. And  $Q_{t-1}$  is the heat loss  $Q_t$ , from the room at the previous hour. By having a record of  $T_{o,t-1}$ ,  $T_{o,t-2}$ ,  $T_{o,t-3} \dots T_{o,t-j}$ ; and  $T_{a,t-1}$ ,  $T_{a,t-2} \dots T_{a,t-j}$ ; it is possible to determine the instantaneous conduction transfer, provided that the values for  $X_j$  and  $Y_j$ , and  $R$  are available.

The number of terms involved for the calculation of  $Q_t$  (or the value of  $N$  in equation (2)) depends upon the type of roof or wall construction. Generally heavy constructions require a large value, although for most conventional constructions, it seldom exceeds 20. Stephenson and Mitalas<sup>8/</sup> have shown that the value of  $N$  can be further decreased by employing more than one past record of  $Q_t$  (or  $Q_{t-j}$  with  $j$  being more than 1) in the following manner:

$$Q_{i,t} = \sum_{j=0}^{N'} A_j * T_{a,t-j} - \sum_{j=0}^{N'} B_j * T_{o,t-j} - \sum_{j=1}^N D_j * Q_{i,t-j} \quad (3)$$

where  $A_j$ ,  $B_j$ , and  $D_j$  are the Modified Conduction Transfer Functions according to Stephenson and Mitalas<sup>8/</sup>. Table A-10 gives values of Conduction Transfer Functions calculated for a brick wall having an overall heat transfer coefficient of 0.418. In this table, the factors designated by  $Z_j$  and  $C_j$  are the additional transfer function to be used for evaluating the instantaneous heat loss  $Q_{o,t}$  at the exterior side of the structure. The applicable equations for this side of the structure are then:

$$Q_{o,t} = \sum_{j=0}^N Y_j * T_{a,t-j} - \sum_{j=0}^N Z_j * T_{o,t-j} + R * Q_{o,t-1} \quad (4)$$

or

$$Q_{o,t} = \sum_{j=0}^{N'} B_j * T_{a,t-j} - \sum_{j=0}^{N'} C_j * T_{o,t-j} - \sum_{j=1}^{N'} D_j * Q_{o,t-j} \quad (5)$$

The table also shows that for the calculation of  $Q_{o,t}$  the use of Stephenson type transfer functions would permit the reduction of  $N$  from 10 to  $N' = 4$  with a corresponding increase of three terms in the past record of  $Q_{o,t}$ .

Table A-10

Construction Data	Thermal	Density	Specific	Thermal
Thickness	Conductivity	Density	Heat	Resistance
(f)	Btuh/ft	lb/ft <sup>3</sup>	Btu/lb °F	sq ft hr
				F/Btu
Inside Surface	0.000	--	--	.830
4-in common brick	0.333	.420	100.42	.793
4-in face brick	0.333	.770	125.00	0.432
Outside surface	0.000	--	--	.330
				<hr/>
				2.385
Time increment: 1 hour				
Overall heat transfer coefficient U = 0.418				

## Conduction Transfer Functions (CTF)

j	X <sub>j</sub>	Y <sub>j</sub>	Z <sub>j</sub>	R
0	.9194	.0001	1.9833	0.8398
1	-.9391	.0080	-2.1785	
2	.0606	.0243	.1983	
3	.0153	.0186	.0387	
4	.0061	.0090	.0144	
5	.0026	.0039	.0060	
6	.0011	.0017	.0026	
7	.0005	.0007	.0011	
8	.0002	.0003	.0005	
9	.0001	.0001	.0002	
10	.0000	.0001	.0001	

## Stephenson Type Transfer Functions

j	A <sub>j</sub>	B <sub>j</sub>	C <sub>j</sub>	D <sub>j</sub>
0	0.9194	0.0001	1.9833	1.000
1	-1.4128	0.0079	-3.2002	-1.3552
2	0.5785	0.0202	1.3942	0.4699
3	-0.0511	0.0064	-0.1448	0.0315
4	0.0007	0.0002	0.0024	0.0002



Data:

- NL: Number of layers to be considered for the analysis of a given structure: the number of layers should include surface resistance or air cavity resistance if they contribute significantly to the overall heat transfer of that particular structure
- $K_i$ : Thermal conductivity of i-th layer in Btu per (hr) (ft) (F). This value is not needed for air cavities or for the surface resistance layers.
- $\rho_i$ : Density of i-th layer in lb per (cu. ft). This value is not needed for air cavities or for the surface resistance layers.
- $C_i$ : Specific heat of i-th layer material in Btu per (lb) (F). This value is not needed for air cavities or for the surface resistance layers.
- $L_i$ : Thickness of the i-th layer in ft. This value is not needed for the air cavities or for the surface resistance layers.
- RES<sub>i</sub>: Thermal resistance of air cavities and surface resistance layers in (hr) (sq ft) (F) per Btu. This value is not needed whenever all of the remaining values such as  $K_i$ ,  $\rho_i$ ,  $C_i$  and  $L_i$  are given.



DT: Time increment for the conduction transfer functions  
in hr (usually one hour for the building heat transfer calculations)

Subscript  $i$  refers to  $i$ -th layer and it varies from 1 to NL.

The sequence of inputting the above property values for each layer is very important and must be consistent with the particular convention adopted for the specific calculation routine. The sequence must follow in order from the inside layer to the outside layer or vice versa. It should be noted that the inclusion of the surface thermal resistance as independent layers is optional depending upon the end use of the conduction transfer functions. If the inside surface temperature is to be computed as a balance of all the heat flow involved at that surface, the thermal resistance of the inside surface should not be included in the calculation of the conduction transfer functions. The same comment applies for the outside surface.

An algorithm for the calculation of the conduction heat transfer functions will not be given here, since it involves lengthy mathematical solutions to the standard transient heat conduction differential equation. Reference (9) provides an excellent background for this calculation. Several computer programs<sup>10, 11/</sup> are available for the calculation of conduction transfer functions for multi-layer walls, roofs and floor constructions. The program developed by the National Research Council of Canada<sup>10/</sup> requires the layer input to be placed in order from outside toward inside. It calculates the Stephenson type conduction transfer

functions directly. The program of the National Bureau of Standards<sup>11/</sup> requires the input to be placed from the inside layer first and calculates the conduction transfer functions of plane, cylindrical and spherical walls. It also calculates the transfer functions for solid objects of plane, cylindrical and spherical shapes as well as the heat conduction systems involving semi-infinite solids, approximated by basement floors and underground constructions.

Under non-steady heat conduction, the heat lost from one side of a surface is not equal to the rate of heat entry at another side. Equations (2) and (3), however, must be valid also for the steady state heat transfer problems. One of the best ways to check the consistency of the conduction transfer functions is to use them in the solution of steady state problems and see if the following criteria is met: The room side surface temperature and the outdoor side surface temperature are maintained constant for many hours so that

$$\begin{aligned} TOS_t &= TOS_{t-1} = \dots\dots\dots TOS_{t-N} \\ TIS_t &= TIS_{t-1} = \dots\dots\dots TIS_{t-N} \\ QI_t &= QO_t = QO_{t-1} = QI_{t-1} \end{aligned}$$

Thus

$$\begin{aligned} QO_t &= TIS_t * \sum_{j=1}^N Y_j - TOS_t * \sum_{j=1}^N Z_j + R * QO_t \\ QI_t &= TIS_t * \sum_{j=1}^N X_j - TOS_t * \sum_{j=1}^N Y_j + R * QI_t \end{aligned}$$

In order to satisfy these two equations simultaneously, it is necessary that

$$\sum_{j=1}^N X_j = \sum_{j=1}^N Y_j = \sum_{j=1}^N Z_j = U^*(1 - R)$$

In fact, the conduction transfer functions of the sample wall shown in Table A-10 can be shown to satisfy this requirement

$$\sum X_j = \sum Y_j = \sum Z_j = 0.0668$$

and

$$U^*(1 - R) = 0.418^*(1 - 0.8398) = 0.0669$$

## HEATW

### An Algorithm for Calculating Transient Heat Conduction Through Opaque Walls or Roofs Using Conduction Transfer Functions

Data:

$X_j$ ,  $Y_j$  and  $Z_j$  for  $j = 0, 1, 2, \dots, N$ : Conduction transfer functions in Btu per (hr) (sq ft), (Calculated as outlined in XYZ for the system that excludes the inside and outside heat resistance layers)

R: Common ratio of the response factors  $X'$ ,  $Y'$  and  $Z'$ \*  
(Calculated as outlined in XYZ),

$$R = \frac{X'_{j+1}}{X'_j} = \frac{Y'_{j+1}}{Y'_j} = \frac{Z'_{j+1}}{Z'_j} \text{ for } j \geq N$$

N: Number of the significant terms to be used for the conduction heat transfer calculation, (Calculated as outlined in XYZ)

$FO_t$ : Outside surface heat transfer coefficient at time  $t$ , Btu per (hr) (sq ft) (F)

$IT_t$ : Total solar radiation intensity on the outside surface at time  $t$ , Btu per (hr) (sq ft), (Calculated in SOLAD)

---

\*  $X_j = X'_j - R * X'_{j-1}$

$$Y_j = Y'_j - R * Y'_{j-1}$$

$$Z_j = Z'_j - R * Z'_{j-1}$$

- TIS<sub>t-j</sub>: History of inside surface temperature at times t-1, t-2, ... and (t-N)th hour, F
- TOS<sub>t-j</sub>: History of outside surface temperature at times t-1, t-2, t-3, ... and (t-N)th hour, F
- DB<sub>t</sub>: Outdoor air dry-bulb temperature at time t, F
- HEAT<sub>t-1</sub>: Heat loss at the interior surface to the outdoor environment at the previous hour, Btu per (hr) (sq ft)
- QO<sub>t-1</sub>: Heat loss at the exterior surface to the outdoor environment at the previous hour, Btu per (hr) (sq ft)
- a: Solar absorption coefficient at the exterior surface
- α: Cosine of the angle subtended by a vertical line and the surface normal ... (Calculated in SUN)
- TC<sub>t</sub>: Total cloud amount ... (Calculated in CLIMATE)
- TM: A reference temperature (usually the inside design temperature), F

Calculation Sequence:

A. Exterior walls and roof

1. The heat balance equation at the exterior surface is given by

$$QR_t + QA_t + QO_t - QS_t = 0$$

where

- a) Incident solar radiation

$$QR_t = a * IT_t$$

- b) Convection heat transfer from the outdoor air

$$QA_t = FO_t * (DB_t - TOS_t)$$

c) Conduction heat flow from the inside surface

$$QO_t = \sum_{j=0}^N Y_j * (TIS_{t-j} - TM) - \sum_{j=0}^N Z_j * (TOS_{t-j} - TM) + R * QO_{t-1}$$

d) Heat loss to the sky

$$QS_t = 2 * Q_0 * (10 - TC_t)**$$

2. Let

$$SUM1 = \sum_{j=0}^N Y_j * (TIS_{t-j} - TM) + CR * QO_{t-1}$$

$$SUM2 = \sum_{j=1}^N Z_j * (TOS_{t-j} - TM)$$

3. Outside surface temperature

$$TOS_t = (QR_t - QS_t + FO_t * DB_t + SUM1 - SUM2 + Z_0 * TM) / (FO_t + Z_0)$$

4. Using this new  $TOS_t$ , the heat loss at the interior surface is then determined as follows:

$$HEAT_t = \sum_{j=0}^N X_j * (TIS_{t-j} - TM) - \sum_{j=0}^N Y_j * (TOS_{t-j} - TM) + R * HEAT_{t-1}$$

---

\* Throughout this discussion a value of TM is always subtracted from the interior surface and exterior surface temperatures. This subtraction usually helps to minimize the digital errors which occur and are sometimes significant when a large number of numerical data are multiplied and added. Since  $\sum_{j=0}^N X_j = \sum_{j=0}^N Y_j$ , the net effect of the subtraction is zero.

\*\* This expression was developed to yield a roof sky radiation of 20 Btu per (hr) (sq ft) for a cloudless condition, which was reported in Reference (12).



### INSULATED ROOF (SUMMER)

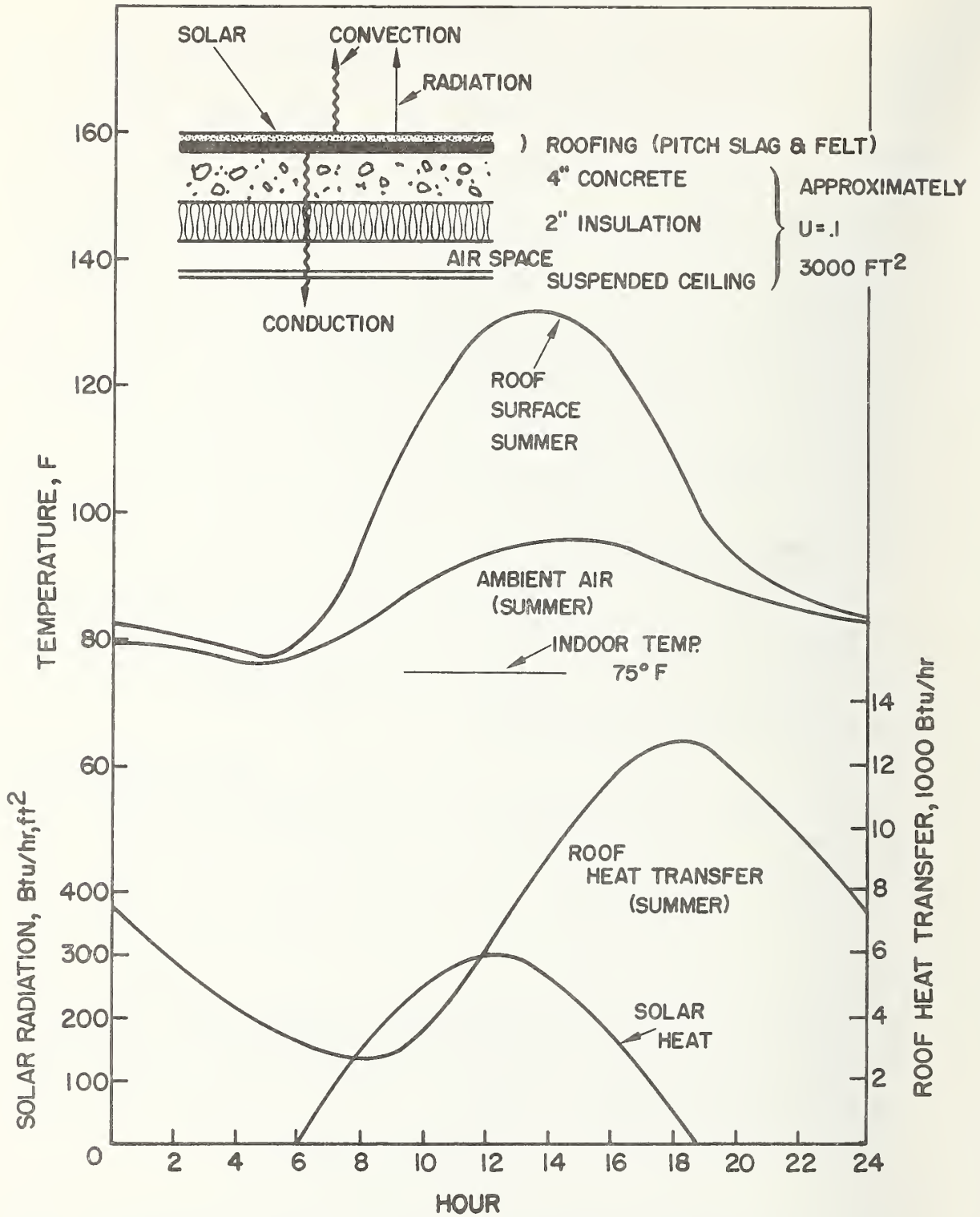

Figure A-17 Transient Heat Transfer in a Typical Roof

Table A-11

Layer No.	L(I)	K(I)	$\rho$ (I)	C(I)	RES(I)	Description of Layers
1	0.	0.	0.	0.	2.04	Suspended Ceiling
2	.167	.025	13.	.320	0.	2-in. Insulation
3	.333	1.000	140.	.200	0.	4-in. Concrete
4	.031	.110	70.	.400	0.	3/4-in. Felt
5	.042	.830	55.	.400	0.	1/2-in. Pitch Slag

Time Increment DT = 1.

#### Conduction Transfer Functions

j	$X_j$	$Y_j$	$Z_j$	R
0	.21934	.00011	3.30513	.78793
1	-.25485	.00504	-4.27082	
2	.04650	.01060	.97885	
3	.00857	.00493	.00808	
4	.00224	.00140	.00104	
5	.00059	.00037	.00024	
6	.00016	.00010	.00006	
7	.00004	.00003	.00002	
8	.00001	.00001	.00000	
9	.00000	.00000	.00000	

Figure A-17 shows the energy balance that is involved in the above calculation sequence and the results of a typical calculation. Table A-11 gives the conduction transfer functions for the roof used in the calculations.

#### B. Interior walls and floor/ceiling sandwich

The calculation sequence for the partition wall and floor/ceiling sandwich is completely different from that of the exterior wall or roof. The difference is due to the fact that the air temperature at the exterior side of the construction can be assumed the same as at the interior side, at least for a climate controlled building. In order to take advantage of this fact, conduction transfer functions should be determined with the surface thermal resistance layer added at the exterior side of the structure. The heat loss through a partition wall is then calculated by

$$\text{HEAT}_t = \sum_{j=0}^N X_j * (\text{TI}_{t-j} - \text{TM}) - \sum_{j=0}^N Y_j * (\text{TA}_{t-j} - \text{TM}) + R * \text{HEAT}_{t-1}$$

where  $\text{TA}_{t-j}$  = room temperature at time (t-j)th hour

If the room temperature were maintained constant at TM, which is usually the case, the terms involving the  $Y_j$ 's would then drop out of the equation.

#### C. Slab on grade floor

The heat loss to the ground through the floor on grade can be calculated by using conduction transfer functions determined on the basis of flooring, concrete, and 12 inches of ground layer

$$\text{HEAT}_t = \sum_{j=0}^N X_j * (\text{TI}_{t-j} - \text{TM}) - \sum_{j=0}^N Y_j * (\text{TG} - \text{TM}) + R * \text{HEAT}_{t-1}$$

Since usually TG is constant and

$$\sum_{j=0}^N Y_j = U_G * (1 - R),$$

then

$$\text{HEAT}_t = \sum_{j=0}^N X_j * (\text{TI}_{t-j} - \text{TM}) - U_G * (1 - R) * (\text{TG} - \text{TM}) + R * \text{HEAT}_{t-1}$$

The same method is applicable to a floor with a crawl space as long as the space is not vented. The conduction transfer functions for the floor with an unvented crawl space simply has an additional air resistance layer to account for the dead air space between the floor and the ground. In many cases it is safe to assume that  $\text{TG} = \text{TM}$ , and then the term involving  $U_G$  would drop out of the equation.

#### D. Floor over the vented crawl space

The floor over a vented crawl space can be treated in the same manner as an exterior wall or roof except that the solar radiation and sky radiation terms would not be included in the energy balance and that the outside surface heat transfer coefficient is replaced by a value similar in magnitude to the inside surface heat transfer coefficient. If the conduction transfer functions include the outside surface heat transfer resistance, the calculation is simply

$$\text{HEAT}_t = \sum_{j=0}^N X_j * (\text{TI}_{t-j} - \text{TM}) - \sum_{j=0}^N Y_j * (\text{DB}_{t-j} - \text{TM}) + R * \text{HEAT}_{t-1}$$

## SCHEDULE

### An Algorithm to Determine Heat Gains From Lighting, Equipment, Occupancy and Ventilation

#### Data:

1. Normalized 24 hour profiles ( $j = 1, 2, 3 \dots 24$ ) of operational schedules for weekdays ( $i = 1$ ) and weekends and holidays ( $i = 2$ ) are given for lighting, equipment use, occupancy, ventilation, indoor temperature setting, and humidity setting as follows:

QLITE <sub>$i,j$</sub> : Lighting schedules (fraction of some maximum)

QEQUP <sub>$i,j$</sub> : Equipment use schedules (fraction of some maximum)

QOCUP <sub>$i,j$</sub> : Occupancy schedule (fraction of some maximum)

QVENT <sub>$i,j$</sub> : Ventilation fan operating schedule (fraction of some maximum)

ROOMDB <sub>$i,j$</sub> : Space thermostat setting schedule

ROOMRH <sub>$i,j$</sub> : Space humidistat setting schedule

2. Maximum values of the parameters to be used with the schedules

QLITX: Maximum electric power demand for lighting for the 24 hour period

QEQUPX: Maximum electric power demand for appliances for the 24 hour period, KW

QOCUPX: Maximum number of equivalent sedentary adult occupants during the 24 hour period

QVENTX: Maximum amount of ventilation air supply during the 24 hour period, cu. ft per min.

QHIWTX: Maximum amount of hot water demand during the 24 hour period, gallons per hour

3. YEAR, MONTH AND DAY

These data are needed to determine whether the day is a week-day, weekend, or holiday, and whether the day falls within daylight savings time.

4. QOS(TA): Sensible heat loss of a sedentary adult at the room temperature TA, Btu per (hr) (occupant)

QOL(TA): Latent heat loss of a sedentary adult at the room temperature TA, Btu per (hr) (occupant)

WO(DB,WB): Humidity ratio of the outdoor air for a given outdoor air dry-bulb and wet-bulb temperature, lb of water vapor per (lb of dry air)

WI(TA,WGA): Humidity ratio of the indoor air for a given dry-bulb temperature and wet-bulb temperature, lb of water vapor per (lb of dry air)



QWT: Heat needed to generate one gallon of hot  
water, Btu per gallon of water

Calculation Sequence:

1. Determine the weekday indicator IWK from WKDAY
2. Determine the holiday indicator IHOL from HOLIDAY
3. If IWK = 1 or 7  $i = 2$   
If IHOL = 1  $i = 2$   
Otherwise  $i = 1$
4. Heat generated from lights (for  $j = 1 \dots 24$ ), Btu per hr

$$QS_{i,j} = QLITX * 3413 * QLITE_{i,j}$$

5. Heat generated from equipment and occupants, Btu per hr  
(for  $j = 1, 2 \dots 24$ )

Sensible heat

$$QS_{i,j}' = QEQUX * 3413 * QEQU_{i,j} + QOCUPX * QOS(TA) * QOCUP_{i,j}$$

Latent heat

$$QL_{i,j} = QOCUPX * QOL(TA) * QOCUP_{i,j}^*$$

6. Heat gain due to ventilation air, Btu per hr

Sensible heat

$$LEAK_{i,j} = QVENTX * C_p * 60 * (DB_j - ROOMDB_{i,j}) * QVENT_{i,j} * \rho$$

Latent heat

Determine  $WI_j$  from PSY using  $ROOMDB_{i,j}$  and  $ROOMRH_{i,j}$

$$LEAK_{i,j}' = QVENTX * 60 * (WO_j - WI_j) * 1060 * QVENT_{i,j} * \rho$$

$C_p$  and  $\rho$  on this page depict specific heat and density of  
air in the English units.

---

\* It has been assumed that there is no latent portion of the equipment heat gain. There can be exceptions to this.

Fundamentals of Room Temperature and Cooling  
(Heating) Load Calculations

The basic energy transfer process that occurs in a room can best be illustrated by an electrical circuit network as shown in Figure A-18. The figure represents the phenomenon in a typical room having two exterior walls, each of which contains a window, and two interior partition walls, in addition to the roof and floor (see Figure A-19). Heat conduction paths through the walls, roof, and floor are depicted by resistance and capacitance circuits and these through windows are represented by resistance circuits, implying that the windows do not have significant thermal mass. Points  $T_{S1}$  through  $T_{S8}$  in Figure A-18 indicate interior surfaces of the walls, roof, floor and windows, all of which receive conduction heat through solid material, solar radiation (represented by  $\leftarrow q$ ) through transparent surface and long wavelength radiation from other solid surfaces indicated by solid lines connecting the surface nodes; and they lose heat to the room air (represented by a point called TA) by the convection process (dashed lines).

At the top of Figure A-18, the radiation heat exchange between the room surfaces, the surfaces of lighting fixtures, equipment such as business machines, and occupants is depicted. Also indicated in this same location is the convective heat exchange between these items and the room air. Actual heat or power input to these internal heat sources are indicated by  $\leftarrow Q$ . Although not indicated in this figure, it is possible to represent the conduction heat gain from the inner core of lighting fixtures and equipment if they have sufficient thermal mass. This equipment could of course include the unit heaters or air conditioners

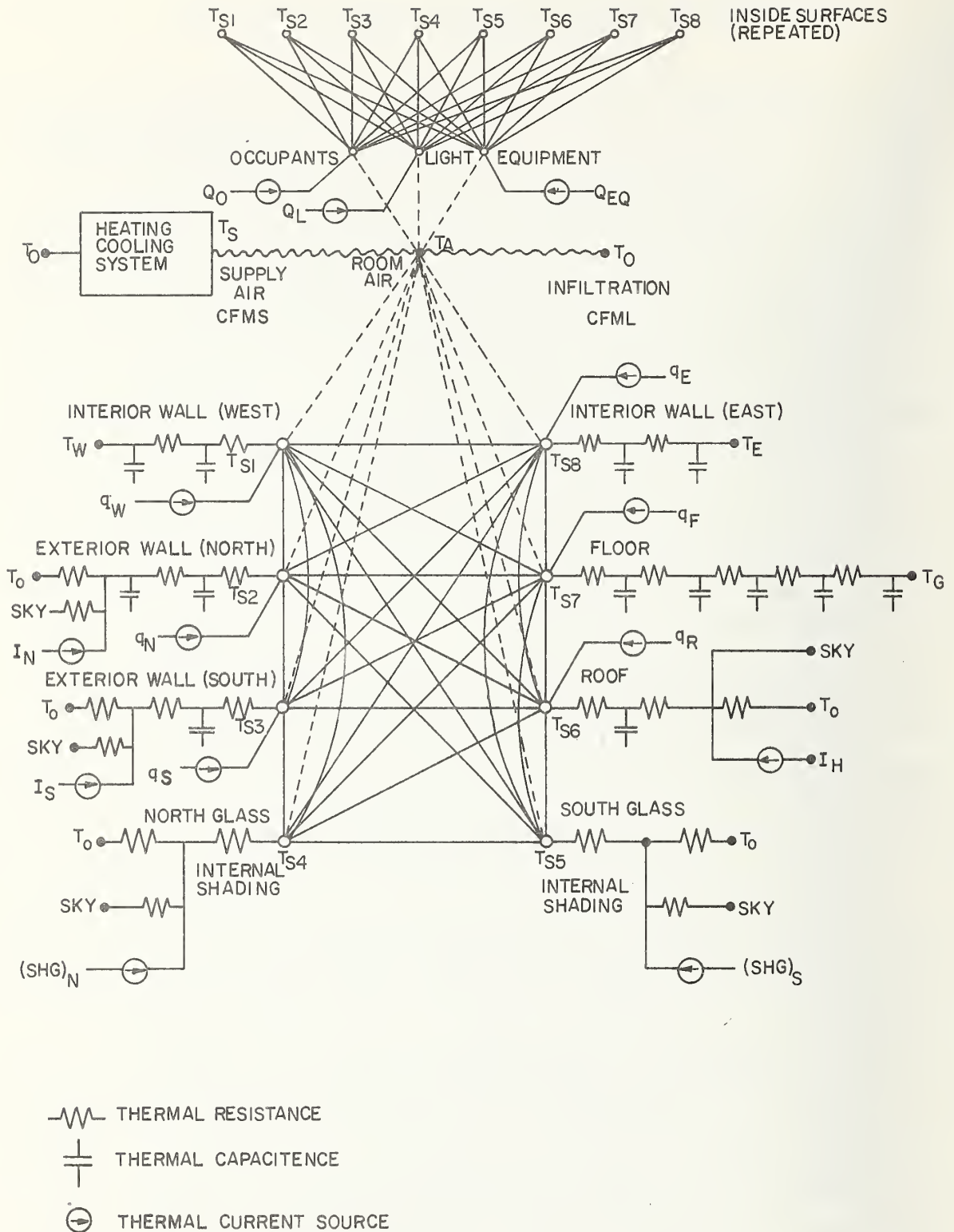

Figure A-18 Analogous Electric Circuit for Heat Exchange Process in a Room

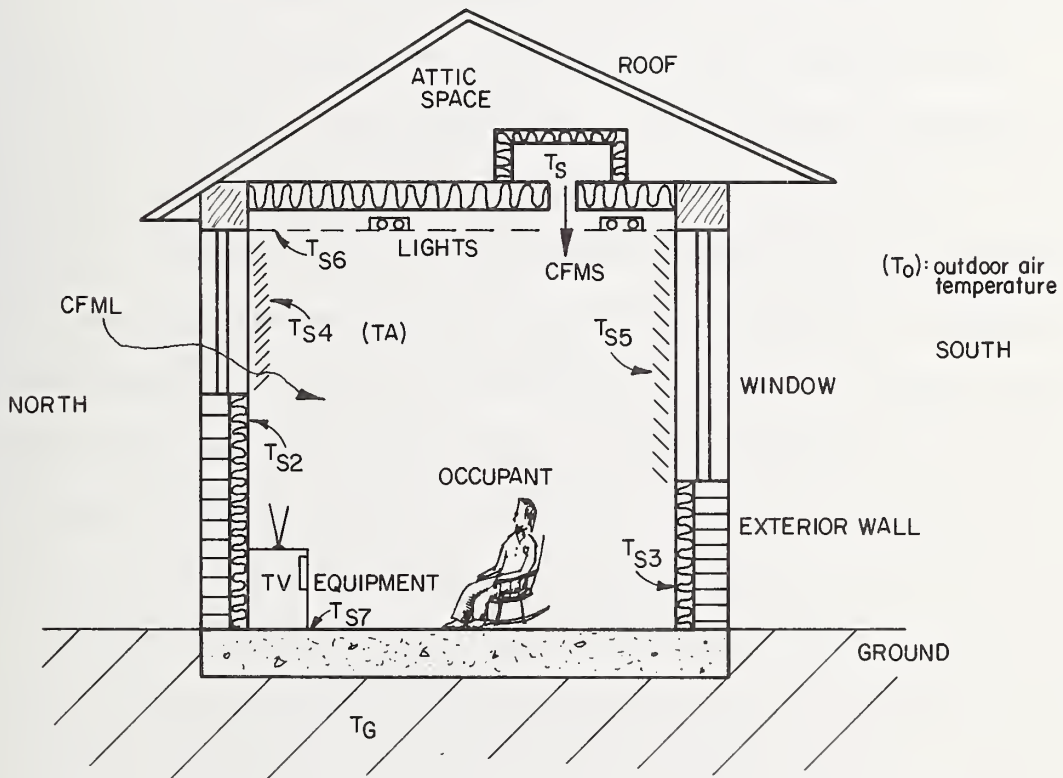
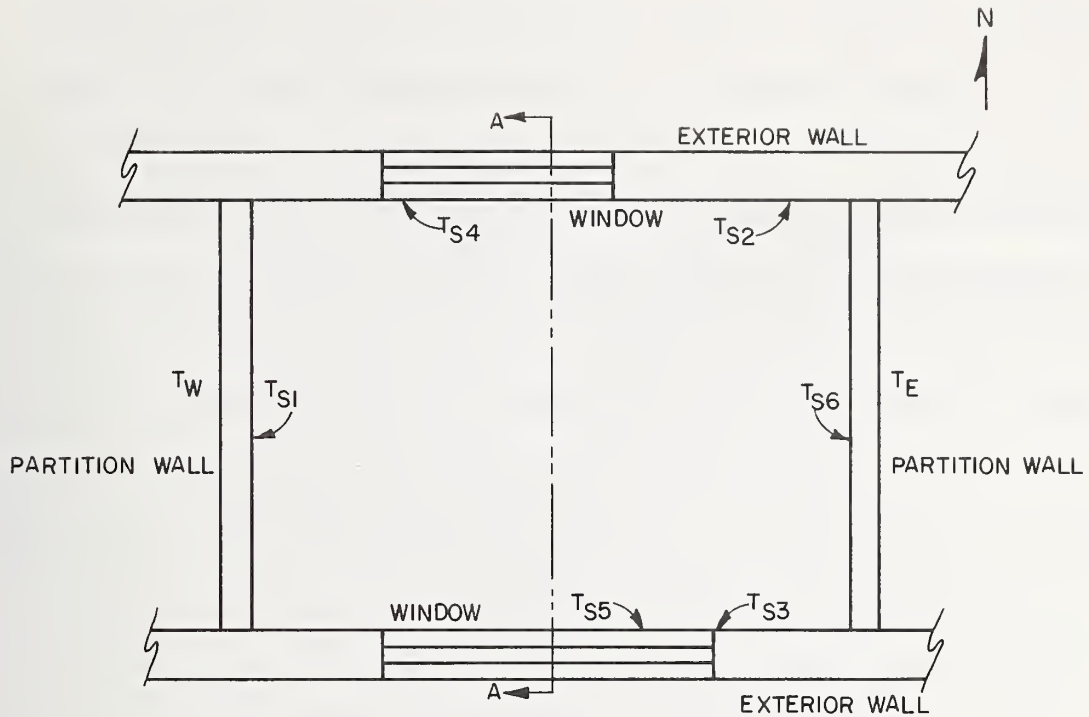

Figure A-19 Physical Model of a Typical Room Used in Figure A-18

if they are the part of the room heat exchange system. The room air changes energy with outdoor air or with the conditioned air from the central climate control system (or the forced ventilation system) and is depicted in this figure by lines  $\overline{T_s T_a}$  and  $\overline{T_o T_a}$ . The heat exchange at the exterior surfaces with outdoor air, sky and sun (except for the partition walls and floor on grade) are also indicated using a normal design calculation procedure, the temperature or heat flow at the exterior sides of the room surfaces are usually available either by calculation or as input data. The exception occurs when two or more rooms adjacent one another are treated simultaneously. This latter case is commonly referred to as a "multi-room problem" and is very complex. No satisfactory solution for this case is presently available.

This electrical network problem can be solved and the corresponding calculation algorithm is called RMTMP (given in the following section). The solution can be obtained in two different modes: room temperature calculation mode or the room load calculation mode. The room temperature calculation mode requires the simultaneous solution of heat balance equations in order to determine all the surface temperatures together with the air temperature. On the other hand, the room cooling load calculation mode requires that the room temperature be prescribed and only the room surface temperatures are solved for. The convective heat exchange between the room air and the heat emitting surfaces is then the cooling load (or the heating load if the heat is lost to the surfaces). These two modes of computation can be combined to simulate the actual thermal behavior of a room and its environment where the temperature fluctuates. The floating temperature would be calculated



as long as it remained between prescribed limits. A heating load would be computed when the room temperature fell to the lower limit and a cooling load would be calculated when the temperature rose to the upper limit. In this manner, the calculation of load and subsequent energy requirement would more closely correspond to actual building and system operation.



## RMIMP

### An Algorithm to Calculate Thermal Load or Room Temperature

This routine calculates heating and cooling loads or room temperature by solving heat balance equations involving each of the room surfaces. A room surface receives conduction heat flow through the solid wall, roof or floor material from behind, convection heat flow from the air and radiation heat flow from other surfaces and internal heat sources such as occupants, equipment and lighting fixtures.

#### Data:

NS: Total number of heat transfer surfaces contributing to the room heat balance

$S_i$ : Area of i-th heat transfer surface, sq ft, where  
 $i = 1, 2, 3, \dots NS$

$X_{i,j}$ ,  $Y_{i,j}$  and  $Z_{i,j}$ :

Where  $i = 1, 2, 3, \dots NS$

$j = 1, 2, \dots N_i$

Conduction transfer functions of i-th surface in Btu per (hr) (sq ft) ... (Calculated in XYZ).

These conduction transfer functions are usually evaluated without the interior or room side surface thermal resistance. The thermal resistance layer of exterior surface is also omitted if the exterior surface temperature is to be computed as a result of a heat balance involving solar radia-

tion, sky radiation and convective loss to the outdoor air.

$N_i$ : Number of conduction transfer function terms to be used for the calculation of the  $i$ -th surface conduction heat gain

$R_i$ : Common ratio for the conduction transfer function of the  $i$ -th surface

$TOS_{i,t-j}^*$ : for  $i = 1, 2, 3, \dots NS$  and  $j = 0, 1, 2, \dots N_i$   
Outside surface temperature history from present hour to that of  $N_i$  hours ago for  $i$ -th surface, F.  
(This information is available from HEATW routine.)

$TIS_{i,t-j}$ : for  $i = 1, 2, 3, \dots NS$  and  $j = 1, 2, 3, \dots N_i$   
Inside surface temperature history from one hour ago to  $N_i$  hours ago for  $i$ -th surface, F. The present value (for  $j = 0$ ) will be computed in this routine and stored for future use.

$TA_t$ : Air temperature of the room at time  $t$ , F

$DB_t$ : Outdoor air temperature at time  $t$ , F

$TS_t$ : Supply air temperature from the central system at time  $t$ , F

$H_i$ : Inside surface convection heat transfer coefficient for  $i$ -th surface, Btu per (hr) (sq ft) (F)

---

\* Subscript  $t$  refers to the present time  $t$  and  $t-j$  refers to the present time minus  $j$  hours.

$F_{i,k}$ : Radiation heat exchange view factor between the i-th surface and k-th surface

$$F_{i,k} = F_{k,k} = 0$$

$E_i$ : Emissivity of the i-th surface

$R_{i,t}$ : Radiant heat flux impinging upon i-th surface at time t from various sources, which include solar radiation, radiation from lights, occupants and equipment, Btu per (hr) (sq ft)

$Q_{i,t}$ : Heat conducted into i-th surface at time t, Btu per (hr) (sq ft)

$GL_t$ : Mass air flow rate due to air leakage at time t, lb per hr

$GS_t$ : Mass air flow rate of the supply air from the central system at time t, lb per hr

QEQUP: Internal heat generated from equipment such as business machines and computers, Btu per hr

QOCPs: Internal heat (sensible) generated from occupants (a function of room air temperature), Btu per hr

QLITE: Heat from lights, Btu per hr

RE: Fraction of internal heat gain from equipment that can be assumed to be convective

RO: Fraction of internal heat gain from occupants that can be assumed to be convective

RL: Fraction of heat gain from lights that can be assumed to be convective

SHG<sub>i,t</sub>: Solar incident radiation on i-th surface at time t,  
 Btu per (hr) (sq ft)

Calculation Sequence:

1. Heat balance equation at the i-th surface at time t

$$Q_{i,t} = \sum_{j=0}^{N_i} X_{i,j} * TIS_{i,t-j} - \sum_{j=0}^{N_i} Y_{i,j} * TOS_{i,t-j} + R_i * Q_{i,t-1}$$

$$= H_i * (TA_t - TIS_{i,t}) + \sum_{k=1}^{NS} G_{i,k} * (TIS_{k,t} - TIS_{i,t}) + R_{i,t}$$

where  $G_{i,k} = 4 * E_i * F_{i,k} * (TA_t + 460) ** 3 * 0.1714 * 10 ** -8$

$$R_{i,t} = SHG_{i,t} + \frac{((1-RE)*QEQUP + (1-RO)*QOCPS + (1-RL)*QLITE)}{\sum_{i=1}^N S_i}$$

2. Heat balance for the room air

$$\sum_{i=1}^{N_s} S_i * (TIS_{i,t} - TA_t) + GL_t * C_p * (DB - TA_t) + GS_t * C_p *$$

$$(TS_t - TA_t) + QEQUP * RE + QOCPS * RO + QLITE * RL = 0$$

where C<sub>p</sub> is the specific heat of air in Btu per (lb) (F)

The values of GS<sub>t</sub> and TS<sub>t</sub>, supply air flow rate and its temperature, are the link between the load calculation and the system simulation. (More detailed explanation of this aspect is given in the final portion of this section.)

3. Assigning matrix elements for  $i = 1, 2, 3, \dots, NS$  and for  $k = 1, 2, 3, \dots, NS$

$$A_{i,i} = X_{i,1} + H_i + \sum_{k=1}^{NS} G_{i,k}$$

$$A_{i,k} = -G_{i,k} = A_{k,i} = -G_{k,i}$$

$$A_{i,NS+1} = -H_i$$

$$B_i = -\sum_{j=1}^{N_i} X_{i,j} * TIS_{i,t-j} + \sum_{j=0}^{N_i} Y_{i,j} * TOS_{i,t-j} - R * Q_{i,t-1} + R_{i,t}$$

$$A_{NS+1,k} = S_k * H_k$$

$$A_{NS+1,NS+1} = -(GL_t + GS_t) * C_p - \sum_{k=1}^{NS} H_k * S_k$$

$$B_{NS+1} = -QEQU*RE + -QOCPS*RO - QLITE*RL - GL_t*C_p*DB_t - GS_t*C_p*TS_t$$

4. Using these matrix elements, the following  $NS+1$  equation should be solved simultaneously for  $TIS_{i,t}$  ( $i = 1, 2, \dots, NS$ ) and for  $TA_t$

$$\begin{bmatrix} A_{1,1} & A_{1,2} & A_{1,NS+1} \\ A_{2,1} & A_{2,2} & A_{2,NS+1} \\ \dots & \dots & \dots \\ A_{NS,1} & A_{NS,2} & A_{NS,NS+1} \\ A_{NS+1,1} & A_{NS+1,2} & A_{NS+1,NS+1} \end{bmatrix} * \begin{bmatrix} TIS_{1,t} \\ TIS_{2,t} \\ \dots \\ TIS_{NS,t} \\ TA_t \end{bmatrix} = \begin{bmatrix} B_1 \\ B_2 \\ \dots \\ B_{NS} \\ B_{NS+1} \end{bmatrix} *$$

5. When the value of  $TA_t$  has been specified, as in the case of a controlled condition, the following NS equations should be solved instead of the NS+1 equations given above

$$\begin{bmatrix} A_{1,1} & A_{1,2} & \dots & A_{1,NS} \\ A_{2,1} & A_{2,2} & & A_{2,NS} \\ \dots & \dots & & \dots \\ A_{NS,1} & A_{NS,2} & & A_{NS,NS} \end{bmatrix} * \begin{bmatrix} TIS_{1,t} \\ TIS_{2,t} \\ \dots \\ TIS_{NS,t} \end{bmatrix} = \begin{bmatrix} B'_1 \\ B'_2 \\ \dots \\ B'_{NS} \end{bmatrix} *$$

where

$$B'_i = B_i - A_{i,NS+1} * TA_t$$

\* Remark: The matrix type solution is not required if it is assumed that

$$\sum_{k=1}^{NS} G_{i,k} * (TIS_{k,t} - TIS_{i,t}) = HR * (TA_t - TIS_{i,t})$$

or

$$A_{i,k} = 0 \text{ when } i \neq k$$



6. Calculate the sensible load by

$$QLS_t = \sum_{i=1}^{N_s} S_i * (TIS_{i,t} - TA_t) + GL_t * C_p * (DB_t - TA_t) \\ + QEQU * RE + QOCPS * RO + QLITE * RL$$

In this expression, QL is a cooling load if positive and it is a heating load if negative. This is the heat picked up by the room air (or that lost by the room air) which has to be removed (or added) by the central air conditioning system.

Note that for ordinary load calculations,  $GS_t$  and  $TS_t$  are not used as long as the following condition is satisfied:

$$|QLS_t| \leq |GS_t * C_p * (TA_t - TS_t)| \dots \text{Maximum capacity} \\ \text{of the heating or cooling system}$$

In other words, the desired or prescribed room temperature can be maintained as long as the calculated load is less than the maximum capacity of the central system. When the above condition is not satisfied because of the inadequate values for either the air supply rate or the supply air temperature, the room temperature used for the load calculation is no longer valid. The calculation must then be revised, first calculating the room temperature as outlined in 3 above.

## 7. Latent Load

If moisture condensation and absorption by room walls, or drying of the wall panels can be neglected, the latent load is the same as the latent heat gain or loss, provided the following condition is met:

$$QLL_t \leq GS_t * \lambda * (WA - WS), \text{ where } \lambda = \text{latent heat} \\ \text{of vaporization } \approx 1061 \text{ Btu per lb of water}$$

In other words, the desired moisture level can be maintained as long as the latent load of the room or the building is less than the capacity of the central system to remove (add) water vapor. When the above condition is not satisfied because of the inadequate air flow rate of the air supply system or the value of WS, the room humidity ratio would change according to

$$WI = \frac{GS_t * WS + GL_t * WA + QLL/\lambda}{GS_t + GL_t}$$

This equation becomes indeterminate when there is no air supply or air leakage to or from the room. Theoretically the room relative humidity would reach 100% soon after the air supply or air leakage is stopped provided normal internal sources were still present. Under those conditions, seasonal value of WI to be used would be that corresponding to the dew point temperature which would be approximately equal to the average

wall surface temperature of the space.

The most important application of RMTMP is for taking into account some of the performance characteristics of the room's (or space's) heating and cooling systems where the evaluation of heating and cooling load is linked to the system capacity. Presented in this section is a sample algorithm to illustrate how RMTMP can be used to account for the type of occupancy, temperature control scheme, and the system capacity. In this illustration, the heating/cooling load will be set equal to the maximum capacity of the system when the calculated load at a given time is greater than the maximum system capacity. The space or room temperature is then calculated on the basis of net load, which is the difference between the calculated load at a given design temperature and the maximum system capacity. If, on the other hand, the space temperature falls within the prescribed upper and the lower limits, the load is set equal to zero. The same procedure is applied to the latent load calculation. The details of the algorithm is depicted in the flow diagram (Figure A-20). The nomenclature for the figure is given in Table A-12.

RELATIONSHIP BETWEEN  
TA, TLL, TUL, QLS, QCLDS, QHLDL

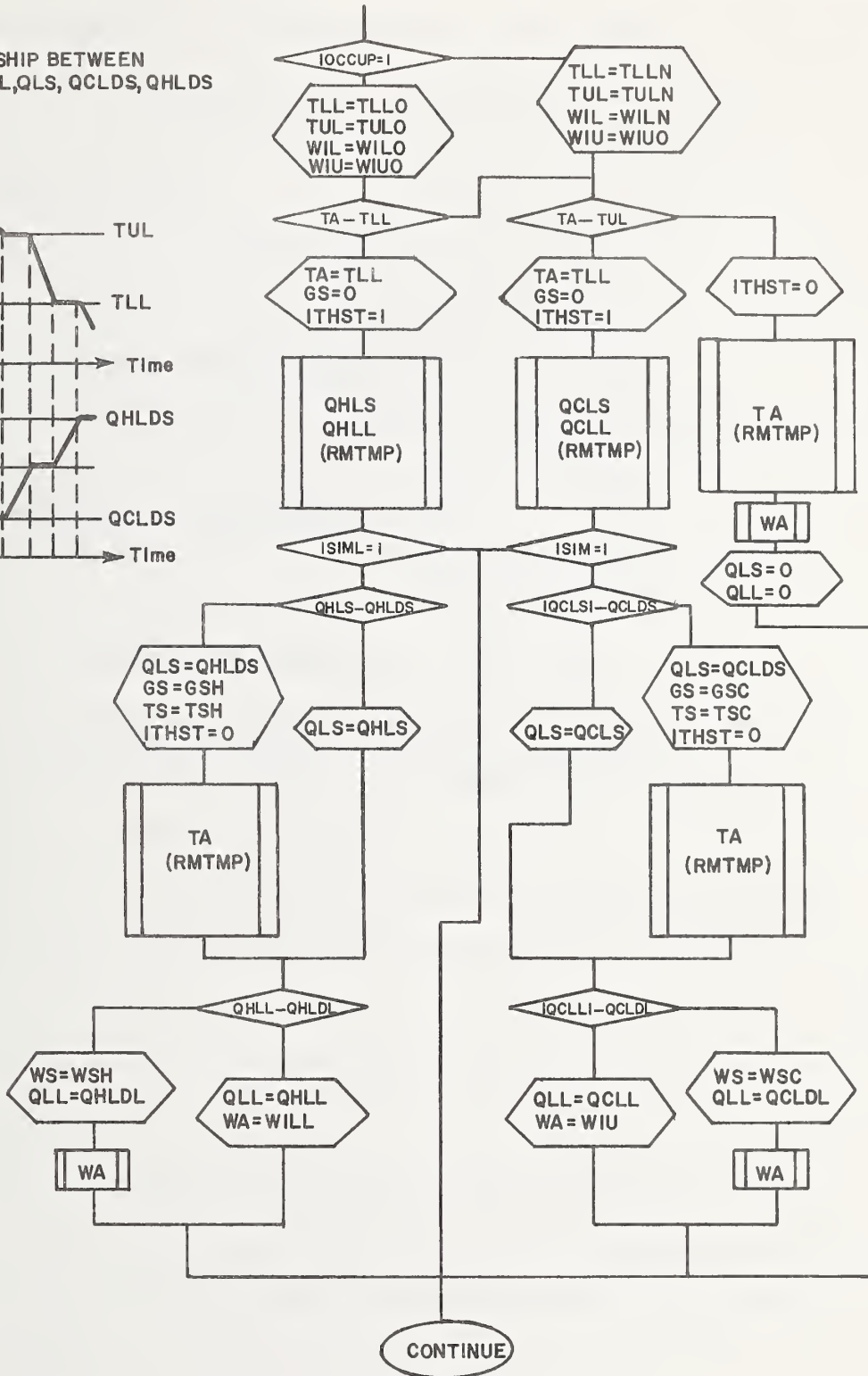
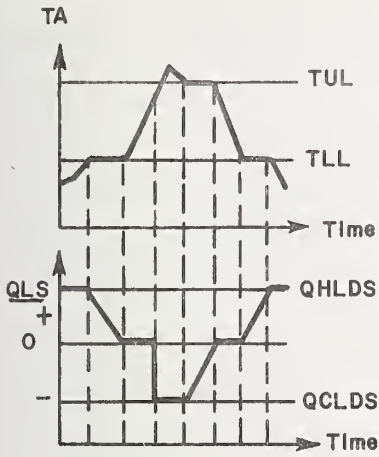

Figure A-20 Flow Diagram of the Room Temperature and the Room Thermal Load Calculation Steps

Symbols used in the flow diagram, Figure A-20



Setting of the variables



Calculation by RMTMP



Calculation of WA



Testing of "yes" or "no"

Table A-12

Nomenclature for Figure A-20

**IOCCUP:** Occupancy index

1 if during the occupied period

0 if during the unoccupied period

**ISIML:** System capacity consideration index

1 if the calculated load is to be compared with the maximum capacity of the system

0 if the load is to be estimated without regard to the installed system capacity

**ITHST:** Room temperature control index

1 if a space temperature is prescribed at a given level and the heating and cooling load is to be calculated to meet this prescribed condition

0 if the space temperature is to be determined as a balance between the required load and the available capacity of the system

**TLL:** The lower limit of temperature, below which heating must be supplied

**TLL0:** The lower limit of temperature during the occupied period

**TLLN:** The lower limit of temperature during the unoccupied period

**TUL:** The upper limit of temperature, above which cooling must be provided



TULO: The upper limit of temperature during the occupied period

TULN: The upper limit of temperature during the unoccupied period

WIL: The lower limit of humidity ratio, below which the room requires humidification

WILO: The lower limit of humidity ratio during the occupied period

WILN: The lower limit of humidity ratio during the unoccupied period

WIU: The upper limit of humidity ratio, above which the room requires dehumidification

WIUO: The upper limit of humidity ratio during the occupied period

WIUN: The upper limit of humidity ratio during the unoccupied period

GS: Mass flow rate of air from the supply system

GSH: Maximum mass flow rate of air from the supply system during heating

GSC: Maximum mass flow rate of air from the supply system during cooling

TS: Air temperature of the supply air system

TSH: Maximum temperature of air from the supply system during heating

TSC: Minimum temperature of air from the supply system during cooling

WS: Humidity ratio of the air from the supply system

WSH: Maximum humidity ratio of air from the supply system during a period when heating and humidification occur

WSC: Minimum humidity ratio of air from the supply system during a period when cooling and dehumidification occur

$C_p$ : Specific heat of air

$\lambda$ : Latent heat of vaporization

QHLDS: Maximum system capacity for heating, Btu per hr

$$QHLDS = GSH * C_p * (TSH - TA)$$

QHLDL: Maximum system capacity for humidification

$$QHLDL = GSH * \lambda * (WSH - WA)$$

QCLDS: Maximum system capacity for cooling, Btu per hr

$$QCLDS = GSC * C_p * (TA - TSC)$$

QCLDL: Maximum system capacity for dehumidification

$$QCLDL = GSC * \lambda * (WA - WSC)$$

The primary variables that are determined by this mode of calculation are:

QHLS: Sensible heating load of the space

QHLL: Latent heating load of the space

QCLS: Sensible cooling load of the space

QCLL: Latent cooling load of the space

TA: Space temperature

WA: Space humidity ratio

## ATTIC

### A Description of the Load Calculation for an Attic Space

In many cases the heating and cooling load in an attic space is affected strongly by the manner in which the attic conditions are maintained. The non-ventilated attic space may be treated as a simple air space within a roof structure and accounted for in the calculation of the conduction transfer functions. Where the attic space is ventilated during the summer to take advantage of the resulting natural cooling effect of the outdoor air, it has to be treated somewhat differently. Since it is reasonable to assume that the radiation heat exchange between the underside of the roof surface and the attic is as significant as the ventilation air rate in determining the attic thermal condition, RMTMP should be used. No additional algorithms are then required since all aspects covered in RMTMP apply directly to the attic heat transfer calculation. Of course, the solar radiation through windows, and internal heat gain from lighting and occupants would most likely be omitted. The floor should be treated as having its exterior surface exposed to the environmental conditions of the room below. The heat loss at the "exterior" surface of the floor then becomes the heat gain to the room beneath the ceiling.

FIJ 1 outlines the calculation procedure for obtaining the necessary shape factors where the attic has a gabled roof.

## IHG

### An Algorithm to Calculate Instantaneous Heat Gain of a Space at Time $t$

#### Data:

##### Windows:

- NY: Number of windows
- AY<sub>k</sub>: Area of each window, sq ft
- UY<sub>k</sub>: Overall heat transfer coefficient for each  
window, Btu per (hr) (sq ft) (f)
- SHG<sub>k</sub>: Solar heat gain through each window, Btu per  
(hr) (sq ft) (Calculated in SHG)

##### Exterior Walls and Roofs:

- NX: Number of exterior walls and roofs
- AX<sub>k</sub>: Area of each exterior wall and roof, sq ft
- HEAT<sub>k</sub>: Heat gain through each exterior wall and roof,  
Btu per (hr) (sq ft) (Calculated in HEATW)  
where  $k = 1, 2, \dots NX$

##### Lights:

- NS: Number of different types of lights
- QS<sub>k</sub>: Power input to each type of light, Btu per hr  
where  $k = 1, 2, \dots NS$

Internal Heat Source Other than Lights:

NS': Number of different types of internal sensible heat sources other than lights

QS'<sub>k</sub>: Heat generation from each internal sensible heat source, where  $k = 1, 2, \dots, NS'$

NL: Number of different types of internal latent heat sources

QL'<sub>k</sub>: Latent heat gain from each internal latent heat source, Btu per hr, where  $k = 1, 2, \dots, NL$

Inside Doors:

ND: Number of inside doors

AD'<sub>k</sub>: Area of each inside door, sq ft

UD'<sub>k</sub>: Overall heat transfer coefficient of each inside door, where  $k = 1, 2, \dots, ND'$

Outside Doors:

ND': Number of outside doors

AD'<sub>k</sub>: Area of each outside door, sq ft

UD'<sub>k</sub>: Overall heat transfer coefficient of each outside door, Btu per (hr) (sq ft) (F), where  $k = 1, 2, \dots, ND'$

Partitions:

- NP: Number of partitions which separate the space from other spaces at different temperatures
- $AP_k$ : Area of each of these partitions, sq ft
- $UP_k$ : Overall heat transfer coefficient for each of these partition walls, Btu per (hr) (sq ft) (F), where  $k = 1, 2, \dots NP$

Underground Walls:

- NG: Number of underground walls
- $AG_k$ : Area of each underground wall, sq ft
- $UG_k$ : Overall heat transfer coefficient of each underground wall, Btu per (hr) (sq ft) (F), where  $k = 1, 2, \dots NG$

Underground Floors:

- NGF: Number of underground floors
- $AGF_k$ : Area of each underground floor, sq ft
- $UGF_k$ : Overall heat transfer coefficient of each underground floor, Btu per (hr) (sq ft) (F), where  $k = 1, 2, \dots NGF$

Internal Infiltration

- NLK: Number of internal air leakage sources
- $LEAK_k$ : Air leakage from each source, cfm (Calculated in INFIL), where  $k = 1, 2, \dots NLK$



External Infiltration:

- NLK': Number of external air leakage sources
- LEAK'<sub>k</sub>: Air leakage from each external source, cfm  
(Calculated in INFIL), where k = 1, 2, ...
- NLK'

Temperatures:

- TA<sub>k</sub>: Dry-bulb temperature of each adjacent space,  
F, where k = 1, 2, ... ND, NP or NLK
- DB: Outside air dry-bulb temperature, F (Obtained  
from CLIMATE)
- TG: Average ground water temperature at half under-  
ground basement depth, F
- TGW: Ground water temperature, F
- TZ: Space dry-bulb temperature, F

Humidity Ratios:

- WA<sub>k</sub>: Humidity ratio of adjacent space, lb water per  
lb dry air, where k = 1, 2, ... ND, NP or NLK
- WO: Outside air humidity ratio, lb water per lb  
dry air (Calculated in PSY)
- WZ: Space humidity ratio, lb water per lb dry air

The following heat gains are calculated in this subroutine:

HEATG Total hourly solar heat gain through windows, Btu  
 or :  
 HEATG' per hr

HEATX: Total hourly heat gain through exterior walls and  
 roofs, Btu per hr

HEATIS: Total power input to lights, Btu per hr

HEATDP: Total sensible heat gain due to heat transfer through  
 doors, partitions, underground walls and floors, and  
 internal heat sources other than lights, Btu per hr

HEATVS: Total hourly sensible heat gain due to infiltration,  
 Btu per hr

HEATL: Total hourly latent heat gain due to infiltration and  
 internal heat sources, Btu per hr

Calculation Sequence:

$$1. \begin{array}{l} \text{HEATG} \\ \text{or} \\ \text{HEATG}' \end{array} = \sum_{k=1}^{NY} AY_k * SHG_k$$

$$2. \text{HEATX} = \sum_{k=1}^{NX} AX_k * \text{HEAT}_k$$

$$3. \text{HEATIS} = \sum_{k=1}^{NS} QS_k$$

$$4. \text{HEATDP} = \sum_{k=1}^{ND} AD_k * UD_k * (TA_k - TZ) + \sum_{k=1}^{ND'} AD_k' * UK_k' (DB - TZ)$$

$$\begin{aligned}
& + \sum_{k=1}^{NY} AY_k * UY_k * (DB-TZ) + \sum_{k=1}^{NG} AG_k * UG_k * (TG-TZ)^* \\
& + \sum_{k=1}^{NGF} AGF_k * UGF_k * (TGW-TZ) + \sum_{k=1}^{NP} AP_k * UP_k * (TA_k - TZ) \\
& + \sum_{k=1}^{NS'} QS_k' \\
5. \text{ HEATVS} &= 1.08 * \left( \sum_{k=1}^{NLK} LEAK_k * (TA_k - TZ) + \sum_{k=1}^{NLK'} LEAK_k' * (DB-TZ) \right)^{**} \\
6. \text{ HEATL} &= 4775 * \left( \sum_{k=1}^{NLK} LEAK_k * (WA_k - WZ) + \sum_{k=1}^{NLK'} LEAK_k' * (WO-WZ) \right) \\
& + \sum_{k=1}^{NL} QL_k^{**} /
\end{aligned}$$

---

\* The values of UG given in the 1972 ASHRAE Handbook of Fundamentals are based on TGW. A program for calculating basement wall losses using TC has been developed at the National Bureau of Standards. When using present ASHRAE values for UG, use TGW instead of TG.

\*\* The coefficients 1.08 and 4775 in these equations are valid for the standard air density. If desired, they can be adjusted to actual conditions by multiplying both of them by  $\frac{\rho}{0.075}$ , where  $\rho$  is the actual density of the air expressed in lb per cu ft.

## HLC

### A Simplified Procedure for Obtaining Approximate Cooling Load by the Use of Weighting Factors

The procedure presented here was developed by Mitalas and Stephenson of National Research Council of Canada<sup>13, 14/</sup> in order to expedite the otherwise complex and time-consuming solution of the heat balance simultaneous equations. The rigorous solution similar to that described in RMTMP was first obtained for typical rooms in commercial buildings with pulse type excitations that simulate various heat gains. The solution for these pulse excitations were then converted into new types of transfer functions called Weighting Factors. Weighting Factors developed for typical office spaces of light, medium, and heavy constructions are shown in Tables A-13, A-14, and A-15 for solar heat gain with no internal shading devices; heat gain conduction through interior and exterior structure components, solar heat gain with interior shading devices and all internal sources except lighting; and the heat gain due to lighting. By multiplying these Weighting Factors to the history of respective heat gains in a convolution scheme, similar to the way the conduction transfer functions are multiplied to the temperature history, it is possible to calculate an approximate cooling load.

#### Data:

$AG_j$  for  $j = 0, 1, 2 \dots MG$  and  $BG_j$  for  $j = 1, 2, 3 \dots MG'$

Weighting Factors for the solar heat gain HEATG  
(no internal shading devices)

$AX_j$  for  $j = 0, 1, 2 \dots MX$  and  $BX_j$  for  $j = 1, 2 \dots MX'$

Weighting factors for

HEATX: Conduction heat gain

HEATG: Solar heat gain where there are internal shading devices

HEATDP: Heat gain due to air leakage and internal sources except lighting

$AIS_j$  for  $j = 0, 1, 2 \dots MIX$  and  $BIS_j$  for  $j = 1, 2, 3 \dots MIS'$

Weighting factors for the heat gain from lighting HEATIS

In order to make use of the weighting factor concept, it is necessary to have previous values of heat gains as well as values of cooling loads. By denoting the cooling load due to HEATG as HLCG, due to HEATX, HEATG', and HEATDP as HLCX and that due to HEATIS as HLCIS, the following set of the previous data are needed:

$HEATG_{t-j}$	for $j = 0, 1, 2 \dots MG$
$HEATX_{t-j}; HEATG'_{t-j}; HEATDP_{t-j}$	for $j = 0, 1, 2 \dots MX$
$HEATIS_{t-j}$	for $j = 0, 1, 2, 3 \dots MIS$
$HLCG_{t-j}$	for $j = 1, 2, 3 \dots MG'$
$HLCX_{t-j}$	for $j = 1, 2, 3 \dots MX'$
$HLCIS_{t-j}$	for $j = 1, 2, 3 \dots MIS'$

#### Calculation Sequence:

1. Using the Weighting Factors\* given in Tables A-13, A-14, and

---

\* The Weighting Factors given in Tables A-13, A-14, and A-15 are for typical office construction. They are obtained using the method described in Appendix B.

A-15 and factor  $F_c$  defined by equation "d", calculate load components corresponding to the heat gains

$$a. \text{HLCG}_t = F_c \sum_{j=0}^{MG} AG_j * \text{HEATG}_{t-j} - \sum_{j=1}^{MG'} BG_j * \text{HLCG}_{t-j}$$

$$b. \text{HLCX}_t = F_c \sum_{j=0}^{MX} AX_j * (\text{HEATX}_{t-j} + \text{HEATG}'_{t-j} + \text{HEATDP}_{t-j}) - \sum_{j=1}^{MX'} BX_j * \text{HLCX}_{t-j}$$

$$c. \text{HLCIS}_t = F_c \sum_{j=0}^{MIS} AIS_j * \text{HEATIS}_{t-j} - \sum_{j=1}^{MIS'} BIS_j * \text{HLCIS}_{t-j}$$

The coefficients given in Tables A-13, A-14, and A-15 are for the case where all the heat gain energy appears eventually as cooling load. In most cases, a fraction of the input is lost to the surroundings. This fraction depends on the thermal conductance between the room air and the surroundings. One estimate of this fraction  $F_c$ , is given by

$$d. F_c = 1 - 0.02 K_T \dots$$

for the range  $1.0 > F_c > 0.7$

$$\text{where } K_T = \frac{1}{L_F} (U_{\text{window}} A_{\text{window}} + U_{\text{exterior wall}} A_{\text{exterior wall}*} + U_{\text{corridor wall}} A_{\text{corridor wall}})$$

\* A U\*A product should also be included for walls that adjoin unconditioned spaces even though the walls are not exterior ones.



$L_F$  = Length of room exterior perimeter

U = U value of the room enclosure element

A = Area of the room enclosure element

2. Hourly load

a. Sensible load

$$SCL_t = HLCG_t + HLCX_t + HLCIS_t + HEATVS_t$$

b. Latent load

$$= HEATL_t$$

Table A-13

WEIGHTING FACTORS FOR HEATG

	Weighting Factor Symbol	Heavy* Structure	Medium* Structure	Light* Structure
MG = 1	AG <sub>0</sub>	0.187	0.197	0.224
	AG <sub>1</sub>	-0.097	-0.067	-0.044
MG' = 1	BG <sub>0</sub>	1.00	1.00	1.00
	BG <sub>1</sub>	-0.91	-0.87	-0.82

\* Heavy Structure - 6" concrete floor slab, 6" concrete exterior wall, approximately 130 lb of building material per sq ft of floor area.

Medium Structure - 4" concrete floor slab, 4" concrete exterior wall, approximately 70 lb of building material per sq ft of floor area.

Light Structure - 2" concrete floor slab, exterior frame wall approximately 30 lb of building material per sq ft of floor area.

Table A-14

## NORMALIZED WEIGHTING FACTORS FOR HEATX + HEATG' + HEATDP

	Weighting Factor Symbol	Heavy Structure	Medium Structure	Light Structure
MX = 1	AX <sub>0</sub>	0.676	0.681	0.703
	AX <sub>1</sub>	-0.586	-0.551	-0.523
MX' = 1	BX <sub>0</sub>	1.00	1.00	1.00
	BX <sub>1</sub>	-0.91	-0.87	-0.82

Table A-15

## WEIGHTING FACTORS FOR HEATIS

Weighting Factor Symbol	Heavy Structure	Medium Structure	Light Structure
Fluorescent fixtures recessed into a suspended ceiling, ceiling plenum not vented.			
MIS = 2	AIS <sub>0</sub>	0.00	0.00
	AIS <sub>1</sub>	0.53	0.53
	AIS <sub>2</sub>	-0.44	-0.35
* Fluorescent fixtures recessed into a suspended ceiling, return air through ceiling plenum.			
MIS = 2	AIS <sub>0</sub>	0.00	0.00
	AIS <sub>1</sub>	0.59	0.59
	AIS <sub>2</sub>	-0.50	-0.41
Fluorescent fixtures recessed into a suspended ceiling, supply and return air through fixtures.			
MIS = 2	AIS <sub>0</sub>	0.00	0.00
	AIS <sub>1</sub>	0.87	0.87
	AIS <sub>2</sub>	-0.78	-0.69

\* Manufacturer's data sheet must be consulted to obtain the fractions of light input energy that are picked up by the room air and by ventilation air in the ceiling plenum.

Table A-15 continued

Weighting Factor Symbol	Heavy Structure	Medium Structure	Light Structure
Incandescent lights exposed in the room air.			
	0.00	0.00	0.00
MIS = 2	0.50	0.50	0.50
	-0.41	-0.37	-0.32
The "BIS" Coefficients.			
	1.00	1.00	1.00
MIS' = 1	-0.91	-0.87	-0.82

RMRT

An Algorithm for Calculating Weighting  
Factors for Space Air Temperature

This algorithm provides a sample calculation method for obtaining the weighting factors for deviation of space temperature for the design value; the value at which the space heating/cooling loads are obtained for by the HLC routine.

This general algorithm illustrated here is for a space enclosure surrounded with spaces on both sides as well as above and below that are thermally at the same conditions. The space enclosure consists of an external wall, interior partition walls, corridor partition wall, ceiling, floor, furnishings, an outside door and a window.

Data:

AF: Floor area, sq ft

AC: Ceiling area, sq ft

AP: Interior partition wall area, sq ft

AK: Corridor wall area, sq ft

AW: Exterior wall area, sq ft

AG: Window glass area, sq ft

AD: Door area, sq ft

AFN: Internal furnishings area, sq ft

$BF_j$  Transfer functions for floor, Btu per (hr) (sq ft)

$CF_j$ : (F), (Calculated in XYZ)

$DF_j$

$BC_j$       Transfer functions for ceiling, Btu per (hr) (sq ft)  
 $CC_j$       (F), (Calculated in XYZ)  
 $DC_j$   
 $BK_j$       Transfer functions for corridor wall, Btu per (hr)  
 $DK_j$       (sq ft) (F), (Calculated in XYZ)  
  
 $BP_j$       Transfer functions for interior partition walls, Btu  
 $CP_j$       per (hr) (sq ft) (F), (Calculated in XYZ)  
 $DP_j$   
 $CW_j$       Transfer functions for exterior walls, Btu per (hr)  
 $DW_j$       (sq ft) (F), (Calculated in XYZ)  
  
 $CD_j$       Transfer functions for outside door, Btu per (hr)  
 $DD_j$       (sq ft) (F), (Calculated in XYZ)  
  
 $CFN_j$       Transfer functions for internal furnishings, Btu per  
 $DFN_j$       (hr) (sq ft) (F), (Calculated in XYZ)

where  $j = 0, 1, \dots, M$

UG: Heat transmission coefficient of window glass, Btu  
 per (hr) (sq ft) (F)

CFM: Rate of air flow through the room, cu. ft per min.  
 (Ventilation rate)



Calculation Sequence:

1. Conversion of the given transfer functions into single series  $x_j$ ,  $y_j$ , and  $z_j$ . This calculation is a polynomial division\*, i.e.,

$$\begin{aligned} & x_0 z^0 + x_1 z^{-1} + x_2 z^{-2} + x_3 z^{-3} + \dots \\ &= \frac{a_0 z^0 + a_1 z^{-1} + a_2 z^{-2} + \dots}{1 + b_1 z^{-1} + b_2 z^{-2} + b_3 z^{-3} + \dots} \end{aligned}$$

where

$x_0, x_1, x_2 \dots$  = single series response factor set

$a_0, a_1, a_2 \dots$  and

$b_1, b_2, b_3 \dots$  = coefficient of the given numerator

and denominator series respectively

For example, using given notation in this section for the outside wall, the x's, a's and b's are

$x_0 = sCW_0$	$a_0 = CW_0$	$b_0 = 1.0$
$x_1 = sCW_1$	$a_1 = CW_1$	$b_1 = DW_1$
$x_2 = sCW_2$	$a_2 = CW_2$	$b_2 = DW_2$
.	.	$b_3 = DW_3$
.	.	.
.	.	.

---

\* The rules of polynomial division can be obtained from any standard textbooks on numerical analysis.

where the letter "s" in front of  $CW_j$  denotes coefficients of the single series

2. Calculation of the single series of Room Air Response Factors, sRMRT. The factors in this series are given by

$$\begin{aligned} \text{sRMRT}_j = & \text{AF}[\text{sBF}_j + \text{sCF}_j] \\ & + \text{AC}[\text{sDC}_j + \text{sCC}_j] \\ & + \text{AP}[\text{sBP}_j + \text{sCP}_j] \\ & + \text{AW}[\text{sCW}_j] \\ & + \text{AD}[\text{sCD}_j] \\ & + \text{AFN}[\text{sCFN}_j] \\ & + \text{AG}[\text{UG}_j]^* \\ & + 1.08[\text{CFM}_j]^* \end{aligned}$$

where  $j > 10$  calculate the ratio  $R_j$

$$R_j = \frac{\text{sRMRT}_{j+1}}{\text{sRMRT}_j}$$

and when  $|R_j - R_{j+1}| \leq 0.001$  terminate sRMRT<sub>j</sub> calculations.

3. Calculation of RMRT

The calculation of RMRT as a ratio of two series consists of three steps:

- (a) Calculation of denominator,  $D(z)$ ,

$$D(z) = 1.0 - Rz^{-1}$$

where  $R$  is the last value of the ratio calculated in the sRMRT<sub>j</sub> calculations

---

\* Note that  $UG_{j=1} = UG$ ,  $CFM_{j=1} = CFM$ ,  $UG_{j>1} = 0.0$  and  $CFM_{j>1} = 0.0$ .

(b) Calculation of numerator,  $N(z)$ ,

$$\begin{aligned} N(z) = & \text{sRMRT}_0 z^0 + (\text{sRMRT}_1 - (R)\text{sRMRT}_0) z^{-1} \\ & + (\text{sRMRT}_2 - (R)\text{sRMRT}_1) z^{-2} \\ & + (\text{sRMRT}_3 - (R)\text{sRMRT}_2) z^{-3} \end{aligned}$$

(c) The RMRT's are then evaluated by equating the following equation to the one in (b) above

$$N(z) = \frac{X_0 + X_1 z^{-1} + X_2 z^{-2}}{Y_0 + Y_1 z^{-1}}$$

Typical values are shown in Table A-16.

Table A-16

WEIGHTING FACTORS FOR THE DEVIATION OF SPACE  
TEMPERATURE,  $RMRT'S^*/$

	Weighting Factor Symbol	Heavy Structure	Medium Structure	Light Structure
	$X_0$	-1.85	-1.81	-1.68
	$X_1$	+1.95	+1.89	+1.73
MX = 2	$X_2$	-0.10	-0.08	-0.05
	$Y_0$	1.00	1.00	1.00
MY = 1	$Y_1$	-0.91	-0.87	-0.82

---

\* The X coefficients given in this Table are for a room with zero heat conductance to surrounding spaces and are normalized to unit floor area. To get the  $X_j$  coefficients for a room with a total conductance K between room air and surroundings, ventilation rate  $V_t$  and infiltration rate  $VI_t$ , it is necessary to multiply each  $X_j$  value by room floor area and then add  $[K + (V_t + VI_t) 1.08] (1.00 - Y_j)$  to the resulting  $X_0$  value (where  $V_t$  and  $VI_t$  are in cfm and K is in Btu/hr °F).

Note: That  $X_0$  value changes with the changes of  $V_t$  and  $VI_t$  values.

## HEXT

An Algorithm for Calculating the Rate at Which  
Sensible Heat is Extracted From the Space

### Data:

- $SCL_t$ : Sensible cooling load at time  $t$ , which is calculated for a constant space design temperature of  $T_M$ , Btu per hr (Calculated in HCL)
- $X_j$ : Weighting factors for use with  $\theta_{t-j}$ , for  $j = 0, 1, \dots$ ,  
 $Y_j$ : (Calculated in RMRT with typical values shown in Table A-16)
- $\theta_{t-j}$ : History of hourly space air temperature deviation from the assumed constant value  $T_M$ , for  $j = 1, 2 \dots$ , F
- C: Average heat extraction rate of the apparatus in a space when the space air temperature is  $T_M$ , Btu per hr
- D: Change in the rate of heat extraction of the apparatus caused by one degree change in space air temperature, Btu per (hr) (F)
- $HE_{t-j}$ : History of heat extracted from the space, for  $j = 1, 2 \dots$ , Btu per hr

## INFIL

### An Algorithm for Calculating Air Infiltration

It is well recognized that the air infiltration constitutes as much as 30% of home heating load and a significant part of the load of non-pressurized commercial buildings. The air leakage of a building depends upon the tightness of its exterior walls, windows, and doors; the wind characteristics and temperature difference between the inside and outside, and to some extent how the building is operated with respect to the opening and closing of its door.

The rate of air infiltration can be empirically expressed by

$$Q = C * A * \Delta P ** N$$

where

Q: air flow rate

C: flow coefficient

A: flow opening area

N: pressure exponent

$\Delta P$ : pressure difference

Unfortunately it is very difficult to determine accurate values of flow opening area and pressure difference for actual buildings, which consist of complex air leakage passages. A limited amount of data are given in the 1972 ASHRAE Handbook of Fundamentals for equivalent opening area of typical windows, doors and walls. The pressure difference depends upon the wind characteristics around the building and the temperature differ-



ence between the inside and the outside of the building.

Compiled in this section is a methodology to approximately calculate the pressure difference between a given space and its adjacent space including the outdoor. The basic mathematical principle involved is to attain a solution to a set of pressure difference equations of the following type:

$$Q_i = \sum Q_{i,k} = 0$$

$$Q_{i,k} = \sum A_{i,k} * C_{i,k} * (P_i - P_k)^{**} N_{i,k}$$

where

- $Q_i$ : net air flow out of space i
- $Q_{i,k}$ : air exchange between space i and space k
- $A_{i,k}$ : flow opening area between space i and k
- $C_{i,k}$ : flow coefficient applicable to the air flow between the spaces i and k
- $N_{i,k}$ : pressure exponent applicable to the flow between the spaces i and k

A special computational routine is required to solve this set of simultaneous, non-linear equations.

As mentioned previously, air leakage through various openings such as doors, windows, window frames, pinholes in the wall and service shafts may be approximated by an equation of the following type:

$$\begin{aligned} \text{LEAK} &= 4000 * A * K * (\text{DP}) ** N \\ &= C * (\text{DP}) ** N \end{aligned}$$

where

LEAK = air leakage in cu. ft per min.

A = opening area, sq ft

K = flow coefficient, dimensionless

DP = pressure difference across the opening, inches of water

N = pressure exponent, dimensionless

C = equivalent flow coefficient (EFC)

The values of K and N vary depending upon the type of opening. Moreover, the exact value of A is not well known for many types of openings, such as wall pinholes or cracks around the windows. Table A-17 lists the values of Equivalent Flow Coefficient C and the flow exponent N for various types of openings common to many buildings. These values are derived from the air leakage data compiled in Chapter 19 "Infiltration and Natural Ventilation" of the 1972 ASHRAE Handbook of Fundamentals.

Table A-17

	<u>C</u>	<u>N</u>
1. Double-hung wooden windows (locked)*		
non-weatherstripped loose fit	6	0.66
average fit	2	0.66
weatherstripped loose fit	2	0.66
average fit	1	0.66
2. Window frames*		
masonry frame with no caulking	1.2	0.66
masonry frame with caulking	0.2	0.66
wooden frame	1	0.66
3. Swinging doors* 1/2" crack	160	0.5
1/4" crack	80	0.5
1/8" crack	40	0.5
4. Walls**		
8" plain brick	1	0.8
8" brick and plaster	0.01	0.8
13" brick	0.8	0.8
13" brick and plaster	0.004	0.7
13" brick, furring, lath and plaster	0.03	0.9
frame wall, lath and plaster	0.01	0.55
24" shingles on 1 x 6 boards on 14" center	9	0.66
16" shingles on 1 x 4 boards on 5" center	5	0.66
24" shingles on shiplap	3.6	0.7
16" shingles on shiplap	1.2	0.66

---

\* Values of C listed for these openings are per ft of linear crack length.

\*\* Values of C listed for the walls are per unit area of the wall surface.

In many instances, detailed information of air leakage characteristics is not available, but it is still possible to make a calculation. For a modern office building of 120 ft x 120 ft plan dimension with the floor height of 12 ft, Tamura<sup>15/</sup> lumped together all the leakage area for a given floor as follows:

Table A-18

outside wall	2.5 sq. ft per story
4 elevator shaft doors	4.5 " " " "
2 stair shaft doors	0.5 " " " "
floor	3.7 " " " "
branch perimeter and interior air duct	7.0 " " " "
return duct	14.0 " " " "
vertical shafts (elevator or stairwell)	1/3 of the cross-sectional area*

The value of C corresponding to these data can be obtained by multiplying them by 2400 which corresponds to  $K = 0.6$ .

Data:

V: Wind speed measured at a 40 ft elevation as taken from the weather tape, knots

DIR: Wind direction measured clockwise from North, degrees  
(see Figure A-21)

---

\* This particular data were derived from a recent and unpublished experiment of the National Bureau of Standards conducted on two high-rise buildings.

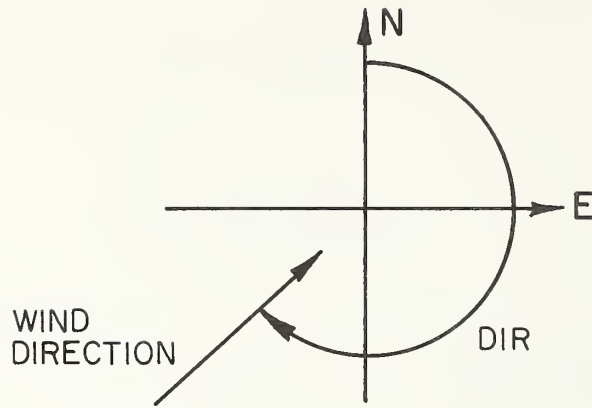

Figure A-21 Definition of Wind Direction Angle

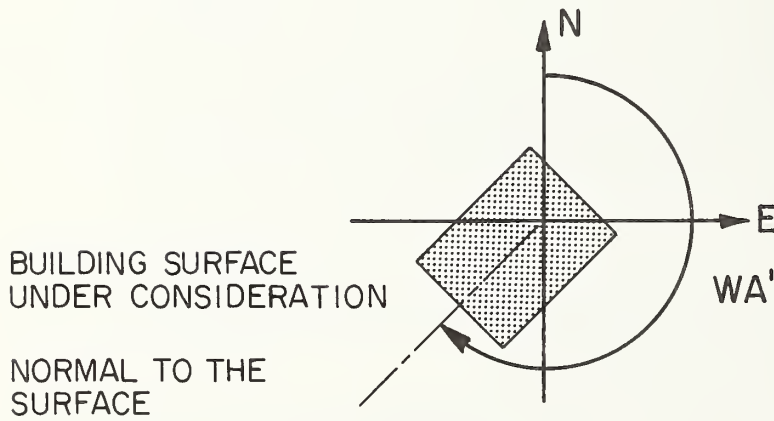

Figure A-22 Definition of the Angle Between North and Normal of the surface Under Consideration

- DB: Outdoor air dry-bulb temperature, F
- PB: Barometric pressure, in. Hg.
- NF: Number of above-grade floors
- HTT: Total height of building (from above-grade), ft
- TZ: Indoor air temperature, F
- TS: Elevator and service shaft temperature
- WA': Direction angle of the building as defined with respect to North and the normal of the principal surface of the building (see Figure A-22)
- HT<sub>k</sub>: Height of the floor, ft, for k = 1, 2, 3, .... NF
- CFMSP<sub>k</sub>: Ventilation air supplied to the floor, cu ft per min, for k = 1, 2, 3, ... NF
- CFMEX<sub>k</sub>: Ventilation air exhausted from the floor, cu ft per min, for k = 1, 2, 3, ... NF

Calculation Sequence:

1.  $V' = 1.153 * V$   
 $TO = 460 + DB$   
 $TI = 460 + TZ$   
 $PO = 0.4910 * PB$   
 $x = DIR - WA'$
2. Wind velocity, VH, at height HT on the building, mph  
 $VH = V' * 0.117 * (1 + 2.81 * \text{Log} (0.305 * HT + 4.75))$
3. Theoretical wind velocity pressure, PTWV on the building, in. H<sub>2</sub>O  
 $PTWV = 0.000482 * (V ** 2)$



4. Wind direction, BWD, relative to building surfaces

BWD = 1 surface on windward side if,

$$-45^\circ < x < +45^\circ$$

BWD = 2 surface on leeward side if,

$$90^\circ < x < 270^\circ$$

or,  $-90^\circ < x < -270^\circ$

BWD = 3 surface on side if,

$$45^\circ < x < 90^\circ$$

or,  $-45^\circ < x < 90^\circ$

5. Using Table A-19, determine the normal wind velocity pressure correction factor, PTKN

Table A-19 Values of PTKN

NSB	TB = 1			TB = 2			TB = 3		
	BWD = 1	BWD = 2	BWD = 3	BWD = 1	BWD = 2	BWD = 3	BWD = 1	BWD = 2	BWD = 3
0.5	.1	-.3	-.8	-.5	-.25	-.45	.5	.45	.45
1.0	-.1	-.25	-.5	-.5	-.2	-.3	.45	.3	.3
2.0	.1	-.25	-.4	.0	-.2	-.3	.45	.1	.1
3.0	.1	-.25	-.4	.1	-.2	-.35	.45	.0	.0
5.0	.25	-.35	-.6	.25	-.25	-.45	.5	-.1	-.1
$\infty$	.6	-.35	-.7	.6	-.35	-.7	.6	-.35	-.7

where

TB = 1: Shorter building on windward side

TB = 2: Equals taller building on windward side

TB = 3: Taller building on leeward side

NSB: Ratio of the distance between the adjacent buildings and the width of the building in the direction of wind

6. Wind velocity pressure correction factor, PTKO, for winds obliquely to the wall surface

If BWD = 1 (windward side of building)

$$(PTKO)_m = \text{Cos} ( | x | )$$

If BWD = 2 (leeward side of building)

$$(PTKO)_l = 1.0$$

If BWD = 3 (side of building)

$$(PTKO)_s = \text{Cos} ( | x | )$$

Example:

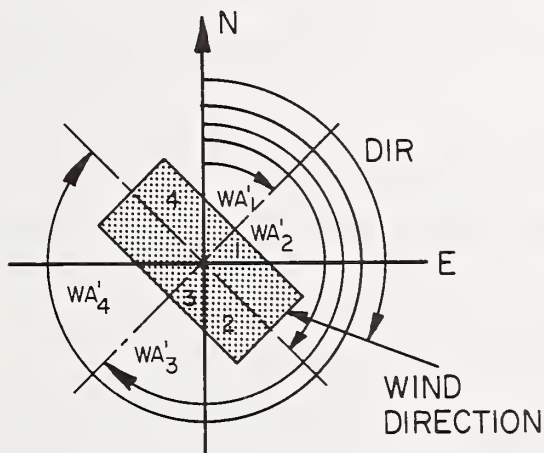

DIR = 110°

WA<sub>1</sub>' = 45°

WA<sub>2</sub>' = 135°

WA<sub>3</sub>' = 225°

WA<sub>4</sub>' = 315°

Figure A-23 DIR and WA' Angles of Example

Side 1,  $DIR-WA_1' = 110^\circ - 45^\circ = 65^\circ$  (therefore, BWD = 3)

Side 2,  $DIR-WA_2' = 110^\circ - 135^\circ = -25^\circ$  (therefore, BWD = 1)

Side 3,  $DIR-WA_3' = 110^\circ - 225^\circ = 115^\circ$  (therefore, BWD = 2)

Side 4,  $DIR-WA_4' = 110^\circ - 205^\circ = 205^\circ$  (therefore, BWD = 2)

Side 1,  $(PTKO)_s = \text{Cos } (+65^\circ)$

Side 2,  $(PTKO)_m = \text{Cos } (+25^\circ)$

Side 3,  $(PTKO)_1 = 1.0$

Side 4,  $(PTKO)_1 = 1.0$

7. Actual wind pressure on the building at height (HT) corresponding to floor (k):  $(PAWV)_k$

$$(PAWV)_k = (PTKO)_k * (PTKN)_k * (PTWV),$$

8. Stack effect pressure (PSE) on the outside of the building at building height (HT) and floor (k), in.  $H_2O$

$$(PSE)_k = -0.52 * PO * HT/TO$$

9. Total pressure on the outside of the building (PCO) at floor (k), in.  $H_2O$

$$(PCO)_k = (PAWV)_k + (PSE)_k$$

10. Pressure in the elevator and serve shafts (PSE) at height (HT) corresponding to floor (k), in.  $H_2O$

$$(PSE)_k = -0.52 * PO * HT/TI + (PSE)_1$$

11. Choose appropriate flow coefficients and pressure exponents for air leakage paths of each floor as follows:

Flow coefficients

CWD: Value of C for appropriate window in Table A-17 multiplied by the total crack length of all the windows

CFM: Value of C for appropriate window frame in Table A-17 multiplied by the total crack length of all the window frames

CDR: Value of C for appropriate door in Table A-17 multiplied by the total crack length of all the doors

CWL: Value of C for appropriate walls in Table A-17 multiplied by the total wall area

CCL: Value of A for the ceiling from Table A-18 multiplied by 2400

CFL: Value of A for the floor from Table A-18 multiplied by 2400

CEL: Value of C for elevator doors

CSS: Value of C for the doors to the service shaft

CFS and CES: Value of the cross section of the shaft multiplied by 800

#### Pressure exponent

NWD: Value of N for the appropriate window in Table A-17

NFM: Value of N for the appropriate window frame in Table A-17

NDR: Value of N for the appropriate door in Table A-17

NWL: Value of N for the appropriate wall in Table A-17

NCL: 0.5

NFL: 0.5

NEL: 0.5

NSS: 0.5

NFS: 0.5

NSE: 0.5

## 12. Solution of 2 \* NF equations

Outdoor air leakage to k-th floor rooms\* (see Figure A-23)

Window k leakage

$$\text{LEAKWD}_{k,j} = \text{CWD}_{k,j} * (\text{PCO}_{k,j} - \text{PI}_k) ** \text{NWD}_{k,j} \quad (1)$$

Window frame leakage

$$\text{LEAKFM}_{k,j} = \text{CFM}_{k,j} * (\text{PCO}_{k,j} - \text{PI}_k) ** \text{NFM}_{k,j} \quad (2)$$

Door leakage

$$\text{LEAKDR}_{k,j} = \text{CDR}_{k,j} * (\text{PCO}_{k,j} - \text{PI}_k) ** \text{NDR}_{k,j} \quad (3)$$

Wall leakage

$$\text{LEAKWL}_{k,j} = \text{CWL}_{k,j} * (\text{PCO}_{k,j} - \text{PI}_k) ** \text{NWL}_{k,j} \quad (4)$$

Ceiling leakage

$$\text{LEAKCL}_k = \text{CCL}_k * (\text{PI}_{k+1} - \text{PI}_k) ** \text{NCL}_k \quad (5)$$

Floor leakage

$$\text{LEAKFL}_k = \text{CFL}_k * (\text{PI}_{k-1} - \text{PI}_k) ** \text{NFL}_k \quad (6)$$

---

\* In all of above expressions, subscript k refers to the k-th floor and subscript j refers to the j-th side of the building where the convention is j = 1 (south), 2 (west), 3 (north), and 4 (east).

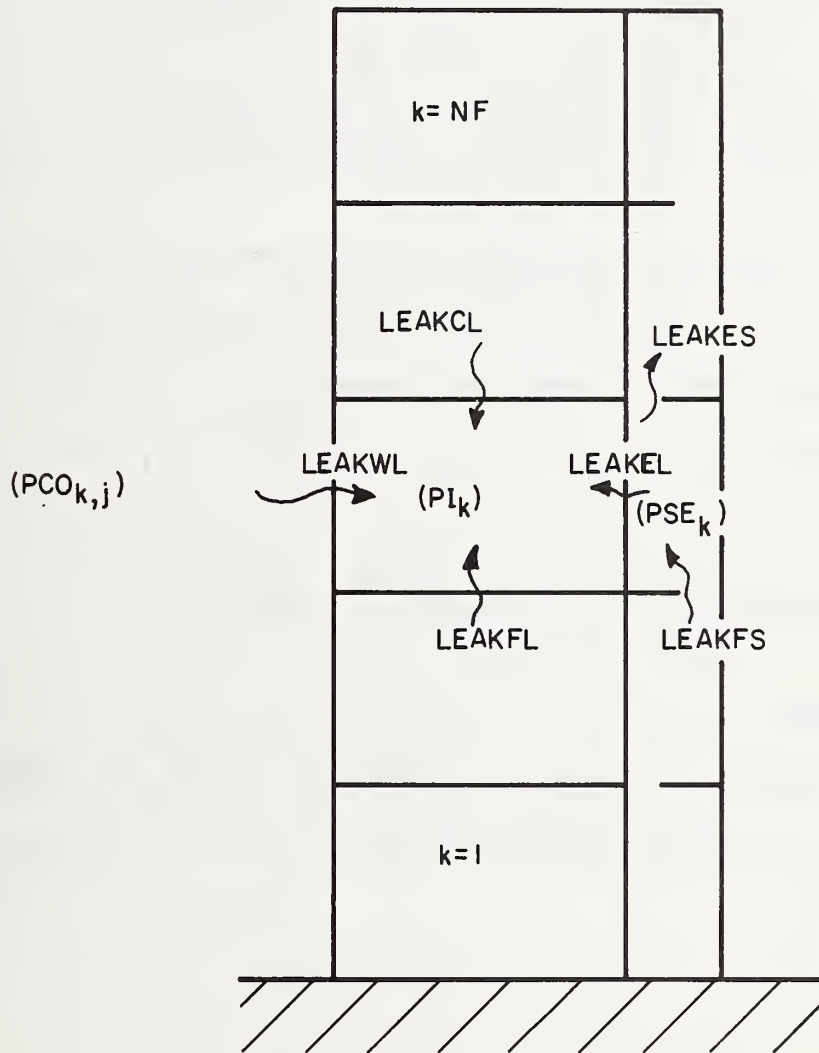

Figure A-23 Air Leakage Pattern of a High-Rise Building



Leakage from the elevator and service shafts\*

$$\text{LEAKEL}_k = \text{CEL}_k * (\text{PSE}_k - \text{PI}_k) ** \text{NEL}_k \quad (7)$$

$$\text{LEAKSS}_k = \text{CSS}_k * (\text{PSE}_k - \text{PI}_k) ** \text{NSS}_k \quad (8)$$

Air leakage between the floor levels within the shafts<sup>\*/</sup>

$$\text{LEAKFS}_k = \text{CFS}_k * (\text{PSE}_{k-1} - \text{PSE}_k) ** \text{NFS}_k \quad (9)$$

$$\text{LEAKES}_k = \text{CES}_k * (\text{PSE}_{k-1} - \text{PSE}_k) ** \text{NSE}_k \quad (10)$$

In the previous equations, unknowns are  $\text{PI}_k$  for  $k = 1, 2, 3, \dots, \text{NF}$  and  $\text{PSE}_k$  for  $k-1, 2, 3, \dots, \text{NF}$  provided that the pressures in all the shafts are assumed equal at a given floor level.

Flow balance equations at the  $k$ -th floor (the individual quantities come from equations 1-10 above)

Rooms

$$\begin{aligned} &\text{LEAKWD}_{k,j} + \text{LEAKFM}_{k,j} + \text{LEAKDR}_{k,j} + \text{LEAKWL}_{k,j} + \text{LEAKCL}_k \\ &+ \text{LEAKFL}_k + \text{LEAKEL}_k + \text{LEAKSS}_k + \text{CFMSP}_k - \text{CFMEX}_k = 0 \end{aligned}$$

---

\* In all of above expressions, subscript  $k$  refers to the  $k$ -th floor and subscript  $j$  refers to the  $j$ -th side of the building where the convention is  $j = 1$  (south),  $2$  (west),  $3$  (north), and  $4$  (east).

Elevator Shaft or Service Shaft

$$\text{LEAKFS}_k + \text{LEAKES}_k - \text{LEAKEL}_k^* + \text{CFMSPS}_k - \text{CFMEXS}_k = 0$$

where  $\text{CFMSPS}_k$ : ventilation air supplied at the  
k-th floor in the shaft

$\text{CFMEXS}_k$ : air exhausted from the shaft at  
the k-th floor

These  $2 * \text{NF}$  sets of flow balance equations must be solved by an appropriate iteration technique to obtain the pressure profiles in the building and in the shafts. Then the calculated pressure values are used to determine the air leakage of the building.

Recently a comprehensive computer program that embodies the basic algorithm described in this section was published by D. M. Sander and G. T. Tamura of the National Research Council of Canada. The details of the program are given in an NRC booklet entitled "A Fortran IV Program to Simulate Air Movement in Multi-Storey Buildings", DBR Computer Program No. 35, (March 1973).

---

\* If this equation were for a service shaft,  $\text{LEAKEL}_k$  would be replaced by  $\text{LEAKES}_k$ .

## DST

### An Algorithm for Determining the Dates of the Daylight Savings Time

#### Data:

YR: Year AD

MO: Month of the year

DAY: Day of the month

The main variables calculated in this subroutine are:

DSTX: The day when daylight savings time commences

DSTY: The day when standard time resumes

DST: The daylight savings time indicator

DST = 0 during the standard time period  
1 during the daylight savings time period

#### Calculation Sequence:

1. If MO is less than 4 or greater than 10, DST = 0  
If MO is greater than 4 and less than 10, DST = 1
2. If MO = 4, DAY is less than 25, DST = 0  
If DAY is greater than 23, call WKDAY subroutine  
If DAY is Sunday, DSTX = DAY  
If DAY is less than DSTX, DST = 0, otherwise DST = 1
3. If MO = 10, DAY is less than 25, DST = 1  
If DAY is greater than 24, call WKDAY subroutine  
If DAY is Sunday, DSTY = DAY  
If DAY is less than DSTY, DST = 1, otherwise DST = 0

## WKDAY

An Algorithm Used to Identify the Day of the Week for Any Given  
Date of the Year From 1901 to 2000

### Data:

YR: Year AD

MO: Month of the year

DAY: Day of the month

The variable calculated in this subroutine is WKDAY, the weekday indicator.

	1	if Sunday
	2	if Monday
	3	if Tuesday
WKDAY =	4	if Wednesday
	5	if Thursday
	6	if Friday
	7	if Saturday

### Calculation Sequence:

1. Let  $FSTDAY(1) = 31$ ,  $FSTDAY(2) = 59$ ,  $FSTDAY(3) = 90$ ,  $FSTDAY(4) = 120$

$FSTDAY(5) = 151$ ,  $FSTDAY(6) = 181$ ,  $FSTDAY(7) = 212$ ,  $FSTDAY(8) = 243$

$FSTDAY(9) = 273$ ,  $FSTDAY(10) = 304$ ,  $FSTDAY(11) = 334$ ,  $FSTDAY(12) = 365$

2. Let  $N = \text{Integer part of } YR/4$

$ND = N - 485$

$IY = 2$ ,  $IADD = 2$

If  $ND = 0$ , Go to (4)

If  $ND$  is less than 0,  $ND = -ND$  and  $IADD = -2$

3. Repeat the following steps for ND times
  - IY = IY - IADD
  - If IY is greater than 7, IY = IY - 7
  - If IY is equal to 0, IY = 7
  - If IY is less than 0, IY = IY + 7
4. Let MD = YR - N \* 4
  - If MD is equal to 0 IWK = IY
  - If MD is equal to 1 IWK = IY + 2
  - If MD is equal to 2 IWK = IY + 3
  - If MD is equal to 3 IWK = IY + 4
  - If IWK is greater than 7, IWK = IWK - 7
  - If MO is not equal to 1 go to 5
  - TDAY = DAY - 1
  - Go to 7
5. Repeat the following for j = 2 through 12
  - If MO is equal to j, let TDAY = FSTDAY (j-1) + Day - 1
  - Otherwise Go to 6
6. If MD is equal to 0 and MO is greater than 2, TDAY = TDAY + 1
7. Let NTX = Integer part of TDAY/7
  - NDX = TDAY - 7 \* NTX + IWK
  - If NDX is greater than 7, let NDX = NDX - 7
8. Let WKDAY = NDX
9. If this routine is going to be applied for the period outside 1901-2000, the following additional algorithms must be added
  - KV = First two digits of YR

KTEST = Last two digits of YR  
 If  $MO \leq 2$  or  $KTEST = 0$ ,  $KV = KV - 1$   
 LTEST = Remainder of  $KV/4$   
 $KV = 4*LV + LTEST$   
 If  $LTEST = 2$ ,  $WKDAY = WKDAY + 1$   
      $= 1$ ,  $WKDAY = WKDAY + 2$   
      $= 0$ ,  $WKDAY = WKDAY + 3$   
 Otherwise  $WKDAY = WKDAY - 3*(LV - 4)$   
 If  $WKDAY < 0$ ,  $WKDAY = WKDAY + 7$   
 If  $WKDAY > 7$ ,  $WKDAY = WKDAY - 7$

An alternate calculation sequence for WKDAY has been suggested\*

\*\*\*\*\* ALL INTEGER ARITHMETIC \*\*\*\*\*

```

1  MDAY=30*(MO-1)+(MO-2)*58/100-1
   IF (MO.LE.2) MDAY=MDAY+MO

2  NIVC=IYR-(IYR/400)*400
   NLYR=NIVC/4
   NCEN=NIVC/100
   NIC=NIVC-100*NCEN

3  IY=6-2*NLYR

4  MD=NIVC-NLYR*4
   IF (MD.GE.1) IY=IY+1+MD
   IY=IY-NCEN
   IF (NIC.EQ.0.AND.NIVC.GT.0) IY=IY+1

5  IDAYR=MDAY+IDA

6  IF (NIC.EQ.0.AND.NCEN.GE.1) GO TO 7
   IF (MD.EQ.0.AND.MO.GT.2) IDAYR=IDAYR+1

```

---

\* This was contributed by A. W. Courtney, Scientific Programming,  
 Box 508, Bloomfield Hills, Michigan 48013.



7 JWK=IDAYR+IY  
NDX=JWK-(JWK/7)\*7  
IF (NDX·LE·Ø) NDX=NDX+7

8 WKDAY=NDX

NOTE: IDA FORMERLY CALLED "DAY"  
IYR FORMERLY CALLED "YR"  
IDAYR = NUMBER OF THE DAY OF THE YEAR  
Ø = NUMERICAL ZERO

## HOLIDAY

### An Algorithm to Identify the National Holidays of the United States of America

Simple modifications allow the identification of any holidays or any special days in any country as long as the Gregorian Calendar system is employed.

#### Data:

YR: Year AD

MO: Month

DAY: Day of the month

The primary variable calculated in this subroutine is HOL, the holiday indicator; it is 1 if the date is a holiday and zero if it is a non-holiday.

#### Calculation Sequence:

HOL = 1

If MO = 1 and DAY = 1

MO = 12, DAY = 31 and WKDAY = 6

MO = 1, DAY = 2 and WKDAY = 2

MO = 2,  $22 > \text{DAY} \geq 15$  and WKDAY = 2

MO = 5,  $\text{DAY} \geq 25$  and WKDAY = 2

MO = 7 and DAY = 4

MO = 7, DAY = 3 and WKDAY = 6

MO = 7, DAY = 5 and WKDAY = 2

MO = 9,  $7 > \text{DAY}$  and WKDAY = 2

MO = 10,  $15 > \text{DAY} \geq 8$  and WKDAY = 2

MO = 10,  $29 > \text{DAY} \geq 22$  and WKDAY = 2

MO = 11,  $29 > \text{DAY} > 21$  and WKDAY = 5

MO = 12, DAY = 24 and WKDAY = 6

MO = 12, DAY = 26 and WKDAY = 2

otherwise HOL = 0

## PSY\*

### Various Algorithms for Approximate Psychrometric Calculations

The following symbols are used throughout the PSY subroutines:

- DB: Dry-bulb temperature, F (determined in CLIMATE)
- DP: Dewpoint temperature, F (determined in CLIMATE)
- WB: Wet-bulb temperature, F (determined in CLIMATE)
- t: Temperature, either DB, WB, or DP, F
- PB: Barometric pressure, in. Hg (determined in CLIMATE)
- H: Enthalpy of moist air, Btu per lb of dry air
- HS: Enthalpy of moist air saturated with water vapor,  
Btu per lb of dry air
- PV: Partial pressure of water vapor in moist air, in. Hg
- PVS: Partial pressure of water vapor in moisture saturated  
air, in. Hg
- V: Volume of moist air, cu ft per lb of dry air
- W: Humidity ratio of moist air, lb of water vapor per  
lb dry air
- log(x): Natural logarithm of x
- log<sub>10</sub>(x): Common logarithm of x

---

\* When the exact Goff-Gratch method is required, algorithms described in Reference 17 should be used. Tables A-19 and A-20 taken from that reference list that the psychrometric properties calculated by the PSY routines and the exact Goff-Gratch method, respectively. From examination of these tables it can be seen that the values calculated by the PSY subroutines are in very good agreement with the values calculated by the exact Goff-Gratch method.

The following algorithms are used for calculating the psychrometric properties of moist air. All of these are not required for load calculations but are presented here in a package and can be applied in a variety of engineering applications.

a. PVS (t)

1. Let	A(1) = -7.90298	B(1) = -9.09718
	A(2) = 5.02808	B(2) = -3.56654
	A(3) = -1.3816 E-7	B(3) = 0.876793
	A(4) = 11.344	B(4) = 0.0060273
	A(5) = 8.1328 E-3	
	A(6) = -3.49149	

2. Let  $T = (t + 459.688)/1.8$   
if T is less than 273.16, go to 3

Otherwise

Let  $z = 373.16/T$   
 $P1 = A(1) * (z-1)$   
 $P2 = A(2) * \log_{10}(z)$   
 $P3 = A(3) * (10^{A(4) * (1-1/z)}) - 1$   
 $P4 = A(5) * (10^{A(6) * (z-1)}) - 1$

Go to 4.

3. Let  $z = 273.16/T$   
 $P1 = B(1) * (z-1)$   
 $P2 = B(2) * \log_{10}(z)$   
 $P3 = B(3) * (1-1/z)$   
 $P4 = \log_{10}(B(4))$

4.  $PVS = 29.921 * (10^{P1 + P2 + P3 + P4})$

b. PV (DB, WB, PB)

1.  $PVP = PVS (WB)$

$$WS = 0.622 * PVP / (PB - PVP)$$

IF  $(WB \leq 32)$  go to 3

$$HL = 1093.049 + 0.441 * DB - WB$$

$$CH = 0.24 + 0.441 * WS$$

$$WH = WS - CH * (DB - WB) / HL$$

2.  $PV = PB * WH / (0.622 + WH)$

3.  $PV = PVP - 5.704 * 10^{-4} * PB * (DB - WB) / 1.8$

c. W (DB, WB, PB)

1.  $VP = PV (DB, WB, PB)$

2.  $W = 0.622 + VP / (PB - VP)$

d. H (DB, WB, PB)

$$H = 0.24 * DB + (1061 + 0.444 * DB) * W (DB, WB, PB)$$

e. V (DB, WB, PB)

1.  $WV = W (DB, WB, PB)$

2.  $V = 0.754 * (DB + 459.7) * (1 + 7000 * WV / 4360) / PB$

f. H (DB, DP, PB)

1.  $W = 0.622 * PVS(DP) / (PB - PVS(DP))$

2.  $H = 0.24 * DB + (1061 + 0.444 * DB) * W$

g. WB (H, PB)

1. If  $PB = 29.92$  and  $H > 0$

$$\text{Let } Y = \log(H)$$

$$\underline{\text{For } H < 11.758}$$

$$WB = 0.6040 + 3.4841 * Y + 1.3601 * (Y**2) + 0.9731 * (Y**3)$$

For H > 11.758

$$WB = 30.9185 - 39.682 * Y + 20.5841 * (Y**2) - 1.758 * (Y**3)$$

If PB  $\neq$  29.92, or H  $\leq$  0 solve the following equation by iterating WB

$$H = 0.24 * WB + (1061 + 0.444 * WB) * W(WB, WB, PB)$$

h. DP (PV)

1. Let Y = Log(PV)

If PV is less than 0.18036

$$DP = 71.98 + 24.873 * Y + 0.8927 * (Y**2)$$

Otherwise

$$DP = 79.047 + 20.579 * Y + 1.8893 * (Y**2)$$

Attached to this section are the Fortran listings of subroutines developed at the National Bureau of Standards which incorporate the psychrometric algorithms described above.

PVSF(X) corresponds to PVS (t)

DPF(PV) corresponds to DP (PV)

WBSF(H,PB) corresponds to WB (H, PB)

The routine entitled PSY1 generates dewpoint temperature, vapor pressure, humidity ratio, enthalpy, specific volume, and relative humidity when the dry-bulb temperature, wet-bulb temperature and the barometric pressure are provided as input. This subroutine essentially combines all the algorithms described in this section. PSY2 is similar to PSY1 except that the dewpoint temperature is given in lieu of the wet-bulb temperature.



SUBROUTINE PSY1(DB,WB,PR,DP,PV,W,H,V,RH)  
 THIS SUBROUTINE CALCULATES VAPOR PRESSURE(PV), HUMIDITY RATIO (W)  
 ENTHALPY(H), VOLUME(V), RELATIVE HUMIDITY(RH) AND DEW-POINT  
 TEMPERATURE WHEN THE DRY-BULB TEMPERATURE(DB), WET-BULB TEMPERATUR  
 (WB) AND BAROMETRIC PRESSURE(PB) ARE GIVEN

```

PVP=PVSF(WB)
IF(DB-WB)4,4,5
5 WSTAR=0.622*PVP/(PB-PVP)
IF(WB-32.)1,1,2
1 PV=PVP-5.704E-4*PB*(DB-WB)/1.8
GO TO 3
4 PV=PVP
GO TO 3
2 CDB=(DB-32.)/1.8
CWB=(WB-32.)/1.8
HL=597.31+0.4409*CDB-CWB
CH=0.2402+0.4409*WSTAR
EX=(WSTAR-CH*(CDB-CWB)/HL)/0.622
PV=PB*EX/(1.+EX)
3 W=0.622*PV/(PB-PV)
V=0.754*(DB+459.7)*(1+7000*W/4360)/PB
H=0.24*DB+(1061+0.444*DB)*W
DP=DPF(PV)
RH=PV/PVSF(DB)
RETURN
END

```

SUBROUTINE PSY2(DB,DP,PR,WB,PV,W,H,V,RH)  
 THIS SUBROUTINE CALCULATES THE FOLLOWINGS WHEN DRY-BULB TEMPERATURE  
 (DB), DEW-POINT TEMPERATURE(DP), AND BAROMETRIC PRESSURE(PB) ARE GIVEN  
 WB WET-BULB TEMPERATURE  
 W HUMIDITY RATIO  
 H ENTHALPY  
 V VOLUME  
 PV VAPOR PRESSURE  
 RH RELATIVE HUMIDITY

```

PV=PVSF(DP)
PVS=PVSF(DB)
RH=PV/PVS
W=0.622*PV/(PB-PV)
V=0.754*(DB+459.7)*(1+7000*W/4360)/PB
H=0.24*DB+(1061+0.444*DB)*W
WB=WB(F,H,PB)
RETURN
END

```

FUNCTION WBF(H,PB)

THIS PROGRAM APPROXIMATES THE WET-BULB TEMPERATURE WHEN  
ENTHALPY AND BAROMETRIC PRESSURE ARE GIVEN

```
IF (PB.NE.29.92) GO TO 2
Y=LOG(H)
IF (H.GT.11.758) GO TO 3
WBF=0.6041+3.4841*Y+1.3601*Y*Y+0.97307*Y*Y*Y
GO TO 4
3 WBF=30.9185-39.68200*Y+20.5841*Y*Y-1.758*Y*Y*Y
GO TO 4
2 WB1=150.
PV1=PVSF(WB1)
W1=0.622*PV1/(PR-PV1)
X1=0.24*WB1+(1061+0.444*WB1)*W1
Y1=H-X1
9 WB2=WB1-1
PV2=PVSF(WB2)
W2=0.622*PV2/(PR-PV2)
X2=0.24*WB2+(1061+0.444*WB2)*W2
Y2=H-X2
IF (Y1*Y2) 6,7,8
8 WB1=WB2
Y1=Y2
GO TO 9
7 IF (Y1) 10,11,10
11 WBF=WB1
GO TO 4
10 WBF=WB2
GO TO 4
6 Z=ABS(Y1/Y2)
WBF=(WB2*Z+WB1)/(1+Z)
4 RETURN
END
```

FUNCTION DPF(PV)

THIS SUBROUTINE CALCULATES DEW-POINT TEMPERATURE FOR GIVEN VAPOR PRESSURE

```
Y=LOG(PV)
IF (PV.GT.0.1836) GO TO 1
DPF=71.98+24.873*Y+0.8927*Y*Y
GO TO 2
1 DPF=79.047+30.579*Y+1.8893*Y*Y
2 RETURN
END
```

```

FUNCTION PVSF(X)
DIMENSION A(6)/-7.90298,5.02808,-1.3816E-7,11.344,8.1328E-3,-3.491
149/,B(4)/-9.09718,-3.56654,0.876793,0.0060273/,P(4)
T=(X+459.688)/1.8
IF(T.LT.,273.16) GO TO 3
Z=373.16/T
P(1)=A(1)*(Z-1)
P(2)=A(2)*LOG10(Z)
Z1=A(4)*(1-1/Z)
P(3)=A(3)*(10**Z1-1)
Z1=A(6)*(Z-1)
P(4)=A(5)*(10**Z1-1)
GO TO 4
3 Z=273.16/T
P(1)=B(1)*(Z-1)
P(2)=B(2)*LOG10(Z)
P(3)=B(3)*(1-1/Z)
P(4)=LOG10(B(4))
4 SUM=0
DO 5 I=1,4
5 SUM=SUM+P(I)
PVSF=29.921*10**SUM
RETURN
END

```

Table A-19

PR = 29.92 in. Hg.

DB	WB	DP	RH (%)	PV	w	H	V
80.0	80.0	80.0	100.0	1.0323	.02223	43.57	14.09
80.0	79.0	78.7	95.7	.9883	.02125	42.50	14.06
80.0	78.0	77.3	91.6	.9453	.02029	41.45	14.04
80.0	77.0	76.0	87.5	.9031	.01936	40.43	14.02
80.0	76.0	74.5	83.5	.8619	.01845	39.43	14.00
80.0	75.0	73.1	79.6	.8215	.01756	38.45	13.98
80.0	74.0	71.6	75.8	.7820	.01669	37.50	13.97
80.0	73.0	70.1	72.0	.7433	.01584	36.57	13.95
80.0	72.0	68.6	68.3	.7054	.01502	35.67	13.93
80.0	71.0	67.0	64.7	.6682	.01421	34.78	13.91
80.0	70.0	65.4	61.2	.6319	.01342	33.92	13.89
80.0	69.0	63.7	57.8	.5963	.01265	33.07	13.88
80.0	68.0	62.0	54.4	.5615	.01190	32.24	13.86
80.0	67.0	60.3	51.1	.5273	.01116	31.44	13.84
80.0	66.0	58.4	47.8	.4939	.01044	30.65	13.83
80.0	65.0	56.5	44.7	.4611	.00974	29.88	13.81
80.0	64.0	54.5	41.6	.4290	.00905	29.12	13.80
80.0	63.0	52.5	38.5	.3976	.00838	28.39	13.78
80.0	62.0	50.3	35.5	.3668	.00772	27.66	13.77
80.0	61.0	48.0	32.6	.3366	.00708	26.96	13.76
80.0	60.0	45.6	29.7	.3070	.00645	26.27	13.74
80.0	59.0	43.0	26.9	.2780	.00583	25.60	13.73
80.0	58.0	40.2	24.2	.2495	.00523	24.94	13.71
80.0	57.0	37.3	21.5	.2216	.00464	24.29	13.70
80.0	56.0	34.0	18.8	.1943	.00407	23.66	13.69
80.0	55.0	30.4	16.2	.1675	.00350	23.04	13.68
80.0	54.0	26.7	13.7	.1412	.00295	22.43	13.67
80.0	53.0	22.4	11.2	.1154	.00241	21.84	13.65
80.0	52.0	17.3	8.7	.0900	.00188	21.26	13.64
80.0	51.0	10.7	6.3	.0652	.00136	20.69	13.63
80.0	50.0	1.6	4.0	.0408	.00085	20.13	13.62
80.0	49.0	-14.6	1.6	.0169	.00035	19.59	13.61

Table A-20

Moist Air Properties Calculated by the  
Exact Goff-Gratch Method

PB = 29.92 in. Hg

DB	WB	DP	RH (%)	PV	W	H	S	V
80.0	80.0	80.0	100.0	1.0323	.02233	43.69	.0864	14.09
80.0	79.0	78.7	95.7	.9883	.02135	42.61	.0843	14.07
80.0	78.0	77.3	91.6	.9453	.02039	41.56	.0822	14.05
80.0	77.0	76.0	87.5	.9032	.01945	40.53	.0802	14.03
80.0	76.0	74.6	83.5	.8620	.01854	39.53	.0783	14.01
80.0	75.0	73.1	79.6	.8217	.01764	38.55	.0764	13.99
80.0	74.0	71.7	75.8	.7822	.01677	37.60	.0745	13.97
80.0	73.0	70.2	72.0	.7435	.01592	36.67	.0727	13.95
80.0	72.0	68.6	68.4	.7057	.01509	35.76	.0709	13.93
80.0	71.0	67.1	64.8	.6686	.01428	34.87	.0692	13.91
80.0	70.0	65.5	61.2	.6323	.01349	34.00	.0675	13.90
80.0	69.0	63.8	57.8	.5967	.01271	33.15	.0658	13.88
80.0	68.0	62.1	54.4	.5619	.01196	32.32	.0642	13.86
80.0	67.0	60.3	51.1	.5278	.01122	31.51	.0626	13.85
80.0	66.0	58.5	47.9	.4944	.01050	30.72	.0610	13.83
80.0	65.0	56.6	44.7	.4617	.00979	29.95	.0595	13.81
80.0	64.0	54.6	41.6	.4296	.00910	29.19	.0581	13.80
80.0	63.0	52.5	38.6	.3982	.00843	28.45	.0566	13.78
80.0	62.0	50.4	35.6	.3674	.00777	27.73	.0552	13.77
80.0	61.0	48.1	32.7	.3372	.00712	27.02	.0538	13.76
80.0	60.0	45.6	29.8	.3077	.00649	26.33	.0525	13.74
80.0	59.0	43.1	27.0	.2787	.00587	25.66	.0511	13.73
80.0	58.0	40.3	24.2	.2503	.00527	24.99	.0498	13.72
80.0	57.0	37.3	21.5	.2224	.00468	24.35	.0486	13.70
80.0	56.0	34.0	18.9	.1951	.00410	23.71	.0473	13.69
80.0	55.0	30.5	16.3	.1683	.00353	23.09	.0461	13.68
80.0	54.0	26.8	13.8	.1420	.00293	22.49	.0449	13.67
80.0	53.0	22.6	11.3	.1162	.00244	21.89	.0438	13.65
80.0	52.0	17.5	8.8	.0910	.00191	21.31	.0426	13.64
80.0	51.0	11.0	6.4	.0662	.00138	20.74	.0415	13.63
80.0	50.0	2.0	4.1	.0418	.00087	20.18	.0404	13.62

## References

1. Kimura, K., and Stephenson, D. G., "Solar Radiation on Cloudy Days", ASHRAE Transaction, pp. 227-233, Part I, 1969.
2. Mitalas, G. P., and Stephenson, D. G., "Absorption and Transmission of Thermal Radiation by Single and Double Glazed Windows", National Research Council of Canada Report 7104, December 1962.
3. Stephenson, D. G., "Tables of Solar Altitude, Azimuth, Intensity, and Heat Gain Factors for Latitudes from 43 to 55 Degrees North", National Research Council of Canada, Division of Building Research, Technical Paper No. 243, April 1967.
4. Groth, C. C., and Lokmanhekim, M., "Shadow - A New Technique for the Calculation of Shadow Shapes and Areas by Digital Computer", Second Hawaii International Conference on System Sciences, Honolulu, Hawaii, January 22-24, 1969.
5. Sun, Tseng-Yao, "Shadow Area Equations for Window Overhangs and Side Fins and Their Application in Computer Calculation", ASHRAE Semiannual meeting, Columbus, Ohio, February 5-8, 1968, Paper No. 2059.
6. Ito, N., and Kimura, K., "Convection Heat Transfer Coefficient at the Exterior Surface of Buildings Exposed to Natural Wind", (Japanese), Transaction of Japanese Society of Architectural Engineering, 1968.
7. Robinson, H. E. and F. J. Powell, "Thermal Resistance of Air Spaces and Fibrous Insulation Bounded by Reflective Surfaces", Building Material and Structures Report 151, National Bureau of Standards, 1957.



8. Stephenson, D. G., and Mitalas, G. P., "Calculation of Heat Conduction Transfer Functions for Multi-Layer Slabs", ASHRAE Transactions, Vol. 77, Part II, 1971.
9. Carslaw, H. S., and Jaeger, J. C., Conduction of Heat in Solids, Second Edition, 1959, page 326, Oxford at the Clarendon Press.
10. Mitalas, G. P. and J. G. Arseneault, "Fortran IV Program to Calculate Heat Flux Response Factors for Multi-layer Slabs, DBR Computer Program No. 23, National Research Council of Canada, 1967.
11. Kusuda, T., "Thermal Response Factors for Multi-layer Structures of Various Heat Conduction Systems", ASHRAE Transactions, pp. 250-269, Part I, 1969.
12. Høglund, B. I., Mitalas, G. P., and Stephenson, D. G., "Surface Temperatures and Heat Fluxes for Flat Roofs", Journal of Building Science, Vol. 2, No. 1, pp. 29-36, January 1967.
13. Stephenson, D. G. and Mitalas, G. P., "Cooling Load Calculations by Thermal Response Factor Method", ASHRAE Semiannual Meeting, Detroit, Michigan, January 20 - February 2, 1967, Paper No. 2018.
14. Mitalas, G. P. and Stephenson, D. G., "Room Thermal Response Factors", ASHRAE Transactions, P III 2.1 - 2.10, Part I, 1967.
15. Tamura, G., "Computer Analysis of Smoke Control with Building Air Handling Systems", ASHRAE Journal, pp. 46-54, August 1972.
16. Bailey, A., and Vincent, N. D. G., "Wind-Pressure on Buildings Including Effects of Adjacent Buildings", Journal, Institute of Civil Engineers, Vol. 20, No. 8, October, 1943.

17. Kusuda, T., "Algorithms for Psychrometric Calculations", Building Science Series 21, National Bureau of Standards, January 1970.
18. Tamura, G. T. and Wilson, A. G., "Building Pressures Caused by Chimney Action and Mechanical Ventilation", ASHRAE 74th Annual Meeting, Minneapolis, Minnesota, June 26-28, 1967, Paper No. 2047.
19. Brown, G., "Heat Transfer at Exterior Surfaces of Buildings", (Swedish), Transactions of National Swedish Coun. Building Res., Stockholm 27, 1956.
20. Brown, K. M., and Conte, S. D., "The Solution of Simultaneous Non-linear Equations", Proceedings of 22nd National Conference, Association for Computing Machinery, pp. 111-114, 1967.
21. Haurwitz, B., "Insolation in Relation to Cloudiness and Cloud Density", Journal of Meteorology, Vol. 9, No. 4, September 1946.
22. Kimura, K. and Stephenson, D. G., "Theoretical Study of Cooling Load Caused by Lights", ASHRAE Annual Meeting, Lake Placid, New York, June 24-26, 1968, Paper No. 2087.
23. Mitalas, G. P., "An Experimental Check on the Weighting Factor Method of Calculating Room Cooling Load", ASHRAE Transactions, 1969.
24. Mitalas, G. P., "Calculation of Transient Heat Flow Through Walls and Roofs", ASHRAE Annual Meeting, Lake Placid, New York, June 24-26, 1968, Paper No. 2086.
25. Sun, Tseng-Yao, "Computer Evaluation of the Shadow Area on a Window Cast by the Adjacent Building", prepared for submission as a paper in the future.
26. Threlkeld, J. L., "Thermal Environmental Engineering", Prentice Hall, 1970.



8. Appendix B

Weighting Factor Method of Calculating  
Heating and Cooling Loads and Space Temperature\*

---

\* This section was prepared by D. G. Stephenson and G. Mitalas of the National Research Council of Canada for the ASHRAE Task Group on Energy Requirements for Heating and Cooling.



The weighting factor method is based on the assumption that the heat transfer processes occurring in a room can be described by linear equations; and thus that the superposition principle can be used for the calculation of cooling load and space temperature. This means that the relationship between any excitation (e.g., power input to lights) and the corresponding component of the cooling load can be expressed in the form of a characteristic transfer function. Once all the transfer functions have been determined for a room, they can be used to calculate the response to any excitation. The weighting factors are a convenient way of representing these characteristic transfer functions for a room: they relate the Z-transforms of the excitations to the Z-transforms of the corresponding cooling load components.

### The Z-transform<sup>1, 2/</sup>

When a continuous signal,  $f(t)$ , is sampled at regular intervals of  $\Delta$ , the output of the sampling device is a train of pulses as shown in Figure B1. The Laplace transform of this output signal is

$$f(0) + f(\Delta)e^{-s\Delta} + f(2\Delta)e^{-2s\Delta} + \dots \quad (1)$$

If  $Z$  is substituted for  $e^{s\Delta}$ , the transform of the output from the sampler is

$$f(0) + f(\Delta)Z^{-1} + f(2\Delta)Z^{-2} + \dots \quad (2)$$

This polynomial in  $Z^{-1}$  is the Z-transform of the function  $f(t)$ . The chief advantage of this type of transform is that it can be obtained just by sampling the function at regular intervals: the successive outputs being the coefficients of successive powers of  $Z^{-1}$  in the Z-transform.



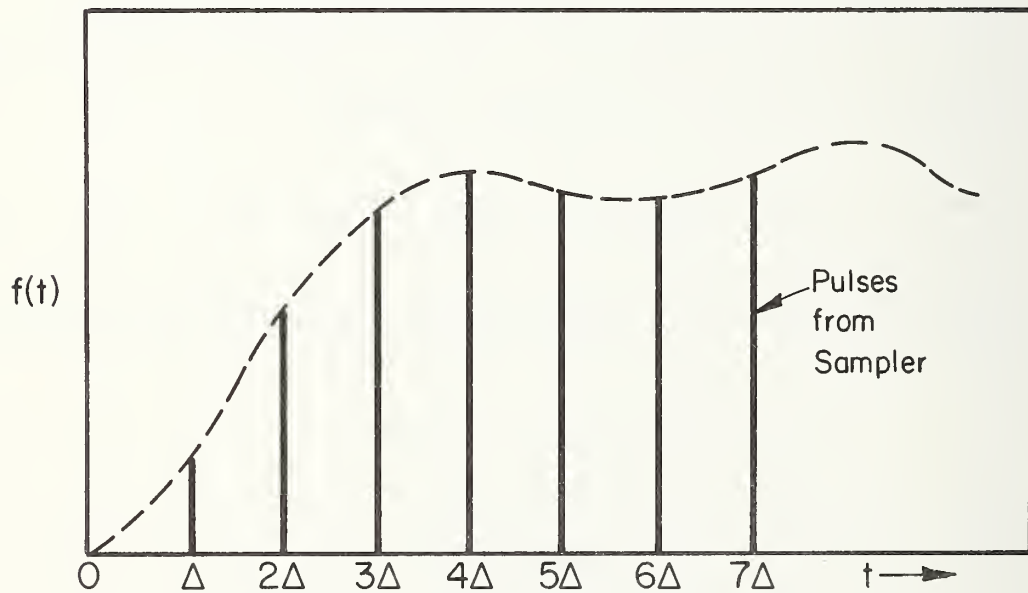
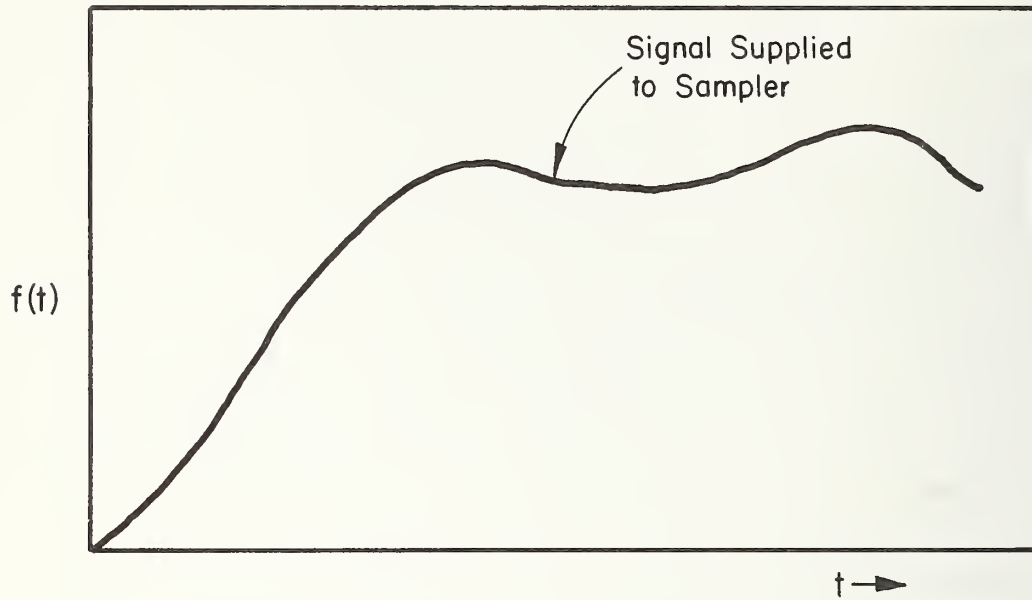

Figure B-1 Pulse Representation of a Continuous Function

If both the input and output of a system are expressed in terms of their Z-transforms, the ratio of the output/input is a Z-transfer function for the system. Assuming that such a transfer function,  $K(Z)$ , can be found, and that it can be expressed as the ratio of two polynomials in  $Z^{-1}$

$$\text{i.e.,} \quad K(Z) = \frac{a_0 + a_1 Z^{-1} + a_2 Z^{-2} + \dots}{b_0 + b_1 Z^{-1} + b_2 Z^{-2} + \dots} \quad (3)$$

it follows that  $O(Z)$ , the Z-transform of the output that results from an input represented by  $I(Z)$  is

$$O(Z) = K(Z) \cdot I(Z) \quad (4)$$

Both sides of this equation are polynomials so the coefficients of the various powers of  $Z^{-1}$  must be the same on the two sides of the equation.

Thus, equating the coefficients of  $Z^{-n}$  gives

$$O_n \cdot b_0 = I_n \cdot a_0 + I_{n-1} \cdot a_1 + I_{n-2} \cdot a_2 + \dots \\ - \{O_{n-1} \cdot b_1 + O_{n-2} \cdot b_2 + \dots\} \quad (5)$$

where the subscript  $n$  on  $O$  and  $I$  indicates the value of the function at  $t = n\Delta$ , i.e.,  $O_n$  is the coefficient of  $Z^{-n}$  in the Z-transform  $O(Z)$ . This expression relates the output at any time  $t = n\Delta$  to the input at that time and the values of the input and output at earlier times. The coefficients  $a_0, a_1, \dots$  and  $b_0, b_1, \dots$ , contain all the characteristics of the system.

## Cooling Load, Heat Extraction and Room Temperature

Using the Z-transfer functions approach, the cooling load is the output that results from the input, which is the heat gain. The weighting factor sets are the transfer functions relating the cooling loads to heat gains. The procedure for calculating cooling load is, therefore, first to calculate the various components of the heat gain, and then to combine them with the appropriate weighting factor sets to obtain the cooling load. An expression like equation (5) is used to compute each component of the cooling load.

The cooling load of a space depends on both the magnitude and the nature of its excitations (i.e., outside air temperature, direct and diffuse solar radiation, electric energy input to lights, etc.). The resulting cooling load also depends on the location of the element that absorbs the energy of the excitation. For example, the cooling load profile resulting from one unit of solar radiation absorbed by the window glass is quite different from that of one unit of solar radiation absorbed by the floor surface. To shorten the computation of cooling load, the heat gain must be subdivided into a limited number of components. For example, the total heat gain by a space can be represented by the following components:

- (1) Heat gain through window. (HEATG and HEATG<sup>1</sup>)
- (2) Heat gain through exterior walls and roofs. (HEATX)
- (3) Total power input to lights. (HEATIS)
- (4) Heat gain through doors, partitions, underground walls and floors, and due to internal heat sources other than lights. (HEATDP)

(5) Sensible heat gain due to infiltration. (HEATVS)

Each of these heat gain components is calculated on the basis of a constant air temperature in the space. The actual air temperature generally deviates from this reference value, and consequently the rate of heat extraction from the space, HE, differs from the cooling load. The calculation of actual room air temperature and heat extraction rate is the final step in the sequence of calculation: in this case, the previously calculated cooling load is the input along with the characteristics of the air conditioning unit; and heat extraction rate and air temperature are the outputs. If this transfer function is expressed in the form

$$\frac{HE - CL}{\delta} = \sum_0^v x_j z^{-j}/1 + \sum_1^w y_j z^{-j},$$

or

$$HE_n = CL_n + \sum_0^v x_j * \delta_{n-j} - \sum_1^w y_j * (HE_{n-j} - CL_{n-j}) \quad (6)$$

where  $\delta$  is the deviation of actual air temperature from the reference value used to calculate the heat gains.

The heat extraction rate given by equation (6) must match the rate given by the characteristic of the air conditioning unit. For example, a cooling unit with a simple proportional control system has a characteristic of the form

$$HE_n = C + D * \delta_n \quad (7)$$

where

C = heat extraction rate of the unit operating in a room  
at the reference temperature

D = change in the rate of heat extraction caused by one degree rise in room air temperature

Equations (6) and (7) can be combined to give an explicit expression for  $\delta_n$

$$\delta_n = \frac{CL_n - C + \sum_1^v x_j * \delta_{n-j} - \sum_1^w y_j * (HE_{n-j} - CL_{n-j})}{D - x_0} \quad (8)$$

and then equation (7) can be used to evaluate  $HE_n$ .

Equation (8) can be used to calculate  $\delta_n$  even if the cooling equipment is off: when the equipment is not operating, C and D are both zero.

#### Calculation of Room Weighting Factors

The calculation of the room weighting factors is based on the solution of a set of heat balance equations for all the room air<sup>3, 4/</sup> (RMTMP). A computer program for evaluating weighting factors has been developed by the National Research Council of Canada<sup>5/</sup>, based on the procedure given in Reference 4.

Three different groups of room weighting factor sets are computed by this program:

- (1) The first group is very large, consisting of a set of factors for each excitation at each surface.
- (2) The second group combines all of the sets in group 1 that pertain to diffuse solar radiation into a single set; it combines all of the sets for direct solar radiation incident on the room surfaces other than inside window pane, floor, and furniture into another combined set; and lastly, it combines all the sets that



pertain to excitation by the power supplied to the lights into a single set.

- (3) The third group of factors carry the consolidation of the various sets of the limit: there is just one set of factors for each component of heat gain.

It is not intended that the first group should be used directly for room cooling or heating load calculations, as the second group give essentially the same results with considerably less computation<sup>6/</sup>. The further simplification provided by the use of the third group require that the following assumptions be made:

- (1) That the heat gain through room envelope components can be calculated with sufficient accuracy using combined inside surface heat transfer coefficient and that the room weighting factors are the same for heat gain through window, opaque outside wall, corridor wall and a roof.
- (2) That the fraction of the solar radiation absorbed by the window glass and shade, and transmitted directly into the room as well as the portions absorbed by various room surfaces and furniture are constant during the day.

It is probable that the first assumption will not introduce significant errors; however, the second assumption is questionable. At this time, research information is lacking to establish the possible magnitude of the error introduced by this assumption.



The procedures given in this report to convert room excitation to cooling load and heat extraction are based on the third group of room weighting factors, i.e., RMRG, RMRX, RMRT and RMRTS. In addition, simplified procedures are given for the calculation of the RMRT and RMRTS sets. If the highest possible precision is important, weighting factors in the second group should be used.

### References

- (1) T. R. Ragazzini and G. F. Franklin, "Sampled-Data Control Systems", McGraw-Hill Book Company, Inc., 1958.
- (2) E. I. Jury, "Theory and Application of the Z-transform Method", Wiley, 1964.
- (3) D. G. Stephenson and G. P. Mitalas, "Cooling Load Calculations by Thermal Response Factor Method", ASHRAE Transactions, Vol. 73, Part 1, 1967.
- (4) G. P. Mitalas and D. G. Stephenson, "Room Thermal Response Factors", ASHRAE Transactions, Vol. 33, Part 1, 1967.
- (5) G. P. Mitalas and J. G. Arseneault, "Fortran IV Program to Calculate Weighting Factors for a Room".
- (6) G. P. Mitalas, "An Experimental Check on the Weighting Factor Method of Calculating Room Cooling Load", presented at ASHRAE Denver Meeting, 1969.
- (7) G. P. Mitalas, "Calculations of Transient Heat Flow Through Walls and Roofs, ASHRAE Transactions, Vol. 74, Part II, 1968.

- (8) D. G. Stephenson and G. P. Mitalas, "Transient Heat Conduction Through Walls and Roofs, prepared for submission to the International Journal of Heat and Mass Transfer.
- (9) T. Kusuda, "Thermal Response Factors for Multi-layer Structures of Various Heat Conduction Systems", presented at ASHRAE Chicago Meeting, 1969.
- (10) G. P. Mitalas and J. G. Arseneault, "Fortran IV Program to Calculate Heat Flux Response Factors for Multi-layer Slabs, DBR Computer Program No. 23, National Research Council of Canada, 1967.



9. Appendix C

NBSLD Data Forms



## NBSLD in a Time-Sharing System

Recently, the General Services Administration of the federal government has subscribed to a time-sharing system called INFONET, which has in turn made the use of NBSLD practical on a time-sharing system (see figure on page 3c).

Entire subroutines and several main programs, which are parts of NBSLD, have all been placed into INFONET and are now accessible to the various government agencies through teletype terminals.

Some of the attractive features of the INFONET system are:

1. Data files for input and output can be created separately from the execution of a main program such that computer time does not have to be sacrificed by the slowness of handling these data. (This is a common problem for heating/cooling load calculation programs.) An input data file can be created, edited and stored for use by a main program, while an output file of intermediate and detailed results can be created in mass storage for later inspection without prolonging the computation time. When a final output is questionable, the analyst can examine the input as well as the intermediate output in detail simply by calling these data files independently.
2. After the execution of a program, the analyst can call for specific values of variables without adding special instructions in the main program to type out these variables.



3. The editing of a program as well as the data files can be made in such a manner that the deletion, addition, or alteration of statements or lines can be made without retyping the entire line.
4. All sub-programs are independently filed, compiled and available to any main program in the same library by an elaborate linking routine. Psychrometric routines, solar heat gain routines, transient heat conduction routines and weather data decoding routines can thus be used by many different main programs.

This time-sharing system is therefore very well suited for design calculations where many different alternatives for building construction such as the area of glass, shading of the windows and thermal mass of the internal structures are to be evaluated as to how they affect heating/cooling loads or energy requirements.

# NBSLD on INFONET

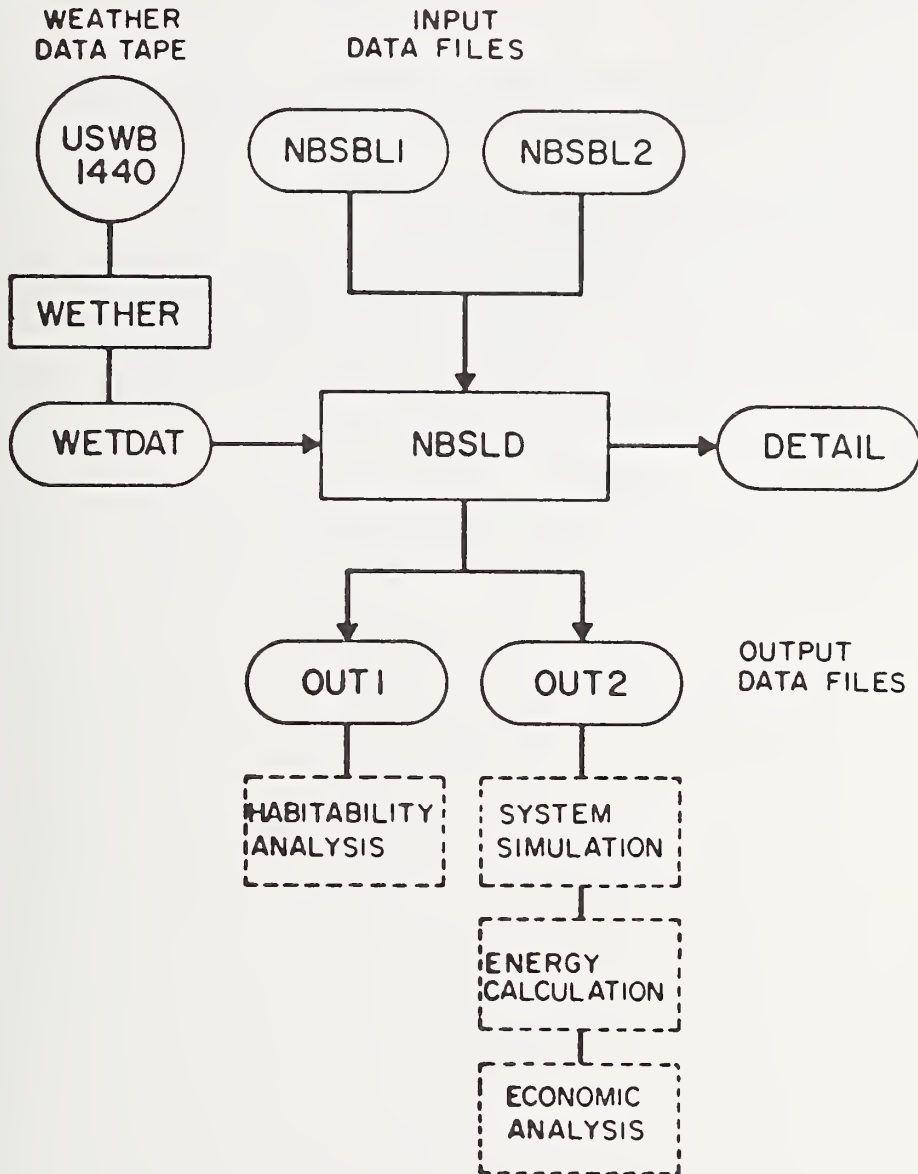

A copy of the NBSLD subroutines and main program may be obtained through the INFONET system as follows:

```
!U$TDEF,SAVE_△RT0105      (△: space)
```

```
!DEVICES,QUEUE_△1
```

(Wait for allocation if REQUEST QUEUED by periodically typing

```
!DEVICES)
```

```
!COPY,IN,EVERY_△RT0105_△-PNC,-REL,-XQT
```

RT0105 is the transportable tape containing all the subroutines and the NBSLD main program, sample data, and sample output.

Sample data file: NBSBL1

Output file: RESULT

The tape also contains the weather decoding routines.

## Introduction

This manual contains the input data forms with instructions for preparing data needed to perform heating and cooling load calculations using NBSLD.

In addition, the manual contains engineering data needed for the computations so that the use of other handbooks or references are generally unnecessary. The required numerical data are to be filled into blank spaces provided on each DATA SHEET and then each sheet can be used directly at a computer terminal or to produce a data card if the program is being run in "batch mode" at a central facility.

## General Instruction

Figure C-1 shows the flow diagram or sequence for the data preparation.

Schedule Profile data sheets A, B, C and D are prepared for a building and are assumed the same for all zones or rooms within the building.

DATA SHEETS 1 through 3 are prepared for each different building, thus need not be repeated for the analysis of rooms within the same building.

DATA SHEETS 6 and 7 usually need to be prepared only for the first room of the building, because other rooms that follow in the same building usually employ the same wall, roof, and floor constructions.

When two rooms have identical shape and construction and differ only in orientation, the second room is considered to be rotated with respect to the first room and requires only DATA SHEETS 4 and 5.

# DATA SHEET PREPARATION GUIDE

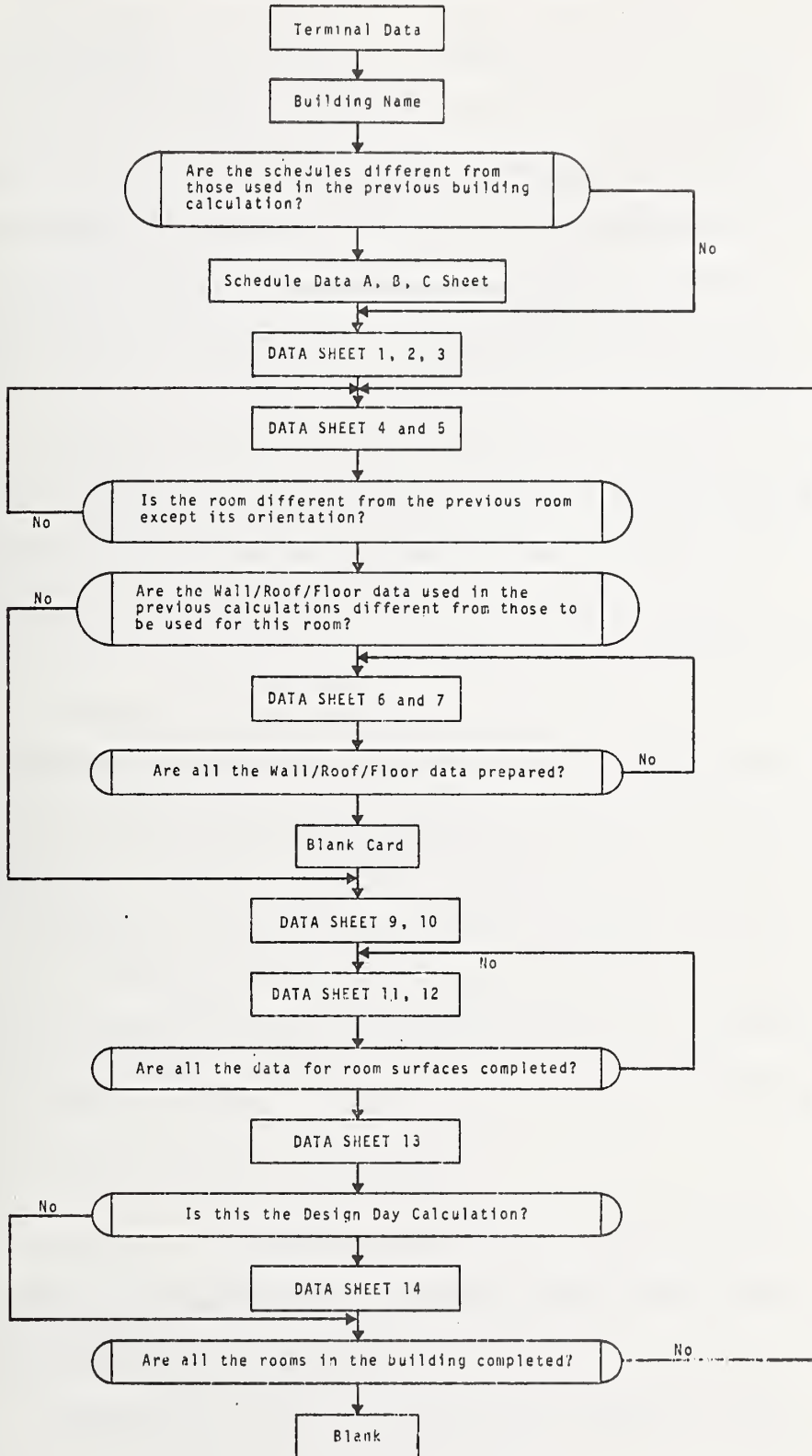



## Operational Data

**RUNID:** Index for the calculation of Conduction Transfer Functions:  
RUNID = 1 if the load calculation being made for this particular run requires the generation of Conduction Transfer Functions for the walls, roof, ceilings and floors in the building. The Conduction Transfer Functions generated during the run will be stored in tape unit 8 for the future rerun.

RUNID = 2 if the Conduction Transfer Functions have already been calculated and stored in tape unit 8 and this particular run does not require the generation of new Conduction Transfer Functions.

**RUNTYP:** Index for the types of calculations to be performed:

RUNTYP = 1 if the calculation is for the hour by hour determination of heating and cooling load for a specified period by making use of weather data tape (unit 7).

RUNTYP = 2 if the calculation is for the design heating and cooling load. A weather data tape is not required for this run.

**ASHRAE:** Index for the weighting factor usage:

ASHRAE = 0 if the Weighting Factor Method of the ASHRAE Task Group is replaced by a more exact calculation procedure developed at the National Bureau of Standards.

ASHRAE = 1 if the Weighting Factor Method of the ASHRAE Task Group is used to convert the heat gains and losses to loads. (incomplete)

**IDETAL:** Index for the output specification:

IDETAL = 0 if output of the run is only the daily maximum and the daily total heating and cooling loads.

IDETAL = 1, output of the run will display input data and details of intermediate results such as Conduction Transfer Functions, Radiation heat exchange factors, solar radiation and solar heat gain.

**METHOD:** Index for the treatment of room surface radiation heat exchange calculation:

METHOD = 0 if the radiation exchange among the room surfaces are treated individually on room by room basis.

METHOD = 1 if a building zone is treated as a box and all the interior partition walls and floor/ceiling sandwich constructions are treated as a single slab to be distributed uniformly on the floor of the box as an extra layer for that floor. (incomplete)

**RFMTAP:** Tape drive unit number for the tape to be used by the system simulation program of Ross F. Meriwether. If no tape is needed, RFMTAP = 0.

(integer variables)

RUNID	RUNTYP	ASHRAE	IDETAL	METHOD	RFMTAP

Building Name

NAMEBD

Identification of the job, name of the building, address or other pertinent information may be used within the limit of 34 alphabetical/numerical characters.

NAMEBD

1	2	3	4	5	6	7	8	9	10	11	12	13	14	15	16	17	18	19	20	21	22	23	24	25	26	27	28	29	30	31	32	33	64	65	66	67	68	69	70	71	72							
X	X																																															

Start from Column 3

(Alphanumeric data)

Schedule Profile-A

QLITX: Normalized\* daily schedule (24-hour profile) or power input for lighting during the weekdays.

QEQUX: Normalized\* daily schedule (24-hour profile) of power input for electrical appliances and other equipment (other than those involved for heating/cooling equipment) during the weekdays.

QOCUP: Normalized\* daily schedule (24-hour profile) of occupancy (number of adults) during the weekdays.

QLITX

QEQUX

\* Having a value between 0 and 1.





Schedule Profile-B\*

QLITX', QEQUX', QOCUP' are the same as QLITX, QEQUX and QOCUP respectively except that these data are for the weekends.

QLITX'

QEQUX'

QOCUP'

\* These data should be all zero for the design day calculation.

Schedule Profile-C\*

QLITX", QEQUX", QOCUP" are the same as QLITX, QEQUX, and QOCUP respectively except that these data are for the holidays.

QLITX"

QEQUX"

QOCUP"

\* These data should be all zero for the design day calculations.

## Schedule Profile-D

### Room Temperature and Humidity Schedule

RMDBS: 24 hour profile of room thermostat setting during the occupied cooling day, °F.

RMDBW: 24 hour profile of room thermostat setting during the occupied heating day, °F.

RMDBWO: Lower limit on room thermostat setting during the unoccupied heating day, °F. (See Figure C4 in Data Sheet 11.)

RMDBSO: Upper limit on room thermostat setting during the unoccupied cooling day, °F. (See Figure C4 in Data Sheet 11.)

RHW: Lower limit on room relative humidity setting during the heating days, %.

RHS: Upper limit on room relative humidity setting during the cooling days, %.



Data Sheet 1\*

NDAY: Number of days for which the calculations are to be performed.

NSKIP: Number of days to be skipped in case the computation does not start from the first day of the weather tape, which is usually 00 hour, of January 1 if standard NCC 1440 tape is used.

TAPE 2: Tape unit or file number for the output tape, if 0 an output tape or file is not produced. The output tape or file contains the hourly load and weather data needed for the system simulation.

NDAY	NSKIP	TAPE 2							

(integer data)

\* For the design calculation or when RUNTYP is 2, all three variables listed here can be input as 0.

Data Sheet 2\*

Month: Month for which the calculation is to be done.

Day: Day of the month on which the calculation is to be done.

ELAPS: Number of days elapsed from January 1 to reach the design day. For example, it is 201 for July 21 of a non-leap year.

DBMAX: Maximum outdoor temperature of the design day for cooling (see Table C1 which has been taken from the 1972 ASHRAE Handbook of Fundamentals).

RANGE: Daily range of the outdoor temperature during the design day, °F, (see Table C1).

WBMAX: Summer design wet-bulb temperature, °F, (see Table C1).

DBMWT: Design outdoor air temperature for the heating load calculation, °F, (see Table C1).

TGS: Summer design ground temperature, °F, (see Table C1).

TGW: Winter design ground temperature, °F, (see Table C1).

\* If a weather tape is being used and a conventional design calculation is not being done, all variables listed here can be input as 0 except TGS, TGW and UG.



UG: Ground heat transfer coefficient for design heating load calculations based upon Chapter 21, 1972 ASHRAE Handbook of Fundamentals, Btuh\*, (use 0.1 if uncertain).

MONTH	DAY	ELAPS	DBMAX	RANGE	WBMAX	DBMWT	TGS	TGW	UG

\* Btuh = Btu per (hr) (sq. ft.) (°F).

Data Sheet 3

LONG: Longitude of the building location, degrees.

LAT: Latitude of the building location, degrees (see Table C1).

TZN: Time zone number:

- 5 Eastern Standard time zone.
- 6 Central Standard time zone.
- 7 Mountain Standard time zone.
- 8 Pacific Standard time zone.

ZLF: Building exterior wall perimeter, ft.\*

RHOW: Outdoor air relative humidity for a design heating load calculation, %.

(real variable)

LONG	LAT	TZN	ZLF	RHOW					

\* For interior space, use the perimeter bounded by non-air conditioned spaces.

The value of ZLF is needed only when ASHRAE = 1. If the value is unknown use ZLF = 10. For the case ASHRAE = 0 use ZLF = 0.

Data Sheet 4

NAMERM

After this card, the data that follow will refer to this specific room or space in the building.

NAME OF THE ROOM																																										
1	2	3	4	5	6	7	8	9	10	11	12	13	14	15	16	17	18	19	20	21	22	23	24	25	26	27	28	29	30	31	32	33	34	35	36	37	38	39	40	41	42	
X	X																																									

Start from Column 3

(Alphanumeric data; 34 columns maximum)

Data Sheet 5

IROT: Room rotation index:

= 0: if the room load is to be calculated without reference to any previously described room.

= number of degrees: if this room is to be the same as the previous room except for rotation clockwise a specified number of integer degrees.

ISKIP: Wall/Roof/Floor construction data skip:

= 0: if the room requires a new set of wall/roof/floor construction data.

= 1: if the wall/roof/floor data used by the previous room is reused for this room. If ISKIP = 1, data sheets 6 and 7 should be omitted.

INCLUD: Space load summation index:

= 1: space load not included in the summation.

= 0: space load included in a summation of the space load of the previous room.

(integer variables)

IROT	ISKIP	INCLUD							

Data Sheet 6

Wall/Roof/Floor-A

N: Number of layers of composition in a given wall/roof/floor construction.

By referring to the data of Table C3 (taken from the 1972 ASHRAE Handbook of Fundamentals), give the following information for each of the layers starting from the innermost layer to the Nth layer, which is the outermost layer.

L: Thickness of the layer, ft.

K: Thermal conductivity of the layer, Btuh per (hr) (ft) ( $^{\circ}$ F).

P: Density of the layer material, lb per cu. ft.

C: Specific heat of the layer material, Btu per (lb) ( $^{\circ}$ F).

R: Thermal resistance value of the layer in (hr) (sq. ft.) ( $^{\circ}$ F) per Btu.

For the calculation where the ASHRAE weighting factor method is used (ASHRAE = 1), the innermost layer is always the inside surface thermal resistance. If ASHRAE = 0, omit the inside surface thermal resistance. Outside surface thermal resistance is never used in all cases.

The value of R is to be given only when the layer has no apparent thermal mass. If the value of L, K, P, and C are given, R should be zero. If R is given, L, K, P, and C should all be zero, in particular, L should be zero even if it is physically non-zero. For the ground floor, add a finite thickness slab consisting of a 12" thick earth layer.

- Note: (1) At least one of the N layers should have non-zero values of L, K, P, and C.
- (2) If two or more consecutive layers have no thermal mass, their thermal resistance values should be combined.
- (3) If a particular wall is considered to have no appreciable thermal mass, or if it is desired not to consider the thermal mass effect, data for this particular wall should not be included in the data sheets.
- (4) If roof is over attic space the innermost (first) layer should be inside thermal resistance in all cases.

IRF\*  
1

(integer)

N									
---	--	--	--	--	--	--	--	--	--

(real number)

L	K	P	C	R	
					1st LAYER - innermost
					2nd LAYER
					3rd LAYER
					4th LAYER
					Nth LAYER

\* IRF is not the input data in this data sheet. It is the identifier of the particular wall in the sheet.

























ROOMNO: Room identification number.

QLITY: Maximum lighting power input to the room, expressed as watts per sq. ft. of floor area (see Table C4).

QEQPX: Maximum electric power input for the appliances and other equipment in the room exclusive of the heating and air conditioning equipment, expressed as watts per sq. ft. of floor area (see Table C4).

QCU: Maximum number of adult occupants in the room during the day (count a child as 0.5).

FLCG: Fraction of electric power for lighting which can be assumed to go directly to the return air.

FRAS: Fraction of internal heat gains which can be assumed to be absorbed by the room surfaces instantaneously (as a result of radiation).

TS: Upper temperature limit on outdoor air which can be brought in during the occupied period to reduce the cooling load (NVENT = 1). (See Data Sheet 16.)

CFMS: Flow rate of outdoor air introduced for natural cooling purposes, cu. ft. per minute, when ambient temperature is less than TS (NVENT = 1). This data should be zero when RUNTYP (page 8c) = 1. (See Data Sheet 16.)

ARCHGS: Infiltration in terms of number of air changes per hour during the summer\* months.

ARCHGW: Infiltration in terms of number of air changes per hour during the winter\*\* months.

ARCHGM: Minimum infiltration in terms of air changes per hour when ARCHGS = 0 and ARCHGW = 0.

ZNORM: Number of rooms of the same type being described in the building.

\* June through September.

\*\* October through May.

ROOMNO	QLITY	QEQPX	QCU	FLCG	FRAS	TS	CFMS	ARCHGS	ARCHGW
ARCHGM	ZNORM								

IW: Building weight index:

IW = 1 Heavy structure (approximately 70 lb per sq. ft. of floor use or above).

IW = 2 Medium weight structure (between 30 and 70 lb per sq. ft. of floor area).

IW = 3 Lightweight structure (below 30 lb per sq. ft. of floor area).

IL: Lighting fixture index.

ISTART: Starting hour of occupancy.

ILEAVE: Ending hour of occupancy.





Data Sheet 10

Temperature Control Data

TUL: Upper limit of thermostat, above which the room requires cooling, °F, during occupied period.

TLL: Lower limit of thermostat, below which the room requires heating, °F, during occupied period.

QCMAX: Maximum sensible cooling capacity of the room air supply system, Btu per hour (for the design load calculation this data should be sufficiently large so that it will not be exceeded by the peak cooling load ... non-negative value when ITHST = 0 and ITK = 0 on Sheet 11).

QHMAX: Maximum sensible heating capacity of the room air supply system, Btu per hour (for the design load calculation this data should be sufficiently large so that it will not be exceeded by the peak heating load ... non-negative value when ITHST = 0 and ITK = 0 on Sheet 11).

DBVMAX: Maximum outdoor temperature when the natural cooling by ventilation is used.

DBVMIN: Minimum outdoor temperature, below which the natural cooling cycle is disengaged.

TUL	TLL	QC MAX	QH MAX	DBV MAX	DBV MIN				

Temperature Control Indices, ITHST and ITK

ITHST = 1, ITK = 0: The hourly profile of room temperature, either constant or night setback, is prescribed ...

Figure C2.

ITHST = 0, ITK = 1: The room temperature is to be calculated for the room which is neither heated nor cooled

... Figure C3.

ITHST = 1, ITK = 1: The upper and lower limit of the room temperature are given. The room will be heated if the room temperature falls below the lower limit TLL and the room is cooled if the room temperature rises above the upper limit TUL.

As long as the room temperature is between these two limits, the room is neither heated nor cooled ... Figure C4.

ITHST = 0, ITK = 0: The same as above except that the maximum capacities of heating and cooling systems are introduced. If the room heating and cooling loads exceed the system heating and cooling capacities respectively, the room temperature drift from the set points TLL and TUL is calculated ... Figure C5.

ITHST	ITK								

(1) CONSTANT TEMPERATURE MODE  
(ITHST=1)  
ITK=0

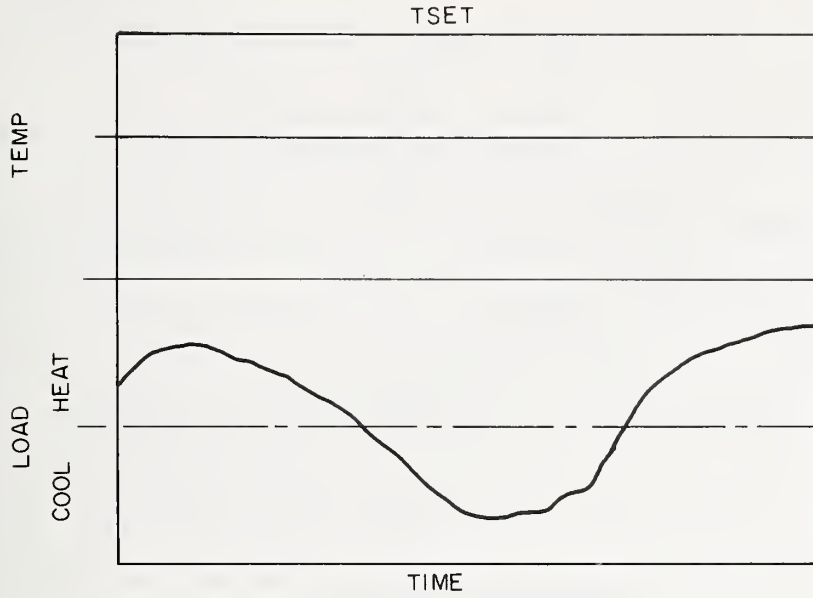

Figure C2

(2) FLOATING TEMPERATURE MODE  
(ITHST=0)  
ITK=1

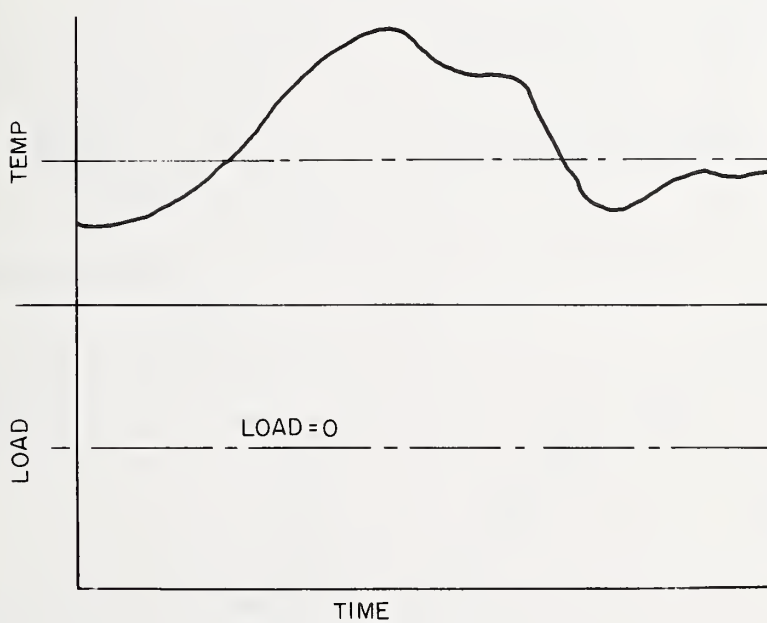
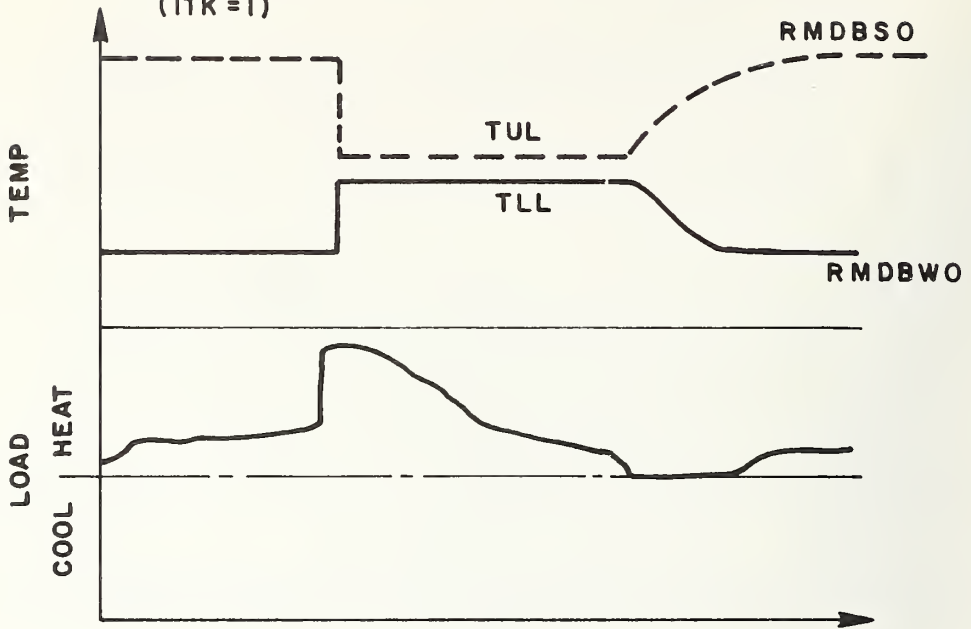

Figure C3



(3) PRESCRIBE TEMPERATURE LIMIT MODE  
(ITHST = 1)  
(ITK = 1)



(4) CONTROL SIMULATION MODE  
(ITHST = 0)  
(ITK = 0)

Figure C4

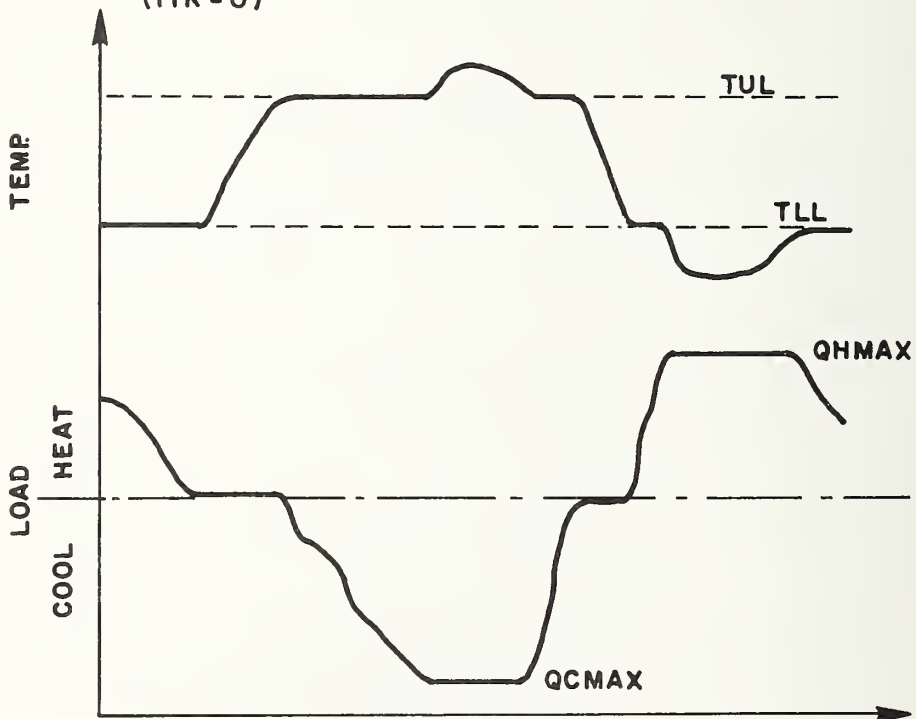

Figure C5

Data Sheet 12

NS: Number of different type heat transfer surfaces in the south wall.

NW: Number of different type heat transfer surfaces in the west wall.

NN: Number of different type heat transfer surfaces in the north wall.

NE: Number of different type heat transfer surfaces in the east wall.

L: Length of the room along the south wall, ft.

W: Width of the room along the west wall, ft.

H: Height of the room ft.

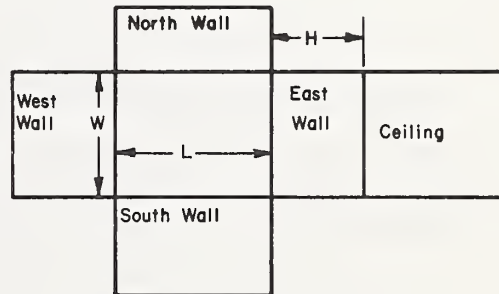
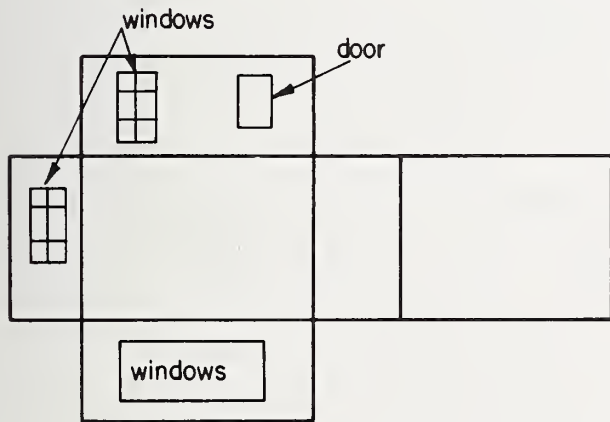

Note: Number of heat transfer surfaces should not exceed 1 for the ceiling and for the floor.

(integers)\*

NS	NW	NN	NE						
L	W	H							

(real values)

\*  $NS + NW + NN + NE$  should not exceed 28.

ITYPE : Exposure surface type index:

- = 1 if roof.
- = 2 if exterior wall.
- = 3 if window or glass door.
- = 4 if door.
- = 5 if floor on ground or basement wall.
- = 6 if partition walls, party walls, floor/ceiling, furnishings and other internal mass.
- = 7 if completely open.
- = 8 if the adjacent space is not air conditioned and will be considered as having a temperature the same as the outdoors.

IRF: Roof/wall/floor construction identifier index shown in the upper right corner of the roof/wall/floor data sheet 6. If not applicable (such as the cases for lightweight walls, doors and windows), which are not specified in data sheets 6 and 7. IRF = 10.

A: Area of the surface, sq. ft.

AZW: Surface orientation angle, degrees clockwise from south:

- 0 for south facing surface, roof/ceiling or floor.
- 45 for southwest facing surface.

\* See note on data sheet 14.

90 for west facing surface.  
135 for northwest facing surface.  
180 for north facing surface.  
-135 for northeast facing surface.  
-90 for east facing surface.

U: Overall heat transfer coefficient of a surface (Btuh) for which the data for roof/wall/floor are not provided (IRF = 10). For the surface for which roof/wall/floor data are provided (IRF  $\neq$  10), U should be zero because it will be computed in the program.

SHADE: Shading coefficient for the ITYPE = 3 surface (window or glass door) (see Table C5 which has been taken from the 1972 ASHRAE Handbook of Fundamentals). For all other types of surfaces, this parameter should be zero.

ABSP: Solar absorption coefficient for the exterior surface (see Table C6 which has been taken from Thermal Radiation Properties Survey, G. G. Gubareff, J. E. Jansen, and R. H. Torborg, Honeywell Research Center, 1960). This value should be zero for the surfaces of ITYPE = 3, 5, 6 and 7, and 8.

SHDW: Shadow parameter = 1 if completely shaded by an adjacent building or an external shading device; = 0 if otherwise.

integer

real variable

ITYPE	IRF	A	AZW	U	SHADE	ABSP	SHD		



(Exterior Shading Device Data)

Data are given in ft. and as dictated by the figure below.

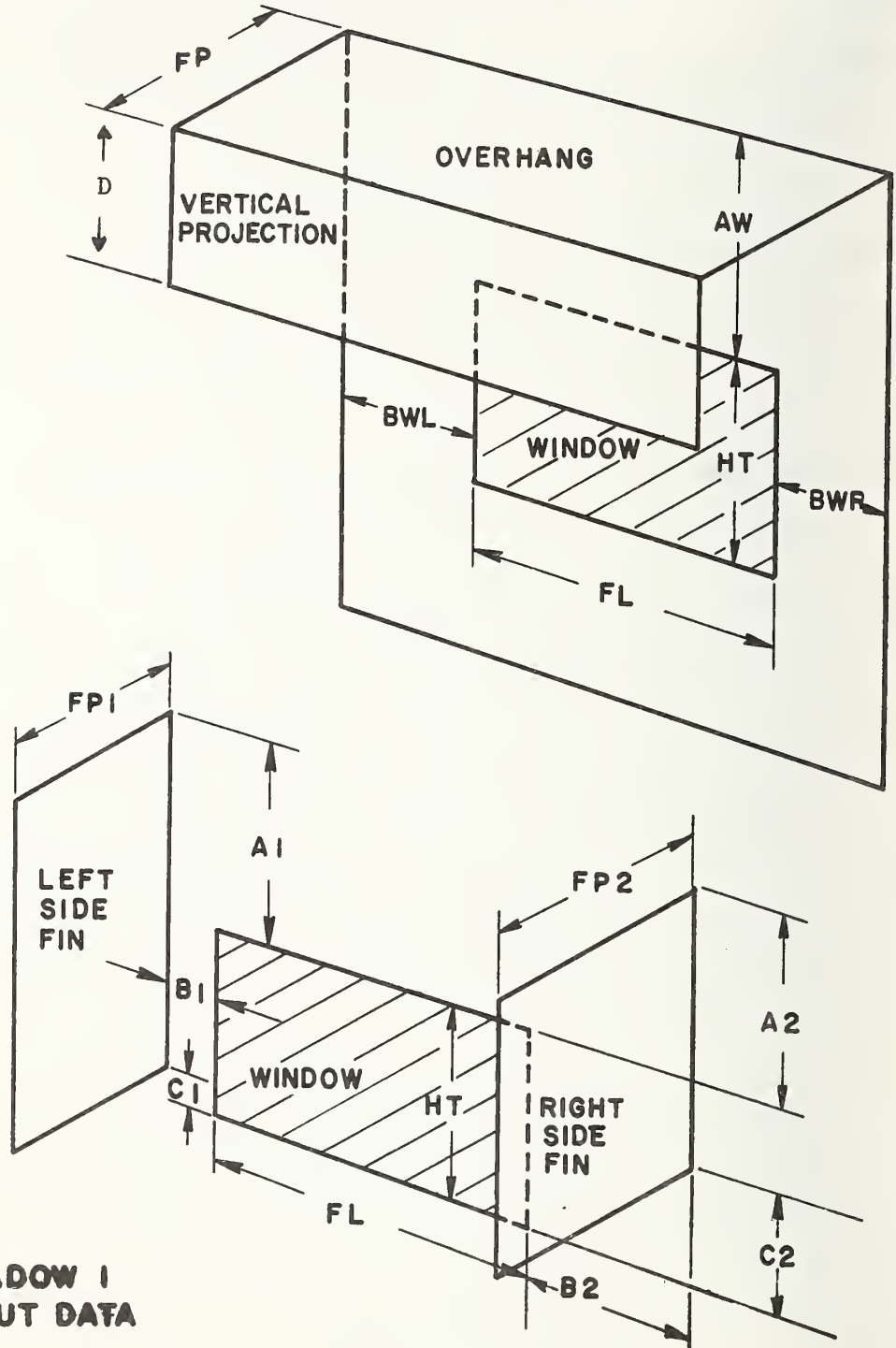

**SHADOW I  
INPUT DATA**

FL	HT	FP	AW	BWL	BWR	D			

FPI	AI	BI	CI	FP2	A2	B2	C2		

\* The sequence of input should be roof/ceiling, south facing surfaces, west facing surfaces, north facing surfaces, east facing surfaces and floor. While each vertical exposure can accommodate more than one type of surface such as wall, door and window, only one surface should be given for floor and roof/ceiling.

Data Sheets 13 and 14 are to be repeated for each of all the surfaces of the room.

Repetition of Data Sheets 13 and 14

ITYPE	IRF	A	AZW	U	SHADE	ABSP	SHDW		

FL	HT	FP	AW	BWL	BWR	D			

FPI	AI	BI	CI	FP2	A2	B2	C2		

ITYPE	IRF	A	AZW	U	SHADE	ABSP	SHDW		

FL	HT	FP	AW	BWL	BWR	D			

FPI	AI	BI	CI	FP2	A2	B2	C2		

ITYPE	IRF	A	AZW	U	SHADE	ABSP	SHDW		

FL	HT	FP	AW	BWL	BWR	D			

FPI	AI	BI	CI	FP2	A2	B2	C2		

Repetition of Data Sheets 13 and 14

ITYPE	IRF	A	AZW	U	SHADE	ABSP	SHDW		

FL	HT	FP	AW	BWL	BWR	D			

FPI	AI	BI	CI	FP2	A2	B2	C2		

ITYPE	IRF	A	AZW	U	SHADE	ABSP	SHDW		

FL	HT	FP	AW	BWL	BWR	D			

FPI	AI	BI	CI	FP2	A2	B2	C2		

ITYPE	IRF	A	AZW	U	SHADE	ABSP	SHDW		

FL	HT	FP	AW	BWL	BWR	D			

FPI	AI	BI	CI	FP2	A2	B2	C2		

Repetition of Data Sheets 13 and 14

ITYPE	IRF	A	AZW	U	SHADE	ABSP	SHDW		

FL	HT	FP	AW	BWL	BWR	D			

FPI	AI	BI	CI	FP2	A2	B2	C2		

ITYPE	IRF	A	AZW	U	SHADE	ABSP	SHDW		

FL	HT	FP	AW	BWL	BWR	D			

FPI	AI	BI	CI	FP2	A2	B2	C2		

ITYPE	IRF	A	AZW	U	SHADE	ABSP	SHDW		

FL	HT	FP	AW	BWL	BWR	D			

FPI	AI	BI	CI	FP2	A2	B2	C2		



Repetition of Data Sheets 13 and 14

ITYPE	IRF	A	AZW	U	SHADE	ABSP	SHDW		

FL	HT	FP	AW	BWL	BWR	D			

FPI	AI	BI	CI	FP2	A2	B2	C2		

ITYPE	IRF	A	AZW	U	SHADE	ABSP	SHDW		

FL	HT	FP	AW	BWL	BWR	D			

FPI	AI	BI	CI	FP2	A2	B2	C2		

ITYPE	IRF	A	AZW	U	SHADE	ABSP	SHDW		

FL	HT	FP	AW	BWL	BWR	D			

FPI	AI	BI	CI	FP2	A2	B2	C2		



Data Sheet 15\*

UENDW: Overall heat transfer coefficient of the end walls (gables) of the attic space, Btuh.

UCELNG: Overall heat transfer coefficient of the ceiling under the attic, Btuh.

AENDW: Area of the attic end walls, sq. ft.

ATCHT: Attic space height, ft.

ARCHGA: Air change per hr. for attic.

AIRNT: Nighttime air change multiplier with respect to ARCHGA.

UENDW	UCELNG	AENDW	ATCHT	ARCHGA	AIRNT				

\* This data sheet provides information for the attic space with a flat roof. If gabled roof, it must be treated as an equivalent flat roof.

IEXTED: Exterior shading control index:

IEXTED = 1 if the exterior shading device is controlled to cut down the direct solar heat gain.

IEXTED = 0 if the exterior shading device is not controlled.

IEXMS: The month at which the exterior shading device control starts.

IEXME: The month at which the exterior shading device control ends.

NTVNT: Outdoor air change per hour (nearest integer value) during the unoccupied period to precool the building. The ventilation system is assumed on only during the cooling hours when  $DB_{MIN} < DB < DB_{MAX}$  (Data Sheet 10).

NVENT: Natural ventilation index

NVENT = 1 if outdoor air is brought in during the occupied period and when the outdoor air temperature is less than TS of Data Sheet 8 to minimize the cooling load.

NVENT = 0 otherwise.

(integer data)

IEXTED	IEXMS	IEXME	NTVNT	NVENT					

## Run Sequence

The step by step procedure to perform the heating and cooling load calculation by using NBSLD on the INFONET system is as follows:

1. Complete the data forms described in this manual.
2. Check the data for probable errors.
3. Turn the computer terminal on.
4. Dial the computer center and listen to the high-pitched tone.
5. Place the telephone receiver onto the acoustic coupler of the terminal.
6. Hit the key "T".

The computer responds with

"PORT:" Port number

"CENTER:"

Type in after "CENTER:" BB

The computer responds then with

"LOGON:"

Type in your identification number after "LOGON:".

7. The computer then returns the carriage of the terminal and types!
8. Every time the computer waits for your command, it responds with ! at the first position of the carriage. Following in the sequence of the commands needed to perform the load calculations.

! EDIT NBSBLI

↑ 1

2

60

61

Type in the data from your data forms as illustrated in Figure C1.

... all the data are completed.

↑ Q

close the data file.

SRU'S: .9

computer time unit used in the data preparation.

! EQUATE 7 WETDAT

Weather tape file name.

! EQUATE 9 SPACE 1

Output tape No. 1.

! EQUATE 10 SPACE 2

Output tape No. 2.

#### 9. Instruction for the terminal data input

Type in the following terminal data:

RUNID, RUNTYP, ASHRAE, IDETAL, METHOD

At this point, the computer starts the load calculation and output such as shown in P103 will be typed out on the terminal.

## Weather Tape Handling

The use of Weather Data Tape 1440 provided by the National Climatic Center may be made as follows:

1. Request the tape containing data for specified years from the National Climatic Center

G. McKay or D. Calloway  
Environmental Data Services  
Asheville, North Carolina 28801  
Telephone: (704) 254-0961

Remember that beginning January 1, 1965 a new program was initiated for most Weather Bureau Stations reducing the number of hourly observations being recorded from 24 to 8 per day. This format is not compatible with NBSLD as it is presently written since it requires hourly weather data. Note that the tape is 7 channel, 556 BPI density and of even parity.

2. Have the tape mailed to INFONET computing center at the following address:

Mr. K. Walls  
Center 1  
INFONET Division  
Computer Science Corporation  
650 North Sepulveda Blvd.  
El Segundo, California 90245

3. Ask INFONET to assign a Volume number such as US001.
4. The tape 1440 is then decoded and stored into a weather data file name of which may be obtained by the following INFONET commands:



! DEVICES, QUEUE 0,0,1

! EQUATE 9 WETDAT

! WETHER

VOL, DENS, PARITY, TRACK Fortran Format

VOL: Tape name. 2A4

DENS: Tape density in BPI. A4

PARITY: Data parity, either even or odd. A4

TRACK: Track number, either 7 or 9. A4

ISKIP, NDAY, IWRITE ... data

where ISKIP: Number of days to be skipped from the beginning of the tape.

NDAY: Number of days for which the weather data are to be stored in the file.

IWRITE = 1: if the weather data are to be printed out on the terminal as they are processed and stored; otherwise zero.

5. The constants of WETDAT may be checked by a separate routine WETAP by

! EQUATE 9 WETDAT

! WETAP

NDAY, NSKIP

where NDAY: Number of days for which the weather data are to be displayed on the terminal.

NSKIP: Number of days to be skipped from the beginning of the file WETDAT.

When the use is made of WETDAT in any other program, it can be read in the Fortran program as follows:

```
READ(9) DB, DP, WB, WS, PB, TC, NTOC, DAY, IYEAR, MONTH, ICITY
```

where DB, DP, WB, WS, PB, TC, and NTOC are all dimensioned 24 and represent respectively dry-bulb temperature, dewpoint temperature, wet-bulb temperature, wind speed, barometric pressure, total cloud amount, and type of cloud.

Table C1

Design Weather Data

Reprinted by permission from the 1972 Handbook of Fundamentals, (American Society of Heating, Refrigerating and Air-Conditioning Engineers, 345 East 47th Street, New York), pp. 669-687.

Climatic Conditions for United States and Canada\*.\*

Col. 1 State and Station <sup>b</sup>	Col. 2 Latitude <sup>c</sup>	Col. 3 Elev., <sup>d</sup> Ft	Winter				Summer						
			Median of Annual Ex- tremes	Col. 4		Col. 5 Coinci- dent Wind Ve- locity <sup>e</sup>	Col. 6 Design Dry-Bulb			Col. 7 Out- door Daily Range <sup>f</sup>	Col. 8 Design Wet-Bulb		
				99%	97½%		1%	2½%	5%		1%	2½%	5%
<b>ALABAMA</b>													
Alexander City.....	33 0	660	12	16	20	L	96	94	93	21	79	78	77
Anniston AP.....	33 4	599	12	17	19	L	96	94	93	21	79	78	77
Auburn.....	32 4	730	17	21	25	L	98	96	95	21	80	79	78
Birmingham AP.....	33 3	610	14	19	22	L	97	94	93	21	79	78	77
Decatur.....	34 4	580	10	15	19	L	97	95	94	22	79	78	77
Dothan AP.....	31 2	321	19	23	27	L	97	95	94	20	81	80	79
Florence AP.....	34 5	528	8	13	17	L	97	95	94	22	79	78	77
Gadsden.....	34 0	570	11	16	20	L	96	94	93	22	78	77	76
Huntsville AP.....	34 4	619	-6	13	17	L	97	95	94	23	78	77	76
Mobile AP.....	30 4	211	21	26	29	M	95	93	91	18	80	79	79
Mobile CO.....	30 4	119	24	28	32	M	96	94	93	16	80	79	79
Montgomery AP.....	32 2	195	18	22	26	L	98	95	93	21	80	79	78
Selma-Craig AFB.....	32 2	207	18	23	27	L	98	96	94	21	81	80	79
Talladega.....	33 3	565	11	15	19	L	97	95	94	21	79	78	77
Tuscaloosa AP.....	33 1	170r	14	19	23	L	98	96	95	22	81	80	79
<b>ALASKA</b>													
Anchorage AP.....	61 1	90	-29	-25	-20	VL	73	70	67	15	63	61	59
Barrow.....	71 2	22	-49	-45	-42	M	58	54	50	12	54	51	48
Fairbanks AP.....	64 5	436	-59	-53	-50	VL	82	78	75	24	64	63	61
Juneau AP.....	58 2	17	-11	-7	-4	L	75	71	68	15	66	64	62
Kodiak.....	57 3	21	4	8	12	M	71	66	63	10	62	60	58
Nome AP.....	64 3	13	-37	-32	-28	L	66	62	59	10	58	56	54
<b>ARIZONA†</b>													
Douglas AP.....	31 3	4098	13	18	22	VL	100	98	96	31	70	69	68
Flagstaff AP.....	35 1	6973	-10	0	5	VL	84	82	80	31	61	60	59
Fort Huachuca AP.....	31 3	4664	18	25	28	VL	95	93	91	27	69	68	67
Kingman AP.....	35 2	3446	18	25	29	VL	103	100	97	30	70	69	69
Nogales.....	31 2	3800	15	20	24	VL	100	98	96	31	72	71	70
Phoenix AP.....	33 3	1117	25	31	34	VL	108	106	104	27	77	76	75
Prescott AP.....	34 4	5014	7	15	19	VL	96	94	91	30	67	66	65
Tucson AP.....	33 1	2584	23	29	32	VL	105	102	100	26	74	73	72
Winslow AP.....	35 0	4880	2	9	13	VL	97	95	92	32	66	65	64
Yuma AP.....	32 4	199	32	37	40	VL	111	109	107	27	79	78	77
<b>ARKANSAS</b>													
Blytheville AFB.....	36 0	264	6	12	17	L	98	96	93	21	80	79	78
Camden.....	33 4	116	13	19	23	L	99	97	96	21	81	80	79
El Dorado AP.....	33 1	252	13	19	23	L	98	96	95	21	81	80	79
Fayetteville AP.....	36 0	1253	3	9	13	M	97	95	93	23	77	76	75
Fort Smith AP.....	35 2	449	9	15	19	M	101	99	96	24	79	78	77
Hot Springs Nat. Pk.....	34 3	710	12	18	22	M	99	97	96	22	79	78	77
Jonesboro.....	35 5	345	8	14	18	M	98	96	95	21	80	79	78
Little Rock AP.....	34 4	257	13	19	23	M	99	96	94	22	80	79	78
Pine Bluff AP.....	34 1	204	14	20	24	L	99	96	95	22	81	80	79
Texarkana AP.....	33 3	361	16	22	26	M	99	97	96	21	80	79	78
<b>CALIFORNIA†</b>													
Bakersfield AP.....	35 2	495	26	31	33	VL	103	101	99	32	72	71	70
Barstow AP.....	34 5	2142	18	24	28	VL	104	102	99	37	73	72	71
Blythe AP.....	33 4	390	26	31	35	VL	111	109	106	28	78	77	76
Burbank AP.....	34 1	699	30	36	38	VL	97	94	91	25	72	70	69
Chico.....	39 5	205	23	29	33	VL	102	100	97	36	71	70	69
Concord.....	38 0	195	27	32	36	VL	96	92	88	32	69	67	66

\* Data for U. S. stations extracted from *Evaluated Weather Data for Cooling Equipment Design, Addendum No. 1, Winter and Summer Data*, with the permission of the publisher, Fluor Products Company, Inc., Box 1267, Santa Rosa, California.

† Data compiled from official weather stations, where hourly weather observations are made by trained observers, and from other sources. Table 1 prepared by ASHRAE Technical Committee 2.2, *Weather Data and Design Conditions*. Percentage of winter design data show the percent of 3-month period, December through February, Canadian data are based on January only. Percentage of summer design data show the percent of 4-month period, June through September. Canadian data are based on July only. Also see References 1 to 7.

‡ When airport temperature observations were used to develop design data, "AP" follows station name, and "AFB" follows Air Force Bases. Data for stations followed by "CO" came from office locations within an urban area and generally reflect an influence of the surrounding area. Stations without designation can be considered semi-rural and may be directly compared with most airport data.

§ Latitude is given to the nearest 10 minutes, for use in calculating solar loads. For example, the latitude for Anniston, Alabama is given as 33°4', or 33°40'.

¶ Elevations are ground elevations for each station as of 1964. Temperature readings are generally made at an elevation of 5 ft above ground, except for locations marked r, indicating roof exposure of thermometer.

‡ Coincident wind velocities derived from approximately coldest 600 hours out of 20,000 hours of December through February data per station. Also see References 5 and 6. The four classifications are:

VL = Very Light, 70 percent or more of cold extreme hours ≤ 7 mph. M = Moderate, 50 to 74 percent cold extreme hours > 7 mph.

L = Light, 50 to 69 percent cold extreme hours ≤ 7 mph. H = High, 75 percent or more cold extreme hours > 7 mph, and 50 percent are > 12 mph.

† The difference between the average maximum and average minimum temperatures during the warmest month.

‡ More detailed data on Arizona, California, and Nevada may be found in *Recommended Design Temperatures, Northern California*, published by the Golden Gate Chapter; and *Recommended Design Temperatures, Southern California, Arizona, Nevada*, published by the Southern California Chapter.



Climatic Conditions for United States and Canada (Continued)\*,a

Col. 1 State and Station <sup>b</sup>	Col. 2 Latitude <sup>c</sup>	Col. 3 Elev. <sup>d</sup> Ft	Winter				Summer						
			Col. 4			Col. 5 Coincident Wind Ve- locity <sup>e</sup>	Col. 6 Design Dry-Bulb			Col. 7 Out- door Daily Range <sup>f</sup>	Col. 8 Design Wet-Bulb		
			Median of Annual Ex- tremes	99%	97½%		1%	2½%	5%		1%	2½%	5%
<b>CALIFORNIA† (continued)</b>													
Covina.....	34 0	575	32	38	41	VL	100	97	94	31	73	72	71
Crescent City AP.....	41 5	50	28	33	36	L	72	69	65	18	61	60	59
Downey.....	34 0	116	30	35	38	VL	93	90	87	22	72	71	70
El Cajon.....	32 4	525	26	31	34	VL	98	95	92	30	74	73	72
El Centro AP.....	32 5	-30	26	31	35	VL	111	109	106	34	81	80	79
Escondido.....	33 0	660	28	33	36	VL	95	92	89	30	73	72	71
Eureka/Arcata AP.....	41 0	217	27	32	35	L	67	65	63	11	60	59	58
Fairfield-Travis AFB.....	38 2	72	26	32	34	VL	98	94	90	34	71	69	67
Fresno AP.....	36 5	326	25	28	31	VL	101	99	97	34	73	72	71
Hamilton AFB.....	38 0	3	28	33	35	VL	89	85	81	28	71	68	66
Laguna Beach.....	33 3	35	32	37	39	VL	83	80	77	18	69	68	67
Livermore.....	37 4	545	23	28	30	VL	99	97	94	24	70	69	68
Lompoc, Vandenburg AFB.....	34 4	552	32	36	38	VL	82	79	76	20	65	63	61
Long Beach AP.....	33 5	34	31	36	38	VL	87	84	81	22	72	70	69
Los Angeles AP.....	34 0	99	36	41	43	VL	86	83	80	15	69	68	67
Los Angeles CO.....	34 0	312	38	42	44	VL	94	90	87	20	72	70	69
Merced-Castle AFB.....	37 2	178	24	30	32	VL	102	99	96	36	73	72	70
Modesto.....	37 4	91	26	32	36	VL	101	98	96	36	72	71	70
Monterey.....	36 4	38	29	34	37	VL	82	79	76	20	64	63	61
Napa.....	38 2	16	26	31	34	VL	94	92	89	30	69	68	67
Needles AP.....	34 5	913	27	33	37	VL	112	110	107	27	76	75	74
Oakland AP.....	37 4	3	30	35	37	VL	85	81	77	19	65	63	62
Oceanside.....	33 1	30	33	38	40	VL	84	81	78	13	69	68	67
Ontario.....	34 0	995	26	32	34	VL	100	97	94	36	72	71	70
Oxnard AFB.....	34 1	43	32	35	37	VL	84	80	78	19	70	69	67
Palmdale AP.....	34 4	2517	18	24	27	VL	103	101	98	35	70	68	67
Palm Springs.....	33 5	411	27	32	36	VL	110	108	105	35	79	78	77
Pasadena.....	34 1	864	31	36	39	VL	96	93	90	29	72	70	69
Petaluma.....	38 1	27	24	29	32	VL	94	90	87	31	70	68	67
Pomona CO.....	34 0	871	26	31	34	VL	99	96	93	36	73	72	71
Redding AP.....	40 3	495	25	31	35	VL	103	101	98	32	70	69	67
Redlands.....	34 0	1318	28	34	37	VL	99	96	93	33	72	71	70
Richmond.....	38 0	55	28	35	38	VL	85	81	77	17	66	64	63
Riverside-March AFB.....	33 5	1511	26	32	34	VL	99	96	94	37	72	71	69
Sacramento AP.....	38 3	17	24	30	32	VL	100	97	94	36	72	70	69
Salinas AP.....	36 4	74	27	32	35	VL	87	85	82	24	67	65	64
San Bernardino, Norton AFB.....	34 1	1125	26	31	33	VL	101	98	96	38	75	73	71
San Diego AP.....	32 4	19	38	42	44	VL	86	83	80	12	71	70	68
San Fernando.....	34 1	977	29	34	37	VL	100	97	94	38	73	72	71
San Francisco AP.....	37 4	8	32	35	37	L	83	79	75	20	65	63	62
San Francisco CO.....	37 5	52	38	42	44	VL	80	77	73	14	64	62	61
San Jose AP.....	37 2	70r	30	34	36	VL	90	88	85	26	69	67	65
San Luis Obispo.....	35 2	315	30	35	37	VL	89	85	82	26	65	64	63
Santa Ana AP.....	33 4	115r	28	33	36	VL	92	89	86	28	72	71	70
Santa Barbara CO.....	34 3	100	30	34	36	VL	87	84	81	24	67	66	65
Santa Cruz.....	37 0	125	28	32	34	VL	87	84	80	28	66	65	63
Santa Maria AP.....	34 5	238	28	32	34	VL	85	82	79	23	65	64	63
Santa Monica CO.....	34 0	57	38	43	45	VL	80	77	74	16	69	68	67
Santa Paula.....	34 2	263	28	33	36	VL	91	89	86	36	72	71	70
Santa Rosa.....	38 3	167	24	29	32	VL	95	93	90	34	70	68	67
Stockton AP.....	37 5	28	25	30	34	VL	101	98	96	37	72	70	69
Ukiah.....	39 1	620	22	27	30	VL	98	96	93	40	70	69	67
Visalia.....	36 2	354	26	32	36	VL	102	100	97	38	73	72	70
Yreka.....	41 4	2625	7	13	17	VL	96	94	91	38	68	66	65
Yuba City.....	39 1	70	24	30	34	VL	102	100	97	36	71	70	69
<b>COLORADO</b>													
Alamosa AP.....	37 3	7536	-26	-17	-13	VL	84	82	79	35	62	61	60
Boulder.....	40 0	5385	-5	4	8	L	92	90	87	27	64	63	62
Colorado Springs AP.....	38 5	6173	-9	-1	4	L	90	88	86	30	63	62	61
Denver AP.....	39 5	5283	-9	-2	3	L	92	90	89	28	65	64	63
Durango.....	37 1	6550	-10	0	4	VL	88	86	83	30	64	63	62

Climatic Conditions for United States and Canada (Continued)\* a

Col. 1 State and Station <sup>b</sup>	Col. 2 Latitude <sup>c</sup>	Col. 3 Elev., <sup>d</sup> Ft	Winter				Summer						
			Col. 4			Col. 5 Coinci- dent Wind Ve- locity <sup>e</sup>	Col. 6 Design Dry-Bulb			Col. 7 Out- door Doily Range <sup>f</sup>	Col. 8 Design Wet-Bulb		
			Median of Annual Ex- tremes	99%	97½%		1%	2½%	5%		1%	2½%	5%
<b>COLORADO (continued)</b>													
Fort Collins.....	40 4	5001	-18	- 9	- 5	L	91	89	86	28	63	62	61
Grand Junction AP.....	39 1	4849	- 2	8	11	VL	96	94	92	29	64	63	62
Greeley.....	40 3	4648	-18	- 9	- 5	L	94	92	89	29	65	64	63
La Junta AP.....	38 0	4188	-14	- 6	- 2	M	97	95	93	31	72	71	69
Leadville.....	39 2	10177	-18	- 9	- 4	VL	76	73	70	30	56	55	54
Pueblo AP.....	38 2	4639	-14	- 5	- 1	L	96	94	92	31	68	67	66
Sterling.....	40 4	3939	-15	- 6	- 2	M	95	93	90	30	67	66	65
Trinidad AP.....	37 2	5746	- 9	- 1	5	L	93	91	89	32	66	65	64
<b>CONNECTICUT</b>													
Bridgeport AP.....	41 1	7	- 1	4	8	M	90	88	85	18	77	76	75
Hartford, Brainard Field.....	41 5	15	- 4	1	5	M	90	88	85	22	77	76	74
New Haven AP.....	41 2	6	0	5	9	H	88	86	83	17	77	76	75
New London.....	41 2	60	0	4	8	H	89	86	83	16	77	75	74
Norwalk.....	41 1	37	- 5	0	4	M	91	89	86	19	77	76	75
Norwich.....	41 3	20	- 7	- 2	2	M	88	86	83	18	77	76	75
Waterbury.....	41 3	605	- 5	0	4	M	90	88	85	21	77	76	75
Windsor Locks, Bradley Field.....	42 0	169	- 7	- 2	2	M	90	88	85	22	76	75	73
<b>DELAWARE</b>													
Dover AFB.....	39 0	38	8	13	15	M	93	90	88	18	79	78	77
Wilmington AP.....	39 4	78	6	12	15	M	93	90	87	20	79	77	76
<b>DISTRICT OF COLUMBIA</b>													
Andrews AFB.....	38 5	279	9	13	16	M	94	91	88	18	79	77	76
Washington National AP.....	38 5	14	12	16	19	M	94	92	90	18	78	77	76
<b>FLORIDA</b>													
Belle Glade.....	26 4	16	31	35	39	M	93	91	90	16	80	79	79
Cape Kennedy AP.....	28 1	16	33	37	40	L	90	89	88	15	81	80	79
Daytona Beach AP.....	29 1	31	28	32	36	L	94	92	91	15	81	80	79
Fort Lauderdale.....	26 0	13	37	41	45	M	91	90	89	15	81	80	79
Fort Myers AP.....	26 4	13	34	38	42	M	94	92	91	18	80	80	79
Fort Pierce.....	27 3	10	33	37	41	M	93	91	90	15	81	80	79
Gainesville AP.....	29 4	155	24	28	32	L	96	94	93	18	80	79	79
Jacksonville AP.....	30 3	24	26	29	32	L	96	94	92	19	80	79	79
Key West AP.....	24 3	6	50	55	58	M	90	89	88	9	80	79	79
Lakeland CO.....	28 0	214	31	35	39	M	95	93	91	17	80	79	78
Miami AP.....	25 5	7	39	44	47	M	92	90	89	15	80	79	79
Miami Beach CO.....	25 5	9	40	45	48	M	91	89	88	10	80	79	79
Ocala.....	29 1	86	25	29	33	L	96	94	93	18	80	79	79
Orlando AP.....	28 3	106r	29	33	37	L	96	94	93	17	80	79	78
Panama City, Tyndall AFB.....	30 0	22	28	32	35	M	92	91	90	14	81	80	80
Pensacola CO.....	30 3	13	25	29	32	M	92	90	89	14	82	81	80
St. Augustine.....	29 5	15	27	31	35	L	94	92	90	16	81	80	79
St. Petersburg.....	28 0	35	35	39	42	M	93	91	90	16	81	80	79
Sanford.....	28 5	14	29	33	37	L	95	93	92	17	80	79	79
Sarasota.....	27 2	30	31	35	39	M	93	91	90	17	80	80	79
Tallahassee AP.....	30 2	58	21	25	29	L	96	94	93	19	80	79	79
Tampa AP.....	28 0	19	32	36	39	M	92	91	90	17	81	80	79
West Palm Beach AP.....	26 4	15	36	40	44	M	92	91	89	16	81	80	80
<b>GEORGIA</b>													
Albany, Turner AFB.....	31 3	224	21	26	30	L	98	96	94	20	80	79	78
Americus.....	32 0	476	18	22	25	L	98	96	93	20	80	79	78
Athens.....	34 0	700	12	17	21	L	96	94	91	21	78	77	76
Atlanta AP.....	33 4	1005	14	18	23	H	95	92	90	19	78	77	76
Augusta AP.....	33 2	143	17	20	23	L	98	95	93	19	80	79	78
Brunswick.....	31 1	14	24	27	31	L	97	95	92	18	81	80	79
Columbus, Lawson AFB.....	32 3	242	19	23	26	L	98	96	94	21	80	79	78
Dalton.....	34 5	720	10	15	19	L	97	95	92	22	78	77	76
Dublin.....	32 3	215	17	21	25	L	98	96	93	20	80	79	78
Gainesville.....	34 2	1254	11	16	20	L	94	92	89	21	78	77	76
Griffin.....	33 1	980	13	17	22	L	95	93	90	21	79	78	77
La Grange.....	33 0	715	12	16	20	L	96	94	92	21	79	78	77
Macon AP.....	32 4	356	18	23	27	L	98	96	94	22	80	79	78
Marietta, Dobbins AFB.....	34 0	1016	12	17	21	L	95	93	91	21	78	77	76



Climatic Conditions for United States and Canada (Continued)\*.a

Col. 1 State and Station <sup>b</sup>	Col. 2 Latitude <sup>c</sup>	Col. 3 Elev., <sup>d</sup> Ft	Winter				Summer						
			Median of Annual Ex- tremes	Col. 4		Col. 5 Coinci- dent Wind Ve- locity <sup>e</sup>	Col. 6 Design Dry-Bulb			Col. 7 Out- door Daily Range <sup>f</sup>	Col. 8 Design Wet-Bulb		
				99%	97½%		1%	2½%	5%		1%	2½%	5%
<b>GEORGIA (continued)</b>													
Moultrie	31 1	340	22	26	30	L	97	95	93	20	80	79	78
Rome AP	34 2	637	11	16	20	L	97	95	93	23	78	77	76
Savannah-Travis AP	32 1	52	21	24	27	L	96	94	92	20	81	80	79
Valdosta-Moody AFB	31 0	239	24	28	31	L	96	94	92	20	80	79	78
Waycross	31 2	140	20	24	28	L	97	95	93	20	80	79	78
<b>HAWAII</b>													
Hilo AP	19 4	31	56	59	61	L	85	83	82	15	74	73	72
Honolulu AP	21 2	7	58	60	62	L	87	85	84	12	75	74	73
Kaneohe	21 2	198	58	60	61	L	85	83	82	12	74	73	73
Wahiawa	21 3	215	57	59	61	L	86	84	83	14	75	74	73
<b>IDAHO</b>													
Boise AP	43 3	2842	0	4	10	L	96	93	91	31	68	66	65
Burley	42 3	4180	- 5	4	8	VL	95	93	89	35	68	66	64
Coeur d'Alene AP	47 5	2973	- 4	2	7	VL	94	91	88	31	66	65	63
Idaho Falls AP	43 3	4730r	-17	-12	- 6	VL	91	88	85	38	65	64	62
Lewiston AP	46 2	1413	1	6	12	VL	98	96	93	32	67	66	65
Moscow	46 4	2660	-11	- 3	1	VL	91	89	86	32	64	63	61
Mountain Home AFB	43 0	2992	- 3	2	9	L	99	96	93	36	68	66	64
Pocatello AP	43 0	4444	-12	- 8	- 2	VL	94	91	88	35	65	63	62
Twin Falls AP	42 3	4148	- 5	4	8	L	96	94	91	34	66	64	63
<b>ILLINOIS</b>													
Aurora	41 5	744	-13	- 7	- 3	M	93	91	88	20	78	77	75
Belleville, Scott AFB	38 3	447	0	6	10	M	97	95	92	21	79	78	77
Bloomington	40 3	775	- 7	- 1	3	M	94	92	89	21	79	78	77
Carbondale	37 5	380	1	7	11	M	98	96	94	21	80	79	78
Champaign/Urbana	40 0	743	- 6	0	4	M	96	94	91	21	79	78	77
Chicago, Midway AP	41 5	610	- 7	- 4	1	M	95	92	89	20	78	76	75
Chicago, O'Hare AP	42 0	658	- 9	- 4	0	M	93	90	87	20	77	75	74
Chicago, CO	41 5	594	- 5	- 3	1	M	94	91	88	15	78	76	75
Danville	40 1	558	- 6	- 1	4	M	96	94	91	21	79	78	76
Decatur	39 5	670	- 6	0	4	M	96	93	91	21	79	78	77
Dixon	41 5	696	-13	- 7	- 3	M	93	91	89	23	78	77	76
Elgin	42 0	820	-14	- 8	- 4	M	92	90	87	21	78	76	75
Freeport	42 2	780	-16	-10	- 6	M	92	90	87	24	78	77	75
Galesburg	41 0	771	-10	- 4	0	M	95	92	89	22	79	78	76
Greenville	39 0	563	- 3	3	7	M	96	94	92	21	79	78	77
Joliet AP	41 3	588	-11	- 5	- 1	M	94	92	89	20	78	77	75
Kankakee	41 1	625	-10	- 4	1	M	94	92	89	21	78	77	76
La Salle/Peru	41 2	520	- 9	- 3	1	M	94	93	90	22	78	77	76
Macomb	40 3	702	- 5	- 3	1	M	95	93	90	22	79	78	77
Moline AP	41 3	582	-12	- 7	- 3	M	94	91	88	23	79	77	76
Mt. Vernon	38 2	500	0	6	10	M	97	95	92	21	79	78	77
Peoria AP	40 4	652	- 8	- 2	2	M	94	92	89	22	78	77	76
Quincy AP	40 0	762	- 8	- 2	2	M	97	95	92	22	80	79	77
Rantoul, Chanute AFB	40 2	740	- 7	- 1	3	M	94	92	89	21	78	77	76
Rockford	42 1	724	-13	- 7	- 3	M	92	90	87	24	77	76	75
Springfield AP	39 5	587	- 7	- 1	4	M	95	92	90	21	79	78	77
Waukegan	42 2	680	-11	- 5	- 1	M	92	90	87	21	77	76	75
<b>INDIANA</b>													
Anderson	40 0	847	- 5	0	5	M	93	91	88	22	78	77	76
Bedford	38 5	670	- 3	3	7	M	95	93	90	22	79	78	77
Bloomington	39 1	820	- 3	3	7	M	95	92	90	22	79	78	76
Columbus, Bakalar AFB	39 2	661	- 3	3	7	M	95	92	90	22	79	78	76
Crawfordsville	40 0	752	- 8	- 2	2	M	95	93	90	22	79	77	76
Evansville AP	38 0	381	1	6	10	M	96	94	91	22	79	78	77
Fort Wayne AP	41 0	791	- 5	0	5	M	93	91	88	24	77	76	75
Goshen AP	41 3	823	-10	- 4	0	M	92	90	87	23	77	76	74
Hobart	41 3	600	-10	- 4	0	M	93	91	88	21	78	76	75
Huntington	40 4	802	- 8	- 2	2	M	94	92	89	23	78	76	75
Indianapolis AP	39 4	793	- 5	0	4	M	93	91	88	22	78	77	76
Jeffersonville	38 2	455	3	9	13	M	96	94	91	23	79	78	77
Kokomo	40 3	790	- 6	0	4	M	94	92	89	22	78	76	75
Lafayette	40 2	600	- 7	- 1	3	M	94	92	89	22	78	77	76

Climatic Conditions for United States and Canada (Continued)\*.a

Col. 1 State and Station <sup>b</sup>	Col. 2 Latitude <sup>c</sup>	Col. 3 Elev. <sup>d</sup> Ft	Winter				Summer						
			Col. 4			Col. 5 Coincident Wind Ve- locity <sup>e</sup>	Col. 6 Design Dry-Bulb			Col. 7 Out- door Daily Range <sup>f</sup>	Col. 8 Design Wet-Bulb		
			Median of Annual Ex- tremes	99%	97½%		1%	2½%	5%		1%	2½%	5%
<b>INDIANA (continued)</b>													
La Porte.....	41 3	810	-10	-4	0	M	93	91	88	22	77	76	74
Marion.....	40 3	791	-8	-2	2	M	93	91	88	23	78	76	75
Muncie.....	40 1	955	-8	-2	2	M	93	91	88	22	78	77	75
Peru, Bunker Hill AFB.....	40 4	804	-9	-3	1	M	91	89	86	22	77	76	74
Richmond AP.....	39 5	1138	-7	-1	3	M	93	91	88	22	78	77	75
Shelbyville.....	39 3	765	-4	2	6	M	94	92	89	22	78	77	76
South Bend AP.....	41 4	773	-6	-2	3	M	92	89	87	22	77	76	74
Terre Haute AP.....	39 3	601	-3	3	7	M	95	93	91	22	79	78	77
Valparaiso.....	41 2	801	-12	-6	-2	M	92	90	87	22	78	76	75
Vincennes.....	38 4	420	-1	5	9	M	96	94	91	22	79	78	77
<b>IOWA</b>													
Ames.....	42 0	1004	-17	-11	-7	M	94	92	89	23	79	78	76
Burlington AP.....	40 5	694	-10	-4	0	M	95	92	89	22	80	78	77
Cedar Rapids AP.....	41 5	863	-14	-8	-4	M	92	90	87	23	78	76	75
Clinton.....	41 5	595	-13	-7	-3	M	92	90	87	23	78	77	76
Council Bluffs.....	41 2	1210	-14	-7	-3	M	97	94	91	22	79	78	76
Des Moines AP.....	41 3	948 <sup>r</sup>	-13	-7	-3	M	95	92	89	23	79	77	76
Dubuque.....	42 2	1065	-17	-11	-7	M	92	90	87	22	78	76	75
Fort Dodge.....	42 3	1111	-18	-12	-8	M	94	92	89	23	78	77	75
Iowa City.....	41 4	645	-14	-8	-4	M	94	91	88	22	79	77	76
Keokuk.....	40 2	526	-9	-3	1	M	95	93	90	22	79	78	77
Marshalltown.....	42 0	898	-16	-10	-6	M	93	91	88	23	79	77	76
Mason City AP.....	43 1	1194	-20	-13	-9	M	91	88	85	24	77	75	74
Newton.....	41 4	946	-15	-9	-5	M	95	93	90	23	79	77	76
Ottumwa AP.....	41 1	842	-12	-6	-2	M	95	93	90	22	79	78	76
Sioux City AP.....	42 2	1095	-17	-10	-6	M	96	93	90	24	79	77	76
Waterloo.....	42 3	868	-18	-12	-8	M	91	89	86	23	78	76	75
<b>KANSAS</b>													
Atchison.....	39 3	945	-9	-2	2	M	97	95	92	23	79	78	77
Chanute AP.....	37 4	977	-3	3	7	H	99	97	95	23	79	78	77
Dodge City AP.....	37 5	2594	-5	3	7	M	99	97	95	25	74	73	72
El Dorado.....	37 5	1282	-3	4	8	H	101	99	96	24	78	77	76
Emporia.....	38 2	1209	-4	3	7	H	99	97	94	25	78	77	76
Garden City AP.....	38 0	2882	-10	-1	3	M	100	98	96	28	74	73	72
Goodland AP.....	39 2	3645	-10	-2	4	M	99	96	93	31	71	70	69
Great Bend.....	38 2	1940	-5	2	6	M	101	99	96	28	77	76	75
Hutchinson AP.....	38 0	1524	-5	2	6	H	101	99	96	28	77	76	75
Liberal.....	37 0	2838	-4	4	8	M	102	100	99	28	74	73	71
Manhattan, Fort Riley.....	39 0	1076	-7	-1	4	H	101	98	95	24	79	78	77
Parsons.....	37 2	908	-2	5	9	H	99	97	94	23	79	78	77
Russell AP.....	38 5	1864	-7	0	4	M	102	100	97	29	78	76	75
Salina.....	38 5	1271	-4	3	7	H	101	99	96	26	78	76	75
Topeka AP.....	39 0	877	-4	3	6	M	99	96	94	24	79	78	77
Wichita AP.....	37 4	1321	-1	5	9	H	102	99	96	23	77	76	75
<b>KENTUCKY</b>													
Ashland.....	38 3	551	1	6	10	L	94	92	89	22	77	76	75
Bowling Green AP.....	37 0	535	1	7	11	L	97	95	93	21	79	78	77
Corbin AP.....	37 0	1175	0	5	9	L	93	91	89	23	79	77	76
Covington AP.....	39 0	869	-3	3	8	L	93	90	88	22	77	76	75
Hopkinsville, Campbell AFB.....	36 4	540	4	10	14	L	97	95	92	21	79	78	77
Lexington AP.....	38 0	979	0	6	10	M	94	92	90	22	78	77	76
Louisville AP.....	38 1	474	1	8	12	L	96	93	91	23	79	78	77
Madisonville.....	37 2	439	1	7	11	L	96	94	92	22	79	78	77
Owensboro.....	37 5	420	0	6	10	L	96	94	92	23	79	78	77
Paducah AP.....	37 0	398	4	10	14	L	97	95	94	20	80	79	78
<b>LOUISIANA</b>													
Alexandria AP.....	31 2	92	20	25	29	L	97	95	94	20	80	80	79
Baton Rouge AP.....	30 3	64	22	25	30	L	96	94	92	19	81	80	79
Bogalusa.....	30 5	103	20	24	28	L	96	94	93	19	80	79	78
Houma.....	29 3	13	25	29	33	L	94	92	91	15	81	80	79
Lafayette AP.....	30 1	38	23	28	32	L	95	93	92	18	81	81	80
Lake Charles AP.....	30 1	14	25	29	33	M	95	93	91	17	80	79	79
Minden.....	32 4	250	17	22	26	L	98	96	95	20	81	80	79

Climatic Conditions for United States and Canada (Continued)\*-a

Col. 1 State and Station <sup>b</sup>	Col. 2 Latitude <sup>c</sup>	Col. 3 Elev., <sup>d</sup> Ft	Winter				Summer						
			Col. 4			Col. 5 Coinci- dent Wind Ve- locity <sup>e</sup>	Col. 6 Design Dry-Bulb			Col. 7 Out- door Daily Range <sup>f</sup>	Col. 8 Design Wet-Bulb		
			Median of Annual Ex- tremes	99%	97½%		1%	2½%	5%		1%	2½%	5%
<b>LOUISIANA (continued)</b>													
Monroe AP.....	32 3	78	18	23	27	L	98	96	95	20	81	81	80
Natchitoches.....	31 5	120	17	22	26	L	99	97	96	20	81	80	79
New Orleans AP.....	30 0	3	29	32	35	M	93	91	90	16	81	80	79
Shreveport AP.....	32 3	252	18	22	26	M	99	96	94	20	81	80	79
<b>MAINE</b>													
Augusta AP.....	44 2	350	-13	-7	-3	M	88	86	83	22	74	73	71
Bangor, Dow AFB.....	44 5	162	-14	-8	-4	M	88	85	81	22	75	73	71
Caribou AP.....	46 5	624	-24	-18	-14	L	85	81	78	21	72	70	68
Lewiston.....	44 0	182	-14	-8	-4	M	88	86	83	22	74	73	71
Millinocket AP.....	45 4	405	-22	-16	-12	L	87	85	82	22	74	72	70
Portland AP.....	43 4	61	-14	-5	0	L	88	85	81	22	75	73	71
Waterville.....	44 3	89	-15	-9	-5	M	88	86	82	22	74	73	71
<b>MARYLAND</b>													
Baltimore AP.....	39 1	146	8	12	15	M	94	91	89	21	79	78	77
Baltimore CO.....	39 2	14	12	16	20	M	94	92	89	17	79	78	77
Cumberland.....	39 4	945	0	5	9	L	94	92	89	22	76	75	74
Frederick AP.....	39 2	294	2	7	11	M	94	92	89	22	78	77	76
Hagerstown.....	39 4	660	1	6	10	L	94	92	89	22	77	76	75
Salisbury.....	38 2	52	10	14	18	M	92	90	87	18	79	78	77
<b>MASSACHUSETTS</b>													
Boston AP.....	42 2	15	-1	6	10	H	91	88	85	16	76	74	73
Clinton.....	42 2	398	-8	-2	2	M	87	85	82	17	75	74	72
Fall River.....	41 4	190	-1	5	9	H	88	86	83	18	75	74	73
Framingham.....	42 2	170	-7	-1	3	M	91	89	86	17	76	74	73
Gloucester.....	42 3	10	-4	2	6	H	86	84	81	15	74	73	72
Greenfield.....	42 3	205	-12	-6	-2	M	89	87	84	23	75	74	73
Lawrence.....	42 4	57	-9	-3	1	M	90	88	85	22	76	74	72
Lowell.....	42 3	90	-7	-1	3	M	91	89	86	21	76	74	72
New Bedford.....	41 4	70	3	9	13	H	86	84	81	19	75	73	72
Pittsfield AP.....	42 3	1170	-11	-5	-1	M	86	84	81	23	74	72	71
Springfield, Westover AFB.....	42 1	247	-8	-3	2	M	91	88	85	19	76	74	73
Taunton.....	41 5	20	-9	-4	0	H	88	86	83	18	76	75	74
Worcester AP.....	42 2	986	-8	-3	1	M	89	87	84	18	75	73	71
<b>MICHIGAN</b>													
Adrian.....	41 5	754	-6	0	4	M	93	91	88	23	76	75	74
Alpena AP.....	45 0	689	-11	-5	-1	M	87	85	82	27	74	73	71
Battle Creek AP.....	42 2	939	-6	1	5	M	92	89	86	23	76	74	73
Benton Harbor AP.....	42 1	649	-7	-1	3	M	90	88	85	20	76	74	73
Detroit Met. CAP.....	42 2	633	0	4	8	M	92	88	85	20	76	75	74
Escanaba.....	45 4	594	-13	-7	-3	M	82	80	77	17	73	71	69
Flint AP.....	43 0	766	-7	-1	3	M	89	87	84	25	76	75	74
Grand Rapids AP.....	42 5	681	-3	2	6	M	91	89	86	24	76	74	73
Holland.....	42 5	612	-4	2	6	M	90	88	85	22	76	74	73
Jackson AP.....	42 2	1003	-6	0	4	M	92	89	86	23	76	75	74
Kalamazoo.....	42 1	930	-5	1	5	M	92	89	86	23	76	75	74
Lansing AP.....	42 5	852	-4	2	6	M	89	87	84	24	76	75	73
Marquette CO.....	46 3	677	-14	-8	-4	L	88	86	83	18	73	71	69
Mt. Pleasant.....	43 4	796	-9	-3	1	M	89	87	84	24	75	74	73
Muskegon AP.....	43 1	627	-2	4	8	M	87	85	82	21	75	74	73
Pontiac.....	42 4	974	-6	0	4	M	90	88	85	21	76	75	73
Port Huron.....	43 0	586	-6	-1	3	M	90	88	85	21	76	74	73
Saginaw AP.....	43 3	662	-7	-1	3	M	88	86	83	23	76	75	73
Sault Ste. Marie AP.....	46 3	721	-18	-12	-8	L	83	81	78	23	73	71	69
Traverse City AP.....	44 4	618	-6	0	4	M	89	86	83	22	75	73	72
Ypsilanti.....	42 1	777	-3	-1	5	M	92	89	86	22	76	74	73
<b>MINNESOTA</b>													
Albert Lea.....	43 4	1235	-20	-14	-10	M	91	89	86	24	77	76	74
Alexandria AP.....	45 5	1421	-26	-19	-15	L	90	88	85	24	76	74	72
Bemidji AP.....	47 3	1392	-38	-32	-28	L	87	84	81	24	73	72	71
Brainerd.....	46 2	1214	-31	-24	-20	L	88	85	82	24	74	73	72
Duluth AP.....	46 5	1426	-25	-19	-15	M	85	82	79	22	73	71	69
Faribault.....	44 2	1190	-23	-16	-12	L	90	88	85	24	77	75	74
Fergus Falls.....	46 1	1210	-28	-21	-17	L	92	89	86	24	75	74	72
International Falls AP.....	48 3	1179	-35	-29	-24	L	86	82	79	26	72	69	68



Climatic Conditions for United States and Canada (Continued)\*.a

Col. 1 State and Station <sup>b</sup>	Col. 2 Latitude <sup>c</sup>	Col. 3 Elev. <sup>d</sup> ft	Winter				Summer						
			Col. 4			Col. 5 Coincident Wind Velocity <sup>e</sup>	Col. 6 Design Dry-Bulb			Col. 7 Out- door Daily Range <sup>f</sup>	Col. 8 Design Wet-Bulb		
			Median of Annual Ex- tremes	99%	97½%		1%	2½%	5%		1%	2½%	5%
<b>MINNESOTA (continued)</b>													
Mankato	44 1	785	-23	-16	-12	L	91	89	86	24	77	75	74
Minneapolis/St. Paul AP	44 5	822	-19	-14	-10	L	92	89	86	22	77	75	74
Rochester AP	44 0	1297	-23	-17	-13	M	90	88	85	24	77	75	74
St. Cloud AP	45 4	1034	-26	-20	-16	L	90	88	85	24	77	75	73
Virginia	47 3	1435	-32	-25	-21	L	86	83	80	23	73	71	69
Willmar	45 1	1133	-25	-18	-14	L	91	88	85	24	77	75	73
Winona	44 1	652	-19	-12	-8	M	91	89	86	24	77	76	74
<b>MISSISSIPPI</b>													
Biloxi, Keesler AFB	30 2	25	26	30	32	M	93	92	90	16	82	81	80
Clarksdale	34 1	178	14	20	24	L	98	96	95	21	81	80	79
Columbus AFB	33 4	224	13	18	22	L	97	95	93	22	79	79	78
Greenville AFB	33 3	139	16	21	24	L	98	96	94	21	81	80	79
Greenwood	33 3	128	14	19	23	L	98	96	94	21	81	80	79
Hattiesburg	31 2	200	18	22	26	L	97	95	94	21	80	79	78
Jackson AP	32 2	330	17	21	24	L	98	96	94	21	79	78	78
Laurel	31 4	264	18	22	26	L	97	95	94	21	80	79	78
McComb AP	31 2	458	18	22	26	L	96	94	93	18	80	79	79
Meridian AP	32 2	294	15	20	24	L	97	95	94	22	80	79	78
Natchez	31 4	168	18	22	26	L	96	94	93	21	80	80	79
Tupelo	34 2	289	13	18	22	L	98	96	95	22	80	79	78
Vicksburg CO	32 2	234	18	23	26	L	97	95	94	21	80	80	79
<b>MISSOURI</b>													
Cape Girardeau	37 1	330	2	8	12	M	98	96	94	21	80	79	78
Columbia AP	39 0	778	-4	2	6	M	97	95	92	22	79	78	77
Farmington AP	37 5	928	-2	4	8	M	97	95	93	22	79	78	77
Hannibal	39 4	489	-7	-1	4	M	96	94	91	22	79	78	77
Jefferson City	38 4	640	-4	2	6	M	97	95	93	23	79	78	77
Joplin AP	37 1	982	1	7	11	M	97	95	93	24	79	78	77
Kansas City AP	39 1	742	-2	4	8	M	100	97	94	20	79	77	76
Kirkville AP	40 1	966	-13	-7	-3	M	96	94	91	24	79	78	77
Mexico	39 1	775	-7	-1	3	M	96	94	91	22	79	78	77
Moberly	39 3	850	-8	-2	2	M	96	94	91	23	79	78	77
Poplar Bluff	36 5	322	3	9	13	M	98	96	94	22	80	79	78
Rolla	38 0	1202	-3	3	7	M	97	95	93	22	79	78	77
St. Joseph AP	39 5	809	-8	-1	3	M	97	95	92	23	79	78	77
St. Louis AP	38 5	535	-2	4	8	M	98	95	92	21	79	78	77
St. Louis CO	38 4	465	1	7	11	M	96	94	92	18	79	78	77
Sedalia, Whiteman AFB	38 4	838	-2	4	9	M	97	94	92	22	79	77	76
Sikeston	36 5	318	4	10	14	L	98	96	94	21	80	79	78
Springfield AP	37 1	1265	0	5	10	M	97	94	91	23	78	77	76
<b>MONTANA</b>													
Billings AP	45 5	3567	-19	-10	-6	L	94	91	88	31	68	66	65
Bozeman	45 5	4856	-25	-15	-11	L	88	85	82	32	61	60	59
Butte AP	46 0	5526r	-34	-24	-16	VL	86	83	80	35	60	59	57
Cut Bank AP	48 4	3838r	-32	-23	-17	L	89	86	82	35	65	63	61
Glasgow AP	48 1	2277	-33	-25	-20	L	96	93	89	29	69	67	65
Glendive	47 1	2076	-28	-20	-16	L	96	93	90	29	71	69	68
Great Falls AP	47 3	3664r	-29	-20	-16	L	91	88	85	28	64	63	61
Havre	48 3	2488	-32	-22	-15	M	91	87	84	33	66	64	63
Helena AP	46 4	3893	-27	-17	-13	L	90	87	84	32	65	63	61
Kalispell AP	48 2	2965	-17	-7	-3	VE	88	84	81	34	65	63	62
Lewiston AP	47 0	4132	-27	-18	-14	L	89	86	83	30	65	63	62
Livingston AP	45 4	4653	-26	-17	-13	L	91	88	85	32	63	62	61
Miles City AP	46 3	2629	-27	-19	-15	L	97	94	91	30	71	69	68
Missoula AP	46 5	3200	-16	-7	-3	VL	92	89	86	36	65	63	61
<b>NEBRASKA</b>													
Beatrice	40 2	1235	-10	-3	1	M	99	97	94	24	78	77	76
Chadron AP	42 5	3300	-21	-13	-9	M	97	95	92	30	72	70	69
Columbus	41 3	1442	-14	-7	-3	M	98	96	93	25	78	76	75
Fremont	41 3	1203	-14	-7	-3	M	99	97	94	22	78	77	76
Grand Island AP	41 0	1841	-14	-6	-2	M	98	95	92	28	76	75	74
Hastings	40 4	1932	-11	-3	1	M	98	96	94	27	77	75	74
Kearney	40 4	2146	-14	-6	-2	M	97	95	92	28	76	75	74
Lincoln CO	40 5	1150	-10	-4	0	M	100	96	93	24	78	77	76

Climatic Conditions for United States and Canada (Continued)\*.a

Col. 1 State and Station <sup>b</sup>	Col. 2 Latitude <sup>c</sup>	Col. 3 Elev. <sup>d</sup> Ft	Winter				Summer						
			Median of Annual Ex- tremes	Col. 4		Col. 5 Coin- cident Wind Ve- locity <sup>e</sup>	Col. 6 Design Dry-Bulb			Col. 7 Out- door Daily Range <sup>f</sup>	Col. 8 Design Wet-Bulb		
				99%	97½%		1%	2½%	5%		1%	2½%	5%
<b>NEBRASKA (continued)</b>													
McCook.....	40 1	2565	-12	-4	0	M	99	97	94	28	74	72	71
Norfolk.....	42 0	1532	-18	-11	-7	M	97	95	92	30	78	76	75
North Platte AP.....	41 1	2779	-13	-6	-2	M	97	94	90	28	74	73	72
Omaha AP.....	41 2	978	-12	-5	-1	M	97	94	91	22	79	78	76
Scottsbluff AP.....	41 5	3950	-16	-8	-4	M	96	94	91	31	70	69	67
Sidney AP.....	41 1	4292	-15	-7	-2	M	95	92	89	31	70	69	67
<b>NEVADA†</b>													
Carson City.....	39 1	4675	-4	3	7	VL	93	91	88	42	62	61	60
Elko AP.....	40 5	5075	-21	-13	-7	VL	94	92	90	42	64	62	61
Ely AP.....	39 1	6257	-15	-6	-2	VL	90	88	86	39	60	59	58
Las Vegas AP.....	36 1	2162	18	23	26	VL	108	106	104	30	72	71	70
Lovelock AP.....	40 0	3900	0	7	11	VL	98	96	93	42	65	64	62
Reno AP.....	39 3	4404	-2	2	7	VL	95	92	90	45	64	62	61
Reno CO.....	39 3	4490	8	12	17	VL	94	92	89	45	64	62	61
Tonopah AP.....	38 0	5426	2	9	13	VL	95	92	90	40	64	63	62
Winnemucca AP.....	40 5	4299	-8	1	5	VL	97	95	93	42	64	62	61
<b>NEW HAMPSHIRE</b>													
Berlin.....	44 3	1110	-25	-19	-15	L	87	85	82	22	73	71	70
Claremont.....	43 2	420	-19	-13	-9	L	89	87	84	24	74	73	72
Concord AP.....	43 1	339	-17	-11	-7	M	91	88	85	26	75	73	72
Keene.....	43 0	490	-17	-12	-8	M	90	88	85	24	75	73	72
Laconia.....	43 3	505	-22	-16	-12	M	89	87	84	25	74	73	72
Manchester, Grenier AFB.....	43 0	253	-11	-5	1	M	92	89	86	24	76	74	73
Portsmouth, Pease AFB.....	43 1	127	-8	-2	3	M	88	86	83	22	75	73	72
<b>NEW JERSEY</b>													
Atlantic City CO.....	39 3	11	10	14	18	H	91	88	85	18	78	77	76
Long Branch.....	40 2	20	4	9	13	H	93	91	88	18	77	76	75
Newark AP.....	40 4	11	6	11	15	M	94	91	88	20	77	76	75
New Brunswick.....	40 3	86	3	8	12	M	91	89	86	19	77	76	75
Paterson.....	40 5	100	3	8	12	M	93	91	88	21	77	76	75
Phillipsburg.....	40 4	180	1	6	10	L	93	91	88	21	77	76	75
Trenton CO.....	40 1	144	7	12	16	M	92	90	87	19	78	77	76
Vineland.....	39 3	95	7	12	16	M	93	90	87	19	78	77	76
<b>NEW MEXICO</b>													
Alamogordo, Holloman AFB.....	32 5	4070	12	18	22	L	100	98	96	30	70	69	68
Albuquerque AP.....	35 0	5310	6	14	17	L	96	94	92	27	66	65	64
Artesia.....	32 5	3375	9	16	19	L	101	99	97	30	71	70	69
Carlsbad AP.....	32 2	3234	11	17	21	L	101	99	97	28	72	71	70
Clovis AP.....	34 3	4279	2	14	17	L	99	97	95	28	70	69	68
Farmington AP.....	36 5	5495	-3	6	9	VL	95	93	91	30	66	65	64
Gallup.....	35 3	6465	-13	-5	-1	VL	92	90	87	32	64	63	62
Grants.....	35 1	6520	-15	-7	-3	VL	91	89	86	32	64	63	62
Hobbs AP.....	32 4	3664	9	15	19	L	101	99	96	29	72	71	70
Las Cruces.....	32 2	3900	13	19	23	L	102	100	97	30	70	69	68
Los Alamos.....	35 5	7410	-4	5	9	L	88	86	83	32	64	63	62
Raton AP.....	36 5	6379	-11	-2	2	L	92	90	88	34	66	65	64
Roswell, Walker AFB.....	33 2	3643	5	16	19	L	101	99	97	33	71	70	69
Santa Fe CO.....	35 4	7045	-2	7	11	L	90	88	85	28	65	63	62
Silver City AP.....	32 4	5373	8	14	18	VL	95	93	91	30	68	67	66
Socorro AP.....	34 0	4617	6	13	17	L	99	97	94	30	67	66	65
Tucumcari AP.....	35 1	4053	1	9	13	L	99	97	95	28	71	70	69
<b>NEW YORK</b>													
Albany AP.....	42 5	277	-14	-5	0	L	91	88	85	23	76	74	73
Albany CO.....	42 5	19	-5	1	5	L	91	89	86	20	76	74	73
Auburn.....	43 0	715	-10	-2	2	M	89	87	84	22	75	73	72
Batavia.....	43 0	900	-7	-1	3	M	89	87	84	22	75	74	72
Binghamton CO.....	42 1	858	-8	-2	2	L	91	89	86	20	74	72	71
Buffalo AP.....	43 0	705r	-3	3	6	M	88	86	83	21	75	73	72
Cortland.....	42 4	1129	-11	-5	-1	L	90	88	85	23	75	73	72
Dunkirk.....	42 3	590	-2	4	8	M	88	86	83	18	75	74	72
Elmira AP.....	42 1	860	-5	1	5	L	92	90	87	24	75	73	72
Geneva.....	42 5	590	-8	-2	2	M	91	89	86	22	75	73	72
Glens Falls.....	43 2	321	-17	-11	-7	L	88	86	83	23	74	72	71
Gloversville.....	43 1	770	-12	-6	-2	L	89	87	84	23	75	73	71
Hornell.....	42 2	1325	-15	-9	-5	L	87	85	82	24	74	72	71



Climatic Conditions for United States and Canada (Continued)\*.a

Col. 1 State and Station <sup>b</sup>	Col. 2 Latitude <sup>c</sup>	Col. 3 Elev., <sup>d</sup> Ft	Winter				Summer						
			Median of Annual Ex- tremes	Col. 4		Col. 5 Coinci- dent Wind Ve- locity <sup>e</sup>	Col. 6 Design Dry-Bulb			Col. 7 Out- door Daily Range <sup>f</sup>	Col. 8 Design Wet-Bulb		
				99%	97½%		1%	2½%	5%		1%	2½%	5%
<b>NEW YORK (continued)</b>													
Ithaca.....	42 3	950	-10	- 4	0	L	91	88	85	24	75	73	72
Jamestown.....	42 1	1390	- 5	- 1	5	M	88	86	83	20	75	73	72
Kingston.....	42 0	279	- 8	- 2	2	L	92	90	87	22	76	74	73
Lockport.....	43 1	520	- 4	- 2	6	M	87	85	82	21	75	74	72
Massena AP.....	45 0	202r	-22	-16	-12	M	86	84	81	20	75	74	72
Newburgh-Stewart AFB.....	41 3	460	- 4	- 2	6	M	92	89	86	21	78	76	74
NYC-Central Park.....	40 5	132	6	11	15	H	94	91	88	17	77	76	75
NYC-Kennedy AP.....	40 4	16	12	17	21	H	91	87	84	16	77	76	75
NYC-LaGuardia AP.....	40 5	19	7	12	16	H	93	90	87	16	77	76	75
Niagara Falls AP.....	43 1	596	- 2	- 4	- 7	M	88	86	83	20	75	74	73
Olean.....	42 1	1420	-13	- 8	- 3	L	87	85	82	23	74	72	71
Oneonta.....	42 3	1150	-13	- 7	- 3	L	89	87	84	24	74	72	71
Oswego CO.....	43 3	300	- 4	- 2	6	M	86	84	81	20	75	74	72
Plattsburg AFB.....	44 4	165	-16	-10	- 6	L	86	84	81	22	74	73	71
Poughkeepsie.....	41 4	103	- 6	- 1	3	L	93	90	87	21	77	75	74
Rochester AP.....	43 1	543	- 5	- 2	5	M	91	88	85	22	75	74	72
Rome-Griffiss AFB.....	43 1	515	-13	- 7	- 3	L	90	87	84	22	76	74	73
Schenectady.....	42 5	217	-11	- 5	- 1	L	90	88	85	22	75	73	72
Suffolk County AFB.....	40 5	57	4	9	13	H	87	84	81	16	76	75	74
Syracuse AP.....	43 1	424	-10	- 2	2	M	90	87	85	20	76	74	73
Utica.....	43 1	714	-12	- 6	- 2	L	89	87	84	22	75	73	72
Watertown.....	44 0	497	-20	-14	-10	M	86	84	81	20	75	74	72
<b>NORTH CAROLINA</b>													
Asheville AP.....	35 3	2170r	8	13	17	L	91	88	86	21	75	74	73
Charlotte AP.....	35 1	735	13	18	22	L	96	94	92	20	78	77	76
Durham.....	36 0	406	11	15	19	L	94	92	89	20	78	77	76
Elizabeth City AP.....	36 2	10	14	18	22	M	93	91	89	18	80	79	78
Fayetteville, Pope AFB.....	35 1	95	13	17	20	L	97	94	92	20	80	79	78
Goldsboro, Seymour-Johnson AFB.....	35 2	88	14	18	21	M	95	92	90	18	80	79	78
Greensboro AP.....	36 1	897	9	14	17	L	94	91	89	21	77	76	75
Greenville.....	35 4	25	14	18	22	M	95	93	90	19	81	80	79
Henderson.....	36 2	510	8	12	16	L	94	92	89	20	79	78	77
Hickory.....	35 4	1165	9	14	18	L	93	91	88	21	77	76	75
Jacksonville.....	34 5	24	17	21	25	M	94	92	89	18	81	80	79
Lumberton.....	34 4	132	14	18	22	L	95	93	90	20	81	80	79
New Bern AP.....	35 1	17	14	18	22	L	94	92	89	18	81	80	79
Raleigh/Durham AP.....	35 5	433	13	16	20	L	95	92	90	20	79	78	77
Rocky Mount.....	36 0	81	12	16	20	L	95	93	90	19	80	79	78
Wilmington AP.....	34 2	30	19	23	27	L	93	91	89	18	82	81	80
Winston-Salem AP.....	36 1	967	9	14	17	L	94	91	89	20	77	76	75
<b>NORTH DAKOTA</b>													
Bismarck AP.....	46 5	1647	-31	-24	-19	VL	95	91	88	27	74	72	70
Devil's Lake.....	48 1	1471	-30	-23	-19	M	93	89	86	25	73	71	69
Dickinson AP.....	46 5	2595	-31	-23	-19	L	96	93	90	25	72	70	68
Fargo AP.....	46 5	900	-28	-22	-17	L	92	88	85	25	76	74	72
Grand Forks AP.....	48 0	832	-30	-26	-23	L	91	87	84	25	74	72	70
Jamestown AP.....	47 0	1492	-29	-22	-18	L	95	91	88	26	75	73	71
Minot AP.....	48 2	1713	-31	-24	-20	M	91	88	84	25	72	70	68
Williston.....	48 1	1877	-28	-21	-17	M	94	90	87	25	71	69	67
<b>OHIO</b>													
Akron/Canton AP.....	41 0	1210	- 5	1	6	M	89	87	84	21	75	73	72
Ashtabula.....	42 0	690	- 3	3	7	M	89	87	84	18	76	75	74
Athens.....	39 2	700	- 3	3	7	M	93	91	88	22	77	76	75
Bowling Green.....	41 3	675	- 7	- 1	3	M	93	91	88	23	77	75	74
Cambridge.....	40 0	800	- 6	0	4	M	91	89	86	23	77	76	75
Chillicothe.....	39 2	638	- 1	5	9	M	93	91	88	22	77	76	75
Cincinnati CO.....	39 1	761	- 2	8	12	L	94	92	90	21	78	77	76
Cleveland AP.....	41 2	777r	- 2	2	7	M	91	89	86	22	76	75	74
Columbus AP.....	40 0	812	- 1	2	7	M	92	88	86	24	77	76	75
Dayton AP.....	39 5	997	- 2	0	6	M	92	90	87	20	77	75	74
Defiance.....	41 2	700	- 7	- 1	1	M	93	91	88	24	77	76	74
Findlay AP.....	41 0	797	- 6	0	4	M	92	90	88	24	77	76	75



Climatic Conditions for United States and Canada (Continued)\*.a

Col. 1 State and Station <sup>b</sup>	Col. 2 Latitude <sup>c</sup>	Col. 3 Elev., <sup>d</sup> Ft	Winter				Summer						
			Col. 4			Col. 5 Coincident Wind Ve- locity <sup>e</sup>	Col. 6 Design Dry-Bulb			Col. 7 Out- door Daily Range <sup>f</sup>	Col. 8 Design Wet-Bulb		
			Median of Annual Ex- tremes	99%	97½%		1%	2½%	5%		1%	2½%	5%
<b>OHIO (continued)</b>													
Fremont.....	41 2	600	- 7	- 1	3	M	92	90	87	24	76	75	74
Hamilton.....	39 2	650	- 2	4	8	M	94	92	90	22	78	77	76
Lancaster.....	39 4	920	- 5	1	5	M	93	91	88	23	77	76	75
Lima.....	40 4	860	- 6	0	4	M	93	91	88	24	77	76	75
Mansfield AP.....	40 5	1297	- 7	1	3	M	91	89	86	22	76	75	74
Marion.....	40 4	920	- 5	1	6	M	93	91	88	23	77	76	75
Middletown.....	39 3	635	- 3	3	7	M	93	91	88	22	77	76	75
Newark.....	40 1	825	- 7	- 1	3	M	92	90	87	23	77	76	75
Norwalk.....	41 1	720	- 7	- 1	3	M	92	90	87	22	76	75	74
Portsmouth.....	38 5	530	0	5	9	L	94	92	89	22	77	76	75
Sandusky CO.....	41 3	606	- 2	4	8	M	92	90	87	21	76	75	74
Springfield.....	40 0	1020	- 3	3	7	M	93	90	88	21	77	76	75
Steubenville.....	40 2	992	- 2	4	9	M	91	89	86	22	76	75	74
Toledo AP.....	41 4	676r	- 5	1	5	M	92	90	87	25	77	75	74
Warren.....	41 2	900	- 6	0	4	M	90	88	85	23	75	74	73
Wooster.....	40 5	1030	- 7	- 1	3	M	90	88	85	22	76	75	74
Youngstown AP.....	41 2	1178	- 5	1	6	M	89	86	84	23	75	74	73
Zanesville AP.....	40 0	881	- 7	- 1	3	M	92	89	87	23	77	76	75
<b>OKLAHOMA</b>													
Ada.....	34 5	1015	6	12	16	H	102	100	98	23	79	78	77
Altus AFB.....	34 4	1390	7	14	18	H	103	101	99	25	77	76	75
Ardmore.....	34 2	880	9	15	19	H	103	101	99	23	79	78	77
Bartlesville.....	36 5	715	- 1	5	9	H	101	99	97	23	79	78	77
Chickasha.....	35 0	1085	5	12	16	H	103	101	99	24	77	76	75
Enid-Vance AFB.....	36 2	1287	3	10	14	H	103	100	98	24	78	77	76
Lawton AP.....	34 3	1108	6	13	16	H	103	101	98	24	78	77	76
McAlester.....	34 5	760	7	13	17	H	102	100	98	23	79	78	77
Muskogee AP.....	35 4	610	6	12	16	M	102	99	96	23	79	78	77
Norman.....	35 1	1109	5	11	15	H	101	99	97	24	78	77	76
Oklahoma City AP.....	35 2	1280	4	11	15	H	100	97	95	23	78	77	76
Ponca City.....	36 4	996	1	8	12	H	102	100	97	24	78	77	76
Seminole.....	35 2	865	6	12	16	H	102	100	98	23	78	77	76
Stillwater.....	36 1	884	2	9	13	H	101	99	97	24	78	77	76
Tulsa AP.....	36 1	650	4	12	16	H	102	99	96	22	79	78	77
Woodward.....	36 3	1900	- 3	4	8	H	103	101	98	26	76	74	73
<b>OREGON</b>													
Albany.....	44 4	224	17	23	27	VL	91	88	84	31	69	67	65
Astoria AP.....	46 1	8	22	27	30	M	79	76	72	16	61	60	59
Baker AP.....	44 5	3368	-10	- 3	1	VL	94	92	89	30	66	65	63
Bend.....	44 0	3599	- 7	0	4	VL	89	87	84	33	64	62	61
Corvallis.....	44 3	221	17	23	27	VL	91	88	84	31	69	67	65
Eugene AP.....	44 1	364	16	22	26	VL	91	88	84	31	69	67	65
Grants Pass.....	42 3	925	16	22	26	VL	94	92	89	33	68	66	65
Klamath Falls AP.....	42 1	4091	- 5	1	5	VL	89	87	84	36	63	62	61
Medford AP.....	42 2	1298	15	21	23	VL	98	94	91	35	70	68	66
Pendleton AP.....	45 4	1492	- 2	3	10	VL	97	94	91	29	66	65	63
Portland AP.....	45 4	21	17	21	24	L	89	85	81	23	69	67	66
Portland CO.....	45 3	57	21	26	29	L	91	88	84	21	69	68	67
Roseburg AP.....	43 1	505	19	25	29	VL	93	91	88	30	69	67	65
Salem AP.....	45 0	195	15	21	25	VL	92	88	84	31	69	67	66
The Dalles.....	45 4	102	7	13	17	VL	93	91	88	28	70	68	67
<b>PENNSYLVANIA</b>													
Allentown AP.....	40 4	376	- 2	3	5	M	92	90	87	22	77	75	74
Altoona CO.....	40 2	1468	- 4	1	5	L	89	87	84	23	74	73	72
Butler.....	40 4	1100	- 8	- 2	2	L	91	89	86	22	75	74	73
Chambersburg.....	40 0	640	0	5	9	L	94	92	89	23	76	75	74
Erie AP.....	42 1	732	1	7	11	M	88	85	82	18	76	74	73
Harrisburg AP.....	40 1	335	- 4	9	13	L	92	89	86	21	76	75	74
Johnstown.....	40 2	1214	- 4	1	5	L	91	87	85	23	74	73	72
Lancaster.....	40 1	255	- 3	2	6	L	92	90	87	22	77	76	75
Meadville.....	41 4	1065	- 6	0	4	M	88	86	83	21	75	73	72
New Castle.....	41 0	825	- 7	- 1	4	M	91	89	86	23	75	74	73

Climatic Conditions for United States and Canada (Continued)\*.a

Col. 1 State and Station <sup>b</sup>	Col. 2 Latitude <sup>c</sup>	Col. 3 Elev. <sup>d</sup> Ft	Winter				Summer						
			Col. 4			Col. 5 Coinci- dent Wind Ve- locity <sup>e</sup>	Col. 6 Design Dry-Bulb			Col. 7 Out- door Daily Range <sup>f</sup>	Col. 8 Design Wet-Bulb		
			Median of Annual Ex- tremes	99%	97½%		1%	2½%	5%		1%	2½%	5%
<b>PENNSYLVANIA (continued)</b>													
Philadelphia AP.....	39 5	7	7	11	15	M	93	90	87	21	78	77	76
Pittsburgh AP.....	40 3	1137	- 1	5	9	M	90	87	85	22	75	74	73
Pittsburgh CO.....	40 3	749r	1	7	11	M	90	88	85	19	75	74	73
Reading CO.....	40 2	226	1	6	9	M	92	90	87	19	77	76	75
Scranton/Wilkes-Barre.....	41 2	940	- 3	2	6	L	89	87	84	19	75	74	73
State College.....	40 5	1175	- 3	2	6	L	89	87	84	23	74	73	72
Sunbury.....	40 5	480	- 2	3	7	L	91	89	86	22	76	75	74
Uniontown.....	39 5	1040	- 1	4	8	L	90	88	85	22	75	74	73
Warren.....	41 5	1280	- 8	- 3	1	L	89	87	84	24	75	73	72
West Chester.....	40 0	440	- 4	9	13	M	92	90	87	20	77	76	75
Williamsport AP.....	41 1	527	- 5	1	5	L	91	89	86	23	76	75	74
York.....	40 0	390	- 1	4	8	L	93	91	88	22	77	76	75
<b>RHODE ISLAND</b>													
Newport.....	41 3	20	1	5	11	H	86	84	81	16	75	74	73
Providence AP.....	41 4	55	0	6	10	M	89	86	83	19	76	75	74
<b>SOUTH CAROLINA</b>													
Anderson.....	34 3	764	13	18	22	L	96	94	91	21	77	76	75
Charleston AFB.....	32 5	41	19	23	27	L	94	92	90	18	81	80	79
Charleston CO.....	32 5	9	23	26	30	L	95	93	90	13	81	80	79
Columbia AP.....	34 0	217	16	20	23	L	98	96	94	22	79	79	78
Florence AP.....	34 1	146	16	21	25	L	96	94	92	21	80	79	78
Georgetown.....	33 2	14	19	23	26	L	93	91	88	18	81	80	79
Greenville AP.....	34 5	957	14	19	23	L	95	93	91	21	77	76	75
Greenwood.....	34 1	671	15	19	23	L	97	95	92	21	78	77	76
Orangeburg.....	33 3	244	17	21	25	L	97	95	92	20	80	79	78
Rock Hill.....	35 0	470	13	17	21	L	97	95	92	20	78	77	76
Spartanburg AP.....	35 0	816	13	18	22	L	95	93	90	20	77	76	75
Sumter-Shaw AFB.....	34 0	291	18	23	26	L	96	94	92	21	80	79	78
<b>SOUTH DAKOTA</b>													
Aberdeen AP.....	45 3	1296	-29	-22	-18	L	95	92	89	27	77	75	74
Brookings.....	44 2	1642	-26	-19	-15	M	93	90	87	25	77	75	74
Huron AP.....	44 3	1282	-24	-16	-12	L	97	93	90	28	77	75	74
Mitchell.....	43 5	1346	-22	-15	-11	M	96	94	91	28	77	76	74
Pierre AP.....	44 2	1718r	-21	-13	- 9	M	98	96	93	29	76	74	73
Rapid City AP.....	44 0	3165	-17	- 9	- 6	M	96	94	91	28	72	71	69
Sioux Falls AP.....	43 4	1420	-21	-14	-10	M	95	92	89	24	77	75	74
Watertown AP.....	45 0	1746	-27	-20	-16	L	93	90	87	26	76	74	73
Yankton.....	43 0	1280	-18	-11	- 7	M	96	94	91	25	78	76	75
<b>TENNESSEE</b>													
Athens.....	33 3	940	10	14	18	L	96	94	91	22	77	76	75
Bristol-Tri City AP.....	36 3	1519	-1	11	16	L	92	90	88	22	76	75	74
Chattanooga AP.....	35 0	670	11	15	19	L	97	94	92	22	78	78	77
Clarksville.....	36 4	470	6	12	16	L	98	96	94	21	79	78	77
Columbia.....	35 4	690	8	13	17	L	97	95	93	21	79	78	77
Dyersburg.....	36 0	334	7	13	17	L	98	96	94	21	80	79	78
Greenville.....	35 5	1320	5	10	14	L	93	91	88	22	76	75	74
Jackson AP.....	35 4	413	8	14	17	L	97	95	94	21	80	79	78
Knoxville AP.....	35 5	980	9	13	17	L	95	92	90	21	77	76	75
Memphis AP.....	35 0	263	11	17	21	L	98	96	94	21	80	79	78
Murfreesboro.....	35 5	608	7	13	17	L	97	94	92	22	79	78	77
Nashville AP.....	36 1	577	6	12	16	L	97	95	92	21	79	78	77
Tulahoma.....	35 2	1075	7	13	17	L	96	94	92	22	79	78	77
<b>TEXAS</b>													
Abilene AP.....	32 3	1759	12	17	21	M	101	99	97	22	76	75	74
Alice AP.....	27 4	180	26	30	34	M	101	99	97	20	81	80	79
Amarillo AP.....	35 1	3607	2	8	12	M	98	96	93	26	72	71	70
Austin AP.....	30 2	597	19	25	29	M	101	98	96	22	79	78	77
Bay City.....	29 0	52	25	29	33	M	95	93	91	16	81	80	79
Beaumont.....	30 0	18	25	29	33	M	96	94	93	19	81	80	79
Beeville.....	28 2	225	24	28	32	M	99	97	96	18	81	80	79
Big Spring AP.....	32 2	2537	12	18	22	M	100	98	96	26	75	73	72
Brownsville AP.....	25 5	16	32	36	40	M	94	92	91	18	80	80	79
Brownwood.....	31 5	1435	15	20	25	M	102	100	98	22	76	75	74
Bryan AP.....	30 4	275	22	27	31	M	100	98	96	20	79	78	78

Climatic Conditions for United States and Canada (Continued)\*.a

Col. 1 State and Station <sup>b</sup>	Col. 2 Latitude <sup>c</sup>	Col. 3 Elev., <sup>d</sup> Ft	Winter				Summer						
			Col. 4			Col. 5 Coinci- dent Wind Ve- locity <sup>e</sup>	Col. 6 Design Dry-Bulb			Col. 7 Out- door Daily Range <sup>f</sup>	Col. 8 Design Wet-Bulb		
			Median of Annual Ex- tremes	99%	97½%		1%	2½%	5%		1%	2½%	5%
<b>TEXAS (continued)</b>													
Corpus Christi AP.....	27 5	43	28	32	36	M	95	93	91	19	81	80	80
Corsicana.....	32 0	425	16	21	25	M	102	100	98	21	79	78	77
Dallas AP.....	32 5	481	14	19	24	H	101	99	97	20	79	78	78
Del Rio, Laughlin AFB.....	29 2	1072	24	28	31	M	101	99	98	24	79	77	76
Denton.....	33 1	655	12	18	22	H	102	100	98	22	79	78	77
Eagle Pass.....	28 5	743	23	27	31	L	106	104	102	24	80	79	78
El Paso AP.....	31 5	3918	16	21	25	L	100	98	96	27	70	69	68
Fort Worth AP.....	32 5	544r	14	20	24	H	102	100	98	22	79	78	77
Galveston AP.....	29 2	5	28	32	36	M	91	89	88	10	82	81	81
Greenville.....	33 0	575	13	19	24	H	101	99	97	21	79	78	78
Harlingen.....	26 1	37	30	34	38	M	96	95	94	19	80	80	79
Houston AP.....	29 4	50	23	28	32	M	96	94	92	18	80	80	79
Houston CO.....	29 5	158r	24	29	33	M	96	94	92	18	80	80	79
Huntsville.....	30 4	494	22	27	31	M	99	97	96	20	80	79	78
Killeen-Gray AFB.....	31 0	1021	17	22	26	M	100	99	97	22	78	77	76
Lamesa.....	32 5	2965	7	14	18	M	100	98	96	26	74	73	72
Laredo AFB.....	27 3	503	29	32	36	L	103	101	100	23	79	78	78
Longview.....	32 2	345	16	21	25	M	100	98	96	20	81	80	79
Lubbock AP.....	33 4	3243	4	11	15	M	99	97	94	26	73	72	71
Lufkin AP.....	31 1	286	19	24	28	M	98	96	95	20	81	80	79
McAllen.....	26 1	122	30	34	38	M	102	100	98	21	80	79	78
Midland AP.....	32 0	2815r	13	19	23	M	100	98	96	26	74	73	72
Mineral Wells AP.....	32 5	934	12	18	22	H	102	100	98	22	78	77	76
Palestine CO.....	31 5	580	16	21	25	M	99	97	96	20	80	79	78
Pampa.....	35 3	3230	0	7	11	M	100	98	95	26	73	72	71
Pecos.....	31 2	2580	10	15	19	L	102	100	97	27	72	71	70
Plainview.....	34 1	3400	3	10	14	M	100	98	95	26	73	72	71
Port Arthur AP.....	30 0	16	25	29	33	M	94	92	91	19	81	80	80
San Angelo, Goodfellow AFB.....	31 2	1878	15	20	25	M	101	99	97	24	76	75	74
San Antonio AP.....	29 3	792	22	25	30	L	99	97	96	19	77	77	76
Sherman-Perrin AFB.....	33 4	763	12	18	23	H	101	99	97	22	79	78	77
Snyder.....	32 4	2325	9	15	19	M	102	100	97	26	75	74	73
Temple.....	31 1	675	18	23	27	M	101	99	97	22	79	78	77
Tyler AP.....	32 2	527	15	20	24	M	99	97	96	21	80	79	78
Vernon.....	34 1	1225	7	14	18	H	103	101	99	24	77	76	75
Victoria AP.....	28 5	104	24	28	32	M	98	96	95	18	80	79	79
Waco AP.....	31 4	500	16	21	26	M	101	99	98	22	79	78	78
Wichita Falls AP.....	34 0	994	9	15	19	H	103	100	98	24	77	76	75
<b>UTAH</b>													
Cedar City AP.....	37 4	5613	-10	- 1	6	VL	94	91	89	32	65	64	62
Logan.....	41 4	4775	- 7	3	7	VL	93	91	89	33	66	65	63
Moab.....	38 5	3965	2	12	16	VL	100	98	95	30	66	65	64
Ogden CO.....	41 1	4400	- 3	7	11	VL	94	92	89	33	66	65	64
Price.....	39 4	5580	- 7	3	7	L	93	91	88	33	65	64	63
Provo.....	40 1	4470	- 6	2	6	L	96	93	91	32	67	66	65
Richfield.....	38 5	5300	-10	- 1	3	L	94	92	89	34	66	65	64
St. George CO.....	37 1	2899	13	22	26	VL	104	102	99	33	71	70	69
Salt Lake City AP.....	40 5	4220	- 2	5	9	L	97	94	92	32	67	66	65
Vernal AP.....	40 3	5280	-20	-10	- 6	VL	90	88	84	32	64	63	62
<b>VERMONT</b>													
Barre.....	44 1	1120	-23	-17	-13	L	86	84	81	23	73	72	70
Burlington AP.....	44 3	331	-18	-12	- 7	M	88	85	83	23	74	73	71
Rutland.....	43 3	620	-18	-12	- 8	L	87	85	82	23	74	73	71
<b>VIRGINIA</b>													
Charlottesville.....	38 1	870	7	11	15	L	93	90	88	23	79	77	76
Danville AP.....	36 3	590	9	13	17	L	95	92	90	21	78	77	76
Fredericksburg.....	38 2	50	6	10	14	M	94	92	89	21	79	78	76
Harrisonburg.....	38 3	1340	0	5	9	L	92	90	87	23	78	77	76
Lynchburg AP.....	37 2	947	10	15	19	L	94	92	89	21	77	76	75
Norfolk AP.....	36 5	26	18	20	23	M	94	91	89	18	79	78	78
Petersburg.....	37 1	194	10	15	18	L	96	94	91	20	80	79	78



Climatic Conditions for United States and Canada (Continued)\*.a

Col. 1 State and Station <sup>b</sup>	Col. 2 Latitude <sup>c</sup>	Col. 2 Elev. <sup>d</sup> Ft	Winter				Summer						
			Median of Annual Ex- tremes	Col. 4		Col. 5 Coinci- dent Wind Ve- locity <sup>e</sup>	Col. 6 Design Dry-Bulb			Col. 6 Out- door Daily Range <sup>f</sup>	Col. 8 Design Wet-Bulb		
				99%	97½%		1%	2½%	5%		1%	2½%	5%
<b>VIRGINIA (continued)</b>													
Richmond AP.....	37 3	162	10	14	18	L	96	93	91	21	79	78	77
Roanoke AP.....	37 2	1174r	9	15	18	L	94	91	89	23	76	75	74
Staunton.....	38 2	1480	3	8	12	L	92	90	87	23	78	77	75
Winchester.....	39 1	750	1	6	10	L	94	92	89	21	78	76	75
<b>WASHINGTON</b>													
Aberdeen.....	47 0	12	19	24	27	M	83	80	77	16	62	61	60
Bellingham AP.....	48 5	150	8	14	18	L	76	74	71	19	67	65	63
Bremerton.....	47 3	162	17	24	29	L	85	81	77	20	68	66	65
Ellensburg AP.....	47 0	1729	- 5	2	6	VL	91	89	86	34	67	65	63
Everett-Paine AFB.....	47 5	598	13	19	24	L	82	78	74	20	67	65	63
Kennewick.....	46 0	392	4	11	15	VL	98	96	93	30	69	68	66
Longview.....	46 1	12	14	20	24	L	88	86	83	30	68	66	65
Moses Lake, Larson AFB.....	47 1	1183	-14	- 7	- 1	VL	96	93	90	32	68	66	65
Olympia AP.....	47 0	190	15	21	25	L	85	83	80	32	67	65	63
Port Angeles.....	48 1	99	20	26	29	M	75	73	70	18	60	58	57
Seattle-Boeing Fld.....	47 3	14	17	23	27	L	82	80	77	24	67	65	64
Seattle CO.....	47 4	14	22	28	32	L	81	79	76	19	67	65	64
Seattle-Tacoma AP.....	47 3	386	14	20	24	L	85	81	77	22	66	64	63
Spokane AP.....	47 4	2357	- 5	- 2	4	VL	93	90	87	28	66	64	63
Tacoma-McChord AFB.....	47 1	350	14	20	24	L	85	81	78	22	68	66	64
Walla Walla AP.....	46 1	1185	5	12	16	VL	98	96	93	27	69	68	66
Wenatchee.....	47 2	634	- 2	5	9	VL	95	92	89	32	68	66	64
Yakima AP.....	46 3	1061	- 1	6	10	VL	94	92	89	36	69	67	65
<b>WEST VIRGINIA</b>													
Beckley.....	37 5	2330	- 4	0	6	L	91	88	86	22	74	73	72
Bluefield AP.....	37 2	2850	1	6	10	L	88	86	83	22	74	73	72
Charleston AP.....	38 2	939	1	9	14	L	92	90	88	20	76	75	74
Clarksburg.....	39 2	977	- 2	3	7	L	92	90	87	21	76	75	74
Elkins AP.....	38 5	1970	- 4	1	5	L	87	84	82	22	74	73	72
Huntington CO.....	38 2	565r	4	10	14	L	95	93	91	22	77	76	75
Martinsburg AP.....	39 2	537	1	6	10	L	96	94	91	21	78	77	76
Morgantown AP.....	39 4	1245	- 2	3	7	L	90	88	85	22	76	74	73
Parkersburg CO.....	39 2	615r	2	8	12	L	93	91	88	21	77	76	75
Wheeling.....	40 1	659	0	5	9	L	91	89	86	21	76	75	74
<b>WISCONSIN</b>													
Appleton.....	44 2	742	-16	-10	- 6	M	89	87	84	23	75	74	72
Ashland.....	46 3	650	-27	-21	-17	L	85	83	80	23	73	71	69
Beloit.....	42 3	780	-13	- 7	- 3	M	92	90	87	24	77	76	75
Eau Claire AP.....	44 5	888	-21	-15	-11	L	90	88	85	23	76	74	72
Fond du Lac.....	43 5	760	-17	-11	- 7	M	89	87	84	23	76	74	73
Green Bay AP.....	44 3	683	-16	-12	- 7	M	88	85	82	23	75	73	72
La Crosse AP.....	43 5	652	-18	-12	- 8	M	90	88	85	22	78	76	75
Madison AP.....	43 1	858	-13	- 9	- 5	M	92	88	85	22	77	75	73
Manitowoc.....	44 1	660	-11	- 5	- 1	M	88	86	83	21	75	74	72
Marinette.....	45 0	605	-14	- 8	- 4	M	88	86	83	20	74	72	70
Milwaukee AP.....	43 0	672	-11	- 6	- 2	M	90	87	84	21	77	75	73
Racine.....	42 4	640	-10	- 4	0	M	90	88	85	21	77	75	73
Sheboygan.....	43 4	648	-10	- 4	0	M	89	87	84	20	76	74	72
Stevens Point.....	44 3	1079	-22	-16	-12	M	89	87	84	23	75	73	71
Waukesha.....	43 0	860	-12	- 6	- 2	M	91	89	86	22	77	75	74
Wausau AP.....	44 6	1196	-24	-18	-14	M	89	86	83	23	74	72	70
<b>WYOMING</b>													
Casper AP.....	42 5	5319	-20	-11	- 5	L	92	90	87	31	63	62	60
Cheyenne AP.....	41 1	6126	-15	- 6	- 2	M	89	86	83	30	63	62	61
Cody AP.....	44 3	5090	-23	-13	- 9	L	90	87	84	32	61	60	59
Evanston.....	41 2	6860	-22	-12	- 8	VL	84	82	79	32	58	57	56
Lander AP.....	42 5	5563	-26	-16	-12	VL	92	90	87	32	63	62	60
Laramie AP.....	41 2	7266	-17	- 6	- 2	M	82	80	77	28	61	59	58
Newcastle.....	43 5	4480	-18	- 9	- 5	M	92	89	86	30	68	67	66
Rawlins.....	41 5	6736	-24	-15	-11	L	86	84	81	40	62	61	60
Rock Springs AP.....	41 4	6741	-16	- 6	- 1	VL	86	84	82	32	58	57	56
Sheridan AP.....	44 5	3942	-21	-12	- 7	L	95	92	89	32	67	65	64
Torrington.....	42 0	4098	-20	-11	- 7	M	94	92	89	30	68	67	66

Climatic Conditions for United States and Canada (Continued)\*.a

CANADA													
Col. 1 Province and Station <sup>b</sup>	Col. 2 Latitude <sup>c</sup>	Col. 3 Elev. <sup>d</sup> Ft	Winter				Summer						
			Col. 4			Col. 5 Coinci- dent Wind Velo- city <sup>e</sup>	Col. 6 Design Dry-Bulb			Col. 7 Out- door Daily Range <sup>f</sup>	Col. 8 Design Wet-Bulb		
			Aver- age Annual Mini- mum	99%	97½%		1%	2½%	5%		1%	2½%	5%
<b>ALBERTA</b>													
Calgary AP.....	51 1	3540	-30	-29	-25	M	87	85	82	26	66	64	63
Edmonton AP.....	53 3	2219	-30	-29	-26	VL	86	83	80	23	69	67	65
Grande Prairie AP.....	55 1	2190	-44	-43	-37	VL	84	81	78	23	66	64	63
Jasper CO.....	52 5	3480	-38	-32	-28	VL	87	84	81	28	66	64	63
Lethbridge AP.....	49 4	3018	-31	-31	-24	M	91	88	85	28	68	66	64
McMurray AP.....	56 4	1216	-44	-42	-39	VL	87	84	81	28	69	67	65
Medicine Hat AP.....	50 0	2365	-33	-30	-26	M	96	93	90	28	72	69	67
Red Deer AP.....	52 1	2965	-38	-33	-28	VL	88	86	83	25	67	65	64
<b>BRITISH COLUMBIA</b>													
Dawson Creek.....	55 5	2200	-47	-40	-35	L	84	81	78	25	66	64	63
Fort Nelson AP.....	58 5	1230	-43	-44	-41	VL	87	84	81	23	66	64	63
Kamloops CO.....	50 4	1150	-15	-16	-10	VL	97	94	91	31	71	69	68
Nanaimo CO.....	49 1	100	16	17	20	VL	81	78	75	20	66	64	62
New Westminster CO.....	49 1	50	12	15	19	VL	86	84	82	20	68	66	65
Penticton AP.....	49 3	1121	0	- 1	3	L	94	91	88	31	71	69	68
Prince George AP.....	53 5	2218	-38	-37	-31	VL	85	82	79	26	68	65	63
Prince Rupert CO.....	54 2	170	9	11	15	L	73	71	69	13	62	60	59
Trail.....	49 1	1400	- 3	- 2	3	VL	94	91	88	30	70	68	67
Vancouver AP.....	49 1	16	13	15	19	L	80	78	76	17	68	66	65
Victoria CO.....	48 3	228	20	20	23	M	80	76	72	16	64	62	60
<b>MANITOBA</b>													
Brandon CO.....	49 5	1200	-36	-29	-26	M	90	87	84	26	75	73	71
Churchill AP.....	58 5	115	-43	-40	-38	H	79	75	72	18	68	66	63
Dauphin AP.....	51 1	999	-35	-29	-26	M	89	86	83	24	74	72	70
Flin Flon CO.....	54 5	1098	-38	-40	-36	L	85	81	78	19	71	69	67
Portage la Prairie AP.....	49 5	867	-28	-25	-22	M	90	87	84	22	75	74	72
The Pas AP.....	54 0	894	-41	-35	-32	M	85	81	78	20	73	71	69
Winnipeg AP.....	49 5	786	-31	-28	-25	M	90	87	84	23	75	74	72
<b>NEW BRUNSWICK</b>													
Campbellton CO.....	48 0	25	-20	-18	-14	L	87	84	81	20	74	71	69
Chatham AP.....	47 0	112	-17	-15	-10	M	90	87	84	22	74	71	69
Edmundston CO.....	47 2	500	-29	-20	-16	M	84	81	78	21	75	72	70
Fredericton AP.....	45 5	74	-19	-16	-10	L	89	86	83	23	73	70	68
Moncton AP.....	46 1	248	-16	-12	- 7	H	88	85	82	21	74	71	69
Saint John AP.....	45 2	352	-15	-12	- 7	M	81	79	77	18	71	68	66
<b>NEWFOUNDLAND</b>													
Corner Brook CO.....	49 0	40	- 9	-10	- 5	H	84	81	79	18	69	68	66
Gander AP.....	49 0	482	- 5	- 5	- 1	H	85	82	79	20	69	68	66
Goose Bay AP.....	53 2	144	-28	-27	-25	M	86	81	77	18	69	67	65
St. John's AP.....	47 4	463	1	2	6	H	79	77	75	17	69	68	66
Stephenville.....	48 3	44	- 4	- 6	- 1	H	79	76	74	13	69	68	66
<b>NORTHWEST TERRITORIES</b>													
Fort Smith AP.....	60 0	665	-51	-49	-46	VL	85	83	80	25	67	65	64
Frobisher Bay AP.....	63 5	68	-45	-45	-42	H	63	59	56	14			
Inuvik.....	68 2	75	-54	-50	-48	VL	80	77	75	23	63	61	60
Resolute AP.....	74 4	209	-52	-49	-47	M	54	51	49	10			
Yellowknife AP.....	62 3	682	-51	-49	-47	VL	78	76	74	17	65	63	62
<b>NOVA SCOTIA</b>													
Amherst.....	45 5	63	-15	-10	- 5	H	85	82	79	21	72	70	68
Halifax AP.....	44 4	136	- 4	0	4	H	83	80	77	16	69	68	67
Kentville CO.....	45 0	50	- 8	- 4	0	M	86	83	80	23	72	70	69
New Glasgow.....	45 4	317	-16	-10	- 5	H	84	81	79	21	72	70	68
Sydney AP.....	46 1	197	- 3	0	5	H	84	82	80	20	72	70	68
Truro CO.....	45 2	77	-17	-12	- 7	M	84	81	79	22	72	70	69
Yarmouth AP.....	43 5	136	2	5	9	H	76	73	71	15	69	68	67
<b>ONTARIO</b>													
Bellefonte CO.....	44 1	250	-15	-11	- 7	M	89	86	84	21	77	75	73
Chatham CO.....	42 2	600	- 1	3	6	M	92	90	88	20	77	75	74
Cornwall.....	45 0	210	-22	-14	- 9	M	89	86	84	23	77	75	74
Fort William AP.....	48 2	644	-31	-27	-23	L	86	83	80	23	72	70	68
Hamilton.....	43 2	303	- 2	0	3	M	91	88	86	21	77	75	73
Kapuskasing AP.....	49 3	752	-37	-31	-28	M	87	84	81	23	73	71	69
Kenora AP.....	49 5	1345	-33	-31	-28	M	86	83	80	20	75	73	71
Kingston CO.....	44 2	300	-16	-10	- 7	M	85	82	80	20	77	75	73



Climatic Conditions for United States and Canada (Concluded)\*.a

Col. 1 Province and Station <sup>b</sup>	Col. 2 Latitude <sup>c</sup>	Col. 3 Elev. <sup>d</sup> Ft	Winter				Summer						
			Col. 4			Col. 5 Coincident Wind Velocity <sup>e</sup>	Col. 6 Design Dry-Bulb			Col. 7 Out- door Daily Range <sup>f</sup>	Col. 8 Design Wet-Bulb		
			Average Annual Minimum	99%	97½%		1%	2½%	5%		1%	2½%	5%
<b>ONTARIO (continued)</b>													
Kitchener.....	43 3	1125	-11	-3	1	M	88	85	83	24	76	75	74
London AP.....	43 0	912	-9	-1	3	M	90	88	86	22	76	75	74
North Bay AP.....	46 2	1210	-27	-21	-17	M	87	84	82	18	71	70	69
Oshawa.....	43 5	370	-11	-5	-2	M	90	87	85	21	77	75	73
Ottawa AP.....	45 2	339	-21	-17	-13	M	90	87	84	21	75	74	73
Owen Sound.....	44 3	597	-9	-5	-1	M	87	84	82	21	74	72	71
Peterborough CO.....	44 2	648	-20	-13	-9	M	90	87	85	22	76	74	73
St. Catharines CO.....	43 1	325	-1	2	5	M	91	88	86	20	77	75	73
Sarnia.....	43 0	625	-6	2	6	M	92	90	88	19	76	74	73
Sault Ste. Marie CO.....	46 3	675	-21	-20	-15	M	88	85	83	22	72	70	68
Sudbury.....	46 3	850	-25	-20	-15	VL	89	86	84	25	72	70	69
Timmins CO.....	48 3	1100	-37	-33	-28	M	90	87	84	24	73	71	69
Toronto AP.....	43 4	578	-10	-3	1	M	90	87	85	22	77	75	73
Windsor AP.....	42 2	637	-1	4	7	M	92	90	88	20	77	75	74
<b>PRINCE EDWARD ISLAND</b>													
Charlottetown AP.....	46 2	186	-11	-6	-3	H	84	81	79	16	72	70	68
Summerside AP.....	46 3	78	-10	-8	-3	H	84	81	79	16	72	70	68
<b>QUEBEC</b>													
Bagotville.....	48 2	536	-35	-26	-22	VL	88	84	81	20	72	71	69
Chicoutimi CO.....	48 3	150	-31	-24	-20	VL	87	83	80	20	72	71	69
Drummondville CO.....	45 5	270	-26	-18	-13	M	88	85	82	22	76	74	72
Granby.....	45 2	550	-23	-17	-12	L	87	84	82	21	76	74	72
Hull.....	45 3	200	-21	-17	-13	M	90	87	84	21	75	74	73
Mégantic AP.....	45 4	1362	-27	-20	-16	M	84	81	78	19	75	73	71
Montréal AP.....	45 3	98	-20	-16	-10	M	88	86	84	18	76	74	73
Québec AP.....	46 5	245	-25	-19	-13	M	86	82	79	21	75	73	71
Rimouski.....	48 3	117	-18	-16	-12	H	78	74	71	18	71	69	68
St. Jean.....	45 2	129	-21	-15	-10	M	87	85	83	20	76	74	73
St. Jérôme.....	45 5	310	-30	-18	-13	L	87	84	82	23	76	74	73
Sept Îles AP.....	50 1	190	-29	-27	-22	L	80	78	75	17	66	64	63
Shawinigan.....	46 3	306	-27	-20	-15	L	88	85	83	21	76	74	72
Sherbrooke CO.....	45 2	595	-25	-18	-13	L	87	84	81	20	75	73	71
Theftford Mines.....	46 0	1020	-25	-19	-14	M	86	83	80	22	75	73	71
Trois Rivières CO.....	46 2	200	-30	-18	-13	M	88	85	82	23	76	74	72
Val d'Or AP.....	48 0	1108	-37	-31	-27	L	88	85	82	22	72	71	69
Valleyfield.....	45 2	150	-20	-14	-9	M	87	85	83	21	76	74	73
<b>SASKATCHEWAN</b>													
Estevan AP.....	49 0	1884	-32	-30	-25	M	93	89	86	25	75	73	71
Moose Jaw AP.....	50 2	1857	-33	-32	-27	M	93	89	86	27	73	71	69
North Battleford AP.....	52 5	1796	-33	-33	-29	L	90	86	83	25	71	69	67
Prince Albert AP.....	53 1	1414	-45	-41	-35	VL	88	84	81	25	72	70	68
Regina AP.....	50 3	1884	-38	-34	-29	M	92	88	85	27	73	71	69
Saskatoon AP.....	52 1	1645	-37	-34	-30	M	90	86	83	25	71	69	67
Swift Current AP.....	50 2	2677	-31	-29	-25	M	93	89	86	24	72	70	68
Yorkton AP.....	51 2	1653	-38	-33	-28	M	89	85	82	23	74	72	70
<b>YUKON TERRITORY</b>													
Whitehorse AP.....	60 4	2289	-45	-45	-42	VL	78	75	72	22	62	60	59

\* Data for U. S. stations extracted from *Evaluated Weather Data for Cooling Equipment Design, Addendum No. 1, Winter and Summer Data*, with the permission of the publisher, Fluor Products Company, Inc., Box 1267, Santa Rosa, California.

<sup>a</sup> Data compiled from official weather stations, where hourly weather observations are made by trained observers, and from other sources. Table 1 prepared by ASHRAE Technical Committee 2.2, Weather Data and Design Conditions. Percentage of winter design data show the percent of 3-month period, December through February. Canadian data are based on January only. Percentage of summer design data show the percent of 4-month period, June through September. Canadian data are based on July only. Also see References 1 to 7.

<sup>b</sup> When airport temperature observations were used to develop design data, "AP" follows station name, and "AFB" follows Air Force Bases. Data for stations followed by "CO" came from office locations within an urban area and generally reflect an influence of the surrounding area. Stations without designation can be considered semirural and may be directly compared with most airport data.

<sup>c</sup> Latitude is given to the nearest 10 minutes, for use in calculating solar loads. For example, the latitude for Anniston, Alabama is given as 33 4, or 33°40'.

<sup>d</sup> Elevations are ground elevations for each station as of 1964. Temperature readings are generally made at an elevation of 5 ft above ground, except for locations marked r, indicating roof exposure of thermometer.

<sup>e</sup> Coincident wind velocities derived from approximately coldest 600 hours out of 20,000 hours of December through February data per station. Also see References 5 and 6. The four classifications are:

VL = Very Light, 70 percent or more of cold extreme hours ≤ 7 mph. M = Moderate, 50 to 74 percent cold extreme hours > 7 mph.  
L = Light, 50 to 69 percent cold extreme hours ≤ 7 mph. H = High, 75 percent or more cold extreme hours > 7 mph., and 50 percent are > 12 mph.

<sup>f</sup> The difference between the average maximum and average minimum temperatures during the warmest month.

† More detailed data on Arizona, California, and Nevada may be found in *Recommended Design Temperatures, Northern California*, published by the Golden Gate Chapter; and *Recommended Design Temperatures, Southern California, Arizona, Nevada*, published by the Southern California Chapter.



Climatic Conditions for Other Foreign Countries

Col. 1 Country and Station	Col. 2 Latitude and Longitude	Col. 3 Elevation, Ft	Winter			Summer								
			Col. 4			Col. 5 Design Dry-Bulb			Col. 6 Out-door Daily Range F deg	Col. 7 Design Wet-Bulb				
			Mean of Annual Ex-tremes	99%	97½%	1%	2½%	5%		1%	2½%	5%		
ADEN														
Aden.....	12 50N/45 02E	10	63	68	70	102	100	98	11	83	82	82		
AFGHANISTAN														
Kabul.....	34 35N/69 12E	5955	2	6	9	98	96	93	32	66	65	64		
ALGERIA														
Algiers.....	36 46N/3 03E	194	38	43	45	95	92	89	14	77	76	75		
ARGENTINA														
Buenos Aires.....	34 35S/58 29W	89	27	32	34	91	89	86	22	77	76	75		
Córdoba.....	31 22S/64 15W	1388	21	28	32	100	96	93	27	76	75	74		
Tucuman.....	26 50S/65 10W	1401	24	32	36	102	99	96	23	76	75	74		
AUSTRALIA														
Adelaide.....	34 56S/138 35E	140	36	38	40	98	94	91	25	72	70	68		
Alice Springs.....	23 48S/133 53E	1795	28	34	37	104	102	100	27	75	74	72		
Brisbane.....	27 28S/153 02E	137	39	44	47	91	88	86	18	77	76	75		
Darwin.....	12 28S/130 51E	88	60	64	66	94	93	91	16	82	81	81		
Melbourne.....	37 49S/144 58E	114	31	35	38	95	91	86	21	71	69	68		
Perth.....	31 57S/115 51E	210	38	40	42	100	96	93	22	76	74	73		
Sydney.....	33 52S/151 12E	138	38	40	42	89	84	80	13	74	73	72		
AUSTRIA														
Vienna.....	48 15N/16 22E	644	2	6	11	88	86	83	16	71	69	67		
AZORES														
Lajes (Terceira).....	38 45N/27 05W	170	42	46	49	80	78	77	11	73	72	71		
BAHAMAS														
Nassau.....	25 05N/77 21W	11	55	61	63	90	89	88	13	80	80	79		
BELGIUM														
Brussels.....	50 48N/4 21E	328	13	15	19	83	79	77	19	70	68	67		
BERMUDA														
Kindley AFB.....	33 22N/64 41W	129	47	53	55	87	86	85	12	79	78	78		
BOLIVIA														
La Paz.....	16 30S/68 09W	12001	28	31	33	71	69	68	24	58	57	56		
BRAZIL														
Belem.....	1 27S/48 29W	42	67	70	71	90	89	87	19	80	79	78		
Belo Horizonte.....	19 56S/43 57W	3002	42	47	50	86	84	83	18	76	75	75		
Brasilia.....	15 52S/47 55W	3442	46	49	51	89	88	86	17	76	75	75		
Curitiba.....	25 25S/49 17W	3114	28	34	37	86	84	82	21	75	74	74		
Fortaleza.....	3 46S/38 33W	89	66	69	70	91	90	89	17	79	78	78		
Porto Alegre.....	30 02S/51 13W	33	32	37	40	95	92	89	20	76	76	75		
Recife.....	8 04S/34 53W	97	67	69	70	88	87	86	10	78	77	77		
Rio de Janeiro.....	22 55S/43 12W	201	56	58	60	94	92	90	11	80	79	78		
Salvador.....	13 00S/38 30W	154	65	67	68	88	87	86	12	79	79	78		
São Paulo.....	23 33S/46 38W	2608	36	42	46	86	84	82	18	75	74	74		
BRITISH HONDURAS														
Belize.....	17 31N/88 11W	17	55	60	62	90	90	89	13	82	82	81		
BULGARIA														
Sofia.....	42 42N/23 20E	1805	2	3	8	89	86	84	26	71	70	69		
BURMA														
Mandalay.....	21 59N/96 06E	252	50	54	56	104	102	101	30	81	80	80		
Rangoon.....	16 47N/96 09E	18	59	62	63	100	98	95	25	83	82	82		
CAMBODIA														
Phnom Penh.....	11 33N/104 51E	36	62	66	68	98	96	94	19	83	82	82		
CEYLON														
Colombo.....	6 54N/79 52E	24	65	69	70	90	89	88	15	81	80	80		
CHILE														
Punta Arenas.....	53 10S/70 54W	26	22	25	27	68	66	64	14	56	55	54		
Santiago.....	33 27S/70 42W	1706	27	32	35	90	89	88	32	71	70	69		
Valparaiso.....	33 01S/71 38W	135	39	43	46	81	79	77	16	67	66	65		
CHINA														
Chungking.....	29 33N/106 33E	755	34	37	39	99	97	95	18	81	80	79		
Shanghai.....	31 12N/121 26E	23	16	23	26	94	92	90	16	81	81	80		
COLOMBIA														
Baranquilla.....	10 59N/74 48W	44	66	70	72	95	94	93	17	83	82	82		
Bogotá.....	4 36N/74 05W	8406	42	45	46	72	70	69	19	60	59	58		
Cali.....	3 25N/76 30W	3189	53	57	58	84	82	79	15	70	69	68		
Medellin.....	6 13N/75 36W	4650	48	53	55	87	85	84	25	73	72	72		
CONGO														
Brazzaville.....	4 15S/15 15E	1043	54	60	62	93	92	91	21	81	81	80		
Kinasha (Leopoldville).....	4 20S/15 18E	1066	54	60	62	92	91	90	19	81	80	80		
Stanleyville.....	0 26N/15 14E	1370	65	67	68	92	91	90	19	81	80	80		

Climatic Conditions for Other Foreign Countries (Continued)

Col. 1 Country and Station	Col. 2 Latitude and Longitude	Col. 3 Elevation, Ft	Winter			Summer													
			Col. 4			Col. 5 Design Dry-Bulb			Col. 6 Out-door Daily Range F deg	Col. 7 Design Wet-Bulb									
			Mean of Annual Extremes	99%	97½%	1%	2½%	5%		1%	2½%	5%							
CUBA																			
Guantanamo Bay.....	19 54N/75 09W	21	60	64	66	94	93	92	16	82	81	80							
Havana.....	23 08N/82 21W	80	54	59	62	92	91	89	14	81	81	80							
CZECHOSLOVAKIA																			
Prague.....	50 05N/14 25E	662	3	4	9	88	85	83	16	66	65	64							
DENMARK																			
Copenhagen.....	55 41N/12 33E	43	11	16	19	79	76	74	17	68	66	64							
DOMINICAN REPUBLIC																			
Santo Domingo.....	18 29N/69 54W	57	61	63	65	92	90	88	16	81	80	80							
ECUADOR																			
Guayaquil.....	2 10S/79 53W	20	61	64	65	92	91	89	20	80	80	79							
Quito.....	0 13S/78 32W	9446	30	36	39	73	72	71	32	63	62	62							
EL SALVADOR																			
San Salvador.....	13 42N/89 13W	2238	51	54	56	98	96	95	32	77	76	75							
ETHIOPIA																			
Addis Ababa.....	9 02N/38 45E	7753	35	39	41	84	82	81	28	66	65	64							
Asmara.....	15 17N/38 55E	7628	36	40	42	83	81	80	27	65	64	63							
FINLAND																			
Helsinki.....	60 10N/24 57E	30	-11	-7	-1	77	74	72	14	66	65	63							
FRANCE																			
Lyon.....	45 42N/4 47E	938	-1	10	14	91	89	86	23	71	70	69							
Marseilles.....	43 18N/5 23E	246	23	25	28	90	87	84	22	72	71	69							
Nantes.....	47 15N/1 34W	121	17	22	26	86	83	80	21	70	69	67							
Nice.....	43 42N/7 16E	39	31	34	37	87	85	83	15	73	72	72							
Paris.....	48 49N/2 29E	164	16	22	25	89	86	83	21	70	68	67							
Strasbourg.....	48 35N/7 46E	465	9	11	16	86	83	80	20	70	69	67							
FRENCH GUIANA																			
Cayenne.....	4 56N/52 27W	20	69	71	72	92	91	90	17	83	83	82							
GERMANY																			
Berlin.....	52 27N/13 18E	187	6	7	12	84	81	78	19	68	67	66							
Hamburg.....	53 33N/9 58E	66	10	12	16	80	76	73	13	68	66	65							
Hannover.....	52 24N/9 40E	561	7	16	20	82	78	75	17	68	67	65							
Mannheim.....	49 34N/8 28E	359	2	8	11	87	85	82	18	71	69	68							
Munich.....	48 09N/11 34E	1729	-1	5	9	86	83	80	18	68	66	64							
GHANA																			
Accra.....	5 33N/0 12W	88	65	68	69	91	90	89	13	80	79	79							
GIBRALTAR																			
Gibraltar.....	36 09N/5 22W	11	38	42	45	92	89	86	14	76	75	74							
GREECE																			
Athens.....	37 58N/23 43E	351	29	33	36	96	93	91	18	72	71	71							
Thessaloniki.....	40 37N/22 57E	78	23	28	32	95	93	91	20	77	76	75							
GREENLAND																			
Narsarsuaq.....	61 11N/45 25W	85	-23	-12	-8	66	63	61	20	56	54	52							
GUATEMALA																			
Guatemala City.....	14 37N/90 31W	4855	45	48	51	83	82	81	24	69	68	67							
GUYANA																			
Georgetown.....	6 50N/58 12W	6	70	72	73	89	88	87	11	80	79	79							
HAITI																			
Port au Prince.....	18 33N/72 20W	121	63	65	67	97	95	93	20	82	81	80							
HONDURAS																			
Tegucigalpa.....	14 06N/87 13W	3094	44	47	50	89	87	85	28	73	72	71							
HONG KONG																			
Hong Kong.....	22 18N/114 10E	109	43	48	50	92	91	90	10	81	80	80							
HUNGARY																			
Budapest.....	47 31N/19 02E	394	8	10	14	90	86	84	21	72	71	70							
ICELAND																			
Reykjavik.....	64 08N/21 56E	59	8	14	17	59	58	56	16	54	53	53							
INDIA																			
Ahmenabad.....	23 02N/72 35E	163	49	53	56	109	107	105	28	80	79	78							
Bangalore.....	12 57N/77 37E	3021	53	56	58	96	94	93	26	75	74	74							
Bombay.....	18 54N/72 49E	37	62	65	67	96	94	92	13	82	81	81							
Calcutta.....	22 32N/88 20E	21	49	52	54	98	97	96	22	83	82	82							
Madras.....	13 04N/80 15E	51	61	64	66	104	102	101	19	84	83	83							
Nagpur.....	21 09N/79 07E	1017	45	51	54	110	108	107	30	79	79	78							
New Delhi.....	28 35N/77 12E	703	35	39	41	110	107	105	26	83	82	82							
INDONESIA																			
Djakarta.....	6 11S/106 50E	26	69	71	72	90	89	88	14	80	79	78							
Kupang.....	10 10S/123 34E	148	63	66	68	94	93	92	20	81	80	80							
Makassar.....	5 08S/119 28E	61	64	66	68	90	89	88	17	80	80	79							
Medan.....	3 35N/98 41E	77	66	69	71	92	91	90	17	81	80	79							
Palembang.....	3 00S/104 46E	20	67	70	71	92	91	90	17	80	79	79							
Surabaya.....	7 13S/112 43E	10	64	66	68	91	90	89	18	80	79	79							

Climatic Conditions for Other Foreign Countries (Continued)

Col. 1 Country and Station	Col. 2 Latitude and Longitude	Col. 3 Elevation, Ft	Winter			Summer								
			Col. 4			Col. 5 Design Dry-Bulb			Col. 6 Out-door Daily Range F deg	Col. 7 Design Wet-Bulb				
			Mean of Annual Ex-tremes	99%	97½%	1%	2½%	5%		1%	2½%	5%		
IRAN														
Abadan.....	30 21N/48 16E	7	32	39	41	116	113	110	32	82	81	81		
Meshed.....	36 17N/59 36E	3104	3	10	14	99	96	93	29	68	67	66		
Tehran.....	35 41N/51 25E	4002	15	20	24	102	100	98	27	75	74	73		
IRAQ														
Baghdad.....	33 20N/44 24E	111	27	32	35	113	111	108	34	73	72	72		
Mosul.....	36 19N/43 09E	730	23	29	32	114	112	110	40	73	72	72		
IRELAND														
Dublin.....	53 22N/6 21W	155	19	24	27	74	72	70	16	65	64	62		
Shannon.....	52 41N/8 55W	8	19	25	28	76	73	71	14	65	64	63		
ISRAEL														
Jerusalem.....	31 47N/35 13E	2485	31	36	38	95	94	92	24	70	69	69		
Tel Aviv.....	32 06N/34 47E	36	33	39	41	96	93	91	16	74	73	72		
ITALY														
Milan.....	45 27N/09 17E	341	12	18	22	89	87	84	20	76	75	74		
Naples.....	40 53N/14 18E	220	28	34	36	91	88	86	19	74	73	72		
Rome.....	41 48N/12 36E	377	25	30	33	94	92	89	24	74	73	72		
IVORY COAST														
Abidjan.....	5 19N/4 01W	65	64	67	69	91	90	88	15	83	82	81		
JAPAN														
Fukuoka.....	33 35N/130 27E	22	26	29	31	92	90	89	20	82	80	79		
Sapporo.....	43 04N/141 21E	56	- 7	1	5	86	83	80	20	76	74	72		
Tokyo.....	35 41N/139 46E	19	21	26	28	91	89	87	14	81	80	79		
JORDAN														
Amman.....	31 57N/35 57E	2548	29	33	36	97	94	92	25	70	69	68		
KENYA														
Nairobi.....	1 16S/36 48E	5971	45	48	50	81	80	78	24	66	65	65		
KOREA														
Pyeongyang.....	39 02N/125 41E	186	-10	- 2	3	89	87	85	21	77	76	76		
Seoul.....	37 34N/126 58E	285	- 1	7	9	91	89	87	16	81	79	78		
LEBANON														
Beirut.....	33 54N/35 28E	111	40	42	45	93	91	90	15	78	77	76		
LIBERIA														
Monrovia.....	6 18N/10 48W	75	64	68	69	90	89	88	19	82	82	81		
LIBYA														
Bengasi.....	32 06N/20 04E	82	41	46	48	97	94	91	13	77	76	75		
MADAGASCAR														
Tananarive.....	18 55S/47 33E	4531	39	43	46	86	84	83	23	73	72	71		
MALAYSIA														
Kuala Lumpur.....	3 07N/101 42E	127	67	70	71	94	93	92	20	82	82	81		
Penang.....	5 25N/100 19E	17	69	72	73	93	93	92	18	82	81	80		
Singapore.....	1 18N/103 50E	33	69	71	72	92	91	90	14	82	81	80		
MARTINIQUE														
Fort de France.....	14 37N/61 05W	13	62	64	66	90	89	88	14	81	81	80		
MEXICO														
Guadalajara.....	20 41N/103 20W	5105	35	39	42	93	91	89	29	68	67	66		
Mérida.....	20 58N/89 38W	72	56	59	61	97	95	94	21	80	79	77		
Mexico City.....	19 24N/99 12W	7575	33	37	39	83	81	79	25	61	60	59		
Monterrey.....	25 40N/100 15W	1732	31	38	41	98	95	93	20	79	78	77		
Vera Cruz.....	19 12N/96 08W	184	55	60	62	91	89	88	12	83	83	82		
MOROCCO														
Casablanca.....	33 35N/7 39W	164	36	40	42	94	90	86	50	73	72	70		
NEPAL														
Katmandu.....	27 42N/85 12E	4388	30	33	35	89	87	86	25	78	77	76		
NETHERLANDS														
Amsterdam.....	52 23N/4 55E	5	17	20	23	79	76	73	10	65	64	63		
NEW GUINEA														
Manokwari.....	0 52S/134 05E	62	70	71	72	89	88	87	12	82	81	81		
Point Moresby.....	9 29S/147 09E	126	62	67	69	92	91	90	14	80	80	79		
NEW ZEALAND														
Auckland.....	36 51S/174 46E	140	37	40	42	78	77	76	14	67	66	65		
Christ Church.....	43 32S/172 37E	32	25	28	31	82	79	76	17	68	67	66		
Wellington.....	41 17S/174 46E	394	32	35	37	76	74	72	14	66	65	64		
NICARAGUA														
Managua.....	12 10N/86 15W	135	62	65	67	94	93	92	21	81	80	79		
NIGERIA														
Lagos.....	6 27N/3 24E	10	67	70	71	92	91	90	12	82	82	81		
NORWAY														
Bergen.....	60 24N/5 19E	141	14	17	20	75	74	73	21	67	66	65		
Oslo.....	59 56N/10 44E	308	- 2	0	4	79	77	74	17	67	66	64		



Climatic Conditions for Other Foreign Countries (Continued)

Col. 1 Country and Station	Col. 2 Latitude and Longitude	Col. 3 Elevation, Ft	Winter			Summer								
			Col. 4			Col. 5 Design Dry-Bulb			Col. 6 Out- door Daily Range F deg	Col. 7 Design Wet-Bulb				
			Mean of Annual Ex- tremes	99%	97½%	1%	2½%	5%		1%	2½%	5%		
PAKISTAN														
Chittagong.....	22 21N/91 50E	87	48	52	54	93	91	89	20	82	81	81		
Karachi.....	24 48N/66 59E	13	45	49	51	100	98	95	14	82	82	81		
Lahore.....	31 35N/74 20E	702	32	35	37	109	107	105	27	83	82	81		
Peshwar.....	34 01N/71 35E	1164	31	35	37	109	106	103	29	81	80	79		
PANAMA AND CANAL ZONE														
Panama City.....	8 58N/79 33W	21	69	72	73	93	92	91	18	81	81	80		
PARAGUAY														
Asunción.....	25 17S/57 30W	456	35	43	46	100	98	96	24	81	81	80		
PERU														
Lima.....	12 05S/77 03W	394	51	53	55	86	85	84	17	76	75	74		
PHILIPPINES														
Manila.....	14 35N/120 59E	47	69	73	74	94	92	91	20	82	81	81		
POLAND														
Kraków.....	50 04N/19 57E	723	- 2	2	6	84	81	78	19	68	67	66		
Warsaw.....	52 13N/21 02E	394	- 3	3	8	84	81	78	19	71	70	68		
PORTUGAL														
Lisbon.....	38 43N/9 08W	313	32	37	39	89	86	83	16	69	68	67		
PUERTO RICO														
San Juan.....	18 29N/66 07W	82	65	67	68	89	88	87	11	81	80	79		
RUMANIA														
Bucharest.....	44 25N/26 06E	269	- 2	3	8	93	91	89	26	72	71	70		
SAUDI ARABIA														
Dhahran.....	26 17N/50 09E	80	39	45	48	111	110	108	32	86	85	84		
Jedda.....	21 28N/39 10E	20	52	57	60	106	103	100	22	85	84	83		
Riyadh.....	24 39N/46 42E	1938	29	37	40	110	108	106	32	78	77	76		
SENEGAL														
Dakar.....	14 42N/17 29W	131	58	61	62	95	93	91	13	81	80	80		
SOMALIA														
Mogadiscio.....	2 02N/49 19E	39	67	69	70	91	90	89	12	82	82	81		
SOUTH AFRICA														
Capetown.....	33 56S/18 29E	55	36	40	42	93	90	86	20	72	71	70		
Johannesburg.....	26 11S/78 03E	5463	26	31	34	85	83	81	24	70	69	69		
Pretoria.....	25 45S/28 14E	4491	27	32	35	87	87	85	23	70	69	68		
SOVIET UNION														
Alma Ata.....	43 14N/76 53E	2543	-18	-10	- 6	88	86	83	21	69	68	67		
Archangel.....	64 33N/40 32E	22	-29	-23	-18	75	71	68	13	60	58	57		
Kaliningrad.....	54 43N/20 30E	23	3	+ 1	6	83	80	77	17	67	66	65		
Krasnoyarsk.....	56 01N/92 57E	498	-41	-32	-27	84	80	76	12	64	62	60		
Kiev.....	50 27N/30 30E	600	-12	- 5	+ 1	87	84	81	22	69	68	67		
Kharkov.....	50 00N/36 14E	472	-19	-10	- 3	87	84	82	23	69	68	67		
Kuibyshev.....	53 11N/50 06E	190	-23	-19	-13	89	85	81	20	69	67	66		
Leningrad.....	59 56N/30 16E	16	-14	- 9	- 5	78	75	72	15	65	64	63		
Minsk.....	53 54N/27 33E	738	-19	-11	- 4	80	77	74	16	67	66	65		
Moscow.....	55 46N/37 40E	505	-19	-11	- 6	84	81	78	21	69	67	65		
Odessa.....	46 29N/30 44E	214	- 1	4	8	87	84	82	14	70	69	68		
Petropavlovsk.....	52 53N/158 42E	286	- 9	- 3	0	70	68	65	13	58	57	56		
Rostov on Don.....	47 13N/39 43E	159	- 9	- 2	4	90	87	84	20	70	69	68		
Sverdlovsk.....	56 49N/60 38E	894	-34	-25	-20	80	76	72	16	63	62	60		
Tashkent.....	41 20N/69 18E	1569	- 4	3	8	95	93	90	29	71	70	69		
Tbilisi.....	41 43N/44 48E	1325	12	18	22	87	85	83	18	68	67	66		
Vladivostok.....	43 07N/131 55E	94	-15	-10	- 7	80	77	74	11	70	69	68		
Volgograd.....	48 42N/44 31E	136	-21	-13	- 7	93	89	86	19	71	70	69		
SPAIN														
Barcelona.....	41 24N/2 09E	312	31	33	36	88	86	84	13	75	74	73		
Madrid.....	40 25N/3 41W	2188	22	25	28	93	91	89	25	71	69	67		
Valencia.....	39 28N/0 23W	79	31	33	37	92	90	88	14	75	74	73		
SUDAN														
Khartoum.....	15 37N/32 33E	1279	47	53	56	109	107	104	30	77	76	75		
SURINAM														
Paramaribo.....	5 49N/55 09W	12	66	68	70	93	92	90	18	82	82	81		
SWEDEN														
Stockholm.....	59 21N/18 04E	146	3	5	8	78	74	72	15	64	62	60		
SWITZERLAND														
Zurich.....	47 23N/8 33E	1617	4	9	14	84	81	78	21	68	67	66		
SYRIA														
Damascus.....	33 30N/36 20E	2362	25	29	32	102	100	98	35	72	71	70		
TAIWAN														
Tainan.....	22 57N/120 12E	70	40	46	49	92	91	90	14	84	83	82		
Taipei.....	25 02N/121 31E	30	41	44	47	94	92	90	16	83	82	81		

Table C2  
Earth Temperature Tables  
for  
Underground Heat Distribution System Design

The following Tables TG-1 through TG-11 were developed by applying monthly average temperatures prepared by the U. S. Weather Bureau for many localities in the United States to a technique described in the 1965 ASHRAE technical paper entitled "Earth Temperature and Thermal Diffusivity at Selected Stations in the United States" by T. Kusuda and P. R. Achenbach. These temperature data are, however, for the undisturbed earth. The earth temperature immediately under the building may be estimated by taking an arithmetic average of the building temperature and the design earth temperature found in the appropriate table. For example, the floor on grade in the Washington, D. C. area may be treated as a slab of 12" thickness with ground temperature of 70.5 °F if the room temperature is 75 °F and the summer design TG is determined from the data of Upper Marlboro, Maryland for ALPHA = 0.025 which is 66 °F.

Table TG-1  
 DRY SOIL

AVERAGE EARTH TEMPERATURE IN DEG. F,		TG				
THERMAL DIFFUSIVITY IN FT**2/HR		ALPHA= .010				
STATION	STATES	WINTER	SPRING	SUMMER	FALL	YEAR
AUBURN,	ALABAMA	60.	61.	71.	70.	65.
DECATUR,	ALABAMA	52.	54.	65.	65.	59.
PALMER ARES,	ALASKA	31.	31.	42.	41.	36.
TEMPE,	ARIZONA	62.	64.	73.	74.	68.
TUCSON,	ARIZONA	68.	69.	77.	79.	73.
BRAWLEY,	CALIFORNIA	70.	73.	83.	84.	77.
DAVIS,	CALIFORNIA	61.	61.	72.	72.	67.
FT. COLLINS,	COLO.	44.	45.	58.	56.	51.
STORRS,	CONN.	46.	45.	58.	58.	52.
GAINESVILLE,	FLA.	65.	70.	77.	77.	73.
ATHENS,	GEORGIA	59.	61.	72.	72.	66.
MOSCOW,	IDAHO	43.	42.	52.	52.	47.
LEMONT,	ILLINOIS	46.	45.	59.	59.	52.
URBANA,	ILLINOIS	46.	47.	61.	60.	53.
WEST LAFAYETTE,	IND	47.	47.	62.	61.	54.
AMES,	IOWA	44.	45.	62.	60.	52.
BURLINGTON,	IOWA	47.	49.	66.	65.	56.
CASTANA,	IOWA	42.	42.	61.	59.	51.
COUNCIL BLUFFS,	IOWA	47.	47.	62.	62.	55.
SARATOGA,	IOWA	41.	40.	59.	57.	49.
SPENCER,	IOWA	42.	42.	58.	57.	50.
GARDEN CITY,	KANSAS	48.	51.	66.	66.	58.
MANHATTAN,	KANSAS	48.	50.	64.	64.	56.
MOUND VALLEY,	KANSAS	52.	54.	68.	68.	60.
LEXINGTON,	KENTUCKY	51.	52.	65.	64.	58.
UPPER MARLBORO,	MD.	48.	49.	63.	63.	56.
EAST LANSING,	MICH.	45.	43.	57.	57.	50.
FAIRMONT,	MINNESOTA	42.	43.	58.	57.	50.
FARIBAULT,	MINNESOTA	40.	40.	55.	53.	47.
ST. PAUL,	MINNESOTA	42.	40.	57.	56.	49.
WASECA,	MINNESOTA	41.	46.	59.	54.	50.
STATE UNIV.,	MISS.	60.	62.	73.	73.	67.
FAUCETT,	MISSOURI	47.	47.	61.	61.	54.
KANSAS CITY,	MO.	48.	49.	62.	61.	55.
SIKESTON,	MISSOURI	52.	54.	67.	67.	60.
SPICKARD,	MISSOURI	50.	49.	60.	62.	55.
BOZEMAN,	MONTANA	39.	37.	50.	48.	43.
HUNTLEY,	MONTANA	44.	44.	58.	57.	50.
LINCOLN,	NEBRASKA	45.	45.	60.	60.	53.
NEW BRUNSWICK,	N.J.	48.	48.	60.	60.	54.
ITHACA,	NEW YORK	44.	43.	54.	54.	49.
COLUMBUS,	OHIO	47.	47.	59.	60.	53.
COSHOCTON,	OHIO	46.	46.	58.	58.	52.
WOOSTER,	OHIO	46.	46.	58.	58.	52.
BARNSDALL,	OKLAHOMA	56.	57.	69.	69.	63.
LAKE HEFNER,	OKLA.	56.	57.	70.	71.	64.
PAFFHUSKA,	OKLAHOMA	54.	55.	68.	68.	61.
OTTAWA,	ONTARIO	42.	39.	54.	52.	47.
CORVALLIS,	OREGON	50.	51.	61.	60.	55.
HOOD RIVER,	OREGON	46.	48.	57.	57.	52.



AVERAGE EARTH TEMPERATURE IN DEG. F, TG

THERMAL DIFFUSIVITY IN FT\*\*2/HR

ALPHA= .010

STATION	STATES	WINTER	SPRING	SUMMER	FALL	YEAR
MEDFORD,	OREGON	51.	52.	61.	61.	56.
PENDLETON,	OREGON	46.	49.	61.	60.	54.
STATE COLLEGE,	PA.	46.	45.	59.	58.	52.
KINGSTON,	R. I.	45.	43.	55.	56.	50.
CALHOUN,	S. CAROLINA	56.	58.	70.	69.	63.
MADISON,	S. DAKOTA	40.	40.	54.	54.	47.
JACKSON,	TENNESSEE	53.	55.	66.	64.	59.
TEMPLE,	TEXAS	64.	65.	77.	77.	71.
SALT LAKE CITY,	UTAH	44.	45.	56.	55.	50.
BURLINGTON,	VERMONT	42.	40.	54.	53.	48.
PULLMAN,	WASHINGTON	43.	46.	55.	52.	50.
SEATTLE,	WASHINGTON	48.	50.	56.	56.	53.
AFTON,	WYOMING	43.	43.	53.	53.	48.

Table TG-2  
AVERAGE SOIL

AVERAGE EARTH TEMPERATURE IN DEG. F,		TG				
THERMAL DIFFUSIVITY IN FT**2/HR		ALPHA= .025				
STATION	STATES	WINTER	SPRING	SUMMER	FALL	YEAR
AUBURN,	ALABAMA	57.	61.	74.	70.	65.
DECATUR,	ALABAMA	49.	53.	69.	66.	59.
PALMER ARES,	ALASKA	29.	30.	45.	41.	36.
TEMPE,	ARIZONA	58.	63.	77.	74.	68.
TUCSON,	ARIZONA	65.	69.	80.	80.	73.
BRAWLEY,	CALIFORNIA	66.	73.	87.	85.	77.
DAVIS,	CALIFORNIA	57.	60.	76.	73.	67.
FT. COLLINS,	COLO.	40.	44.	62.	57.	51.
STORRS,	CONN.	43.	44.	62.	59.	52.
GAINESVILLE,	FLA.	61.	71.	79.	78.	73.
ATHENS,	GEORGIA	55.	60.	75.	73.	66.
MOSCOW,	IDAHO	40.	42.	55.	53.	47.
LEMONT,	ILLINOIS	42.	44.	64.	60.	52.
URBANA,	ILLINOIS	42.	47.	65.	61.	53.
WEST LAFAYETTE,	IND	43.	47.	66.	62.	54.
AMES,	IOWA	39.	44.	67.	61.	52.
BURLINGTON,	IOWA	42.	48.	71.	66.	56.
CASTANA,	IOWA	36.	41.	66.	61.	51.
COUNCIL BLUFFS,	IOWA	42.	47.	67.	63.	55.
SARATOGA,	IOWA	37.	39.	64.	58.	49.
SPENCER,	IOWA	37.	41.	62.	58.	50.
GARDEN CITY,	KANSAS	42.	51.	71.	67.	58.
MANHATTAN,	KANSAS	44.	49.	68.	65.	56.
MOUND VALLEY,	KANSAS	47.	54.	72.	69.	60.
LEXINGTON,	KENTUCKY	47.	51.	69.	65.	58.
UPPER MARLBORO,	MD.	44.	49.	66.	64.	56.
EAST LANSING,	MICH.	41.	41.	61.	58.	50.
FAIRMONT,	MINNESOTA	38.	43.	63.	57.	50.
FARIBAULT,	MINNESOTA	36.	38.	59.	54.	47.
ST. PAUL,	MINNESOTA	38.	38.	62.	57.	49.
WASECA,	MINNESOTA	36.	47.	64.	54.	50.
STATE UNIV.,	MISS.	56.	62.	76.	74.	67.
FAUCETT,	MISSOURI	43.	45.	65.	61.	54.
KANSAS CITY,	MO.	44.	48.	65.	62.	55.
SIKESTON,	MISSOURI	48.	54.	72.	68.	60.
SPICKARD,	MISSOURI	47.	48.	63.	64.	55.
BOZEMAN,	MONTANA	36.	36.	53.	49.	43.
HUNTLEY,	MONTANA	40.	43.	63.	57.	50.
LINCOLN,	NEBRASKA	40.	44.	65.	61.	53.
NEW BRUNSWICK,	N.J.	44.	47.	63.	61.	54.
ITHACA,	NEW YORK	41.	41.	58.	54.	49.
COLUMBUS,	OHIO	43.	46.	63.	61.	53.
CUSHOCTON,	OHIO	42.	45.	61.	59.	52.
WOOSTER,	OHIO	42.	45.	62.	59.	52.
BARNSDALL,	OKLAHOMA	53.	56.	73.	70.	63.
LAKE HEFNER,	OKLA.	52.	56.	74.	72.	64.
PAWBUKA,	OKLAHOMA	50.	54.	72.	68.	61.
OTTAWA,	ONTARIO	39.	37.	58.	52.	47.
CORVALLIS,	OREGON	47.	50.	64.	60.	55.
HOOD RIVER,	OREGON	43.	48.	59.	57.	52.

AVERAGE EARTH TEMPERATURE IN DEG. F, TG

THERMAL DIFFUSIVITY IN FT\*\*2/HR ALPHA= .025

STATION	STATES	WINTER	SPRING	SUMMER	FALL	YEAR
MEUFORD,	OREGON	48.	52.	64.	61.	56.
PENDLETON,	OREGON	41.	49.	65.	61.	54.
STATE COLLEGE,	PA.	42.	44.	63.	59.	52.
KINGSTON,	R. I.	41.	41.	58.	57.	50.
CALHOUN,	S. CAROLINA	52.	57.	73.	70.	63.
MADISON,	S. DAKOTA	36.	38.	59.	55.	47.
JACKSON,	TENNESSEE	50.	55.	69.	64.	59.
TEMPLE,	TEXAS	61.	65.	81.	77.	71.
SALT LAKE CITY,	UTAH	40.	45.	60.	56.	50.
BURLINGTON,	VERMONT	39.	38.	59.	54.	48.
PULLMAN,	WASHINGTON	40.	45.	58.	52.	50.
SEATTLE,	WASHINGTON	46.	50.	59.	56.	53.
AFTON,	WYOMING	41.	42.	56.	53.	48.

Table TG-3  
WET SOIL

AVERAGE EARTH TEMPERATURE IN DEG. F,		TG				
THERMAL DIFFUSIVITY IN FT**2/HR		ALPHA= .050				
STATION	STATES	WINTER	SPRING	SUMMER	FALL	YEAR
AUBURN,	ALABAMA	54.	61.	76.	70.	65.
DECATUR,	ALABAMA	46.	53.	71.	65.	59.
PALMER ARES,	ALASKA	27.	30.	48.	41.	36.
TEMPE,	ARIZONA	56.	64.	79.	74.	68.
TUCSON,	ARIZONA	62.	69.	82.	81.	73.
BRAWLEY,	CALIFORNIA	63.	73.	90.	84.	77.
DAVIS,	CALIFORNIA	55.	60.	78.	73.	67.
FT. COLLINS,	COLO.	37.	45.	65.	56.	51.
STORRS,	CONN.	40.	44.	65.	59.	52.
GAINESVILLE,	FLA.	58.	72.	81.	79.	73.
ATHENS,	GEORGIA	52.	61.	78.	73.	66.
MOSCOW,	IDAHO	38.	42.	57.	53.	47.
LEMONT,	ILLINOIS	39.	44.	67.	60.	52.
URBANA,	ILLINOIS	39.	47.	68.	60.	53.
WEST LAFAYETTE,	IND	40.	47.	69.	62.	54.
AMES,	IOWA	35.	44.	70.	61.	52.
BURLINGTON,	IOWA	38.	48.	74.	66.	56.
CASTANA,	IOWA	32.	42.	70.	61.	51.
COUNCIL BLUFFS,	IOWA	39.	47.	70.	63.	55.
SARATOGA,	IOWA	33.	39.	68.	58.	49.
SPENCER,	IOWA	33.	42.	66.	58.	50.
GARDEN CITY,	KANSAS	38.	52.	74.	67.	58.
MANHATTAN,	KANSAS	40.	49.	72.	65.	56.
MOUND VALLEY,	KANSAS	44.	55.	75.	69.	60.
LEXINGTON,	KENTUCKY	44.	51.	72.	65.	58.
UPPER MARLBORO,	MD.	41.	49.	69.	64.	56.
EAST LANSING,	MICH.	39.	41.	64.	57.	50.
FAIRMONT,	MINNESOTA	35.	43.	67.	57.	50.
FARIBAULT,	MINNESOTA	34.	38.	62.	54.	47.
ST. PAUL,	MINNESOTA	35.	38.	65.	57.	49.
WASECA,	MINNESOTA	31.	49.	67.	53.	50.
STATE UNIV.,	MISS.	53.	62.	78.	74.	67.
FAUCETT,	MISSOURI	41.	45.	68.	61.	54.
KANSAS CITY,	MO.	41.	48.	68.	61.	55.
SIKESTON,	MISSOURI	45.	54.	75.	68.	60.
SPICKARD,	MISSOURI	44.	48.	65.	64.	55.
BOZEMAN,	MONTANA	34.	35.	57.	48.	43.
HUNTLEY,	MONTANA	37.	43.	66.	57.	50.
LINCOLN,	NEBRASKA	36.	44.	68.	62.	53.
NEW BRUNSWICK,	N.J.	41.	47.	66.	62.	54.
ITHACA,	NEW YORK	39.	41.	61.	54.	49.
COLUMBUS,	OHIO	40.	47.	65.	61.	53.
CUSHOCTON,	OHIO	40.	45.	64.	60.	52.
WOOSTER,	OHIO	40.	45.	65.	59.	52.
BARNSDALL,	OKLAHOMA	50.	56.	75.	70.	63.
LAKE HEFNER,	OKLA.	49.	57.	77.	73.	64.
PAWBUKA,	OKLAHOMA	48.	54.	75.	68.	61.
OTTAWA,	ONTARIO	37.	37.	61.	51.	47.
CORVALLIS,	OREGON	45.	51.	67.	60.	55.
HOOVER RIVER,	OREGON	41.	49.	61.	57.	52.

AVERAGE EARTH TEMPERATURE IN DEG. F, TG

THERMAL DIFFUSIVITY IN FT\*\*2/HR

ALPHA= .050

STATION	STATES	WINTER	SPRING	SUMMER	FALL	YEAR
MEUFORD,	OREGON	46.	52.	66.	61.	56.
PENNINGTON,	OREGON	38.	50.	68.	60.	54.
STATE COLLEGE,	PA.	40.	44.	66.	59.	52.
KINGSTON,	R. I.	39.	41.	61.	57.	50.
CALHOUN,	S. CAROLINA	49.	58.	76.	69.	63.
MADISON,	S. DAKOTA	33.	38.	62.	55.	47.
JACKSON,	TENNESSEE	48.	55.	72.	64.	59.
TEMPLE,	TEXAS	58.	65.	84.	77.	71.
SALT LAKE CITY,	UTAH	37.	45.	62.	55.	50.
BURLINGTON,	VERMONT	37.	38.	62.	54.	48.
PULLMAN,	WASHINGTON	37.	45.	60.	50.	50.
SEATTLE,	WASHINGTON	44.	50.	60.	56.	53.
AFTON,	WYOMING	39.	42.	59.	53.	48.

Table C3

Thermophysical Properties of Wall/Roof/Floor

Reprinted by permission from 1972 Handbook of Fundamentals (American Society of Heating, Refrigerating and Air-Conditioning Engineers, 345 East 47th Street, New York, New York), p. 431.



**Thermal Properties and Code Numbers of Layers Used in Calculations of  
Coefficients for Wall and Roof Transfer Functions**

Description	Code Number	Thickness and Thermal Properties <sup>a</sup>				
		L	K	D	SH	R
Outside surface resistance	A0					0.333
1" stucco (asbestos cement or wood siding plaster, etc.)	A1	0.0833	0.4	116	0.20	
4" face brick (dense concrete)	A2	0.333	0.77	125	0.22	
Steel siding (aluminum or other light-weight cladding)	A3	0.005	26.0	480	0.10	
Outside surface resistance, 1/4" slag, membrane and 1/2" felt	A4	0.0417 0.0313	0.83 0.11	55 70	0.40 0.40	0.333
Outside surface resistance	A5					0.333
Finish	A6	0.0417	0.24	78	0.26	
Air space resistance	B1					0.91
1" insulation	B2	0.083	0.025	2.0	0.2	
2" insulation	B3	0.167	0.025	2.0	0.2	
3" insulation	B4	0.25	0.025	2.0	0.2	
1" insulation	B5	0.0833	0.025	5.7	0.2	
2" insulation	B6	0.167	0.025	5.7	0.2	
1" wood	B7	0.0833	0.07	37.0	0.6	
2.5" wood	B8	0.2083	0.07	37.0	0.6	
4" wood	B9	0.333	0.07	37.0	0.6	
2" wood	B10	0.167	0.07	37.0	0.6	
3" wood	B11	0.25	0.07	37.0	0.6	
3" insulation	B12	0.25	0.025	5.7	0.2	
4" clay tile	C1	0.333	0.33	70.0	0.2	
4" l.w. concrete block	C2	0.333	0.22	35.0	0.2	
4" h.w. concrete block	C3	0.333	0.47	61.0	0.2	
4" common brick	C4	0.333	0.42	120	0.2	
4" h.w. concrete	C5	0.333	1.0	140	0.2	
8" clay tile	C6	0.667	0.33	70	0.2	
8" l.w. concrete block	C7	0.667	0.33	35.0	0.2	
8" h.w. concrete block	C8	0.667	0.6	61.0	0.2	
8" common brick	C9	0.667	0.42	120	0.2	
8" h.w. concrete	C10	0.667	1.0	140	0.2	
12" h.w. concrete	C11	1.0	1.0	140	0.2	
2" h.w. concrete	C12	0.167	1.0	140	0.2	
6" h.w. concrete	C13	0.5	1.0	140	0.2	
4" l.w. concrete	C14	0.333	0.1	40	0.2	
6" l.w. concrete	C15	0.5	0.1	40	0.2	
8" l.w. concrete	C16	0.667	0.1	40	0.2	
Inside surface resistance	E0					0.685
1/2" plaster; 1/2" gypsum or other similar finish- ing layer	E1	0.0625	0.42	100	0.2	
1/4" slag or stone	E2	0.0417	0.83	55	0.40	
1/2" felt & membrane	E3	0.0313	0.11	70	0.40	
Ceiling air space	E4					1.0
Acoustic Tile	E5	0.0625	0.035	30	0.20	

<sup>a</sup> Units: L = feet. K = Btu per (hr) (sq ft) (F deg). D = lb per cu ft. SH = Btu per (lb) (F deg). R = (hr) (sq ft) (F deg) per Btu.

Table C4

Typical Watt/ft.<sup>2</sup> of floor area data

	<u>Lighting</u>	<u>Equipment</u>
Apartment	1.7	1.2
Office	5.0	1.0
Department Stores	4.0	0.0
School	5.0	0.0

Table C5

Shading Coefficients

Reprinted by permission from the 1972 Handbook of Fundamentals (American Society of Heating, Refrigerating and Air-Conditioning Engineers, 345 East 47th Street, New York, New York), pp. 402-408.

**Shading Coefficients for Single Glass and  
Insulating Glass<sup>a</sup>**

**A. Single Glass**

Type of Glass	Nominal Thickness <sup>b</sup>	Solar Trans. <sup>b</sup>	Shading Coefficient	
			$h_0 = 4.0$	$h_0 = 3.0$
Regular Sheet Regular Plate/ Float	$\frac{3}{8}, \frac{1}{2}$	0.87	1.00	1.00
	$\frac{1}{4}$	0.80	0.95	0.97
	$\frac{3}{16}$	0.75	0.91	0.93
	$\frac{1}{8}$	0.71	0.88	0.91
Grey Sheet	$\frac{1}{8}$	0.59	0.78	0.80
	$\frac{1}{16}$	0.74	0.90	0.92
	$\frac{1}{32}$	0.45	0.66	0.70
	$\frac{7}{32}$	0.71	0.88	0.90
	$\frac{1}{4}$	0.67	0.86	0.88
Heat-Absorbing Plate/Float <sup>d</sup>	$\frac{1}{8}$	0.52	0.72	0.75
	$\frac{1}{16}$	0.47	0.70	0.74
	$\frac{1}{32}$	0.33	0.56	0.61
	$\frac{1}{4}$	0.24	0.50	0.57

**B. Insulating Glass<sup>a</sup>**

Type of Glass	Nominal Thickness <sup>c</sup>	Solar Trans. <sup>b</sup>		Shading Coefficient	
		Outer Pane	Inner Pane	$h_0 = 4.0$	$h_0 = 3.0$
Regular Sheet Out, Regular Sheet In	$\frac{3}{8}, \frac{1}{2}$	0.87	0.87	0.90	0.90
Regular Plate/Float Out, Regular Plate/Float In	$\frac{1}{4}$	0.80	0.80	0.83	0.83
Heat-Abs Plate/Float Out, Regular Plate/Float In	$\frac{1}{4}$	0.46	0.80	0.56	0.58

<sup>a</sup> Refers to factory-fabricated units with  $\frac{1}{8}$ ,  $\frac{1}{4}$ , or  $\frac{1}{2}$  in. air space or to prime windows plus storm windows.

<sup>b</sup> Refer to manufacturer's literature for values.

<sup>c</sup> Thickness of each pane of glass, not thickness of assembled unit.

<sup>d</sup> Refers to grey, bronze, and green tinted heat-absorbing plate/float glass.

Shading Coefficients for Single Glass with Indoor Shading by Venetian Blinds and Roller Shades

Type of Glass	Nominal Thickness <sup>a</sup>	Solar Trans. <sup>b</sup>	Type of Shading				
			Venetian Blinds		Roller Shade		
			Medium	Light	Opaque		Translucent
				Dark	White	Light	
Regular Sheet Regular Plate/Float Regular Pattern Heat-Absorbing Pattern Grey Sheet	$\frac{3}{32}$ to $\frac{1}{4}$ $\frac{1}{8}$ to $\frac{1}{2}$ $\frac{1}{8}$ to $\frac{3}{32}$ $\frac{1}{8}$ $\frac{3}{16}, \frac{7}{32}$	0.87-0.80 0.80-0.71 0.87-0.79 — 0.74, 0.71	0.64	0.55	0.59	0.25	0.39
Heat-Absorbing Plate/Float <sup>d</sup> Heat-Absorbing Pattern Grey Sheet	$\frac{3}{16}, \frac{1}{4}$ $\frac{3}{16}, \frac{1}{4}$ $\frac{1}{8}, \frac{7}{32}$	0.46 — 0.59, 0.45	0.57	0.53	0.45	0.30	0.36
Heat-Absorbing Plate/Float or Pattern Heat-Absorbing Plate/Float <sup>d</sup>	— $\frac{3}{8}$	0.44-0.30 0.34	0.54	0.52	0.40	0.28	0.32
Heat-Absorbing Plate or Pattern	—	0.29-0.15 0.24	0.42	0.40	0.36	0.28	0.31
Reflective Coated Glass S.C. <sup>c</sup> = 0.30 0.40 0.50 0.60			0.25 0.33 0.42 0.50	0.23 0.29 0.38 0.44			

<sup>a</sup> Refer to manufacturer's literature for values.  
<sup>b</sup> For vertical blinds with opaque white and beige louvers in the tightly closed position, SC is 0.25 and 0.29 when used with glass of 0.71 to 0.80 transmittance.  
<sup>c</sup> Shading Coefficient for glass with no shading device.  
<sup>d</sup> Refers to grey, bronze, and green tinted heat-absorbing plate/float glass.

Shading Coefficients for Insulating Glass<sup>a</sup> with Indoor Shading by Venetian Blinds and Roller Shades

Type of Glass	Nominal Thickness, each light	Solar Trans. <sup>b</sup>		Type of Shading				
		Outer Pane	Inner Pane	Venetian Blinds <sup>c</sup>		Roller Shade		
				Medium	Light	Opaque		Translucent
						Dark	White	Light
Regular Sheet Out Regular Sheet In Regular Plate/Float Out Regular Plate/Float In	$\frac{3}{32}, \frac{1}{8}$ $\frac{1}{4}$	0.87 0.80	0.87 0.80	0.57	0.51	0.60	0.25	0.37
Heat-Absorbing Plate/Float <sup>d</sup> Out Regular Plate/Float In	$\frac{1}{4}$	0.46	0.80	0.39	0.36	0.40	0.22	0.30
Reflective Coated Glass SC <sup>c</sup> = 0.20 0.30 0.40				0.19 0.27 0.34	0.18 0.26 0.33			

<sup>a</sup> Refers to factory-fabricated units with  $\frac{1}{4}$ ,  $\frac{1}{2}$ , or  $\frac{3}{4}$  in. air space, or to prime windows plus storm windows.  
<sup>b</sup> Refer to manufacturer's literature for exact values.  
<sup>c</sup> For vertical blinds with opaque white or beige louvers, tightly closed, SC is approximately the same as for opaque white roller shades.  
<sup>d</sup> Refers to bronze or green tinted heat-absorbing plate/float glass.  
<sup>e</sup> Shading Coefficient for glass with no shading device.

Properties of Representative Indoor Shading

Indoor Shade	Solar Properties (Normal Incidence)		
	Trans.	Reflect.	Absorp.
Venetian Blinds <sup>a</sup> (Ratio of slat width to slat spacing 1.2, slat angle 45 deg)			
Light Colored Slat	0.05	0.55	0.40
Medium Colored Slat	0.05	0.35	0.60
Vertical Blinds			
White Louvers	0.00	0.77	0.23
Roller Shades			
Light Shades (Translucent)	0.25	0.60	0.15
White Shade (Opaque)	0.00	0.80	0.20
Dark Colored Shade (Opaque)	0.00	0.12	0.88

<sup>a</sup> The values shown in this table and preceding tables are based on horizontal Venetian blinds. However, tests show these values may be used for vertical blinds with good accuracy.

Shading Coefficients for Double Glazing with Between-Glass Shading

Type of Glass	Nominal Thickness, each pane	Solar Trans. <sup>a</sup>		Description of Air Space	Type of Shading		
		Outer Pane	Inner Pane		Venetian Blinds		Louvered Sun Screen
					Light	Medium	
Regular Sheet Out } Regular Sheet In } Regular Plate Out } Regular Plate In }	$3\frac{1}{2}, \frac{1}{8}$ $\frac{1}{4}$	0.87 } 0.80 }	0.87 } 0.80 }	Shade in contact with glass or shade separated from glass by air space. Shade in contact with glass-voids filled with plastic.	0.33 —	0.36 —	0.43 0.49
Heat-Abs. Plate/Float <sup>b</sup> Out } Regular Plate In }	$\frac{1}{4}$	0.46	0.80	Shade in contact with glass or shade separated from glass by air space. Shade in contact with glass-voids filled with plastic.	0.28 —	0.30 —	0.37 0.41

<sup>a</sup> Refer to manufacturer's literature for exact values.

<sup>b</sup> Refers to grey, bronze, and green tinted heat-absorbing plate/float glass.



### Shading Coefficients for Single and Insulating Glass with Draperies

Glazing	Glass Trans.	Glass SC*	Shading Coefficient For Index Letters in Fig. 10**											
			A	B	C	D	E	F	G	H	I	J		
Single Glass														
1/2 in. Regular	0.80	0.95	0.35	0.40	0.45	0.50	0.55	0.60	0.65	0.70	0.75	0.80		
1/2 in. Regular	0.71	0.88	0.35	0.39	0.43	0.48	0.52	0.56	0.61	0.66	0.70	0.74		
1/2 in. Heat Abs.	0.46	0.67	0.33	0.36	0.38	0.41	0.44	0.46	0.49	0.52	0.54	0.57		
1/2 in. Heat Abs.	0.34	0.57	0.32	0.34	0.36	0.38	0.41	0.43	0.45	0.47	0.49	0.51		
1/2 in. Heat Abs.	0.24	0.50	0.30	0.32	0.33	0.34	0.36	0.38	0.39	0.40	0.42	0.43		
Reflective Coated (See Manufacturers' literature for exact values)	—	0.60	0.33	0.36	0.38	0.41	0.43	0.46	0.49	0.51	0.54	0.57		
	—	0.50	0.31	0.33	0.34	0.36	0.38	0.39	0.41	0.42	0.44	0.46		
	—	0.40	0.26	0.27	0.28	0.29	0.30	0.32	0.33	0.34	0.35	0.36		
	—	0.30	0.20	0.21	0.21	0.22	0.23	0.23	0.23	0.24	0.24	0.25		
Insulating Glass (1/2 in. Air Space) Regular Out and Regular In	0.64	0.83	0.35	0.37	0.42	0.45	0.48	0.52	0.56	0.58	0.62	0.66		
Heat Abs. Out and Regular In	0.37	0.56	0.32	0.33	0.35	0.37	0.39	0.41	0.43	0.45	0.47	0.49		
Reflective Coated (see Manufacturers' literature for exact values)	—	0.40	0.28	0.28	0.29	0.31	0.32	0.34	0.36	0.37	0.37	0.38		
	—	0.30	0.24	0.24	0.25	0.25	0.26	0.26	0.27	0.27	0.28	0.29		
	—	0.20	0.15	0.15	0.16	0.16	0.17	0.17	0.18	0.18	0.19	0.19		

\* For glass alone, with no drapery.  
 \*\* Shading coefficient values for the SC lines in Fig. 10 for representative glazings. Substitute for the SC index letters in Fig. 10 the values on the line of the glazing selected.

### Shading Coefficients for Louvered Sun Screens

Profile Angle, deg	Group 1		Group 2	
	Trans- mittance	SC	Trans- mittance	SC
10	0.23	0.35	0.25	0.33
20	0.06	0.17	0.14	0.23
30	0.04	0.15	0.12	0.21
40 and above	0.04	0.15	0.11	0.20

Profile Angle, deg	Group 3		Group 4	
	Trans- mittance	SC	Trans- mittance	SC
10	0.40	0.51	0.48	0.59
20	0.32	0.42	0.39	0.50
30	0.21	0.31	0.28	0.38
40 and above	0.07	0.18	0.20	0.30

Group 1. Black, width over spacing ratio 1.15/1, 23 louvers per inch.  
 Group 2. Light color, high reflectance, otherwise same as Group 1.  
 Group 3. Black or dark color, w/s ratio 0.85/1, 17 louvers per inch.  
 Group 4. Light color or unpainted aluminum, high reflectance, otherwise same as Group 3.  
 U-value = 0.85 Btuh/(sq ft)(F deg) for all groups when used with single glazing.

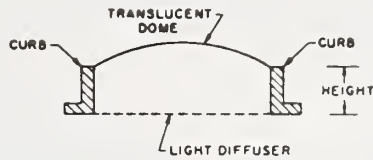

Fig. . . . Terminology for Domed Skylights

Table 23 . . . . Shading Coefficients for Domed Skylights

Dome	Light Diffuser (Translucent)	Curb (See Fig. )		Shading Coefficient	U-Value
		Height, in.	Width to Height Ratio		
Clear $\tau=0.86$	yes $\tau=0.58$	0	$\infty$	0.61	0.46
		9	5	0.58	0.43
		18	2.5	0.50	0.40
Clear $\tau=0.86$	None	0	$\infty$	0.99	0.80
		9	5	0.88	0.75
		18	2.5	0.80	0.70
Translucent $\tau=0.52$	None	0	$\infty$	0.57	0.80
		9	5	0.51	0.75
		18	2.5	0.46	0.70
Translucent $\tau=0.27$	None	0	$\infty$	0.34	0.80
		9	5	0.30	0.75
		18	2.5	0.28	0.70

Shading Coefficients for Hollow Glass Block Wall Panels<sup>a</sup>

Type of Glass Block <sup>b</sup>	Description of Glass Block	Shading Coefficient <sup>c</sup>	
		Panels <sup>d</sup> in the Sun	Panels <sup>e</sup> in the Shade (N, NW, W, SW)
Type I	Glass Colorless or Aqua Smooth Face A, D: Smooth B, C: Smooth or wide ribs, or flutes horizontal or vertical, or shallow configuration. E: None	0.65	0.40
Type IA	Same as Type I except A: Ceramic Enamel on exterior face.	0.27	0.20
Type II	Same as Type I except E: Glass fiber screen.	0.44	0.34
Type III	Glass Colorless or Aqua A, D: Narrow vertical ribs or flutes. B, C: Horizontal light-diffusing prisms, or horizontal light-directing prisms. E: Glass fiber screen.	0.33	0.27
Type IIIA	Same as Type III except E: Glass fiber screen with green ceramic spray coating, or glass fiber screen and gray glass, or glass fiber screen with light-selecting prisms.	0.25	0.18

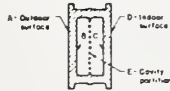

<sup>a</sup> For glass block used in horizontal skylights see Tables 28 and 29, Chapter 26 of the 1963 ASHRAE GUIDE AND DATA BOOK.  
<sup>b</sup> All values are for 7½ × 7½ × 3½ in. block, set in light-colored mortar. For 11½ × 11½ × 3½ in. block increase coefficients by 15 percent, and for 5½ × 5½ × 3½ in. blocks reduce coefficients by 15 percent.  
<sup>c</sup> Shading coefficients are to be applied to Heat Gain Factors for one hour earlier than the time for which the load calculation is made to allow for heat storage in the panel.  
<sup>d</sup> Shading coefficients are for peak load condition, but provide a close approximation for other conditions. For more precise values for other conditions, see Reference 20.  
<sup>e</sup> For NE, E, and SE panels in the shade add 50 percent to the values listed for panels in the shade.

Table C6

Absorptivity of Materials to Solar Radiation

Reprinted by permission from Thermal Radiation Properties Survey (Honeywell Research Center, Minneapolis, Minnesota, 1966), pp. 245-248.

**BUILDING MATERIALS, SOLAR ABSORPTIVITY**

<b>Material</b>	<b>Solar Absorptivity</b>
<b>BRICKS</b>	
Clay, cream, glazed	0.36
Clay, Fleton, dark portion	0.63
Clay, Felton, light portion	0.40
Lime clay, French	0.46
Gault, cream	0.36
Light buff	0.516
Light buff but darker than above	0.60
Mottled purple	0.77
Red	0.699
Red, common and tiles	0.68
Red, darker, glazed	0.766
Red, wire-cut	0.52
Stafford blue	0.89
Stock, light fawn	0.57
White glazed	0.26
White glazed (2 specimens)	0.25-0.27
<b>TILES</b>	
Clay, purple (dark)	0.82
Clay, dark purple, machine-made	0.81
Red	0.67
Red, hand-made	0.60
Red, light, Dutch	0.43
Red, light, machine-ade	0.66
Red, light, machine-made	0.62
Concrete, uncolored	0.65
Concrete, black	0.91
Concrete, dark	0.91
Concrete, brown	0.85
Concrete, brown, very rough	0.88

(Continued on next page)

BUILDING MATERIALS, SOLAR ABSORPTIVITY (Continued)

Material	Solar Absorptivity
<b>ASPHALT</b>	
New, 3 specimens	0.91
New, 3 specimens	0.91
New, another specimen	0.93
Pavement	0.852
Pavement, free from dust	0.928
Pavement, weathered, 3 specimens	0.82
	0.83
	0.89
<b>ROOFING</b>	
Bituminous felt, aluminized	0.40
Bituminous felt	0.88
Bituminous felt	0.89
Bitumin-covered, brown	0.87
Sheet, green	0.86
Sheet, black matte surface	0.97
Sheet, black matte surface	0.97
<b>ASBESTOS CEMENT</b>	
Aged	0.75
Aged 6 months	0.61
Aged 12 months	0.71
Aged 6 years, very dirty	0.83
Red	0.69
Red	0.74
Washed with soap and water	0.40
White	0.61
White (2 samples)	0.49-0.42
<b>LIMESTONE</b>	
Anston	0.60
Bath	0.53
Clipsham	0.46
Indiana	0.571
Ketton	0.42
Portland	0.36
Steetley	0.33
<b>SAND-LIME</b>	
Light-red	0.55
Red	0.68
White, fine sand	0.41
White, coarse sand	0.50
<b>MARBLE</b>	
White	0.44
Ground, unpolished	0.465
Cleavage	0.592
<b>GRANITE</b>	
Reddish	0.55
<b>FELDSPAR</b>	
$K_2O Al_2O_3 6SiO_2$	0.606
<b>MORTAR SCREENED</b>	
	0.73

(Continued on next page)

BUILDING MATERIALS, SOLAR ABSORPTIVITY (Continued)

Material	Solar Absorptivity
<b>SANDSTONE</b>	
Grey, Bristol pennant	0.76
Polmaise, light fawn	0.54
Stancliffe, light grey	0.62
Woolton, red	0.73
<b>WHITEWASH</b>	
On galvanized iron	0.22
On galvanized iron	0.22
On galvanized iron	0.26
On galvanized iron, a very thick layer	0.20
<b>SLATE</b>	
Blue grey	0.87
Blue, grey	0.85
Clay, dark	0.933
Greenish, grey, rough	0.88
Grey, dark	0.90
Grey, dark, fairly rough	0.90
Grey, dark, fairly rough	0.90
Grey, dark, smooth	0.89
Purple	0.86
Silver-grey, Norwegian	0.79

BUILDING MATERIALS, SOLAR ABSORPTIVITY

Building Materials	Solar Absorptivity
Thickly tinned surface	0.05
Wood, smoothly planed	0.78
Basalt	0.72
Red sandstone	0.60
Marble (white)	0.58
Granite	0.45
Dolomite lime	0.41
Clay shale	0.69
Paris plaster	0.78
White plastered wall	0.92
Gravel	0.29
Sand	0.76
Glass	0.93
Sawdust	0.75
Clay	0.39
Red brick wall	0.93



CLOTH, SOLAR REFLECTIVITY

Material	Solar Reflectivity
QM1, cotton sheeting bleached, 4 oz per yd	0.62-0.66
QM2, cotton sateen prepared for dyeing, 9 oz per yd	0.68-0.72
QM4, cotton sateen undyed, 9 oz per yd	0.69-0.72
QM6, cotton sateen, medium gray, 9 oz per yd	0.53
QM7, cotton sateen dark gray, 9 oz per yd	0.24
50 percent wool, 50 percent cotton knit, undyed, 10.5 oz per yd	0.62
Cotton knit, undyed, 3 oz per yd	0.60

PARACHUTE CLOTH, SOLAR ABSORPTIVITY, REFLECTIVITY, AND TRANSMISSIVITY

Material	Absorptivity	Reflectivity	Transmissivity
Dacron, 100 lb	0.05	0.35	0.60
Dacron, 300 lb	0.11	0.54	0.35
Dacron, 600 lb	0.12	0.61	0.27
Dacron, 800 lb	0.19	0.62	0.19
Nylon rip-stop (orange) 1.1 oz per sq yd, MIL-C-7020B Type I	0.13	0.23	0.64
Nylon rip-stop 1.1 oz per sq yd (white) MIL-C-7020	0.08	0.27	0.65
Nylon rip-stop 1.6 oz per sq yd (white) MIL-C-7020B Type III	0.06	0.22	0.72
Nylon cloth 2.25 oz per sq yd, MIL-C-7350B Type I	0.05	0.36	0.59
Nylon cloth 4.30 oz per sq yd, MIL-C-8021 Type I	0.08	0.44	0.48
Nylon cloth 7.0 oz per sq yd, MIL-C-8021 Type II	0.13	0.46	0.41
Nylon cloth 14.0 oz per sq yd, MIL-C-8021 Type III	0.11	0.62	0.27

10. Appendix D

Fortran Listing of NBSLD

Although the attached Fortran listing of the NBSLD routine basically embodies the algorithms of Appendix A, some of the subroutines are considerably simplified if compared with the exact adaptation of Appendix A.

It is cautioned also that the Fortran used herein is the UNIVAC version of Fortran V, which is somewhat different from the ANSI standard Fortran.



```

1 @FCR, IS A1
2 C NBSLD IS A RESEARCH PROGRAM THAT IS CONTINUALLY CHANGED AND UPDATED.
3 C .....NBSLD.....
4 C
5 C
6 C NBSLD IS A RESEARCH PROGRAM OF NBS FOR THE PURPOSE OF
7 C STUDYING HEATING AND COOLING LOAD AND ROOM TEMPERATURE
8 C OF BUILDING UNDER ACTUAL WEATHER CONDITION
9 C A(I) AREA OF SURFACE I, FT2
10 C ABSP(I) SOLAR HEAT ABSORPTION COEFFICIENT FOR SURFACE I.
11 C THIS DATA REQUIRED FOR OPAQUE SURFACES ONLY.
12 C AENDW AREA OF THE ATTIC END WALL, FT2
13 C AG GROUND HEAT TRANSFER AREA, FT2 (MAY=0.)
14 C AIRCHG NO. OF ATTIC AIR CHANGES PER HR, DAYTIME
15 C AIRNT ATTIC NIGHT TIME AIR CHANGE MULTIPLIER
16 C ARCHGS NO. OF AIR CHANGES PER HR IN SUMMER
17 C ARCHGW NO. OF AIR CHANGES PER HR IN WINTER
18 C ATCACG NO. OF ATTIC AIR CHANGES PER HR (DAY OF NIGHT)
19 C AVEHTG AVERAGE HOURLY HEAT GAIN ENTIRE BUILDING, BTU/HR
20 C AZW(I) WALL AZIMUTH ANGLE FOR SURFACE I, DEGREES
21 C SOUTH = 0.
22 C WEST = 90.
23 C NORTH = 180.
24 C EAST = -90.
25 C BLDMAX BUILDING MAXIMUM SENSIBLE HEAT GAIN, BTU/HR
26 C CFML SUMMER INFILTRATION RATE, FT3/MIN.
27 C CFMV VENTILATION RATE, FT3/MIN.
28 C CFMWT WINTER INFILTRATION, FT3/MIN.
29 C CLDAY DAILY TCTAL ENERGY CONSUMPTION FOR A GRUOP
30 C (NCRM OF THEM) OF ROOMS OF THE SAME CONFIG-
31 C URATION, BTU
32 C CLDSUM RUNNING TOTAL ENERGY CONSUMPTION FOR COOLING OF
33 C ALL THE ROOMS IN A BUILDING OVER A SET TIME
34 C PERIOD, BTU
35 C CN CLEARNESS NUMBER
36 C CR(L) RESPONSE FACTOR COMMON RATIO FOR CONSTRUCTION L
37 C DAY DAY OF YEAR
38 C DAYSKP NO. OF DAYS TO BE SKIPPED FROM THE WEATHER TAPE
39 C (FROM ITS LAST STARTING POSITION)
40 C DB(J) OUTDOOR DRYBULB TEMPERATURE AT HOUR J, F
41 C DBA DAILY AVERAGE OUTSIDE DRYBULB TEMPERATURE, F
42 C DBIN DESIGN INDOOR DRYBULB TEMPERATURE, F
43 C DBM DRYBULB MEAN, F
44 C DBMAX DESIGN OUTDOOR MAXIMUM DRYBULB TEMPERATURE, F
45 C DBMWT DESIGN WINTER OUTDOOR DRYBULB TEMPERATURE, F
46 C DBNBS(J) FRACTION OF RANGE TO USE FOR DESIGN PROFILE
47 C AT HOUR J
48 C DP OUTDOOR DEW POINT, F
49 C DPID INDOOR DEW POINT, F
50 C DPIN DESIGN INDOOR DEW POINT, F
51 C DR(L) RESPONSE FACTOR COMMON RATIO FOR CONSTRUCTION L
52 C (SAME AS CR(L))
53 C DST DAYLIGHT SAVING TIME INDICATOR
54 C ELAPS DAYS ELAPSED SINCE JANUARY 1
55 C G(IV,VI) RADIATION CONFIGURATION FACTORS FOR
56 C RADIATION FROM SURFACE VI TO SURFACE IV
57 C H(I) EXTERIOR SURFACE HEAT TRANSFER COEFFICIENT
58 C FOR SURFACE I, BTU/HR,FT2,F

```

59 C HI(I) INTERIOR SURFACE CONVECTION HEAT TRANSFER  
60 C COEFFICIENT, BTU/HR,FT<sup>2</sup>,F  
61 C HIND INDCOR ENTHALPY FOR DESIGN CONDITIONS, BTU/LB  
62 C HLDAY DAILY TOTAL ENERGY CONSUMPTION FOR HEATING FOR A  
63 C GROUP (NORM OF THEM) OF ROOMS OF THE SAME  
64 C CONFIGURATION, BTU  
65 C HLDSUM RUNNING TOTAL ENERGY CONSUMPTION FOR HEATING OF  
66 C ALL THE ROOMS IN A BUILDING, BTU  
67 C HOUT OUTDOOR ENTHALPY FOR DESIGN CONDITIONS, BTU/LB  
68 C HR INNER SURFACE RADIATIVE HEAT TRANSFER COEFFICIENT  
69 C (=4.\*(535.\*\*3)\*SIGMA)  
70 C HT CEILING HEIGHT, FT  
71 C IHT(I) HEAT TRANSFER INDEX  
72 C =-1 FOR GLASS SURFACE  
73 C = 0 OPAQUE  
74 C = 1 OTHERWISE  
75 C IMAX HOUR OF DAY FOR MAXIMUM COOLING LOAD  
76 C INCLUD =0 INCLUDE ROOM IN SUMMARY  
77 C =1 OTHERWISE  
78 C IRF(I) RESPONSE FACTOR INDEX FOR SURFACE I  
79 C IROT DEGREES OF ROTATION  
80 C ISKIP = 1 SKIP RESPONSE FACTOR CALCULATION  
81 C AND BUILDING DATA INPUT  
82 C = 0 OTHERWISE  
83 C ITK AND ITHST INDICES FOR ROOM TEMPERATURE COMPUTATION  
84 C ITK=0, ITHST=1 ROOM TEMP PRESCRIBED, EITHER CONSTANT  
85 C OR WITH NIGHT TIME SET-BACK  
86 C ITK=1, ITHST=0 ROOM TEMP NOT BEING CONTROLLED. NO A/C.  
87 C ITK=1, ITHST=1 ROOM TEMP FLOAT WITHIN PRESCRIBED UPPER  
88 C AND LOWER LIMITS. NO A/C WHEN WITHIN  
89 C THE LIMITS.  
90 C ITK=0, ITHST=0 EQUIPMENT CAPACITY PRESCRIBED. ROOM TEMP  
91 C FLOAT WITHIN PRESCRIBED UPPER AND LOWER  
92 C LIMITS, AND WHEN EQUIPMENT CAPACITY IS  
93 C EXCEEDED.  
94 C ITYPE(I) TYPE OF SURFACE I  
95 C = 1 ROOF  
96 C = 2 EXPOSED WALL  
97 C = 3 WINDOW  
98 C = 4 DOOR  
99 C = 5 GROUND HEAT TRANSFER SURFACE  
100 C = 6 INTERNAL MASS, FURNISHINGS, PARTY WALLS,  
101 C PARTITION WALLS, AND FLOOR/CEILINGS  
102 C = 7 OPEN PASSAGES  
103 C = 8 EXPOSED FLOOR (EXPOSED UNDERSIDE)  
104 C LAT LATITUDE, DEGREES  
105 C LONG LONGITUDE, DEGREES  
106 C LPYR LEAP YEAR INDICATOR  
107 C MONTH MONTH OF YEAR  
108 C MR(L) NUMBER OF RESPONSE FACTOR TERMS GENERA-  
109 C TED BY RESPTK FOR CONSTRUCTION L  
110 C SAME AS NR(L)  
111 C NAMEBD NAME OF ROOM  
112 C NE NUMBER OF SURFACES IN EAST WALL  
113 C NEXP TOTAL NUMBER OF SURFACES IN ROOM  
114 C = 2+NS+NW+NN+NE  
115 C NMAX HR OF THE DAY WHEN QLMAX OCCURS  
116 C NN NUMBER OF SURFACES IN NORTH WALL

117 C NOFLR NUMBER OF FLOORS  
118 C NORM NO. OF ROOMS HAVING THE SAME DATA  
119 C NR(L) NUMBER OF RESPONSE FACTOR TERMS CALCULATED BY RESPTK FOR CONSTRUCTION L  
120 C  
121 C NS NUMBER OF SURFACES IN SOUTH WALL  
122 C NW NUMBER OF SURFACES IN WEST WALL  
123 C PB BAROMETRIC PRESSURE  
124 C = 29.921 INCHES OF MERCURY  
125 C PI = 3.1415...  
126 C PV VAPOR PRESSURE, INCHES OF MERCURY  
127 C QCU MAXIMUM NUMBER OF OCCUPANTS  
128 C QDES(I) HEAT GAIN OF SURFACE I AT HOUR IMAX, BTU/HR  
129 C QDESIN(I,J) HEAT GAIN OF SURFACE I AT HOUR J, BTU/HR  
130 C  
131 C QEQPO EQUIPMENT MAXIMUM HEAT LOAD, BTU/HR  
132 C QEQPX MAXIMUM EQUIPMENT LOAD, WATTS/FT2  
133 C QEQU(J) EQUIPMENT LOAD AT HOUR J, BTU/HR  
134 C QEQUX(J) EQUIPMENT USE SCHEDULE  
135 C QGLAS(I,J) HEAT GAIN OF GLASS FOR I AT HOUR J, BTU/HR  
136 C  
137 C QGX(I) HEAT TRANSMISSION OF GLASS FOR SURFACE I AT HOUR IMAX, BTU/HR  
138 C  
139 C QI(I) INSIDE SURFACE HEAT FLUX OF SURFACE I, BTU/HR,FT2  
140 C  
141 C QISAVE(J,I) INSIDE SURFACE HEAT FLUX OF SURFACE I AT HOUR J, BTU/HR,FT2  
142 C  
143 C QLDS SUM OF LATENT AND SENSIBLE LOAD AT HOUR J, BTU/HR  
144 C  
145 C QLITE(J) LIGHT LOAD AT HOUR J, BTU/HR  
146 C QLITO MAXIMUM LIGHT LOAD, BTU/HR  
147 C QLITX(J) LIGHT USE SCHEDULE  
148 C QLITY MAXIMUM LIGHTING LOAD, WATTS/FT2  
149 C QLMAX ABSOLUTE VALUE OF THE MAX COOLING (OR HEATING) LOAD OF THE DAY, BTU/HR  
150 C  
151 C QLL(J) LATENT HEAT LOAD AT HOUR J, BTU/HR  
152 C QLS(J) SENSIBLE HEAT LOAD AT HOUR J, BTU/HR  
153 C QO(I) OUTSIDE SURFACE HEAT FLUX OF SURFACE I, BTU/HR, FT2  
154 C  
155 C QOCPS(J) OCCUPANT LOAD AT HOUR J, BTU/HR  
156 C QOCUP(J) OCCUPANT SCHEDULE  
157 C QPEOPL(J) PEOPLE LATENT LOAD AT HOUR J, BTU/HR  
158 C QPLX MAX OCCUPANT LATENT LOAD, BTU/HR,PERSON  
159 C QPSX MAX OCCUPANT SENSIBLE LOAD,BTU/HR,PERSON  
160 C QSAVE(M,J) HEAT GAINS AND LOADS AT HOUR J, BTU/HR  
161 C M = 1 TIME, HR  
162 C M = 2 SENSIBLE HEAT GAIN, BTU/HR  
163 C M = 3 LATENT HEAT GAIN, BTU/HR  
164 C M = 4 SENSIBLE LOAD, BTU/HR  
165 C M = 5 TOTAL LOAD, BTU/HR  
166 C QSKY(I,J) HEAT RADIATED TO SKY BY SURFACE I T HOUR J, BTU/HR, FT2  
167 C  
168 C QSUMT SUM OF TOTAL HEAT GAINS FOR 24 HOURS, BTU/HR  
169 C  
170 C QSUN(I,J) INCIDENT SOLAR RADIATION FOR SURFACE I AT HOUR J, BTU/HR,FT2  
171 C  
172 C QTL(J) LATENT HEAT GAIN FROM INFILTRATION AT HOUR J, BTU/HR  
173 C  
174 C QWINT HEAT LOSS IN WINTER, BTU/HR



175	C	RANGE	DAILY RANGE OF OUTDOOR DRYBULB, F	
176	C	RHIN	DESIGN INDOOR RELATIVE HUMIDITY	
177	C	RHOUT	DESIGN OUTDOOR RELATIVE HUMIDITY	
178	C	RCOMNO	RCCM NUMBER	
179	C	S	INFORMATION ARRAY REQUIRED BY SUBROU-	
180	C		TINE SUN AND GLASS	
181	C	SHADE(I)	SHADING COEFFICIENT FOR SURFACE I	
182	C	SIGMA	= 0.1714E-8	
183	C	SITELD(J)	OVERALL COOLING LOAD AT HOUR J, BTU/HR	
184	C	SITEQL(J)	OVERALL LATENT HEAT GAIN AT HOUR J,	
185	C		BTU/HR	
186	C	SITEQS(J)	OVERALL SENSIBLE HEAT GAIN AT HOUR J,	
187	C		BTU/HR	
188	C	SITETH(J)	OVERALL TOTAL HEAT GAIN AT HOUR J,	
189	C		BTU/HR	
190	C	SITMAX	OVERALL MAXIMUM HEAT GAIN, BTU/HR	
191	C	SOTHTX	OVERALL HEAT GAIN AT HOUR IMAX, BTU/HR	
192	C	SOLLD	TOTAL COOLING LOAD, BTU/HR	
193	C	SOWINT	OVERALL TOTAL HEAT LOSS, BTU/HR	
194	C	TA	ROOM AIR TEMPERATURE, F	
195	C	TASAVE(J)	RCCM AIR TEMPERATURE AT HOUR J, F	
196	C	TCLLD	DAILY RUNNING TOTAL ENERGY CONSUMPTION	
197	C		FOR COOLING FOR A GROUP (NORM OF THEM)	
198	C		OF ROOMS HAVING THE SAME CONFIGURATION,	
199	C		BTU	
200	C	TG	DESIGN SUMMER GROUND TEMPERATURE, F	>
201	C	TGW	DESIGN WINTER GROUND TEMPERATURE, F	
202	C	THTLD	DAILY RUNNING TOTAL ENERGY CONSUMPTION	
203	C		FOR HEATING FOR A GROUP (NORM OF THEM)	
204	C		OF ROOMS HAVING THE SAME CONFIGURATION,	
205	C		BTU	
206	C	TI(J)	INSIDE SURFACE TEMPERATURE RELATIVE TO	
207	C		THE REFERENCE TEMPERATURE AT HOUR J	
208	C	TIF(J)	INSIDE SURFACE TEMPERATURE AT HOUR J, F	
209	C	TIFSAV(J,I)	INSIDE SURFACE TEMPERATURE OF SUR-	
210	C		FACE I AT HOUR J, F	
211	C	TIM	INDOOR DESIGN MEAN (REFERENCE TEMPERA-	
212	C		TURE), F	
213	C	TIO	INDOOR DESIGN TEMPERATURE, F	
214	C	TIS(I,J)	INSIDE SURFACE TEMPERATURE RELATIVE TO	
215	C		THE REFERENCE TEMPERATURE OF SURFACE I	
216	C		AT HOUR J, F	
217	C	TIX(J)	INDOOR DESIGN DRYBULB TEMPERATURE AT	
218	C		HOUR J, F	
219	C	TNEW(I)	UPDATED OUTSIDE SURFACE TEMPERATURE OF	
220	C		SURFACE I AT EVERY TIME INCREMENT, F	
221	C	TNUSAV(J,I)	UPDATED OUTSIDE SURFACE TEMPERATURE	
222	C		OF SURFACE I AT HOUR J, F	
223	C	TOS(I,J)	OUTSIDE SURFACE TEMPERATURE RELATIVE TO	
224	C		REFERENCE TEMPERATURE OF SURFACE I AT	
225	C		HOUR J, F	
226	C	TOTHTX	TOTAL COOLING LOAD FOR A ROOM, BTU/HR	
227	C	TOY(J)	ARRAY USED FOR TEMPORARY STORAGE OF	
228	C		VALUES WHILE ADVANCING TEMPERATURE AS	
229	C		REQUIRED BY RESPONSE FACTOR METHOD	
230	C	TSAVE	MAXIMUM TOTAL COOLING LOAD, BTU/HR	
231	C	TSITHT	TOTAL OVERALL HEAT GAIN FOR 24 HOURS,	
232	C		BTU/HR	

233 C TV TEMPERATURE OF VENTILATING AIR, F  
234 C TZN TIME ZONE NUMBER  
235 C U(I) OVERALL HEAT TRANSFER COEFFICIENT FOR  
236 C SURFACE I  
237 C UCELNG OVERALL HEAT TRANSFER COEFFICIENT OF  
238 C THE CEILING BETWEEN THE ATTIC AIR AND  
239 C THE ROOM AIR BELOW  
240 C UENDW OVERALL HEAT TRANSFER COEFFICIENT OF  
241 C THE ATTIC ENDWALL  
242 C UG GROUND HEAT TRANSFER COEFFICIENT  
243 C UGLAS WINTER GLASS HEAT TRANSFER COEFFICIENT  
244 C UT(I) U VALUE WITHOUT SURFACE RESISTANCES  
245 C VIN INDOOR AIR SPECIFIC VOLUME, FT<sup>3</sup>/LB  
246 C VOUT OUTDOOR AIR SPECIFIC VOLUME, FT<sup>3</sup>/LB  
247 C VT(L) SAME AS UT(I)  
248 C WA OUTDOOR AIR HUMIDITY RATIO, LB OF H<sub>2</sub>O  
249 C VAPOR PER LB OF DRY AIR (= WOUT)  
250 C WAZ(I) WALL AZIMUTH ANGLE MEASURED CLOCKWISE  
251 C FROM SOUTH, DEGREES  
252 C WBID DESIGN INDOOR WETBULB TEMPERATURE, F  
253 C WJMAX DESIGN OUTDOOR WETBULB TEMPERATURE, F  
254 C WBSAVE(J) INDOOR WETBULB TEMPERATURE AT HOUR J, F  
255 C WID DESIGN INDOOR HUMIDITY RATIO, LB OF H<sub>2</sub>O  
256 C VAPOR/LB OF DRY AIR  
257 C WIN INDOOR HUMIDITY RATIO, LB H<sub>2</sub>O/LB DRY AIR  
258 C WOUT DESIGN OUTDOOR HUMIDITY RATIO, LB H<sub>2</sub>O  
259 C VAPOR/LB DRY AIR  
260 C WRDT DEGREES OF ROTATION FOR ROOM  
261 C WT WALL TILT ANGLE (= 90. DEGREES WHEN  
262 C VERTICAL WALL)  
263 C WV VENTILATION AIR HUMIDITY RATIO, LB H<sub>2</sub>O  
264 C VAPOR/LB DRY AIR  
265 C X(L,N) RESPONSE FACTORS FOR CONSTRUCTION L  
266 C XX(N,L) TRANSPOSE OF ARRAY X  
267 C Y(L,N) RESPONSE FACTORS FOR CONSTRUCTION L  
268 C YY(N,L) TRANSPOSE OF ARRAY Y  
269 C Z(L,N) RESPONSE FACTORS FOR CONSTRUCTION L  
270 C ZBLDG INPUT ARRAY FOR BUILDING AND EXTERNAL DATA  
271 C ZRCOM INPUT ARRAY FOR ROOM DATA  
272 C ZZ(N,L) TRANSPOSE OF ARRAY Z  
273 C  
274 C  
275 C CCOMMON /CC/ X(10,100),Y(10,100),Z(10,100),ITYPE(30),IHT(30),  
276 C 2 IRF(30),ABSP(30),U(30),H(30),HI(30),A(30),UT(30),TOS(30,48),  
277 C 3 TIS(30,48),G(30,30),TOY(48),DB(24),QLITX(24,3),QEQUX(24,3),  
278 C 4 QOCUP(24,3),QOCPS(24),QLITE(24),QEQUP(24),QI(30),CR(30),NR(30),  
279 C 5 QGLAS(30,24),ITHST,UENDW,AZW(30),SHADE(30),RMDBS(24),RMDBW(24),  
280 C 6 SHD(30),UCELNG  
281 C DIMENSION XX(100,10),YY(100,10),ZZ(100,10),TNEW(100),TI(48),  
282 C 2 XDUM(100),YDUM(100),ZDUM(100),TDUM(100),QQ(30),TIF(30),TOC(24),  
283 C 3 QSUN(30,24),QSKY(30,24),NAMERM(9),NAMEBD(9),VT(10),DR(10),MR(10),  
284 C 4 PR(24),PS(24),MDAYS(12)/31,28,31,30,31,30,31,31,30,31,30,31/  
285 C DIMENSION DPT(24),WBT(24),PBT(24),WST(24),TC(24),NTOC(24)  
286 C DIMENSION SALT(24),IEDAY(12)/15,46,74,105,135,166,196,227,258,288  
287 C 2,319,349/  
288 C DIMENSION CALDB(24),CALRH(24),PGLAS(30,24),PSUN(30,24),TATTIC(100)  
289 C 2,QLS(24),QLL(24),ZBLDG(15),ZROOM(12),UW(30)  
290 C DIMENSION HEATG(2),HEATX(2),HEATIS(2),HLCG(2),HLCX(2),HLCIS(2)

```

291     DIMENSION DBPF(24) / .87, .92, .96, .99,
292     2 1.00, .98, .93, .84, .71, .56, .39, .23, .11, .03,
293     3 0.0, .03, .10, .21, .34, .47, .58, .68, .76, .82/
294     COMMON /SHDW/ SHAW(30,15)
295     DIMENSION SHDX(20), SHDF(30,24), AIRLK(24), QSOL(24)
296     DIMENSION V(15), PLAT(24), AIRLAT(24), RALD(24), BASEL(24)
297     INTEGER DSTX, DSTY, RUNID, RUNTYP, ASHRAE
298     REAL LAT, LONG, NOFLR
299     INTEGER YEAR, TAPE2
300     LOGICAL LL1, LL2, LL3
301     COMMON /SOL/ LAT, LONG, TZN, WAZ, WT, CN, DSX, LPYR, S(35)
302     COMMON NSKP
303     PI=3.1415927
304     WRITE (6,1790)
305     WRITE (6,1800)
306     WRITE (6,1810)
307     WRITE (6,1820)
308     WRITE (6,1270)
309     READ (5,1460) RUNID, RUNTYP, ASHRAE, IDETAL, METHOD
310     READ (5,1640) NAMEBD
311     WRITE (6,1630) NAMEBD
312 C    READ 24 HOUR PROFILES FOR LIGHTING, EQUIPMENT AND OCCUPANCY
313     J3=3
314     DO 10 J=1, J3
315     IF (J.EQ.1) WRITE (6,1280)
316     IF (J.EQ.2) WRITE (6,1290)
317     IF (J.EQ.3) WRITE (6,1300)
318     READ (5,1460) (QLITX(I,J), I=1,24)
319     IF (J.EQ.1) WRITE (6,1310)
320     IF (J.EQ.2) WRITE (6,1320)
321     IF (J.EQ.3) WRITE (6,1330)
322     READ (5,1460) (QEQUX(I,J), I=1,24)
323     IF (J.EQ.1) WRITE (6,1340)
324     IF (J.EQ.2) WRITE (6,1350)
325     IF (J.EQ.3) WRITE (6,1360)
326     READ (5,1460) (QOCUP(I,J), I=1,24)
327 10   CONTINUE
328     IF (RUNTYP.GT.2) RUNTYP=2
329     WRITE (6,1370)
330     READ (5,1460) RMDBS
331     WRITE (6,1380)
332     READ (5,1460) RMDBW
333     WRITE (6,1390)
334     READ (5,1460) RMDBWC, RMDBSO, RHW, RHS
335     SIGMA=0.1714E-8
336     HR=4.*0.9*SIGMA*(530.**3)
337     WRITE (6,1400)
338     READ (5,1460) NDAY, NSKIP, TAPE2
339     WRITE (6,1410)
340     READ (5,1460) ZBLDG
341     CLDSUM=0.
342     HLDSUM=0.
343     DO 1260 IJKLMN=1, 10
344     WRITE (6,1420)
345     READ (5,1630) NAMERM
346 C    IF TAPE2 IS NOT BLANK B TAPE SHOULD BE ASSIGNED
347     IF (NAMERM(1).EQ.4H ) STOP
348     WRITE (6,1430)

```

```

349      READ (5,1460) IROT,ISKIP,INCLUD
350 C    IF ISKIP .NE. 0, RESPONSE FACTOR CALCULATION IS SKIPPED
351 C    SC NO WALL DATA IS NEEDED
352      IF (ISKIP.NE.0) GO TO 50
353      DO 20 I=1,10
354      DO 20 J=1,100
355      X(I,J)=0.
356      Y(I,J)=0.
357 20   Z(I,J)=0.
358      IF (RUNID.EQ.1) GO TO 30
359      READ (8) X,Y,Z,MR,DR,VT
360      GO TO 40
361 C    THIS RESPONSE FACTOR ROUTINE REQUIRES MANY CONSTRUCTION DATA
362 C    PLEASE REFER TO THE INPUT INSTRUCTIONS
363 30   CONTINUE
364      CALL RESFX (X,Y,Z,XX,YY,ZZ,MR,DR,VT,10)
365      WRITE (8) X,Y,Z,MR,DR,VT
366      END FILE 8
367 40   PB=29.921
368 50   IF (IROT.NE.0) GO TO 60
369      WROT=0.
370      WRITE (6,1440)
371      READ (5,1460) ZRCOM
372      WRITE (6,1450)
373      READ (5,1460) IW,IL,ISTART,ILEAVE
374      READ (5,1460) TUL,TLL,QCMAX,QHMAX,DBVMAX,DBVMIN
375      READ (5,1460) ITHST,ITK
376      CALL ROCMX (NEXP,NS,NW,NN,NE,HT)
377      ROOMNO=ZRCOM(1)
378      MONTH=ZBLDG(1)
379      AG=A(NEXP)
380      NOFLR=1
381      QCU=ZROOM(4)
382      LAT=ZBLDG(12)
383      LONG=ZBLDG(11)
384      TZN=ZBLDG(13)
385      DAYSKP=NSKIP
386      QLITY=ZROOM(2)
387      QEGPX=ZROOM(3)
388      CFMV=ZRCOM(8)
389      WPMAX=ZBLDG(6)
390      FLCG=ZRCOM(5)
391      TGS=ZBLDG(8)
392      TGW=ZBLDG(9)
393      LDAY=ZBLDG(2)
394      YEAR=2000
395      DBWT=ZBLDG(7)
396      DBMAX=ZBLDG(4)
397      RHOW=ZBLDG(15)
398      ZLF=ZBLDG(14)
399      DBIN=RMDBW(12)
400      RHIN=RHW
401      IF (RUNTYP.EQ.2) CALL PSY1 (DBMAX,WPMAX,PB,DPMAX,PV,WA,HA,VA,RHO)
402      UG=ZBLDG(10)
403      TV=ZROOM(7)
404      FRAS=ZROOM(6)
405      ZNORM=ZROOM(12)
406      ARCHGW=ZROOM(10)

```

```

407      CFMWT=AG*HT*ARCHGW/60.
408      ARCHGM=ZROOM(11)
409      CFMIN=AG*HT*ARCHGM/60.
410      CONST=ARCHGW/0.695
411  C     THESE AIR CHANGE VALUES ARE FOR THE ATTIC VENTILATION
412  C     ROOM AIR CHANGE VALUES WILL BE DETERMINED AS A FUNCTION OF
413  C     WIND SPEED AND TEMPERATURE DIFFERENTIAL
414  60    CONTINUE
415      WRITE (6,1510)
416      IF (IDETAL.EQ.0) GO TO 70
417      WRITE (6,1550)
418      WRITE (6,1560) RCCMNO,HT,AG,NOFLR,QCU,ZROOM(9),ZROOM(10)
419      WRITE (6,1740)
420  70    CONTINUE
421      S(1)=LAT
422      S(2)=LONG
423      S(3)=TZN
424      IF (IDETAL.EQ.0) GO TO 80
425      WRITE (6,1570)
426      WRITE (6,1560) LAT,LONG,TZN,ZNORM
427      WRITE (6,1740)
428      WRITE (6,1580)
429      RHIN=RHS
430      WRITE (6,1560) QLITY,QEQPX,CFMV,DBIN,TGW,TV,RHIN
431      WRITE (6,1740)
432      WRITE (6,1600) NEXP,ITK,ITHST
433  80    CONTINUE
434      WRITE (6,1510)
435      IF (IROT.NE.0) GO TO 90
436      WRITE (6,1470)
437      READ (5,1460) UENDW,UCELNG,AENDW,ATCHT,AIRCHG,AIRNT
438      WRITE (6,1480)
439      READ (5,1460) IEXTSD,IEXMS,IEXME,NTVNT,NVENT
440      CFMNT=NTVNT*AG*HT/60.
441  90    CONTINUE
442      IF (IDETAL.EQ.0) GO TO 100
443      WRITE (6,1740)
444      WRITE (6,1590)
445      WRITE (6,1560) UENDW,UCELNG,AENDW,ATCHT
446  100   CONTINUE
447      IF (IROT.NE.0) GO TO 210
448      SUM=0.
449      DO 200 I=1,NEXP
450      K=IRF(I)
451      IF (Y(K,1).GT.1.) IRF(I)=10
452      NR(I)=MR(K)
453      IF(IRF(I).EQ.10)NR(I)=1
454      UT(I)=VT(K)
455      CR(I)=DR(K)
456      IF (NR(I).EQ.0) NR(I)=1
457      IF (NR(I).GT.48) NR(I)=48
458      IF (ITYPE(I).EQ.3) ABSP(I)=0.
459      IF (ITYPE(I).EQ.5) ABSP(I)=0.
460      IF (ITYPE(I).GE.6) ABSP(I)=0.
461      IHT(I)=1
462      IF (ITYPE(I).EQ.3) IHT(I)=-1
463      H(I)=6.0
464      HI(I)=1.46-HR

```



```

465      IF ( ITYPE(I).GE.5 ) H(I)=0.
466      IF ( ITYPE(I).EQ.1 ) HI(I)=1.630-HR
467      IF ( ITYPE(I).EQ.5 ) HI(I)=1.080-HR
468      IF ( ITYPE(I).EQ.7 ) U(I)=500.
469      IF ( ITYPE(I).EQ.8 ) H(I)=1.46
470      IF ( IRF(I).NE.10 ) U(I)=0.
471      IF ( U(I) ) 110,110,120
472 110    RU=1./UT(I)+1./HI(I)+HR
473      IF ( ITYPE(I).LT.5.OR.ITYPE(I).EQ.8 ) RU=RU+1./H(I)
474      U(I)=1./RU
475 120    CONTINUE
476      IF ( X(K,2) ) 170,130,170
477 130    IF ( H(I) ) 140,150,140
478 140    R=1./U(I)-1./H(I)
479      GO TO 160
480 150    R=1./U(I)
481 160    UT(I)=1./(R-1./HI(I)+HR)
482      IF ( UT(I).LE.0. ) UT(I)=28.0
483      IF ( ITYPE(I).EQ.7 ) UT(I)=500.
484 170    CONTINUE
485      IF ( UCELNG ) 190,190,180
486 180    IF ( ITYPE(I).NE.1 ) GO TO 190
487      RTA=1./UCELNG-1./HI(I)+HR
488      UT(I)=1./RTA
489 190    CONTINUE
490      UW(I)=U(I)
491      IF ( ITYPE(I).GT.4 ) GO TO 200
492      SUM=SUM+A(I)*U(I)
493 200    CONTINUE
494      IF ( ZLF.EQ.0. ) ZLF=1.
495      ZK=SUM/ZLF
496      FC=1.-0.02*ZK
497 210    IF ( IROT.EQ.0 ) GO TO 240
498      WROT=IROT
499      DO 220 I=1,NEXP
500      AZW(I)=AZW(I)+WROT
501      IF ( AZW(I).LT.-180. ) AZW(I)=AZW(I)+360.
502 220    IF ( AZW(I).GT.180. ) AZW(I)=AZW(I)-360.
503      DO 230 I=1,NEXP
504      DO 230 J=1,NEXP
505 230    G(I,J)=G(I,J)/HR
506 240    CONTINUE
507      IF ( IDETAL.EQ.0 ) GO TO 280
508      WRITE (6,1680)
509      DO 250 I=1,NEXP
510      WRITE (6,1650) I,ITYPE(I),IHT(I),IRF(I),ABSP(I),U(I),H(I),A(I),AZW
511 2(I),SHADE(I),UT(I),HI(I)
512 250    CONTINUE
513      WRITE (6,1690)
514      DO 260 I=1,NEXP
515 260    WRITE (6,1560) (SPAW(I,J),J=1,15)
516      IF ( ASHRAE.EQ.1 ) GO TO 300
517      WRITE (6,1700)
518      WRITE (6,1710)
519      DO 270 I=1,NEXP
520      WRITE(6,1720)I,(G(I,J),J=1,NEXP)
521 270    CONTINUE
522 280    DO 290 I=1,NEXP

```



```

523      DO 290 J=1,NEXP
524 290      G(I,J)=HR*G(I,J)
525 300      TIM=75.
526          IF (RUNTYP.EQ.2) CALL WINTER (A,UW,ITYPE,NEXP,CFMWT,DBIN,DBWT,UG,T
527 2GW,RHW,RHOW,UENDW,UCELNG,AENDW,ATCHT,AIRCHG)
528          QLITC=QLITY*AG*3.413*NOFLR
529          QEQPO=QEQPX*AG*3.413*NOFLR
530      DO 310 I=1,NEXP
531          QO(I)=0.
532          QI(I)=0.
533 310      CONTINUE
534          QRFC=0.
535          QRFI=0.
536  C      DBM=TIM= REFERENCE TEMPERATURE
537          TA=TIM
538          MOT=0
539          TCLLD=0.
540          THTLD=0.
541          IF (IJKLMN.GT.1) GO TO 320
542 320      CONTINUE
543          NEND=DAYSKP+NDAY
544          IF (RUNTYP.NE.2) GO TO 340
545          NEND=7
546          DO 330 J=1,24
547          DB(J)=ZBLDG(4)-ZBLDG(5)*DBPF(J)
548          DPT(J)=DPMAX
549          WST(J)=0.
550          PBT(J)=29.921
551          TC(J)=0.
552          NTOC(J)=0
553 330      CONTINUE
554 340      DO 1250 ND=1,NEND
555          NSKP=ND-DAYSKP
556          IF (RUNTYP.EQ.2) GO TO 380
557          READ (7) DB,DPT,WBT,WST,PBT,TC,TOC,PR,PS,YEAR,MCNTH,LDAY,ICITY
558          DO 350 IZ1=1,24
559          NTOC(IZ1)=TOC(IZ1)
560 350      CONTINUE
561          N=ND-DAYSKP
562          IF (N.LT.1) GO TO 1250
563          INDAY=DAYSKP+N
564          IF (IDETAL.EQ.0) GO TO 360
565          WRITE (6,1620) N,INDAY,YEAR,MONTH,LDAY
566          WRITE (6,1610) NAMERM
567 360      CONTINUE
568          KDAY=WKDAY(YEAR,MONTH,LDAY)
569          CALL HCLDAY (YEAR,MONTH,LDAY,KDAY,IHOL)
570          CALL DST (YEAR,MONTH,LDAY,DSTX,DSTY)
571          IDST=1
572          IF (MONTH.LT.4) IDST=0
573          IF (MONTH.GT.10) IDST=0
574          IF (MONTH.NE.4.OR.MONTH.NE.10) GO TO 370
575          IF (MONTH.EQ.4.AND.LDAY.LT.DSTX) IDST=0
576          IF (MONTH.EQ.10.AND.LDAY.GT.DSTY) IDST=0
577 370      DSX=IDST
578          JJ=1
579          IF (KDAY.EQ.7.OR.KDAY.EQ.1) JJ=2
580          IF (IHOL.EQ.1) JJ=2

```

```

581 380 IF (RUNTYP.EQ.2) JJ=1
582 DO 390 J=1,24
583 QLITE(J)=QLITO*QLITX(J,JJ)
584 QECUP(J)=QEQPO*QEQUX(J,JJ)
585 390 CONTINUE
586 IF (MONTH.EQ.MOT) GO TO 550
587 TG=TGW
588 IF (MONTH.GT.5.AND.MONTH.LT.10) TG=TGS
589 MCT=MONTH
590 S(4)=IEDAY(MCNTH)
591 IF (RUNTYP.EQ.2) S(4)=ZBLDG(3)
592 S(6)=IDST
593 IF (RLNTYP.EQ.2) S(6)=0.
594 S(7)=0.2
595 S(8)=1.0
596 S(33)=1.
597 IF (IDETAL.EQ.0) GO TO 400
598 WRITE (6,1730)
599 400 CONTINUE
600 DO 530 I=1,NEXP
601 IF (ITYPE(I).LT.5) GO TO 420
602 DO 410 J=1,24
603 QSUN(I,J)=0.
604 QGLAS(I,J)=0.
605 410 QSKY(I,J)=0.
606 GO TO 520
607 420 WAZ=AZW(I)
608 S(9)=WAZ
609 S(10)=90.
610 IF (ITYPE(I).EQ.1) S(10)=0.
611 SHDX(1)=SHAW(I,1)
612 SHDX(2)=SHAW(I,2)
613 SHDX(3)=SHAW(I,3)
614 SHDX(4)=SHAW(I,4)
615 SHDX(5)=SHAW(I,5)
616 SHDX(6)=SHAW(I,6)
617 SHDX(7)=SHAW(I,7)
618 SHDX(8)=SHAW(I,8)
619 SHDX(9)=SHAW(I,9)
620 SHDX(10)=SHAW(I,10)
621 SHDX(11)=SHAW(I,11)
622 SHDX(12)=SHAW(I,12)
623 SHDX(13)=SHAW(I,13)
624 SHDX(14)=SHAW(I,14)
625 SHDX(15)=SHAW(I,15)
626 430 CONTINUE
627 DO 510 J=1,24
628 QSKY(I,J)=0.
629 TIME=J
630 S(5)=TIME
631 CALL SUN
632 SALT(J)=S(20)
633 IF (S(25).GT.0.) GO TO 440
634 QSUN(I,J)=0.
635 QGLAS(I,J)=0.
636 GO TO 510
637 440 QSUN(I,J)=S(25)*ABSP(I)
638 QGLAS(I,J)=0.

```

```

639      PHI=S(21)*PI/180.
640      XQ=S(20)*PI/180.
641      CGSZ=SIN(XQ)
642      IF (SHD(I)) 460,460,450
643 450   SHDF(I,J)=0.
644      GO TO 480
645 460   SHDF(I,J)=1.
646      IF (SHDX(1)) 480,480,470
647 470   SHDX(16)=S(9)*PI/180.
648      CALL SHADOW (SHDX,PHI,COSZ,SHDF(I,J))
649 480   CONTINUE
650      IF (ITYPE(I).NE.3) GO TO 500
651      IF (IEXTSD.EQ.0) GO TO 490
652      IF (MONTH.GE.IEXMS.AND.MONTH.LE.IEXME) SHDF(I,J)=0.
653 490   CONTINUE
654      CALL GLASS (SHDF(I,J),SHADE(I),1.,1.,QGLAS(I,J))
655 500   CONTINUE
656      S34=S(25)-S(26)-S(27)
657      QSUN(I,J)=(S34*SHDF(I,J)+S(26)+S(27))*ABSP(I)
658 510   CONTINUE
659 520   IF (IDETAL.NE.0) WRITE (6,1660) I
660      IF (IDETAL.NE.0) WRITE (6,1670) (QSUN(I,J),J=1,24)
661      IF (IDETAL.NE.0) WRITE (6,1670) (QGLAS(I,J),J=1,24)
662 530   CONTINUE
663      DO 540 I=1,NEXP
664      DO 540 J=1,24
665      PGLAS(I,J)=QGLAS(I,J)
666 540   PSUN(I,J)=QSUN(I,J)
667 550   CONTINUE
668      IF (ND.NE.1) GO TO 640
669      DO 560 J=1,24
670      DO 560 I=1,NEXP
671 560   TOS(I,J)=DB(24-J+1)-TIM
672      DO 570 J=25,48
673      DO 570 I=1,NEXP
674 570   TOS(I,J)=TOS(I,J-24)
675      DO 580 I=1,NEXP
676      DO 580 J=1,48
677 580   TIS(I,J)=0.
678      TA=TIM
679      DO 590 J=1,48
680      TNEW(J)=0.
681 590   TATTIC(J)=0.
682      IF (ASHRAE) 640,640,600
683 600   DO 620 I=1,NEXP
684      DO 610 J=1,24
685 610   TIS(I,J)=RMDBS(24-J+1)-TIM
686      DO 620 J=25,48
687 620   TIS(I,J)=TIS(I,J-24)
688      DO 630 II=1,2
689      HEATG(II)=0.
690      HEATX(II)=0.
691      HEATIS(II)=0.
692      HLCG(II)=0
693      HLCX(II)=0.
694 630   HLCIS(II)=0.
695 640   CONTINUE
696 C     END OF INITIALIZATION

```

```

697 C      TIME CALCULATION BEGINS HERE
698      DO 1150 NK=1,24
699      LL1=NK.GE.ISTART.AND.NK.LE.ILFAVE
700      LL2=NK.LT.ISTART.OR.NK.GT.ILEAVE
701      LL3=NVENT.NE.0.AND.DB(NK).LT.TV.AND.QL.LT.10.
702      IF (ITK.NE.0) GO TO 650
703      IF (ITHST.NE.1) GC TO 650
704      CALL TEMPSH (MONTH, JJ, NK, RMDBS, RMDBW, RMDBWO, RMDBSO, TA)
705 650     CONTINUE
706      IF (RUNTYP.NE.2) GC TO 660
707      FOT=4.
708      ACHG=ZROOM(9)
709      CM=1.
710      GO TO 670
711 660     WSTX=WST(NK)
712      CALL FC (WSTX,3,F0C,FOT,0)
713 C      AIR CHANGE AS A FUNCTION OF WIND SPEED
714 C      COBLENZ AND ACHENBACH 1963 ASHRAE TRANSACTION
715      WSTZ=WST(NK)*1.151
716      ACH=0.15+0.013*WSTZ+0.005*ABS(DB(NK)-TA)
717      ACHG=ACH*CONST
718      CM=CCM(SALT(NK),NTOC(NK),TC(NK))
719 670     CFML=A(1)*ACHG*HT/60.+CFMIN
720      CFMLX=CFML
721      IF (LL1) GO TO 680
722      CFMV=0.
723      GO TO 690
724 680     IF (JJ.GT.1) CFMV=0.
725 690     CONTINUE
726      DO 720 I=1,NEXP
727      NRR=NR(I)
728      QSUN(I,NK)=PSUN(I,NK)*CM
729      QGLAS(I,NK)=PGLAS(I,NK)*CM
730      QSKY(I,NK)=0.
731      IF (ITYPE(I).EQ.1) QSKY(I,NK)=2.*(10.-TC(NK))
732      IF (NRR.LT.2) GO TO 720
733      DO 700 NTT=2,NRR
734 700     TOY(NTT)=TOS(I,NTT-1)
735      DO 710 NTT=2,NRR
736 710     TOS(I,NTT)=TOY(NTT)
737 720     CONTINUE
738      DO 800 I=1,NEXP
739      NRR=NR(I)
740      IF (ASHRAE.GT.0) TIS(I,1)=TA-TIM
741      K=IRF(I)
742      DO 730 J=1,NRR
743      XDUM(J)=X(K,J)
744      YDUM(J)=Y(K,J)
745      ZDUM(J)=Z(K,J)
746      TDUM(J)=TOS(I,J)
747      IF (ITYPE(I).EQ.6.OR.ITYPE(I).EQ.7) TDUM(J)=TIS(I,J)
748      IF (ITYPE(I).EQ.5) TDUM(J)=TG-TIM
749      TI(J)=TIS(I,J)
750 730     CONTINUE
751      UX=U(I)
752      IF (H(I)) 750,750,740
753 740     H(I)=FOT
754      RX=1./UT(I)+1./((HI(I)+FR)

```

```

755      RXX=RX+1./H(I)
756      U(I)=1./RXX
757      UX=1./RX
758 750   CONTINUE
759      IF (ITYPE(I).EQ.1.AND.UENDW.NE.0.) GO TO 760
760      GC TO 780
761 760   ATCACG=AIRCTG*AIRNT
762      IF (LL1) ATCACG=AIRCTG
763      CALL ATTIC (XDUM,YDUM,ZDUM,CR(I),NRR,UX,H(I),DB(NK),QSUN(I,NK),QSK
764 2Y(I,NK),TDUM,TATTIC,TNEW,TA,TIM,QRFO,QRFI,QO(I),QI(I),UENDW,UCELN
765 3G,AENDW,A(I),ATCMT,ATCACG)
766      DO 770 J=1,NRR
767      TNEW(J)=TDUM(J)
768 770   TOS(1,J)=TATTIC(J)
769      GC TO 800
770 780   CONTINUE
771      IF (RUNTYP.EQ.2) ITEMP=0
772      CALL OUTSID (XDUM,YDUM,ZDUM,CR(I),UX,H(I),DB(NK),TIM,QO(I),QI(I),Q
773 2SUN(I,NK),QSKY(I,NK),TDUM,TI,TNEW,TA,NRR)
774      DO 790 J=1,NRR
775 790   TOS(I,J)=TDUM(J)
776 800   CONTINUE
777      QDCPS(NK)=QDCUP(NK,JJ)*10.*(100.-TA)*QCU
778      QDCPL=10.*(TA-60.)*QDCUP(NK,JJ)*QCU
779      IF (TA-100.) 820,810,810
780 810   QDCPS(NK)=0.
781      QDCPL=400.*QDCUP(NK,JJ)*QCU
782      GO TO 840
783 820   IF (TA-65.) 830,840,840
784 830   QDCPS(NK)=350.*QDCUP(NK,JJ)*QCU
785      QDCPL=50.*QDCUP(NK,JJ)*QCU
786 840   DO 870 I=1,NEXP
787      NRR=NR(I)
788      IF (NRR.LT.2) GO TO 870
789      DO 850 NTT=2,NRR
790 850   TOY(NTT)=TIS(I,NTT-1)
791      DO 860 NTT=2,NRR
792 860   TIS(I,NTT)=TCY(NTT)
793 870   CONTINUE
794      IF (ASHRAE) 900,900,880
795 880   QSUMG=0.
796      QSUMX=0.
797      DO 890 I=1,NEXP
798      IF (ITYPE(I).LE.3.OR.ITYPE(I).EQ.8) QSUMX=QSUMX-QI(I)*A(I)
799      IF (ITYPE(I).EQ.3) QSUMG=QSUMG+QGLAS(I,NK)*A(I)
800 890   CCNTINUE
801      HEATG(1)=HEATG(2)
802      HEATG(2)=QSUMG
803      HEATX(1)=HEATX(2)
804      HEATX(2)=QSUMX+GCCFS(NK)+QEQU(NK)
805      HEATIS(1)=HEATIS(2)
806      NKK=NK-1
807      IF (NKK.EQ.0) NKK=24
808      HEATIS(2)=QLITE(NKK)
809      HLCG(1)=FLCG(2)
810      HLCX(1)=HLCX(2)
811      HLCIS(1)=HLCIS(2)
812      ISC=1

```

```

813      CALL RMRT (HEATG,FLCG,HEATX,HLCX,HEATIS,HLCIS,IW,IL,FC,ISC)
814      QL=HLCG(2)+HLCX(2)+HLCIS(2)+1.08*CFML*(DB(NK)-TA)
815      QGAIN=HEATG(2)+HEATX(2)+HEATIS(2)
816      QL=-QL
817      GO TO 965
818 900    CONTINUE
819      DO 960 I=1,NEXP
820      HI(I)=0.542
821      HTEST=TIS(I,1)
822      IF (I.NE.1) GO TO 930
823      IF (HTEST) 910,910,920
824 910    HI(1)=0.712
825      GO TO 960
826 920    HI(1)=0.162
827      GO TO 960
828 930    IF (I.NE.NEXP) GO TO 960
829      IF (HTEST) 940,940,950
830 940    HI(NEXP)=0.162
831      GO TO 960
832 950    HI(NEXP)=0.712
833 960    CONTINUE
834 965    CONTINUE
835      IF (NTVNT.EQ.0) GO TO 1010
836      IF (DB(NK).LT.DBVMIN.OR.DB(NK).GT.DBVMAX ) GO TO 1010
837 970    IF (TA-DB(NK)) 1010,1010,980
838 980    IF (JJ.GT.1) GO TO 990
839      IF (LL1) GO TO 1010
840 990    IF (QL+10) 1000,1010,1010
841 1000   CFML=CFMLX+CFMNT
842 1010   CONTINUE
843      V(3)=0.
844      V(2)=CFML
845      V(1)=DB(NK)
846      IF (LL2 .CR. .NOT.LL3 .OR.JJ.GT.1)GO TO 1011
847      V(3)=CFMV
848 1011   CONTINUE
849      CFMLNC=CFML+V(3)
850      IF (ASHRAE.GT.0.)GO TO 1040
851      V(4)=FRAS
852      V(5)=FLCG
853      V(6)=TIM
854      V(7)=QC MAX
855      V(8)=GH MAX
856      IF (JJ.GT.1) GO TO 1020
857      IF (LL2) GO TO 1020
858      V(9)=TUL
859      V(10)=TLL
860      GO TO 1030
861 1020   V(9)=RMDBSO
862      V(10)=RMDBWO
863 1030   CONTINUE
864      V(11)=TA
865      V(12)=FRAS
866      V(13)=HR
867      V(14)=METHOD
868      CALL RMTMK (V,TIF,QL,TA,NEXP,NK,ITK)
869      IF (LL1 .AND.LL3 .AND.QL.GT.0..AND.DB(NK).GT.60.)QL=0.
870 1040   CALL PSY2 (DB(NK),DPT(NK),PBT(NK),WBT(NK),PVO,WA,HA,VA,RHA)

```



```

871      IF (ABS(QL).LT.10.)QL=0.
872      PLAT(NK)=-QOCPL*ZNORM
873      WV=WA
874      QOCPL=QOCPL/1060.
875 1080  WIN=(4.5*CFMLNC*WA+QOCPL)/4.5/CFMLNC
876      PVI=PB*WIN/(0.622+WIN)
877      RHIN=100.*PVI/PVSF(TA)
878      IF (RHIN.GT.100)RHIN=100.
879      IF (QL.EQ.0.)GO TO 1086
880      IF (QL.GT.0.)GO TO 1085
881      IF (RHIN.GT.RHS)RHIN=RHS
882 1085  IF (QL.LT.0.)GO TO 1086
883      IF (RHIN.LT.RHW)RHIN=RHW
884 1086  CONTINUE
885      CALDB(NK)=TA
886      CALRH(NK)=RHIN
887      CALL DBRH (TA,RHIN,WIN)
888      AIRLAT(NK)=4.5*CFMLNC*(WIN-WA)*1060.*ZNORM
889      RALD(NK)=QLITE(NK)*FLCG*ZNORM
890      BASEL(NK)=(QLITE(NK)+QEQUP(NK))*ZNORM
891      AIRLK(NK)=1.08*CFMLNC*(TA-DB(NK))*ZNORM
892      QSOL(NK)=PSUN(1,NK)
893      QLATNT=(4.5*CFMLNC*(WIN-WA)-QOCPL)*1060.
894      IF ((QL.GT.0..AND.RHIN.GT.RHW).OR.(QL.LT.0..AND.RHIN.LT.RHS))
895 1QLATNT=0.
896      IF (RUNTYP.EQ.2) GO TO 1100
897      IF (ASHRAE.EQ.0) GO TO 1100
898      CALL ADJUST (QL,QLATNT,MONTH,NK,JJ)
899 1100  CONTINUE
900  C
901      QLS(NK)=QL*ZNORM
902      QLL(NK)=QLATNT*ZNORM
903      IF (ABS(QLS(NK))-1.) 1110,1110,1120
904 1110  QLL(NK)=0.
905 1120  CONTINUE
906      IF (UENDW) 1150,1150,1130
907 1130  NRR=NR(1)
908      DO 1140 J=1,NRR
909 1140  TOS(1,J)=TNEW(J)
910 1150  CONTINUE
911      IF (RUNTYP.EQ.2.AND.ND.LT.7) GO TO 1250
912      QLMAX=ABS(QLS(1))
913      NMAX=1
914      TSUM=0.
915      QLDSUM=0.
916      CLDAY=0.
917      HLDAY=0.
918      DO 1200 NK=1,24
919      IF (QLMAX-ABS(QLS(NK))) 1160,1170,1170
920 1160  QLMAX=ABS(QLS(NK))
921      NMAX=NK
922      GO TO 1170
923 1170  CONTINUE
924      TSUM=TSUM+DB(NK)
925      QLDSUM=QLDSUM+QLS(NK)+QLL(NK)
926      QLDS=QLS(NK)+QLL(NK)
927      IF (QLDS) 1180,1180,1190
928 1180  CLDAY=CLDAY+QLDS

```

```

929      GO TO 1200
930 1190  HLDAY=HLDAY+QLDS
931 1200  CONTINUE
932      TCLLD=TCLLD+CLDAY
933      THTL D=THTLD+HLDAY
934      DBA=TSUM/24.
935      QLMAX=QLS(NMAX)+QLL(NMAX)
936      IF (RUNTYP.EQ.2) N=1
937      IF (N.GT.1) GO TO 1210
938      WRITE (6,1520) NAMERM,MONTH
939 1210  CONTINUE
940      WRITE (6,1530) MONTH,LDAY,NMAX,QLMAX,CLDAY,HLDAY,DBA
941      IF (MOD(YEAR,4).EQ.0)MDAYS(2)=29
942      TMTTH=TMTTH+HLDAY
943      TMTHC=TMTHC+CLDAY
944      IF (QLMAX.LT.YMAXH)GO TO 1207
945      YMAXH=QLMAX
946      NMAXH=NMAX
947      LDAYH=LDAY
948      LMH=MONTH
949 1207  IF (QLMAX.GT.YMAXC)GO TO 1208
950      YMAXC=QLMAX
951      NMAXC=NMAX
952      LDAYC=LDAY
953      LMC=MONTH
954 1208  IF (LDAY.NE.MDAYS(MONTH))GO TO 1209
955      WRITE(6,1271)TMT+C,TMTTH
956      TMTHC=0.
957      TMTFH=0.
958      IF (ND.EQ.NEND)GO TO 1209
959      WRITE(6,1272)
960 1209  CONTINUE
961      IF (ND.EQ.NEND) WRITE (6,1510)
962      IF (RUNTYP.NE.2) GO TO 1230
963      IF (ND.NE.NEND) WRITE (6,1510)
964      WRITE (6,1540) YEAR,MONTH,LDAY
965      WRITE (6,1490)
966      DO 1220 J=1,24
967 1220  WRITE (6,1500) J,DB(J),WBT(J),CALDB(J),CALRH(J),QLS(J),QLL(J)
968      WRITE (6,1510)
969 1230  CONTINUE
970      IF (IDETAL.EQ.0) GO TO 1240
971      WRITE (6,1750) DBA,QLDSUM
972      WRITE (6,1760) CLDAY,HLDAY
973      WRITE (6,1770) N,TCLLD,N,THTLD
974 1240  CONTINUE
975      IF (TAPE2.EQ.0) GC TO 1250
976      WRITE (TAPE2) NAMERM,MONTH,LDAY,DB,DPT,WBT,WST,PBT,TC,NTOC,CALDB,C
977 2ALRH,QLS,QLL,DBA,CLDAY,HLDAY,TCLLD,THTLD,QLITE,QEQU,QSOL,QOCPS,AI
978 3RLK
979      WRITE (10) QLS,PLAT,AIRLAT,DB,DPT,CALDB,RALD,BASEL
980 1250  CONTINUE
981      CLDSUM=CLDSUM+TCLLD
982      HLDSUM=HLDSUM+THTLD
983      WRITE(6,1273)YMAXC,LMC,LDAYC,NMAXC,YMAXH,LMH,LDAYH,NMAXH
984      WRITE (6,1780) IJKLMN,CLDSUM,IJKLMN,HLDSUM
985      REWIND 7
986 1260  CONTINUE

```

```

987      END FILE TAPE2
988      END FILE 10
989      STOP
990  C
991  C
992  1271  FORMAT(//' MONTHLY COOLING LOAD=',E15.8,' BTU',//' MONTHLY HEATING
993      * LOAD=',E15.8,' BTU')
994  1272  FORMAT(1H1,' MONTH DAY',7X,' MHR   QLMAX',5X,' CLDAY',5X,' HLDAY',7X,
995      *'DEA')
996  1273  FORMAT(' MAX COOLING LOAD =',F10.0,' MONTH =',I3,' DAY =',I3,' HOU
997      *R =',I3,'/ MAX HEATING LOAD =',F10.0,' MCNTH =',I3,' DAY =',I3,' H
998      *OUR =',I3)
999  1270  FORMAT (//34H RUNID,RUNTYP,ASHRAE,IDETAL,METHOD/41H RUNID.....
1000      2IDENTIFICATION OF THE RUN /42H          1 NEED RESPONSE FACTO
1001      3R DATA/42H          2 SKIP RESPONSE FACTOR DATA/26H RUNTYP...
1002      4.....TYPE OF RUN/56H          1 ENERGY CALCULATION ..NEEDS WE
1003      5ATHER TAPE/40H          2 DESIGN LOAD CALCULATION/52H
1004      6          3 DESIGN AND ENERGY LOAD CALCULATIONS/28H ASHRAE.....0
1005      7 USE RMTMP/47H          1 USE ASHRAE WEIGHTING FACTORS/37H
1006      8IDETAL.....0 NO DETAILED OUTPUT/34H          1 DETAILE
1007      9D OUTPUT/49H METHCD.....0 REGULAR TREATMENT FOR THE ROOM/48H.
1008      *.....1 SPECIAL TREATMENT OF THE ROOM)
1009  1280  FORMAT (31H LIGHTING SCHEDULE FOR WEEKDAYS)
1010  1290  FORMAT (30H LIGHTING SCHEDULE FOR WEEKEND)
1011  1300  FORMAT (42H LIGHTING SCHEDULE FOR THE VACATION PERIOD)
1012  1310  FORMAT (38H EQUIPMENT USAGE SCHEDULE FOR WEEKDAYS)
1013  1320  FORMAT (32H EQUIPMENT SCHEDULE FOR WEEKENDS)
1014  1330  FORMAT (49H EQUIPMENT USAGE SCHEDULE FOR THE VACATION PERIOD)
1015  1340  FORMAT (32H OCCUPANCY SCHEDULE FOR WEEKDAYS)
1016  1350  FORMAT (31H OCCUPANCY SCHEDULE FOR WEEKEND)
1017  1360  FORMAT (43H OCCUPANCY SCHEDULE FOR THE VACATION PERIOD)
1018  1370  FORMAT (42H THERMCSTAT SETTING FOR THE COOLING SEASON)
1019  1380  FORMAT (42H THERMOSTAT SETTING FOR THE HEATING SEASON)
1020  1390  FORMAT (22H RMDWVC,RMDBSO,RHW,RHS)
1021  1400  FORMAT (33H DATA SHEET NO 1:NDAY,NSKIP,TAPE2)
1022  1410  FORMAT (56H DATA SHEET NO 2 +3 :MONTH,DAY,ELAPS,DBMAX,RANGE,WBMAX,
1023      2 DEMWT,TGS,TGW,UG,LONG,LAT,TZN,ZLF,RHOW)
1024  1420  FORMAT (34H DATA SHEET NO 4: NAME OF THE ROOM)
1025  1430  FORMAT (35H DATA SHEET NO 5:IROT,ISKIP,INCLUDE)
1026  1440  FORMAT (85H DATA SHEET NO 8: ROOMNO,QLITY,REQPY,QCU,FLCG,FRAS,TS,C
1027      2FMV,ARCHGS,ARCHGW,ARCHGM,ZNORM)
1028  1450  FORMAT (53H DATA SHEET NO.9: IW,IL,TUL,TLL,QCMAX,QHMAX,ITHST,ITK)
1029  1460  FORMAT ()
1030  1470  FORMAT (56H DATA SHEET NO 13: UENDW,UCELNG,AENDW,ATCHT,AIRCHG,AIRN
1031      2T)
1032  1480  FORMAT (49H DATA SHEET NO 14: IEXTSD,IEXMS,IEXME,NTVNT,NVENT//)
1033  1490  FORMAT (//69H TIME DBOUT WBOU DBIN RHIN
1034      2 G S QLL)
1035  1500  FORMAT (I10,4F10.1,2F10.0)
1036  1510  FORMAT (///)
1037  1520  FORMAT (///14H ROOM NAME= 9A4,9H MONTH= I6/56H DAY
1038      2MHR QLMAX CLDAY HLDAY DBA)
1039  1530  FORMAT (I4,I6,I10,3F10.0,F10.1)
1040  1540  FORMAT (13H ***** YEAR =,I5,14H ***** MONTH =,I3,12H ***** DAY =,I
1041      23/)
1042  1550  FORMAT (8H RCCMNO,6X2HHT,6X2HAG,3X5HNOFLR,5X3HQCU,2X6HARCHGS,2X6H
1043      2ARCHGW)
1044  1560  FORMAT (15F8.1)

```

```

1045 1570 FORMAT (5X3HLAT,4X4HLONG,5X3HTZN,3X5HZNORM)
1046 1580 FORMAT (3X5HQLITY,3X5HQEQPX,4X4HCFMV,4X4HDBIN,6X2HTG,6X2HTV,4X4HRH
1047      2IN)
1048 1590 FORMAT (/31H UENDW UCELNG AENDW ATCHT)
1049 1600 FORMAT (6X,4HNEXP,7X,3HITK,5X,5HITHST/3(8X,I2))
1050 1610 FORMAT (1H ,6A6)
1051 1620 FORMAT (24H CLIMATIC DATA FOR DAY=,I5/27H DAYS ELAPSED SINCE JAN
1052      2 1=,I5,7H YEAR=,I5,8H MONTH=,I5,6H DAY=,I5)
1053 1630 FORMAT (1X,9A4)
1054 1640 FORMAT (9A4)
1055 1650 FCRMAT (I3,3I10,8F10.2)
1056 1660 FORMAT (I10,F10.0)
1057 1670 FORMAT (24F5.0)
1058 1680 FORMAT (58H SURFACE NO ITYPE IHT IRF ABSP U
1059      2 H,9X,1HA9X,3HWAZ5X,5HSHADE8X,2HUT8X,2HHI)
1060 1690 FORMAT (//21H SHADOW CASTING DATA/121H HT FL FP
1061      2 AW BWL BWR D FP1 A1 B1 C1
1062      3 FP2 A2 B2 C2)
1063 1700 FORMAT (///33H RADIATION INTERCHANGE FACTORS)
1064 1710 FORMAT (108H SURFACE 1 2 3 4
1065      2 5 6 7 8 9 10)
1066 1720 FORMAT (I10,10F10.3)
1067 1730 FORMAT (27H SCLAR DATA (QSUN/QGLASS))
1068 1740 FORMAT (4H /5H )
1069 1750 FORMAT (6H DBA =,F6.2/9H QLDSUM =,F10.0//)
1070 1760 FORMAT (36H TOTAL COOLING CONSUMPTION PER DAY =,F10.0,4H BTU/36H T
1071      20TOTAL HEATING CONSUMPTION PER DAY =,F10.0,4H BTU)
1072 1770 FORMAT (49H TOTAL COOLING CONSUMPTION FOR THE ROOM OVER THE ,I3,14
1073      2H DAY PERIOD =,E11.5,4H BTU/49H TOTAL HEATING CONSUMPTION FOR THE
1074      3 ROOM OVER THE ,I3,13H DAY PERIOD =,E11.5,4H BTU)
1075 1780 FORMAT (31H TOTAL COOLING CONSUMPTION FOR ,I2,8H ROOMS =,E11.5,4H
1076      2BTU/31H TOTAL HEATING CONSUMPTION FOR ,I2,8H ROOMS =,E11.5,4H BTU)
1077 1790 FORMAT (///39H CONGRATULATIONS## NOW YOU ARE ON NESLD)
1078 1800 FCRMAT (/46H WE ASSUME YOU HAVE ALREADY PREPARED THE DATA)
1079 1810 FORMAT (52H ON NBS DATA FORMS..IF YOU HAD NOT ,PLEASE TURN OFF)
1080 1820 FORMAT (57H THE TERMINAL AND HAVE YOUR DATA READY ON THE DATA FOR
1081      2MS)
1082 C
1083 END
1084 @FOR,IS A2
1085 SUBROUTINE ABCD2 (Z,K,L,G,A,B,C,D,NL)
1086 C
1087 C *****
1088 C
1089 DIMENSION AX(10),BX(10),CX(10),DX(10),G(10)
1090 REAL K(10),L(10)
1091 PI=4.*ATAN(1.)
1092 PP=PI*0.5
1093 DO 50 I=1,NL
1094 IF (G(I)) 40,40,10
1095 10 IF (Z) 30,30,20
1096 20 ZG=SQRT(Z/G(I))
1097 ZQL=ZG*L(I)
1098 CC=SIN(ZQL)
1099 C1=COS(ZQL)
1100 S1=CO/ZQL
1101 S2=(S1-C1)/ZGL/ZQL
1102 AX(I)=C1

```

```

1103      BX(I)=L(I)/K(I)*S1
1104      CX(I)=-ZQL*K(I)/L(I)*CO
1105      DX(I)=C1
1106      GO TO 50
1107  30    AX(I)=1.
1108      CX(I)=0.
1109      DX(I)=1.
1110      BX(I)=L(I)/K(I)
1111      GO TO 50
1112  40    AX(I)=1.
1113      BX(I)=1/K(I)
1114      CX(I)=0.
1115      DX(I)=1.
1116  50    CONTINUE
1117      A=AX(1)
1118      B=BX(1)
1119      C=CX(1)
1120      D=DX(1)
1121      IF (NL.LT.2) GO TO 60
1122      CALL MULT (AX,BX,CX,DX,A,B,C,D,NL)
1123  60    RETURN
1124  C
1125      END
1126  @FOR, IS  A3
1127      SUBROUTINE ABCDP2 (Z,K,L,G,AP,BP,CP,DP)
1128  C
1129  C *****
1130  C
1131      REAL K,L
1132      PI=4.*ATAN(1.)
1133      IF (G) 30,30,10
1134  10    PP=PI/4./G
1135      IF (Z) 40,40,20
1136  20    ZG=SQRT(Z/G)
1137      ZQL=ZG*L
1138      X=L*L*0.5/G
1139      RES=L/K
1140      CO=SIN(ZQL)
1141      C1=COS(ZQL)
1142      S1=CO/ZQL
1143      S2=(S1-C1)/ZGL/ZGL
1144      AP=X*S1
1145      BP=X*RES*S2
1146      CP=X*(S1+C1)/RES
1147      DP=X*S1
1148      GO TO 50
1149  C
1150  30    AP=0.
1151      BP=0.
1152      CP=0.
1153      DP=0.
1154      GO TO 50
1155  C
1156  40    CONTINUE
1157      X=L*L*0.5/G
1158      AP=X
1159      BP=X*L/K/3
1160      CP=K/L*X*2.

```



```

1161         DP=X
1162         GC TO 50
1163     C
1164     50     RETURN
1165     C
1166         END
1167     @FCR, IS  A4
1168         SUBROUTINE ADJUST (QL,QLATNT,MONTH,NK,JJ)
1169     C
1170     C     *****
1171     C
1172         IF (MCNTH.GE.6.AND.MCNTH.LE.9) GO TO 30
1173         IF (QL) 10,10,20
1174     10     IF (JJ.GT.1) GO TO 50
1175         IF (NK.LT.8.OR.NK.GT.17) GO TO 50
1176     20     RETURN
1177     C
1178     30     IF (QL) 40,50,50
1179     40     IF (JJ.GT.1) GO TO 50
1180         IF (NK.LT.8.OR.NK.GT.17) GO TO 50
1181         RETURN
1182     C
1183     50     QL=0.
1184         QLATNT=0.
1185         RETURN
1186     C
1187         END
1188     @FOR, IS  A5
1189         SUBROUTINE ATTIC (X,Y,Z,CR,NR,UX,FO,DB,QSUN,QSKY,TOS,TI,TINew,TA,
1190     2 TIM,QRFC,QRFI,QO,QI,UENDW,UCELNG,AENDW,AROOF,ATCHT,ATCACG)
1191     C
1192     C     *****
1193     C
1194     C     THIS ROUTINE CALCULATES HEAT INPUT TO THE ROOM BELOW THE
1195     C     ATTIC CEILING. IT ALSO CALCULATES ATTIC TEMPERATURE
1196     C     X,Y,Z RESPONSE FACTORS FOR ROOF... INSIDE SURFACE THERMAL
1197     C     RESISTANCE IS INCLUDED
1198     C     CR COMMON RATIO OF THE ROOF RESPONSE FACTORS
1199     C NR  NUMBER OF SIGNIFICANT RESPONSE FACTORS TO BE USED
1200     C     UX ROOF OVER ALL HEAT CONDUCTANCE EXCLUDING THE EXTERIOR SURFACE
1201     C     THERMAL RESISTANCE
1202     C     FC ROOF EXTERIOR SURFACE THERMAL TRANSFER COEFFICIENT
1203     C     DB OUTDOOR DRY-BULB TEMPERATURE
1204     C     QSUN SOLAR RADIATION OVER THE ROOF
1205     C     QSKY RADIATION TO THE SKY
1206     C     TCS ROOF SURFACE TEMPERATURE HISTORY
1207     C     TI ATTIC TEMPERATURE HISTORY
1208     C     TONew NEW OUTSIDE SURFACE TEMPERATURE
1209     C     TINew NEW ATTIC TEMPERATURE
1210     C     QRFO HEAT CONDUCTED INTO THE ROOF SURFACE
1211     C     QRFI HEAT CONDUCTED INTO THE ATTIC FROM THE ROOF
1212     C     QO,QI HEAT CONDUCTED INTO THE ROOM BELOW THE ATTIC
1213     C     UENDW OVERALL HEAT TRANSFER COEFFICIENT OF THE END WALL
1214     C     UCELNG OVERALL HEAT TRANSFER COEFFICIENT OF THE CEILING
1215     C     BETWEEN THE ATTIC AIR AND ROOM AIR BELOW
1216     C     AENDW AREA OF THE ATTIC END WALLS
1217     C     ARCOF TOTAL AREA OF THE CEILING
1218     C     ATCHT ATTIC HEIGHT

```



```

1219 C      ATCAGC  ATTIC AIR CHANGE PER HOUR
1220 C      ALL UNITS IN ENGLISH UNIT  ALL LENGTH IN FT
1221      DIMENSION TOS(1),TI(1),X(1),Y(1),Z(1),TOY(50)
1222      CFM=ATCAGC*ATCHT*AROOF/60.
1223      BB=DB-TIM
1224      TAM=TA-TIM
1225      XNUM=QSLN-QSKY+FO*BB
1226      YNUM=UENDW*BB*AENDW+1.08*CFM*BB+UCELNG*TAM*AROOF
1227      YDEN=UENDW*AENDW+UCELNG*AROOF+1.08*CFM
1228      IF (NR.LT.2) GO TO 10
1229      GO TO 20
1230 C
1231 10      TAM=TI(1)
1232      TCNEW=(XNUM+UX*TAM)/(UX+FO)
1233      QRFO=UX*(TAM-TONEW)
1234      QRFI=GRFC
1235      TINEW=(YNUM+UX*ARCOF*TONEW)/(YDEN+UX*AROOF)
1236      TOS(1)=TCNEW
1237      QO=UCELNG*(TAM-TINEW)
1238      QI=QC
1239      TI(1)=TINEW
1240      RETURN
1241 C
1242 20      SUMX=X(1)*TI(1)
1243      SUMZ=0.
1244      SUMY=Y(1)*TI(1)
1245      SUMXY=0.
1246      DO 50 J=2,NR
1247      SUMY=SUMY+Y(J)*TI(J)
1248      SUMX=SUMX+X(J)*TI(J)
1249      SUMXY=SUMXY+Y(J)*TOS(J)
1250 50      SUMZ=SUMZ+Z(J)*TOS(J)
1251      XNUM=XNUM+SUMY-SUMZ+CR*QRFO
1252      TONEW=XNUM/(Z(1)+FO)
1253      TOS(1)=TONEW
1254      SUMZ=SUMZ+Z(1)*TOS(1)
1255      SUMXY=SUMXY+Y(1)*TOS(1)
1256      QRFO=SUMY-SUMZ+CR*QRFO
1257      QRFI=SUMX-SUMXY+CR*QRFI
1258      DO 30 J=2,NR
1259 30      TOY(J)=TI(J-1)
1260      DO 40 J=2,NR
1261 40      TI(J)=TOY(J)
1262      SUMX=0.
1263      SUMY=SUMXY
1264      SUMXY=0.
1265      DO 60 J=2,NR
1266      SUMX=SUMX+X(J)*TI(J)
1267 60      SUMXY=SUMXY+Y(J)*TI(J)
1268      YNUM=YNUM-AROOF*(SUMX-SUMY+CR*QRFI)
1269      YDEN=AROOF*X(1)+YDEN
1270      TINEW=YNUM/YDEN
1271      SUMX=SUMX+TINEW*X(1)
1272      QRFI=SUMX-SUMY+CR*QRFI
1273      SUMXY=SUMXY+Y(1)*TINEW
1274      QRFO=SUMXY-SUMZ+CR*QRFO
1275      QO=UCELNG*(TAM-TINEW)
1276      QI=QO

```

```

1277      TI(1)=TINW
1278      RETURN
1279 C
1280      END
1281 @FOR, IS A6
1282      FUNCTION CCM (SALT, NTYPE, TC)
1283 C
1284 C      *****
1285 C
1286      REAL CC1(10) /.60,.60,.58,.58,.57,.53,.49,.43,.35,.27/
1287      REAL CC2(10) /.88,.88,.88,.87,.85,.83,.79,.73,.61,.46/
1288      REAL CC3(10) /.84,.83,.83,.82,.80,.79,.74,.67,.60,.49/
1289      REAL CC4(10) /1.,1.,1.,1.,.99,.98,.95,.90,.84,.74/
1290      ITC=TC
1291      IF (ITC.NE.0) GO TO 10
1292      CCM=1.
1293      GO TO 60
1294 C
1295 10      CONTINUE
1296      IF (SALT-45.) 40,40,20
1297 20      IF (NTYPE.EQ.0) GO TO 30
1298      CCM=CC2(ITC)
1299      GO TO 60
1300 C
1301 30      CCM=CC4(ITC)
1302      GO TO 60
1303 C
1304 40      IF (NTYPE.EQ.0) GO TO 50
1305      CCM=CC1(ITC)
1306      GO TO 60
1307 C
1308 50      CCM=CC3(ITC)
1309 60      RETURN
1310 C
1311      END
1312 @FOR, IS A7
1313      SUBROUTINE DBRH (DB, RH, W)
1314 C
1315 C      *****
1316 C
1317      PVS=PVSF (DB)
1318      PV=RH*PVS/100.
1319      W=0.622*PV/(29.92-PV)
1320      RETURN
1321 C
1322      END
1323 @FOR, IS A8
1324      SUBROUTINE DECODE (WPOSX, WLONGX, NUM, OUTPUT, MM, YR, MO, DAY, LOCAL)
1325 C
1326 C      *****
1327 C
1328 C      THIS SUBROUTINE PRODUCES HOURLY DATA OF UP TO 10 WEATHER
1329 C      PARAMETERS FOR A GIVEN YEAR, MO AND DATE
1330 C      TAPE FCSTION FOR EACH OF TEN PARAMETERS ARE
1331 C      PARAMETERS          WPOSX          WLONGX
1332 C      WIND SPEED          13              3
1333 C      WIND DIRECTION     11              2
1334 C      DRY-BULB TEMP      16              3

```

```

1335 C      WET-BULB TEMP      19      3
1336 C      DEW-POINT TEMP    22      3
1337 C      BAROMETRIC PRESS  34      4
1338 C      TOTAL CLOUD AMOUNT 43      1
1339 C      OPAQUE CLOUD COVER 44      1
1340 C      PRECIPITATION(LIQUID) 68    2
1341 C      PRECIPITATION(FRZ) 70      3
1342 C      TAPE PCSITICN CN TAPE 280
1343 C      SOLAR DATA        14      4
1344 C      ELEVATION ANGLE    18      2
1345 C      TOTAL CLGUD        42      1
1346 C      1ST LAYER TYPE OF CLOUD 46    1
1347 C      YR          YEAR
1348 C      MO          MONTH
1349 C      DAY         DAY
1350      INTEGER IPS(24), ICHAR(2000), WPOS, WLONG, OUTPUT(24,10), YR, DAY, WORD,
1351      2 WORDX(20), WPOSX(10), WLONGX(10), TAPE1, TAPE2
1352      COMMON TAPE1, TAPE2, NC1, NC2, INPUT(1100)
1353      IASS=1000000
1354      IF (MM.NE.0) GO TO 90
1355      DO 10 I=1,4
1356      CALL WD (0)
1357      DO 10 JJ=1,498
1358      KK=498*(I-1)+JJ
1359      10 ICHAR(KK)=INPUT(JJ)
1360      DO 20 I=1,15
1361      IW=ICHA(I)
1362      CALL WDX (IW)
1363      20 ICHAR(I)=IW
1364      YR=ICHA(10)*10+ICHA(11)+1900
1365      MO=ICHA(12)*10+ICHA(13)
1366      DAY=ICHA(14)*10+ICHA(15)
1367      LOCAL=ICHA(9)
1368      IPWR=1
1369      DO 30 I=1,4
1370      IPWR=IPWR*10
1371      30 LOCAL=LCCAL+ICHA(9-I)*IPWR
1372      DO 80 KU=1,NUM
1373      WPCS=WPOSX(KU)
1374      WLONG=WLCNGX(KU)
1375      DO 40 I=1,6
1376      IPS(I)=15+WPOS+80*(I-1)
1377      DO 40 J=1,3
1378      II=I+J*6
1379      40 IPS(II)=IPS(I)+J*498
1380      DO 70 I=1,24
1381      KI=IPS(I)
1382      KL=KI+WLCNG-1
1383      DO 50 L2=KI,KL
1384      IW=ICHA(L2)
1385      CALL WDX (IW)
1386      50 ICHAR(L2)=IW
1387      LONG=WLCNG-1
1388      IF (ICHA(KI).EQ.IASS.AND.WLONG.GT.1) LONG=WLONG-2
1389      WORD=AES(ICHA(KL))
1390      IF (LCNG.EG.0) GO TO 70
1391      IPWR=1
1392      DO 60 JK=1, LONG

```

```

1393      IPWR=IPWR*10
1394 60    WORD=WORD+ICHAR(KL-JK)*IPWR
1395      IF ( ICHAR(KL).LT.0 ) WORD=-WORD
1396 70    OUTPUT(I,KU)=WORD
1397 80    CONTINUE
1398      GO TO 240
1399      C
1400 90    CALL WD (1)
1401      JZ=0
1402      DO 100 J=1,991,66
1403      JX=J
1404      JZ=JZ+1
1405      IW=INPUT(J)
1406      CALL WDX (IW)
1407      IF (IW.NE.IASS) GO TO 110
1408 100   CONTINUE
1409 110   IF (JX.LT.991) GO TO 130
1410      DO 120 KU=1,NUM
1411      DO 120 J=1,24
1412 120   OUTPUT(J,KU)=IASS
1413      GO TO 240
1414      C
1415 130   JY=JX+20
1416      DO 140 I=JX,JY
1417      IW=INPUT(I)
1418      CALL WDX (IW)
1419 140   ICHAR(I)=IW
1420      YR=ICHAR(JX+5)*10+ICHAR(JX+6)+1900
1421      DAY=ICHAR(JX+9)*10+ICHAR(JX+10)
1422      MO=ICHAR(JX+7)*10+ICHAR(JX+8)
1423      IF (DAY.GT.0) GO TO 150
1424      IY=AES(DAY)
1425      IF (IY.LT.20) DAY=DAY+20
1426      IF (IY.GE.20) DAY=DAY+40
1427 150   CONTINUE
1428      LOCAL=ICHAR(JX+4)
1429      IPWR=1
1430      DO 160 I=1,4
1431      IPWR=IPWR*10
1432      IF ( ICHAR(JX+4-I).GT.0 ) GO TO 160
1433      LOCAL=IASS
1434      GO TO 170
1435 160   LOCAL=LOCAL+ICHAR(JX+4-I)*IPWR
1436 170   CONTINUE
1437      IHR=3+JZ
1438      IF (WPCS.EQ.0) GO TO 240
1439      DO 230 KU=1,NUM
1440      WPCS=WPCSX(KU)
1441      WLONG=WLONGX(KU)
1442      DO 180 I=1,24
1443 180   OUTPUT(I,KU)=0
1444      DO 210 I=1,16
1445      KI=WPOS+66*(I-1)
1446      KL=KI+WLONG-1
1447      DO 190 L2=KI,KL
1448      IW=INPUT(L2)
1449      CALL WDX (IW)
1450 190   ICHAR(L2)=IW

```

```

1451      LCNG=WLCNG-1
1452      IF ( ICHAR(KI).EQ.IASS.AND.WLONG.GT.1) LONG=WLONG-2
1453      WORD=ICHAR(KL)
1454      IF (LCNG.EG.0) GO TO 210
1455      IPWR=1
1456      IPWR=IPWR*10
1457      DO 200 JK=1,LCNG
1458      IF ( ICHAR(KL).LT.0) WORD=-WORD
1459 200    WORD=WORD+ICHAR(KL-JK)*IPWR
1460 210    WORDX(I)=WORD
1461      DO 220 I=1,16
1462      KK=I+3
1463 220    OUTPUT(KK,KU)=WORDX(I)
1464 230    CONTINUE
1465 240    RETLRN
1466 C
1467      END
1468 @FOR, IS  A9
1469      SUBROUTINE DERVT (A,B,C,D,AP,BP,CP,DP,APP,BPP,CPP,DPP,N)
1470 C
1471 C      *****
1472 C
1473      DIMENSION A(N),B(N),C(N),D(N),AP(N),BP(N),CP(N),DP(N),AT(10),
1474 2 BT(10),CT(10),DT(10),ATT(10),BTT(10),CTT(10),DTT(10)
1475      DO 30 I=1,N
1476      DO 20 J=1,N
1477      IF (I.EQ.J) GO TO 10
1478      AT(J)=A(J)
1479      BT(J)=B(J)
1480      CT(J)=C(J)
1481      DT(J)=D(J)
1482      GO TC 20
1483 10    AT(J)=AP(J)
1484      BT(J)=BP(J)
1485      CT(J)=CP(J)
1486      DT(J)=DP(J)
1487 20    CONTINUE
1488 30    CALL MULT (AT,BT,CT,DT,ATT(I),BTT(I),CTT(I),DTT(I),N)
1489      APP=ATT(1)
1490      BFF=BTT(1)
1491      CPP=CTT(1)
1492      DPP=DTT(1)
1493      DO 40 I=2,N
1494      AFF=APP+ATT(I)
1495      BPP=BPP+BTT(I)
1496      CFP=CPP+CTT(I)
1497 40    DPP=DPP+DTT(I)
1498      RETURN
1499 C
1500      END
1501 @FCR, IS  A10
1502      SUBROUTINE DST (YR,MO,CAY,DSTX,DSTY)
1503 C
1504 C      *****
1505 C
1506      INTEGER YR,DAY,DSTX,DSTY
1507      NDAY=WKCAY(YR,MO,DAY)
1508      IF (MO.LT.4.CR.MO.GT.10) GO TO 10

```

```

1509         IF (MO.EQ.4.AND.DAY.LT.24) GO TO 10
1510         IF (NDAY.EQ.1) DSTX=DAY
1511         IF (MO.EQ.10.AND.DAY.LT.24) GO TO 10
1512         IF (NDAY.EQ.1) DSTY=DAY
1513 10      CONTINUE
1514         RETURN
1515 C
1516         END
1517 @FOR, IS  A11
1518         FUNCTION DPF (PV)
1519 C
1520 C      *****
1521 C
1522 C      THIS SUBROUTINE CALCULATES DEW-POINT TEMPERATURE FOR GIVEN VAPOR P
1523         IF (PV) 10,10,20
1524 10      GO TO 40
1525 C
1526 20      CONTINUE
1527         Y=LOG(PV)
1528         IF (PV.GT.0.1836) GO TO 30
1529         DPF=71.98+24.873*Y+0.8927*Y*Y
1530         GO TO 40
1531 C
1532 30      DPF=79.047+30.575*Y+1.8893*Y*Y
1533 40      RETURN
1534 C
1535         END
1536 @FOR, IS  A12
1537         SUBROUTINE ERROR (IDATA,K)
1538 C
1539 C      *****
1540 C
1541         DIMENSION MAX(10) /100,100,150,150,150,3500,10,10,99,999/
1542         DIMENSION MIN(10) /0,0,-40,-40,-40,2000,0,0,0,0/ ,IDATA(24)
1543         DC 10 J=1,24
1544         IZ=IDATA(J)
1545         IF (IZ.GT.MAX(K)) GO TO 10
1546         IF (IZ.LT.MIN(K)) GO TO 10
1547         GO TO 20
1548 10      CCNTINUE
1549 20      IDATA(1)=IZ
1550         DO 40 J=2,24
1551         IZ=IDATA(J)
1552         IF (IZ.GT.MAX(K)) GO TO 30
1553         IF (IZ.LT.MIN(K)) GO TO 30
1554         GO TO 40
1555 30      IDATA(J)=IDATA(J-1)
1556 40      CCNTINUE
1557         RETURN
1558 C
1559         END
1560 @FOR, IS  A13
1561         FUNCTION F (A,B,C)
1562 C
1563 C      *****
1564 C
1565 C      BC = RECEIVING SURFACE
1566 C      AB = SENDING SURFACE

```



```

1567 C      F(A,B,C)= FRCM AB TO BC
1568      PI=3.14159
1569 C      F(C,E,A)=F(A,B,C)*A/C
1570 C      (A*B)*F(A,B,C)=(B*C)*F(C,B,A)
1571      X=A/B
1572      Y=C/B
1573      Z=X*X+Y*Y
1574      A2=LOG((1.+X*X)*(1.+Y*Y)/(1.+Z))
1575      A3=Y*Y*LOG(Y*Y*(1.+Z)/(1.+Y*Y)/Z)
1576      A4=X*X*LOG(X*X*(1.+Z)/(1.+X*X)/Z)
1577      A5=Y*ATAN(1./Y)
1578      A6=X*ATAN(1./X)
1579      A7=SQRT(Z)*ATAN(1./SQRT(Z))
1580      SUM=(A2+A3+A4)/4.+A5+A6-A7
1581      F=SUM/PI/Y
1582      RETURN
1583 C
1584      END
1585 @FCR, IS A14
1586      SUBROUTINE FCTR (L,W,H,SF)
1587 C
1588 C      *****
1589 C
1590      REAL L,SF(6,6)
1591 C      THIS ROUTINE CALCULATES BASIC RADIATION SHAPE FACTORS FOR A ROOM.
1592 C      RADIATION SHAPE FACTOR F(H,L,W)=(H*L)---*(L*W)
1593 C      TO          FROM      C          S          W          N          E
1594 C      C          CEILING    0          FHLW      FHWL      FHLW      FHWL
1595 C      S          SOUTH WALL  FWLH      0          FWHL      RMS        FHWL
1596 C      W          WEST WALL   FLWH      FLHW      0          FLHW      RMW
1597 C      N          NORTH WALL  FWLH      RMN       FWHL      0          FWHL
1598 C      E          EAST WALL   FLWH      FLHW      RME       FLHW      0
1599 C      F          FLOOR      RMF       FHLW      FHWL      FHLW      FHWL
1600 C
1601 C      RM = REMAINDER
1602      FHLW=F(H,L,W)
1603      FHWL=F(H,W,L)
1604      FWLH=F(W,L,H)
1605      FWHL=F(W,H,L)
1606      FLWH=F(L,W,H)
1607      FLHW=F(L,H,W)
1608      RMC=1.-2.*(FHLW+FHWL)
1609      RMS=1.-2.*(FWLH+FWHL)
1610      RMW=1.-2.*(FLWH+FLHW)
1611      RMN=RMS
1612      RME=RMW
1613      RMF=RMC
1614      SF(1,1)=0.
1615      SF(1,2)=FHLW
1616      SF(1,3)=FHWL
1617      SF(1,4)=FHLW
1618      SF(1,5)=FHWL
1619      SF(1,6)=RMC
1620      SF(2,1)=FWLH
1621      SF(2,2)=0.
1622      SF(2,3)=FWHL
1623      SF(2,4)=RMS
1624      SF(2,5)=FHWL

```

```

1625      SF(2,6)=FWLH
1626      SF(3,1)=FLWH
1627      SF(3,2)=FLHW
1628      SF(3,3)=0.
1629      SF(3,4)=FLHW
1630      SF(3,5)=RMW
1631      SF(3,6)=FLWH
1632      SF(4,1)=FWLH
1633      SF(4,2)=RMN
1634      SF(4,3)=FWHL
1635      SF(4,4)=0.
1636      SF(4,5)=FWHL
1637      SF(4,6)=FWLH
1638      SF(5,1)=FLWH
1639      SF(5,2)=FLHW
1640      SF(5,3)=RMF
1641      SF(5,4)=FLHW
1642      SF(5,5)=0.
1643      SF(5,6)=FLWH
1644      SF(6,1)=RMF
1645      SF(6,2)=FHLW
1646      SF(6,3)=FHWL
1647      SF(6,4)=FHLW
1648      SF(6,5)=FHWL
1649      SF(6,6)=0.
1650      RETURN
1651  C
1652      END
1653  @FCR, IS  A15
1654      SUBROUTINE FO (V, IS, FOC, FOT, IWD)
1655  C
1656  C      *****
1657  C
1658  C      THIS SUBROUTINE CALCULATES OUTSIDE SURFACE HEAT TRANSFER
1659  C      COEFFICIENTS, FOT AND FOC
1660  C      FOT....RADIATION PLUS CONVECTION
1661  C      FOC....CONVECTION
1662  C      V.....WIND VELOCITY IN KNOTS
1663  C
1664  C      *****
1665  C
1666  C
1667  C      DIMENSION A(6) /0.,0.001,0.,-0.002,0.,-0.00125/ ,B(6) /.464,0.320,
1668  C      2 0.330,0.315,0.244,0.262/ ,C(6) /2.04,2.20,1.90,1.45,1.80,1.45/
1669  C      VP=V*1.153
1670  C      FOT=A(IS)*VP*VP+B(IS)*VP+C(IS)
1671  C      IWD=1 IF THE SURFACE IS WINDWARD OR PARALLEL TO THE WIND
1672  C      IWD=0 IF THE SURFACE IS LEEWARD
1673  C      IF (IWD.EQ.0) GO TO 20
1674  C      IF (VP-7.0) 20,20,10
1675  C      10 FOC=0.23*VP+1.02
1676  C      GO TO 30
1677  C
1678  C      20 FOC=2.63
1679  C      30 RETURN
1680  C
1681  C      END
1682  @FOR, IS  A16

```

```

1683      SUBROUTINE GLASS (SHDCW,SHDCF,GLTYP,GLAZE,SHGF)
1684      C
1685      C *****
1686      C
1687      DIMENSION TR(9),SH(25)
1688      REAL LAT,LCNG
1689      COMMON /SCL/ LAT,LCNG,TZN,WAZ,WT,CN,DST,LPYR,S(35)
1690      TR(7)=S(19)
1691      TR(8)=GLTYP
1692      TR(9)=GLAZE
1693      CALL TAR (TR)
1694      SH(1)=S(24)
1695      SH(2)=S(22)
1696      SH(3)=S(23)
1697      SH(4)=S(19)
1698      SH(5)=0.5
1699      SH(6)=0.5
1700      SH(7)=0.25
1701      SH(8)=0.
1702      SH(9)=0.7
1703      SH(10)=SHADOW
1704      SH(11)=SHDCF
1705      SH(12)=TR(1)
1706      SH(13)=TR(2)
1707      SH(14)=TR(3)
1708      SH(15)=TR(5)
1709      SH(16)=TR(4)
1710      SH(17)=TR(6)
1711      CALL SHG (SH)
1712      SHGF=SH(18)
1713      RETURN
1714      C
1715      END
1716      @FOR,IS A17
1717      SUBROUTINE GPF (U,ZL,Z)
1718      C
1719      C *****
1720      C
1721      DIMENSION Z(1)
1722      PI=4.*ATAN(1.)
1723      SQTPI=SQRT(PI)
1724      PI2=2./PI
1725      EB=0.001
1726      DB=0.1
1727      WRITE (6,30)
1728      WRITE (6,40)
1729      Z(1)=2*ZL*SQRT(U)/SQTP I
1730      ZZ=Z(1)
1731      Z(2)=Z(1)*(SQRT(2.)-2.)
1732      DO 10 K=3,50
1733      ZK=K
1734      10  Z(K)=Z(1)*(SQRT(ZK)-2.*SQRT(ZK-1)+SQRT(ZK-2.))
1735      DO 20 K=1,50
1736      20  WRITE (6,50) K,Z(K)
1737      RETURN
1738      C
1739      C
1740      30  FORMAT (50H0  RESPONSE FACTORS FOR  SEMI-INFINITE BED

```

```

1741 40  FORMAT (50H0      K      Z(K)
1742 50  FORMAT (1110,3F10.5)
1743 C
1744      END
1745 @FCR, IS  A18
1746      SLBRCUTINE  HOLDAY (YR,MO,DAY,NDAY,HCL)
1747 C
1748 C      *****
1749 C
1750      INTEGER YR,DAY,HOL,WKDAY
1751      NDAY=WKDAY(YR,MO,DAY)
1752      HOL=0
1753      IF (MO.EQ.1.AND.DAY.EQ.1) HOL=1
1754      IF (MO.EQ.12.AND.DAY.EQ.31.AND.NDAY.EQ.6) HOL=1
1755      IF (MO.EQ.1.AND.DAY.EQ.2.AND.NDAY.EQ.2) HOL=1
1756      IF (MO.EQ.2.AND.CAY.EQ.22) HOL=1
1757      IF (MO.EQ.2.AND.DAY.EQ.21.AND.NDAY.EQ.6) HOL=1
1758      IF (MO.EQ.2.AND.CAY.EQ.23.AND.NDAY.EQ.2) HOL=1
1759      IF (MO.EQ.5.AND.CAY.EQ.30) HOL=1
1760      IF (MO.EQ.5.AND.DAY.EQ.29.AND.NDAY.EQ.6) HOL=1
1761      IF (MO.EQ.5.AND.DAY.EQ.31.AND.NDAY.EQ.2) HOL=1
1762      IF (MO.EQ.7.AND.CAY.EQ.4) HOL=1
1763      IF (MO.EQ.7.AND.DAY.EQ.3.AND.NDAY.EQ.6) HOL=1
1764      IF (MO.EQ.7.AND.CAY.EQ.5.AND.NDAY.EQ.2) HOL=1
1765      IF (MO.EQ.12.AND.CAY.EQ.25) HOL=1
1766      IF (MO.EQ.12.AND.DAY.EQ.24.AND.NDAY.EQ.6) HOL=1
1767      IF (MO.EQ.12.AND.CAY.EQ.26.AND.NDAY.EQ.2) HOL=1
1768      IF (MO.EQ.9.AND.CAY.LT.7.AND.NDAY.EQ.2) HOL=1
1769      IF (MO.EQ.11.AND.CAY.GT.24.AND.NDAY.EQ.5) HOL=1
1770      RETURN
1771 C
1772      END
1773 @FOR, IS  A19
1774      SUBRCUTINE  MULT (A,B,C,D,AT,BT,CT,DT,N)
1775 C
1776 C      *****
1777 C
1778      DIMENSION  A(N),B(N),C(N),D(N)
1779      ATT=A(1)
1780      BTT=B(1)
1781      CTT=C(1)
1782      DTT=D(1)
1783      IF (N.LT.2) GO TO 20
1784      DO 10 J=2,N
1785      AT=ATT*A(J)+BTT*C(J)
1786      BT=ATT*B(J)+BTT*D(J)
1787      CT=CTT*A(J)+CTT*C(J)
1788      DT=CTT*B(J)+DTT*D(J)
1789      ATT=AT
1790      BTT=BT
1791      CTT=CT
1792 10  DTT=DT
1793      GO TO 30
1794 C
1795 20  AT=ATT
1796      BT=BTT
1797      CT=CTT
1798      DT=DTT

```

```

1799 30    RETURN
1800 C
1801      END
1802 @FCR, IS  A20
1803      SUBRCUTINE OUTSID (X,Y,Z,CR,UX,FO,DB,TIM,QO,QI,QSUN,QSKY,TO,TI,
1804      2 TCNEW,TA,NR)
1805 C
1806 C      *****
1807 C
1808      DIMENSION TO(1),TI(1),X(1),Y(1),Z(1)
1809      XNUM=QSUN-QSKY+FO*(DB-TIM)
1810      IF (NR.GT.1) GO TO 40
1811      IF (FO) 10,10,20
1812 10    TONEW=TO(1)
1813      GO TO 30
1814 C
1815 20    TAM=TA-TIM
1816      TCNEW=(XNUM+UX*TAM)/(UX+FO)
1817 30    CONTINUE
1818      QO=UX*(TAM-TONEW)
1819      TO(1)=TONEW
1820      GO TO 80
1821 C
1822 40    SUMZ=0.
1823      SUMY=Y(1)*TI(1)
1824      SUMX=X(1)*TI(1)
1825      SUMXY=0.
1826      DO 50 J=2,NR
1827      SUMY=SUMY+Y(J)*TI(J)
1828      SUMX=SUMX+X(J)*TI(J)
1829      SUMXY=SUMXY+Y(J)*TC(J)
1830 50    SUMZ=SUMZ+Z(J)*TO(J)
1831      XNUM=SUMY-SUMZ+CR*QO+XNUM
1832      TONEW=XNUM/(Z(1)+FO)
1833      IF (FO) 60,60,70
1834 60    TONEW=TO(1)
1835 70    TO(1)=TONEW
1836      SUMZ=SUMZ+Z(1)*TO(1)
1837      SUMXY=SUMXY+Y(1)*TO(1)
1838      QO=SUMY-SUMZ+CR*QO
1839 30    CONTINUE
1840      RETURN
1841 C
1842      END
1843 @FCR, IS  A21
1844      SUBRCUTINE PSY1 (CB,WB,PB,DP,PV,W,H,V,RH)
1845 C
1846 C      *****
1847 C
1848      PVP=PVSF(WB)
1849      IF (CB-WB) 30,30,10
1850 10    WSTAR=0.622*PVP/(PB-PVP)
1851      IF (WB-32.) 20,20,40
1852 20    PV=PVP-5.704E-4*PB*(DB-WB)/1.8
1853      GO TO 50
1854 C
1855 30    PV=PVP
1856      GO TO 50

```

```

1857 C
1858 40 CDB=(DB-32.)/1.8
1859 CWB=(WB-32.)/1.8
1860 HL=597.31+0.4409*CDB-CWB
1861 CH=0.2402+0.4409*WSTAR
1862 EX=(WSTAR-CH*(CDB-CWB)/HL)/0.622
1863 PV=PB*EX/(1.+EX)
1864 50 W=0.622*PV/(PB-PV)
1865 V=0.754*(DB+459.7)*(1+7000*W/4360)/PB
1866 H=0.24*DB+(1061+0.444*DB)*W
1867 IF (PV.LE.0) GO TO 70
1868 IF (CB.NE.WB) GO TO 60
1869 DP=DB
1870 RH=1.
1871 GO TO 70
1872 C
1873 60 CONTINUE
1874 DP=DPF(PV)
1875 RH=PV/PVSF(DB)
1876 70 RETURN
1877 C
1878 END
1879 @FOR, IS A22
1880 SUBROUTINE PSY2 (DB,DP,PB,WB,PV,W,H,V,RH)
1881 C
1882 C *****
1883 C
1884 C THIS SUBROUTINE CALCULATES THE FOLLOWINGS WHEN DRY-BULB TEMPERATURE
1885 C (DB),DEW-PCINT TEMPERATURE(DP),AND BAROMETRIC PRESSURE(PB) ARE GIVEN
1886 C WB WET-BULB TEMPERATURE
1887 C W HUMIDITY RATIO
1888 C H ENTHALPY
1889 C V VOLUME
1890 C PV VAPOR PRESSURE
1891 C RH RELATIVE HUMIDITY
1892 IF (DP-DB) 20,10,10
1893 10 DP=DB
1894 20 PV=PVSF(DP)
1895 PV=PVSF(DP)
1896 PVS=PVSF(DB)
1897 RH=PV/PVS
1898 W=0.622*FV/(FB-PV)
1899 V=0.754*(DB+459.7)*(1+7000*W/4360)/PB
1900 H=0.24*DB+(1061+0.444*DB)*W
1901 IF (H) 30,30,40
1902 30 WB=DP
1903 RETURN
1904 C
1905 40 WB=WBFB(H,PB)
1906 RETURN
1907 C
1908 END
1909 @FCR, IS A23
1910 FUNCTION PVSF (X)
1911 C
1912 C *****
1913 C
1914 DIMENSION A(6) /-7.90298,5.02808,-1.3816E-7,11.344,

```



```

1915      2 8.1328E-3,-3.49149/ ,B(4) /-9.09718,-3.56654,0.876793,0.0060273/
1916      3,P(4)
1917      T=(X+459.688)/1.8
1918      IF (T.LT.273.16) GO TO 10
1919      Z=373.16/T
1920      P(1)=A(1)*(Z-1)
1921      P(2)=A(2)*LOG10(Z)
1922      Z1=A(4)*(1-1/Z)
1923      P(3)=A(3)*(10**Z1-1)
1924      Z1=A(6)*(Z-1)
1925      P(4)=A(5)*(10**Z1-1)
1926      GO TO 20
1927      C
1928      10      Z=273.16/T
1929      P(1)=B(1)*(Z-1)
1930      P(2)=B(2)*LOG10(Z)
1931      P(3)=B(3)*(1-1/Z)
1932      P(4)=LOG10(B(4))
1933      20      SUM=0
1934      DO 30 I=1,4
1935      30      SUM=SUM+P(I)
1936      PVSF=29.921*10**SUM
1937      RETURN
1938      C
1939      END
1940      @FCR, IS A24
1941      SUBROUTINE RESF (XX,YY,ZZ,IRUN)
1942      C
1943      C      *****
1944      C
1945      C      THIS PROGRAM IS DEVELOPED BY T.KUSUDA OF THE NATIONAL BUREAU OF
1946      C      STANDARDS FOR CALCULATING THE THERMAL RESPONSE FACTORS FOR
1947      C      COMPOSITE WALLS,FLOORS,ROOFS,BASEMENT WALLS BASEMENT FLOORS
1948      C      REAL K(10),G(10),L(10),KG
1949      C      DIMENSION X(100),Y(100),Z(100),C(10),D(10),RES(10),RMK(10,6)
1950      C      DIMENSION RMKG(6),F(100),XX(100,1),YY(100,1),ZZ(100,1),FF(100,20)
1951      C      DELTAT=1.
1952      C      IRUN=0
1953      C      IN=0
1954      C      WRITE (6,200)
1955      10      READ (5,380) NLAYR
1956      C      IF (NLAYR.EQ.0) GO TO 190
1957      C      IRUN=IRUN+1
1958      C      IF (NLAYR.GT.10) GO TO 190
1959      C      IF (NLAYR.EQ.0) GO TO 30
1960      C      DO 20 I=1,NLAYR
1961      20      READ (5,380) L(I),K(I),D(I),C(I),RES(I)
1962      C      WRITE (6,210)
1963      C      IF (IN.EQ.2) GO TO 40
1964      C      READ K,RHO, AND C OF GROUND IF IN=1
1965      C      FCLLOWINGS ARE GROUND THERMAL CONDUCTIVITY, DENSITY AND SP.HT IF
1966      C      IN=2, OTHERWISE THE SAME PROPERTIES OF THE INTERNAL SLAB
1967      30      IF (IN.NE.0) READ (5,380) KG,DG,CG
1968      C      AG THERMAL DIFFUSIVITY OF EARTH
1969      C      IF (IN.NE.0) AG=KG/CG/DG
1970      C      IF (NLAYR.EQ.0) GO TO 90
1971      C      IF (IN.EG.2) READ (5,320) (RMKG(J),J=1,6)
1972      40      DO 50 I=1,NLAYR

```

```

1973 50 READ (5,320) (RMK(I,J),J=1,6)
1974 IF (IN.EQ.1) READ (5,320) (RMKG(J),J=1,6)
1975 DO 80 I=1,NLAYR
1976 IF (L(I)) 70,60,70
1977 60 G(I)=0.
1978 K(I)=1./RES(I)
1979 GO TO 80
1980 70 G(I)=K(I)/C(I)/D(I)
1981 80 CONTINUE
1982 90 CONTINUE
1983 CALL RESPTK (K,L,C,AG,KG,X,Y,Z,NLAYR,DELTAT,NRT,CR,UT,IN,F)
1984 WRITE (6,230) IRUN
1985 WRITE (6,340)
1986 WRITE (6,240)
1987 WRITE (6,250)
1988 WRITE (6,220)
1989 IF (NLAYR.EQ.0) GO TO 120
1990 IF (IN.EQ.2) WRITE (6,350) KG,DG,CG,(RMKG(J),J=1,4)
1991 DO 110 I=1,NLAYR
1992 IF (L(I)) 110,100,110
1993 100 K(I)=0.
1994 110 WRITE (6,260) I,L(I),K(I),D(I),C(I),RES(I),(RMK(I,J),J=1,6)
1995 IF (IN.EQ.1) WRITE (6,350) KG,DG,CG,(RMKG(J),J=1,6)
1996 120 WRITE (6,280) DELTAT
1997 WRITE (6,270) UT
1998 WRITE (6,290)
1999 WRITE (6,220)
2000 IF (IN.NE.0) GO TO 140
2001 WRITE (6,300)
2002 XX(1,IRUN)=FLOAT(NRT)
2003 YY(1,IRUN)=FLOAT(NRT)
2004 ZZ(1,IRUN)=FLOAT(NRT)
2005 XX(2,IRUN)=CR
2006 YY(2,IRUN)=CR
2007 ZZ(2,IRUN)=CR
2008 XX(NRT+3,IRUN)=UT
2009 DO 130 N=1,NRT
2010 XX(N+2,IRUN)=X(N)
2011 YY(N+2,IRUN)=Y(N)
2012 ZZ(N+2,IRUN)=Z(N)
2013 JN=N-1
2014 130 WRITE (6,310) JN,X(N),Y(N),Z(N)
2015 GC TC 180
2016 C
2017 140 WRITE (6,360)
2018 IF (IN.EQ.1) GC TC 160
2019 IF (IN.EQ.2) GO TO 160
2020 XX(1,IRUN)=FLOAT(NRT)
2021 XX(2,IRUN)=CR
2022 XX(NRT+3,IRUN)=UT
2023 DO 150 N=1,NRT
2024 JN=N-1
2025 X(N)=-X(N)
2026 XX(N+2,IRUN)=X(N)
2027 150 WRITE (6,370) JN,X(N)
2028 GC TC 180
2029 C
2030 160 DO 170 N=1,NRT

```

```

2031      JN=N-1
2032      FF(N+2,IRUN)=F(N)
2033 170    WRITE (6,370) JN,F(N)
2034      FF(1,IRUN)=FLOAT(NRT)
2035      FF(2,IRUN)=CR
2036      FF(NRT+3,IRUN)=UT
2037 180    WRITE (6,220)
2038      WRITE (6,220)
2039      WRITE (6,330) CR
2040      GG TC 10
2041 C
2042 190    RETURN
2043 C
2044 C
2045 200    FORMAT (28H DATA SHEET NO 6 N/L,K,P,C,R)
2046 210    FORMAT (43H DATA SHEET NO 7: DESCRIPTION OF EACH LAYER)
2047 220    FORMAT (2H0 )
2048 230    FORMAT (7H1 IRF=I10)
2049 240    FORMAT (77H0 LAYER      L(I)      K(I)      (I)      C(I)      RES(
2050      2I) DESCRIPTION      )
2051 250    FORMAT (70H NO
2052      2 OF LAYERS)
2053 260    FORMAT (1I6,1F11.3,1F10.3,1F10.2,1F10.3,1F8.2,2X,6A4)
2054 270    FORMAT (58H0
2055      2 U=1F7.3)
2056 280    FORMAT (49H0
2057 290    FORMAT (50H0
2058 300    FORMAT (70H0
2059      2
2060 310    FORMAT (1I17,1F23.4,2F15.4)
2061 320    FORMAT (6A4)
2062 330    FORMAT (44H0
2063 340    FORMAT (50H0 WALL COMPOSITION
2064 350    FORMAT (1F27.3,1F10.2,1F10.3,10X,6A4)
2065 360    FORMAT (50H0
2066 370    FORMAT (1I24,1F21.5)
2067 380    FORMAT ( )
2068 C
2069      END
2070 @FOR, IS A25
2071      SUBROUTINE RESFX (X,Y,Z,XX,YY,ZZ,NR,CR,UT,NEXP)
2072 C
2073 C *****
2074 C
2075      DIMENSION XX(100,10),YY(100,10),ZZ(100,10)
2076      DIMENSION X(10,100),Y(10,100),Z(10,100),NR(10),CR(10),UT(10)
2077      TEST=1.E-6
2078      DO 10 K=1,10
2079      DO 10 J=1,100
2080      XX(J,K)=0
2081      YY(J,K)=0
2082 10      ZZ(J,K)=0
2083      CALL RESF (XX,YY,ZZ,IRUN)
2084      DO 50 K=1,NEXP
2085      I=K
2086      IF(YY(5,K))11,11,12
2087 11      YY(3,K)=0.
2088      YY(4,K)=0.

```

```

2089      YY(5,K)=0.
2090 12    CONTINUE
2091      IF (K.GT.IRUK) GO TO 50
2092      X(I,1)=XX(3,K)
2093      Y(I,1)=YY(3,K)
2094      Z(I,1)=ZZ(3,K)
2095      NR(I)=XX(1,K)
2096      CR(I)=XX(2,K)
2097      JJJ=NR(I)+3
2098      UT(I)=XX(JJJ,K)
2099      NMAX=NR(I)
2100      J1=1
2101      DO 40 J=2,NMAX
2102      J3=J+2
2103      J2=J+1
2104      X(I,J)=XX(J3,K)-XX(J2,K)*CR(I)
2105      Y(I,J)=YY(J3,K)-YY(J2,K)*CR(I)
2106      IF (ABS(X(I,J))-TEST) 20,20,30
2107 20    NR(I)=J
2108      GO TO 50
2109 30    CONTINUE
2110      Z(I,J)=ZZ(J3,K)-ZZ(J2,K)*CR(I)
2111      JK=J
2112 40    CONTINUE
2113 50    CONTINUE
2114      RETURN
2115 C
2116 C
2117      END
2118 @FCR, IS A26
2119      SUBROUTINE RESPTK (K,L,G,AG,KG,X,Y,Z,NL,DT,NR,CR,U,IS,F)
2120 C
2121 C      *****
2122 C
2123      DIMENSION K(10),L(10),G(10),X(100),Y(100),Z(100),AP(10),BP(10),
2124 2 CP(10),DP(10),A(10),B(10),C(10),D(10),ZR1(3),ZR2(3),RB(3),RAP(3),
2125 3 ROOT(100),RA(3,100),ZRK(3,100),RX(100),RY(100),AZ(100),F(100)
2126      REAL K,L,KG
2127      PI=4.*ATAN(1.)
2128      ZN=1.
2129 5      M3=3
2130      IF (IS.NE.1) GO TO 10
2131      ZL=KG/10.
2132      UY=100./AG/DT
2133      CALL GPF (UY,ZL,AZ)
2134      IF (IS.EQ.1.AND.NL.EQ.0) GO TO 360
2135 10    CALL ABCD2 (0.,K,L,G,AX,BX,CX,DX,NL)
2136      RB(1)=DX
2137      RB(2)=1.
2138      RB(3)=AX
2139      U=1./BX
2140      DO 20 I=1,NL
2141      PX=0
2142      CALL ABCDP2 (PX,K(I),L(I),G(I),AP(I),BP(I),CP(I),DP(I))
2143 20    CALL ABCD2 (PX,K(I),L(I),G(I),A(I),B(I),C(I),D(I),1)
2144      IF (NL.LT.2) GO TO 30
2145      CALL DERVT (A,B,C,D,AP,BP,CP,DP,APP,BPP,CPP,DPP,NL)
2146      GO TO 40

```

```

2147 25      ZN=ZN+1.
2148      IF (ZN.GT.4.)GO TO 510
2149      GC TO 5
2150 C
2151 30      APP=AP(1)
2152      BPP=EP(1)
2153      CFF=CP(1)
2154      DPP=CP(1)
2155 4C      RAP(1)=DFP
2156      RAP(2)=0.
2157      RAF(3)=AFP
2158      DO 50 I=1,3
2159      C1=RAP(I)/BX/DT
2160      C2=RB(I)*BFP/BX/BX/DT
2161      ZR2(I)=-C1+C2
2162 50      ZR1(I)=-ZR2(I)+RB(I)/BX
2163 C      ROOTS OF B(P)=0.
2164      NMAX=40
2165      TESTMX=40.
2166      PX=0.001
2167      DPC=0.001/DT
2168      DLX=0.0001
2169      N=0
2170 60      DL=DPD
2171      CALL ABCD2 (PX,K,L,G,AX,BX,CX,DX,NL)
2172 70      PXP=PX+DL
2173      CALL ABCD2 (PXP,K,L,G,AXP,BXP,CXP,DXP,NL)
2174      IF (BX*BXP) 90,110,80
2175 80      PX=PXP
2176      BX=BXP
2177      TESTX=PX*DT
2178      IF (TESTX-TESTMX) 70,170,170
2179 90      IF (DL-DLX) 140,140,100
2180 100     DL=DL/2.
2181      GO TO 70
2182 C
2183 110     IF (BX) 130,120,130
2184 120     RXX=PX
2185      GO TO 150
2186 C
2187 130     RXX=PXP
2188      GO TO 150
2189 C
2190 140     AB=AES(BX/BXP)
2191      RXX=(PX+AB*PXP)/(1.+AB)
2192 150     N=N+1
2193      RCCT(N)=RXX
2194      IF (N.GT.1)DPC=(ROOT(N)-ROOT(N-1))/ZN
2195      NRT=N
2196      PX=RXX+DLX
2197      TESTX=RXX*DT
2198      IF (TESTX-TESTMX) 160,160,170
2199 160     IF (N.LT.NMAX) GO TO 60
2200 170     CONTINUE
2201      IF (ROOT(NRT)-100.) 190,180,180
2202 180     NRT=NRT-1
2203 190     DO 250 JJ=1,NRT
2204      PX=RCCT(JJ)

```

```

2205      DO 200 J=1,NL
2206      CALL ABCD2 (PX,K(J),L(J),G(J),A(J),B(J),C(J),D(J),1)
2207 200    CALL ABCDP2 (PX,K(J),L(J),G(J),AP(J),BP(J),CP(J),DP(J))
2208      CALL ABCC2 (PX,K,L,C,AX,BX,CX,DX,NL)
2209      IF (NL.LT.2) GO TO 210
2210      CALL DERVT (A,B,C,D,AP,BP,CP,DP,APP,BPP,CPP,DPP,NL)
2211      GO TO 220
2212 210    APP=AP(1)
2213      BPP=BP(1)
2214      CPP=CP(1)
2215      DPP=DP(1)
2216 220    PY=BFP*FX*PX*DT
2217      RA(1,JJ)=DX/PY
2218      RA(2,JJ)=1./PY
2219      RA(3,JJ)=AX/PY
2220      PZ=PX*DT
2221      IF (PZ-20.) 240,240,230
2222 230    RX(JJ)=0.
2223      RY(JJ)=25.E16
2224      GO TO 250
2225 240    RX(JJ)=EXP(-PZ)
2226      RY(JJ)=(1.-EXP(PZ))*2
2227 250    CONTINUE
2228      DO 260 JJ=1,NRT
2229      DO 260 M=1,M3
2230      ZR1(M)=RA(M,JJ)*RX(JJ)+ZR1(M)
2231 260    ZR2(M)=RA(M,JJ)*(RX(JJ)*RX(JJ)-2.*RX(JJ))+ZR2(M)
2232      II=1
2233      III=2
2234      IF (ZR1(2).LT.0) ZR1(2)=0.
2235      DO 270 M=1,M3
2236      ZRK(M,1)=ZR1(M)
2237 270    ZRK(M,2)=ZR2(M)
2238      NT=100
2239      DO 310 N=3,NT
2240      NR=N
2241      DO 280 M=1,M3
2242 280    ZRK(M,N)=0.
2243      DO 290 M=1,M3
2244      DO 290 JJ=1,NRT
2245      IF (RX(JJ).LE.0.)GO TO 288
2246      APCWER=ALOG10(RX(JJ))
2247      NDERFL=ABS(APOWER*N)
2248      IF (NDERFL.LE.37)GO TO 285
2249 288    PZ=0.
2250      GO TO 290
2251 285    PZ=(RX(JJ))*N
2252 290    ZRK(M,N)=ZRK(M,N)+PZ*RY(JJ)*RA(M,JJ)
2253      IF (ZRK(1,N-1)*ZRK(1,N-2)) 300,320,300
2254 300    IF (N.LT.5) GO TO 310
2255      TEST1=ZRK(1,N)/ZRK(1,N-1)
2256      TEST2=ZRK(1,N-1)/ZRK(1,N-2)
2257      TEST3=ABS(TEST1-TEST2)
2258      IF (TEST3-0.001) 320,320,310
2259 310    CONTINUE
2260 320    DO 330 N=1,NR
2261      X(N)=ZRK(1,N)
2262      Y(N)=ZRK(2,N)

```



```

2263      IF (Y(N).LT.-1.0E-04)GO TO 25
2264 330    Z(N)=ZRK(3,N)
2265      CR=TEST2
2266      IF (X(3)) 350,340,350
2267 340    CR=0.
2268 350    CONTINUE
2269      IF (IS.EQ.2) GO TO 480
2270      IF (IS.NE.1) GO TO 500
2271 360    IF (NL.EG.0) GO TO 420
2272      GF=2*KG/SQRT(DT*AG*PI)
2273      IF (NR.LT.50) GO TO 380
2274      DO 370 J=50,NR
2275      ZJ=J
2276 370    AZ(J)=GF*(SQRT(ZJ)-2.*SQRT(ZJ-1.))+SQRT(ZJ-2.))
2277      NRR=NPR
2278      GO TO 400
2279 C
2280 380    DO 390 J=NR,50
2281      Z(J+1)=Z(J)*CR
2282      X(J+1)=X(J)*CR
2283 390    Y(J+1)=Y(J)*CR
2284      NRR=50
2285 400    DO 410 J=1,NRR
2286 410    F(J)=X(J)-Y(J)*Y(J)/(Z(J)+AZ(J))
2287      NR=NPR
2288      GO TO 440
2289 C
2290 420    DO 430 J=1,NR
2291 430    F(J)=AZ(J)
2292 440    CONTINUE
2293      CR1=1.
2294      DO 460 J=1,50
2295      CR=F(J+1)/F(J)
2296      TESTCR=ABS(CR-CR1)
2297      IF (TESTCR-0.001) 470,470,450
2298 450    CR1=CR
2299      JJ=J-1
2300 460    CONTINUE
2301 470    NR=J
2302      CR=CR1
2303      GO TO 500
2304 C
2305 480    CONTINUE
2306      DO 490 J=1,NR
2307      F(J)=X(J)+Z(J)-2.*Y(J)
2308      JJ=J-1
2309 490    CONTINUE
2310      RETURN
2311 510    WRITE(6,520)
2312 520    FORMAT(27H ERROR IN SUBROUTINE RESPTK)
2313 C
2314 C
2315      END
2316 @FOR, IS A27
2317      SUBRCUTINE RMRT (HEATG,HLCG,HEATX,HLCX,HEATIS,HLCIS,IW,IL,FC,ISC)
2318 C
2319 C *****
2320 C

```

```

2321 C FC: CCFRECTION FACTOR FOR THE HEAT LOST TO THE SURROUNDINGS
2322 C ISC: SHADING COEFFICIENT INDEX IF ISC=0 EXTERNAL SHADING
2323 C OTHERWISE INTERNAL SHADING
2324 DIMENSION HEATG(2), HLCG(2), HEATX(2), HLCX(2), HEATIS(2), HLCIS(2)
2325 DIMENSION AGO(3), AG1(3), AXO(3), AIS1(4,3), AIS2(4,3), B1(3), AX1(3)
2326 DATA AGO /0.187,0.197,0.224/ , AG1 /-0.097,-0.067,-0.044/
2327 DATA B1 /-0.91,-0.87,-0.82/
2328 DATA AXO /0.676,0.681,0.703/ , AX1 /-0.586,-0.551,-0.523/
2329 DATA (AIS1(1,J),J=1,3) /0.53,0.53,0.53/
2330 DATA (AIS2(1,J),J=1,3) /-0.44,-0.40,-0.35/
2331 DATA (AIS1(2,J),J=1,3) /0.59,0.59,0.59/
2332 DATA (AIS2(2,J),J=1,3) /-0.50,-0.46,-0.41/
2333 DATA (AIS1(3,J),J=1,3) /0.87,0.87,0.87/
2334 DATA (AIS2(3,J),J=1,3) /-0.78,-0.74,-0.69/
2335 DATA (AIS1(4,J),J=1,3) /0.50,0.50,0.50/
2336 DATA (AIS2(4,J),J=1,3) /-0.41,-0.37,-0.32/
2337 HLCG(2)=FC*(AGO(IW)*HEATG(2)+AG1(IW)*HEATG(1))-B1(IW)*HLCG(1)
2338 HLCX(2)=FC*(AXO(IW)*HEATX(2)+AX1(IW)*HEATX(1))-B1(IW)*HLCX(1)
2339 HLCIS(2)=FC*(AIS1(IL,IW)*HEATIS(2)+AIS2(IL,IW)*HEATIS(1))-B1(IW)*H
2340 2LCLIS(1)
2341 IF (ISC.EQ.0) RETURN
2342 HLCG(2)=FC*(AXO(IW)*HEATG(2)+AX1(IW)*HEATG(1))-B1(IW)*HLCG(1)
2343 RETURN
2344 C
2345 END
2346 @FCR, IS A28
2347 SUBROUTINE RMTMK (V,TIF,QL,TA,NEXP,NX,ITK)
2348 C
2349 C *****
2350 C
2351 CCMCN /CC/ X(10,100),Y(10,100),Z(10,100),ITYPE(30),IHT(30),
2352 2 IRF(30),ABSP(30),U(30),H(30),HI(30),A(30),UT(30),TOS(30,48),
2353 3 TIS(30,48),G(30,30),TOY(48),DB(24),QLITX(24,3),QEQUX(24,3),
2354 4 QOCLP(24,3),QOCPS(24),QLITE(24),QEQU(24),QI(30),CR(30),NR(30),
2355 5 QGLAS(30,24),ITHST,UENDW,AZW(30),SHADE(30),RMDBS(24),RMDBW(24),
2356 6 SHD(30),UCELNG
2357 DIMENSION AA(30,30),BB(30),TT(30),TIF(30),A2(30,30),B2(30),B3(30),
2358 2 GSUM(30),V(15)
2359 TS=V(1)
2360 CFML=V(2)
2361 CFMS=V(3)
2362 RRCOM=V(4)
2363 RCELG=V(5)
2364 RRCCML=V(12)
2365 TIM=V(6)
2366 QCMAX=V(7)
2367 QHMAX=V(8)
2368 TUL=V(9)
2369 TLL=V(10)
2370 TSET=V(11)
2371 HR=V(13)
2372 MET=V(14)
2373 DBNX=DB(NX)-TIM
2374 TU=TS-TIM
2375 NEXP2=NEXP+1
2376 DO 10 I=1,NEXP
2377 BB(I)=0.
2378 B2(I)=0.

```

```

2379      DO 10 J=1,NEXP
2380      A2(I,J)=0.
2381 10     AA(I,J)=0.
2382      SHG=0.
2383      HSUM=0.
2384      ASUM=0.
2385      ASUMT=0.
2386      DO 70 I=1,NEXP
2387      NRR=NR(I)
2388      SHG=SHG+QGLAS(I,NX)*A(I)
2389      ASUMT=ASUMT+A(I)
2390      GSUM(I)=0.
2391      DO 20 J=1,NEXP
2392 20     GSUM(I)=GSUM(I)+G(I,J)
2393      IF (ITYPE(I).NE.3) ASUM=ASUM+A(I)
2394      IF (MET.NE.0) GSUM(I)=HR
2395      HSUM=HSUM+HI(I)*A(I)
2396      IR=IRF(I)
2397      CRX=CR(I)
2398      IF(UENDW.NE.0..AND.ITYPE(I).EQ.1)NRR=1
2399      XTEMP=X(IR,1)
2400      YTEMP=Y(IR,1)
2401      ZTEMP=Z(IR,1)
2402      IF (NRR.GE.2) GO TO 30
2403      X(IR,1)=UT(I)
2404      Y(IR,1)=UT(I)
2405      CRX=0.
2406      Z(IR,1)=UT(I)
2407 30     AA(I,I)=X(IR,1)+HI(I)+GSUM(I)
2408      DO 40 J=1,NEXP
2409      IF (I.EQ.J) GC TO 40
2410      AA(I,J)=-G(I,J)
2411 40     CONTINUE
2412      AA(I,NEXP2)=-HI(I)
2413      SUMY=Y(IR,1)*TOS(I,1)
2414      SUMX=0.
2415      IF (NRR.LT.2) GO TO 60
2416      DO 50 J=2,NRR
2417      SUMY=SUMY+Y(IR,J)*TOS(I,J)
2418 50     SUMX=SUMX+X(IR,J)*TIS(I,J)
2419 60     CONTINUE
2420      B3(I)=SUMY-CFX*QI(I)-SUMX
2421      AA(NEXP2,I)=A(I)*HI(I)
2422      X(IR,1)=XTEMP
2423      Y(IR,1)=YTEMP
2424 70     Z(IR,1)=ZTEMP
2425      SHX=SHG/ASUM
2426      QLTEMP=QLITE(NX)*(1-RCELG)*RRDOML+(QDCPS(NX)+QEQU(NX))*RRCOM
2427      QLX=QLTEMP/ASUMT
2428      DO 90 I=1,NEXP
2429      SHF=SHX
2430      QLT=QLX
2431      IF (ITYPE(I).EQ.3.OR.ITYPE(I).EQ.7) SHF=0.
2432      IF (ITYPE(I).EQ.7) QLT=0.
2433 90     BB(I)=B3(I)+SHF+QLT
2434      AA(NEXP2,NEXP2)=-1.08*(CFML+CFMS)-HSUM
2435      JK=1
2436      NEXP3=NEXP2+1

```

```

2437      DC 100 I=1,NEXP2
2438      DO 100 J=1,NEXP2
2439 100    A2(I,J)=AA(I,J)
2440      SUM1=(QOCPS(NX)+QEQUP(NX))*(1.-RROOM)
2441      SUM2=GLITE(NX)*(1.-RRCOML)*(1.-RCELG)
2442      SUM3=0.
2443      SUM=1.08*(CFML*DBNX+CFMS* $TU$ )+SUM1+SUM2
2444      BB(NEXP2)=-SUM
2445      IF (ITHST.NE.0.AND.ITK.EQ.0) GO TO 150
2446 110    BB(NEXP2)=-SUM-SUM3
2447      IF (MET.EQ.0) GO TO 130
2448      SUM4=0.
2449      SUM5=0.
2450      DO 120 I=1,NEXP
2451      SUM4=SUM4+(HI(I)*A(I)*BB(I))/AA(I,I)
2452      SUM5=SUM5+HI(I)*A(I)*(HI(I)+HR)/AA(I,I)
2453 120    CONTINUE
2454      TT(NEXP2)=(SUM4-BB(NEXP2))/(-AA(NEXP2,NEXP2)-SUM5)
2455      DO 121 I=1,NEXP
2456 121    TT(I)=((HI(I)+HR)*TT(NEXP2)+BB(I))/AA(I,I)
2457      GO TO 140
2458      C
2459 130    CONTINUE
2460      CALL SOLVP (NEXP2,NEXP3,AA,BB,TT,30)
2461 140    TA=TT(NEXP2)+TIM
2462      IF (ITHST.EQ.0.AND.ITK.EQ.1) GO TO 190
2463      IF (JK.EQ.2) GO TO 190
2464      GO TO 200
2465      C
2466 150    DC 160 I=1,NEXP2
2467 160    B2(I)=BB(I)-AA(I,NEXP2)*(TA-TIM)
2468      IF (MET.EQ.0) GO TO 180
2469      DO 170 I=1,NEXP
2470      TT(I)=((HI(I)+HR)*(TA-TIM)+BB(I))/AA(I,I)
2471 170    CONTINUE
2472      GO TO 190
2473      C
2474 180    CONTINUE
2475      CALL SOLVP (NEXP,NEXP2,A2,B2,TT,30)
2476 190    CONTINUE
2477      QL=SUM-1.08*(CFML+CFMS)*(TA-TIM)
2478      GO TO 240
2479      C
2480 200    IF (TA-TUL) 210,220,220
2481 210    IF (TA-TLL) 230,230,190
2482 220    TA=TUL
2483      GO TO 150
2484      C
2485 230    TA=TLL
2486      GO TO 150
2487      C
2488 240    SUMG=0.
2489      DC 250 I=1,NEXP
2490      K=IRF(I)
2491      XK1=X(K,1)
2492      TIS(I,1)=TT(I)
2493      TEST=ABS(TT(I))
2494      IF (TEST.GT.100.) GO TO 310

```

```

2495      IF(K.EQ.10)X(K,1)=UT(I)
2496      QI(I)=X(K,1)*TT(I)-B3(I)
2497      IF ( ITYPE(I).EQ.7) QI(I)=0.
2498      IF (UENDW.NE.0..AND.ITYPE(I).EQ.1) QI(1)=UT(1)*(TT(1)-TOS(1,1))
2499      TIF(I)=TT(I)+TIM
2500      IF ( ITYPE(I).EQ.7) TIF(I)=TA
2501      SUMQ=SUMQ+A(I)*HI(I)*(TA-TIF(I))
2502      X(K,1)=XK1
2503 250    CONTINUE
2504      QL=-GL+SUMQ
2505      IF (ITHST.NE.0.OR.ITK.NE.0) GO TO 300
2506      IF (JK.EQ.2) GO TO 300
2507      IF (QL) 260,300,280
2508 260    QLTEST=ABS(QL)
2509      IF (QLTEST-QCMAX) 300,300,270
2510 270    SUM3=-QCMAX
2511      JK=2
2512      GO TO 110
2513  C
2514 280    IF (QL-QHMAX) 300,300,290
2515 290    SUM3=QHMAX
2516      JK=2
2517      GO TO 110
2518  C
2519 300    RETURN
2520  C
2521 310    CONTINUE
2522      WRITE (6,330)
2523      DO 320 I=1,NEXP2
2524 320    WRITE (6,340) (A2(I,J),J=1,NEXP2),B2(I),TT(I)
2525      RETURN
2526  C
2527  C
2528 330    FORMAT (109H ERROR IN THE RMTMK ROUTINE: MATRIX ELEMENTS ARE LISTE
2529 2D IN THE FOLLOWING ORDER:  AA(I,J),J=1,NEXP2,B(I),T(I))
2530 340    FORMAT (12F10.3)
2531  C
2532      END
2533 @FOR, IS A29
2534      SUBROUTINE RCCMX (NEXP,NS,NW,NN,NE,H)
2535  C
2536  C *****
2537  C
2538      DIMENSION NEXP(4)
2539      COMMON /CC/ X(10,100),Y(10,100),Z(10,100),ITYPE(30),IHT(30),
2540 2 IRF(30),ABSP(30),U(30),HT(30),HI(30),A(30),V(30),TOS(30,48),
2541 3 TIS(30,48),G(30,30),TOY(48),DB(24),QLITX(24,3),QEQUX(24,3),
2542 4 QCCUP(24,3),QCCPS(24),QLITE(24),QEQU(24),QI(30),CR(30),NR(30),
2543 5 QGLAS(30,24),ITHST,UENDW,AZW(30),SHADE(30),RMDBS(24),RMDBW(24),
2544 6 SHD(30),UCELNG
2545      REAL L,FS(6,6)
2546      COMMON /SHDW/ SFACW(30,15)
2547  C
2548  C *****
2549  C * * *
2550  C * * *
2551  C * *****
2552  C * * SOUTH FACING *

```



```

2553 C          (W)*   *   WALL   *(H)
2554 C          *   *
2555 C          *****
2556 C          (L)
2557 C
2558 C
2559 C      NS = NUMBER OF HEAT TRANSFER SURFACES IN THE SOUTH WALL
2560 C      NW = NUMBER OF HEAT TRANSFER SURFACES IN THE WEST WALL
2561 C      NN = NUMBER OF HEAT TRANSFER SURFACES IN THE NORTH WALL
2562 C      NE = NUMBER OF HEAT TRANSFER SURFACES IN THE EAST WALL
2563 C      NEXP = TOTAL NUMBER OF HEAT TRANSFER SURFACES = 2+NS+NW+NN+NE
2564 C      WRITE (6,50)
2565 C      READ (5,110) NNEXP
2566 C      NS=NNEXP(1)
2567 C      NW=NNEXP(2)
2568 C      NN=NNEXP(3)
2569 C      NE=NNEXP(4)
2570 C      NEXP=2+NS+NW+NN+NE
2571 C      L = ROOM LENGTH ALONG THE SOUTH WALL
2572 C      W = ROOM WIDTH ALONG THE WEST WALL
2573 C      H = ROOM CEILING HEIGHT
2574 C      READ (5,110) L,W,H
2575 C      CALL FCTR (L,W,H,FS)
2576 C      NS=NS+1
2577 C      NW=NS+NW
2578 C      NN=NW+NN
2579 C      NE=NE+NN
2580 C      AS=L*H
2581 C      AW=W*H
2582 C      AN=AS
2583 C      AE=AW
2584 C      AR=L*W
2585 C      AF=AR
2586 C      WRITE (6,60)
2587 C      DC 10 I=1,NEXP
2588 C      READ FOLLOWING DATA IN THE ORDER OF CEILING, SOUTH WALL, WEST
2589 C      WALL, NORTH WALL, EAST WALL, FLOOR.
2590 C      READ (5,110) ITYPE(I),IRF(I),A(I),AZW(I),U(I),SHADE(I),ABSP(I),SHD
2591 C      2(I)
2592 C      READ SHADOW INFORMATION
2593 C      READ (5,110) (SHADW(I,J),J=1,7)
2594 C      READ (5,110) (SHADW(I,J),J=8,15)
2595 10 CONTINUE
2596 C      DO 20 I=1,NEXP
2597 C      IF (I.EQ.1) M=1
2598 C      IF (I.GT.1.AND.I.LE.NS) M=2
2599 C      IF (I.GT.NS.AND.I.LE.NW) M=3
2600 C      IF (I.GT.NW.AND.I.LE.NN) M=4
2601 C      IF (I.GT.NN.AND.I.LE.NE) M=5
2602 C      IF (I.EQ.NEXP) M=6
2603 C      DO 20 J=1,NEXP
2604 C      IF (J.EQ.1) G(I,J)=FS(M,1)
2605 C      IF (J.GT.1.AND.J.LE.NS) G(I,J)=FS(M,2)*A(J)/AS
2606 C      IF (J.GT.NS.AND.J.LE.NW) G(I,J)=FS(M,3)*A(J)/AW
2607 C      IF (J.GT.NW.AND.J.LE.NN) G(I,J)=FS(M,4)*A(J)/AN
2608 C      IF (J.GT.NN.AND.J.LE.NE) G(I,J)=FS(M,5)*A(J)/AE
2609 C      IF (J.EQ.NEXP) G(I,J)=FS(M,6)
2610 20 CONTINUE

```



```

2611      RETURN
2612 C
2613 C      * * * * *
2614 C
2615      ENTRY RMOUT
2616 C
2617 C      * * * * *
2618 C
2619      WRITE (6,70) NEXP,NNEXP,L,W,H
2620      WRITE (6,80)
2621      DO 30 I=1,6
2622      WRITE (6,100) (FS(I,J),J=1,6)
2623 30     CONTINUE
2624      WRITE (6,90)
2625      DO 40 I=1,NEXP
2626      WRITE (6,100) (G(I,J),J=1,NEXP)
2627 40     CONTINUE
2628      RETURN
2629 C
2630 C
2631 50     FORMAT (36H DATA SHEET NO 10: NS,NW,NN,NE,L,W,H)
2632 60     FORMAT (68H DATA SHEET 11 AND 12: ROOM SURFACE DATA AND EXTERIOR S
2633 2SURFACE SHADOW)
2634 70     FORMAT (///5X24HTHIS ROOM HAS A TOTAL OFI3,23H FEAT TRANSFER SURFA
2635 2CES//15X15HSOUTH WALL HAS I3,9H SURFACES//15X15HWEST WALL HAS I3,
2636 39H SURFACES//15X15HNORTH WALL HAS I3,9H SURFACES//15X15HEAST WALL
2637 4 HAS I3,9H SURFACES//5X30HROOM LENGTH ALONG SOUTH WALL =F7.2//5X30
2638 SHRCOM WIDTH ALONG WEST WALL =F7.2//5X30HROOM CEILING HEIGHT
2639 6      =F7.2//)
2640 80     FORMAT (24H1 BASIC SHAPE FACTORS//)
2641 90     FORMAT (///31H RADIATION EXCHANGE FACTORS//)
2642 100    FORMAT (20F6.3)
2643 110    FORMAT ( )
2644 C
2645      END
2646 @FCR, IS A30
2647      SUBROUTINE SHADOW (SHDX,PHI,COSZ,SHRAT)
2648 C
2649 C      *****
2650 C
2651      DIMENSION SHDX(20)
2652      FL=SHDX(1)
2653      HT=SHDX(2)
2654      FP=SHDX(3)
2655      AW=SHDX(4)
2656      BWL=SHDX(5)
2657      BWR=SHDX(6)
2658      D=SHDX(7)
2659      FP1=SHDX(8)
2660      A1=SHDX(9)
2661      B1=SHDX(10)
2662      C1=SHDX(11)
2663      FP2=SHDX(12)
2664      A2=SHDX(13)
2665      B2=SHDX(14)
2666      C2=SHDX(15)
2667      WAZI=SHDX(16)
2668 C      THIS PROGRAM CALCULATES SHADOW CAST BY OVERHANG AND SIDE FINS

```

```

2669 C THIS PROGRAM HAS BEEN DEVELOPED BY TSENG-YAO SUN
2670 C PHI.....SOLAR AZIMUTH ANGLE
2671 C COSZ...CCSINE OF SOLAR ZENITH ANGLE
2672 C SHRAT..SHADE RATIO:RATIO OF THE SUNLIT AREA TO THE TOTAL WINDOW AR
2673 C HT.....WINDOW HEIGHT
2674 C FL.....WINDOW WIDTH
2675 C FP.....DEPTH OF THE OVERHUNG
2676 C AW.....DISTANCE FROM TOP OF THE WINDOW TO THE OVERHUNG
2677 C BWL....DISTANCE OF THE OVERHUNG EXTENDED BEYOND THE LEFT EDGE OF T
2678 C BWR....DISTANCE OF THE OVERHUNG EXTENDED BEYOND THE RIGHT EDGE OF
2679 C D.....DEPTH OF VERTICAL PROJECTION AT THE END OF THE OVERHUNG
2680 C FP1....DEPTH OF THE LEFT FIN
2681 C A1.....DISTANCE OF THE LEFT FIN EXTENDED ABOVE THE TOP OF THE WIND
2682 C B1.....DISTANCE FROM THE LEFT EDGE OF THE WINDOW TO THE LEFT FIN
2683 C C1.....DISTANCE OF THE LEFT FIN STOP SHORT ABOVE THE BOTTOM OF THE
2684 C FP2....DEPTH OF THE RIGHT FIN
2685 C A2.....DISTANCE OF THE RIGHT FIN EXTENDED ABOVE THE TOP OF THE WIN
2686 C B2.....DISTANCE FROM THE RIGHT EDGE OF THE WINDOW TO THE RIGHT FIN
2687 C C2.....DISTANCE OF THE RIGHT FIN STOP SHORT ABOVE THE BOTTOM OF TH
2688 C WAZI...WINDOW AZIMUTH ANGLE
2689 SHRAT=1.
2690 A=AW
2691 H=HT
2692 GAMMA=PHI-WAZI
2693 COSG=COS(GAMMA)
2694 IF (COSG) 10,10,20
2695 10 SHRAT=0.
2696 GO TO 910
2697 C
2698 20 CONTINUE
2699 SBETA=CCSZ
2700 IF (SBETA) 10,10,30
2701 30 SING=SIN(GAMMA)
2702 VERT=SBETA/SQRT(1.-SBETA*SBETA)/COSG
2703 HCRIZ=ABS(SING)/COSG
2704 TCETA=VERT/HCRIZ
2705 IF (GAMMA) 50,40,40
2706 C -----SUN ON LEFT
2707 40 B=BWL
2708 GO TO 60
2709 C -----SUN ON RIGHT
2710 50 B=BWR
2711 60 ARSHF=0.
2712 AREAV=0.
2713 ARSIF=0.
2714 AREAC=0.
2715 AREA1=0.
2716 ARSH1=0.
2717 FL3=0.
2718 H3=0.
2719 H1=H
2720 FL1=FL
2721 K=1
2722 L=1
2723 T1=FP*VERT
2724 FM1=FP*HCRIZ
2725 IF (FP) 430,430,70
2726 70 T=T1

```

```

2727          FM=FM1
2728          AB=E*TCETA
2729          UG=(FL+B)*TCETA
2730          DE=(H+A)/TCETA
2731 C          -----HCRIZCNTAL OVERFUNG  AREAO
2732          IF (T-A) 330,330,80
2733 80        IF (AB-A) 200,200,90
2734 90        IF (DE-B) 180,180,100
2735 100       IF (FM-B) 170,170,110
2736 110       IF (DE-(FL+B)) 140,140,120
2737 120       IF (FM-(FL+B)) 150,130,130
2738 C          -----HORIZ 9
2739 130       AREAO=FL*(0.5*(AB+UG)-A)
2740          GC TC 430
2741 C
2742 140       IF (T-(H+A)) 150,160,160
2743 C          -----HCRIZ 7
2744 150       AREAO=(T-A)*FL-((FM-B)**2)*TCETA*0.5
2745          L=2
2746          GO TO 270
2747 C          -----HORIZ 8
2748 160       AREAO=H*FL-(DE-B)**2*TCETA*0.5
2749          GO TO 430
2750 C          -----HORIZ 3
2751 170       AREAO=FL*(T-A)
2752          L=2
2753          GO TO 300
2754 C
2755 180       IF (T-(H+A)) 170,190,190
2756 C          -----HORIZ 2
2757 190       AREAO=H*FL
2758          GC TO 900
2759 C
2760 200       IF (UG-A) 330,330,210
2761 210       IF (DE-(FL+B)) 240,240,220
2762 220       IF (FM-(FL+B)) 260,230,230
2763 C          -----HORIZ 6
2764 230       AREAO=(UG-A)**2/TCETA*0.5
2765          GO TO 430
2766 C
2767 240       IF (T-(H+A)) 260,250,250
2768 C          -----HORIZ 5
2769 250       AREAO=H*(FL-(A+0.5*H)/TCETA+B)
2770          GC TC 430
2771 C          -----HORIZ 4
2772 260       AREAO=(T-A)*(FL+B-FM*(1.+A/T)*0.5)
2773          L=2
2774 C          -----VERT PROJ  AREAV
2775 270       FL3=FL+B-FM
2776          IF (T+D-(H+A)) 280,280,290
2777 C          -----VERT 8
2778 280       H3=D
2779          GC TO 420
2780 C          -----VERT 9
2781 290       H3=H+A-T
2782          GO TO 420
2783 C
2784 300       FL3=FL

```

```

2785          IF (T+D-(H+A)) 320,320,310
2786 C        -----VERT 7
2787 310      H3=H+A-T
2788          AREA V=H3*FL3
2789          GO TO 900
2790 C        -----VERT 6
2791 320      H3=D
2792          GO TO 420
2793 C
2794 330      IF (T+D-A) 430,430,340
2795 340      IF (FM-B) 390,390,350
2796 350      IF (FM-(FL+B)) 360,430,430
2797 360      FL3=FL+B-FM
2798          IF (T+D-(H+A)) 380,380,370
2799 C        -----VERT 5
2800 370      H3=H
2801          GO TO 420
2802 C        -----VERT 4
2803 380      H3=T+D-A
2804          GO TO 420
2805 C
2806 390      IF (T+D-(H+A)) 410,400,400
2807 C        -----VERT 2
2808 400      AREA V=H*FL
2809          GO TO 900
2810 C        VERT 3
2811 410      H3=T+D-A
2812          FL3=FL
2813 420      AREA V=FL3*H3
2814 C        -----SIDE FIN AND SHORT SIDE FIN
2815 C        -----SIDE FIN AREA1 ARSIF
2816 430      IF (GAMMA) 450,900,440
2817 440      FPF=FP1
2818          AF=A1
2819          BF=B1
2820          CX=C1
2821          GO TO 460
2822 C
2823 450      FPF=FP2
2824          AF=A2
2825          BF=B2
2826          CX=C2
2827 460      IF (FPF) 900,900,470
2828 470      T=FPF*VERT
2829          FM=FPF*HCRIZ
2830          AF1=AF
2831          IF (AREA0) 530,530,480
2832 C        -----TEST FOR CVERLAP OF FIN AND OVERHUNG SHADOW
2833 480      AT=A+(BF-B)*TCETA
2834          IF (AT-AF) 490,530,530
2835 C        -----OVERLAP EXISTS..L=2 IF OVERHUNG SHADOW HAS HORIZ EDGE IN WIN
2836 490      GO TO (510,500), L
2837 C        -----TEST FOR TYPE OF OVERLAP
2838 500      IF ((FM-BF)-(FM1-B)) 510,520,520
2839 C        -----SET L=1,SHADOW INTERSECT ON INCLINED EDGE OF OVERHUNG SHADOW
2840 C        -----FIN SHADOW IS BELOW INCLINED EDGE OF OVERHUNG SHADOW
2841 510      AF=AT
2842          L=1

```

```

2843      GO TO 530
2844 C      -----L IS 2, HORIZ EDGE OF OVERHUNG SHADOW-PORTION ABOVE HORIZ E
2845 C      -----NOT IN OVERHUNG SHADOW IS FIN SHADOW
2846      AREA1=FL*(T1-A)-AREA0
2847 C      -----RESET TO CALC FIN SHADOW BELOW HORIZ EDGE OF OVHNG SHADOW
2848      AF=T1-A+AF1
2849      H=H+AF1-AF
2850 C      -----SHADOW OF FIN (K=1 ON GLASS K=2 ON VERT PROJ SHADOW)
2851      530      AB=BF*TCETA
2852      UG=(FL+BF)*TCETA
2853      DE=(H+AF)/TCETA
2854      DJ=CX/TCETA
2855      IF (FM-BF) 800,800,540
2856      540      IF (AB-AF) 550,660,660
2857      550      IF (UG-AF) 630,630,560
2858      560      IF (T-AF) 640,640,570
2859      570      IF (UG-(H+AF)) 600,600,580
2860      580      IF (T-(H+AF)) 620,590,590
2861 C      -----FIN 9
2862      590      AREA1=H*((AF+H*0.5)/TCETA-BF)+AREA1
2863      GC TO 730
2864 C
2865      600      IF (FM-(FL+BF)) 620,610,610
2866 C      -----FIN 8
2867      610      AREA1=H*FL-(UG-AF)**2/TCETA*0.5+AREA1
2868      GO TO 730
2869 C      -----FIN 7
2870      620      AREA1=(FM-BF)*H-(T-AF)**2/TCETA*0.5+AREA1
2871      GO TO 770
2872 C
2873      630      IF (FM-(FL+BF)) 640,640,650
2874 C      -----FIN 3
2875      640      AREA1=H*(FM-BF)+AREA1
2876      GO TO 770
2877 C      -----FIN 2
2878      650      AREA1=H*FL+AREA1
2879      GO TO 730
2880 C
2881      660      IF (DE-BF) 800,800,670
2882      670      IF (UG-(H+AF)) 710,710,680
2883      680      IF (T-(H+AF)) 700,690,690
2884 C      -----FIN 6
2885      690      AREA1=(DE-BF)**2*TCETA*0.5+AREA1
2886      GC TO 730
2887 C      -----FIN 4
2888      700      AREA1=(FM-BF)*(H+AF-(T+AB)*0.5)+AREA1
2889      GO TO 770
2890 C
2891      710      IF (FM-(FL+BF)) 700,720,720
2892 C      -----FIN 5
2893      720      AREA1=FL*(H-(BF+FL*0.5)*TCETA+AF)+AREA1
2894 C      -----SHORT SIDE FIN ARSH1, ARSHF
2895      730      IF (DJ-BF) 800,800,740
2896      740      IF (DJ-(FL+BF)) 760,760,750
2897 C      -----SHORT 3
2898      750      ARSH1=-FL*(CX-(BF+FL/2.)*TCETA)
2899      GO TO 800
2900 C      -----SHORT 4

```



```

2901 760 ARSH1=-(CX-AB)**2/TCETA*0.5
2902 GO TO 800
2903 C
2904 770 IF (DJ-EF) 800,800,780
2905 780 IF (DJ-FM) 760,760,790
2906 C -----SHORT 2
2907 790 ARSH1=-(FM-BF)*(CX-(T+AB)*0.5)
2908 800 GO TO (E20,810), K
2909 C
2910 810 ARSH1=-ARSH1
2911 AREA1=-AREA1
2912 820 ARSHF=ARSHF+ARSH1
2913 ARSIF=ARSIF+AREA1
2914 GO TC (E30,900), K
2915 C
2916 830 IF (AREAV) 900,900,840
2917 C -----RESET PARAMETERS TO DEDUCT FIN SHADOW OVERLAP ON VERT PROJ
2918 840 K=2
2919 AREA1=0.
2920 ARSH1=0.
2921 BBF=BF
2922 BF=FM1-B+BF
2923 IF (BF) 850,860,860
2924 850 BF=BBF
2925 860 IF (HT+A-T1-D) 890,890,870
2926 870 CX=CX-(HT+A-T1-D)
2927 IF (CX) 880,890,890
2928 880 CX=0.
2929 890 AF=T1-A+AF
2930 H=H3
2931 FL=FL3
2932 GO TC 530
2933 C ----- SHADED AREA ARSHA
2934 900 ARSHA=AREA0+AREAV+ARSHF+ARSIF
2935 SHRAT=(FL1*H1-ARSHA)/(FL1*H1)
2936 FL=FL1
2937 910 CONTINUE
2938 RETURN
2939 C
2940 END
2941 @FCR, IS A31
2942 SLBROUTINE SHG (SH)
2943 C
2944 C *****
2945 C
2946 DIMENSION SH(20)
2947 C SH(1)=INTENSITY OF DIRECT NCRMAL SOLAR RADIATION
2948 C SH(2)=INTENSITY OF DIFFUSE SKY RADIATION
2949 C SH(3)=INTENSITY CF GROUND REFLECTED DIFFUSE RADIATION
2950 C SH(4)=COSINE OF INCIDENCE OF DIRECT SOLAR RADIATION
2951 C SH(5)=FORM FACTOR BETWEEN THE WINDOW AND THE SKY
2952 C SH(6)=FCRM FACTOR BETWEEN THE WINDOW AND THE GROUND
2953 C SH(7)=THERMAL RESISTANCE AT OUTSIDE SURFACE
2954 C SH(8)=THERMAL RESISTANCE AT THE AIR SPACE (DOUBLE GLAZING)
2955 C SH(9)=THERMAL RESISTANCE AT THE INNER SURFACE
2956 C SH(10)=SUNLIT AREA FACTOR
2957 C SH(11)=SHADING COEFFICIENT ,NON-ZERO VALUE WILL BE GIVEN ONLY
2958 C WHEN THE WINDOW IS SHADED BY DRAPES OR BLINDS OR IF IT HAS

```



```

2959 C          AN INTERPANE SEPARATION OF MORE THAN 1-INCH
2960 C          SH(12)=TRANSMISSION FACTOR FOR DIRECT RADIATION
2961 C          SH(13)=TRANSMISSION FACTOR FOR DIFFUSE RADIATION
2962 C          SH(14)=ABSORPTION FACTOR FOR DIRECT RADIATION (OUTER PANE)
2963 C          SH(15)=ABSORPTION FACTOR FOR DIRECT RADIATION (INNER PANE)
2964 C          SH(16)=ABSORPTION FACTOR FOR DIFFUSE RADIATION(OUTER PANE)
2965 C          SH(17)=ABSORPTION FACTOR FOR DIFFUSE RADIATION(INNER PANE)
2966 C          SH(18)=SCALAR HEAT GAIN
2967 C          COMMON /SOL/ LAT,LCNG,TZN,WAZ,WT,CN,DST,LPYR,S(35)
2968 C          REAL LAT,LONG,NI,NO
2969 C          NI=(SH(7)+SH(8))/(SH(7)+SH(8)+SH(9))
2970 C          NO=(SH(7))/(SH(7)+SH(8)+SH(9))
2971 C          D=S+(10)*SH(1)*SH(4)*(SH(12)+NO*SH(14)+NI*SH(15))
2972 C          DD=(SH(2)*SH(5)+SH(3)*SH(6))*(SH(13)+NO*SH(16)+NI*SH(17))
2973 C          IF (SH(11)) 20,10,20
2974 10          SH(18)=D+DD
2975 C          GO TO 30
2976 C
2977 20          SH(18)=(D+DD)*SH(11)
2978 30          RETURN
2979 C
2980 C          END
2981 @FOR, IS A32
2982 C          SUBROUTINE SOLVP (M,N,C,D,X,I)
2983 C
2984 C          *****
2985 C
2986 C          THIS IS A ROUTINE FOR SOLVING SIMULTANEOUS LINEAR EQUATIONS
2987 C          THE ROUTINE WAS DEVELOPED BY B.A. PEAVY OF NBS
2988 C          ROUTINE FAILS WHEN ANY OF THE DIAGONAL ELEMENTS IS ZERO
2989 C          DIMENSION A(100,101),C(I,1),D(1),X(1)
2990 C          DO 10 IX=1,M
2991 C          DO 10 IY=1,M
2992 10          A(IX,IY)=C(IX,IY)
2993 C          DO 20 IZ=1,M
2994 20          A(IZ,N)=D(IZ)
2995 C          L=1
2996 30          AA=A(L,L)
2997 C          DO 40 K=L,N
2998 40          A(L,K)=A(L,K)/AA
2999 C          DO 60 K=1,M
3000 C          IF (K.EQ.L) GO TO 60
3001 C          AA=-A(K,L)
3002 C          DO 50 IA=L,N
3003 50          A(K,IA)=A(K,IA)+AA*A(L,IA)
3004 60          CONTINUE
3005 C          L=L+1
3006 C          IF (L.LE.M) GO TO 30
3007 C          DO 70 IP=1,M
3008 70          X(IP)=A(IP,N)
3009 C          RETURN
3010 C
3011 C          END
3012 @FOR, IS A33
3013 C          SUBROUTINE SUN
3014 C
3015 C          *****
3016 C

```

```

3017 DIMENSION A0(5) / .302, -.0002, 368.44, .1717, 0.0905 / ,
3018 2 A1(5) / -22.93, .4197, 24.52, -.0344, -.0410 / ,
3019 3 A2(5) / -.229, -3.2265, -1.14, .0032, .0073 / ,
3020 4 A3(5) / -.243, -.0903, -1.09, .0024, .0015 / ,
3021 5 B1(5) / 3.851, -7.351, .58, -.0043, -.0034 / , B2(5) / .002, -9.3912, -.18,
3022 6 0., 0.0004 / , B3(5) / -.055, -.3361, .28, -.0008, -.0006 /
3023 REAL LAT,LATD, LONG, MERID, LOND
3024 COMMON /SQL/ LAT, LONG, TZN, WAZ, WY, CN, DST, LPYR, S(35)
3025 C S(1)= LATITUDE, DEGREES(+NORTH, -SOUTH)
3026 C S(2)= LONGITUDE, DEGREES(+WEST, -EAST)
3027 C S(3)= TIME ZONE NUMBER
3028 C STANDARD TIME DAYLIGHT SAVING TIME
3029 C ATLANTIC 4 3
3030 C EASTERN 5 4
3031 C CENTRAL 6 5
3032 C MOUNTAIN 7 6
3033 C PACIFIC 8 7
3034 C S(4)= DAYS(FROM START OF YEAR)
3035 C S(5)= TIME, HOUR AFTER MIDNIGHT)
3036 C S(6)= DAYLIGHT SAVING TIME INDICATOR
3037 C S(7)= GROUND REFLECTIVITY
3038 C S(8)= CLEARNESS NUMBER
3039 C S(9)= WALL AZIMUTH ANGLE, DEGREES FROM SOUTH
3040 C S(10)= WALL TILT ANGLE, DEGREES FROM HORIZON
3041 C S(11)= SUN RISE TIME (HOURS AFTER MIDNIGHT)
3042 C S(12)= SUN SET TIME
3043 C S(13)= COSZ DIRECTION COSINES
3044 C S(14)= CCSN DIRECTION COSINES
3045 C S(15)= COS(S) DIRECTION COSINES)
3046 C S(16)= ALPHA DIRECTION COSINES NORMAL TO SURFACE
3047 C S(17)= BETA
3048 C S(18)= GAMMA
3049 C S(19)= COS(ETA) COSINE OF INCIDENCE ANGLE
3050 C S(20)= SOLAR ALTITUDE ANGLE
3051 C S(21)= SOLAR AZIMUTH ANGLE
3052 C S(22)= DIFFUSE SKY RADIATION ON HORIZONTAL SURFACE
3053 C S(23)= DIFFUSE GROUND REFLECTED RADIATION
3054 C S(24)= DIRECT NORMAL RADIATION
3055 C S(25)= TOTAL SOLAR RADIATION INTENSITY
3056 C S(26)= DIFFUSE SKY RADIATION INTENSITY
3057 C S(27)= GROUND REFLECTED DIFFUSE RADIATION INTENSITY
3058 C S(28)= SUN DECLINATION ANGLE, DEGREES
3059 C S(29)= EQUATION OF TIME , HOURS
3060 C S(30)= A SOLAR FACTOR
3061 C S(31)= SCLAR FACTOR
3062 C S(32)= SOLAR FACTOR
3063 C S(33)= CLOUD COVER MODIFIER
3064 C S(34) INTENSITY OF DIRECT SOLAR RADIATION ON SURFACE
3065 C S(35) HOUR ANGLE, DEGREE
3066 PI=3.1415927
3067 X=2*PI/366.*S(4)
3068 C1=COS(X)
3069 C2=COS(2*X)
3070 C3=CCS(3*X)
3071 S1=SIN(X)
3072 S2=SIN(2*X)
3073 S3=SIN(3*X)
3074 DO 10 K=1,5

```

```

3075      KS=(K-1)+28
3076  10   S(KS)=A0(K)+A1(K)*C1+A2(K)*C2+A3(K)*C3+B1(K)*S1+B2(K)*S2+B3(K)*S3
3077      S(29)=S(29)/60.
3078      LATD=S(1)
3079      LCNG=S(2)
3080      MERID=15*S(3)
3081      LOND=LONG-MERID
3082      Y=S(28)*PI/180.
3083      YY=LATD*PI/180.
3084      HP=-TAN(Y)*TAN(YY)
3085      TR=12/PI*ACOS(HP)
3086      S(11)=(12-TR)-S(29)+LOND/15.
3087      S(12)=24.-S(11)
3088      H=15*(S(5)-12+S(3)+S(29)-S(6))-S(2)
3089      S(35)=H
3090      S13=SIN(YY)*SIN(Y)+COS(YY)*COS(Y)*COS(H*PI/180.)
3091      S(13)=S13
3092      HP1=180.*ACOS(HP)/PI
3093      X1=ABS(HP1)
3094      X2=ABS(H)
3095      IF (X1-X2) 130,20,20
3096  20   S(14)=COS(Y)*SIN(H*PI/180.)
3097      S(15)=SQRT(1.-S(13)*S(13)-S(14)*S(14))
3098      STEST=S(15)
3099      STEST1=COS(H*PI/180.)-TAN(Y)/TAN(YY)
3100      IF (STEST1) 40,30,30
3101  30   S(15)=STEST
3102      GO TO 50
3103      C
3104  4C   S(15)=-STEST
3105  50   S(20)=ASIN(S(13))
3106      IF (S(15)) 70,60,60
3107  6C   S(21)=ASIN(S(14)/COS(S(20)))
3108      GO TO 80
3109      C
3110  70   S(21)=PI-ASIN(S(14)/COS(S(20)))
3111  80   S(20)=180.*S(20)/PI
3112      S(21)=180.*S(21)/PI
3113      S(24)=S(30)*S(8)*S(33)*EXP(-S(31)/S(13))
3114      S(22)=S(32)*S(24)/S(8)/S(8)
3115      S(23)=S(7)*(S(22)+S(24)*S(13))
3116      WY=S(10)*PI/180.
3117      S(16)=COS(WY)
3118      WA=S(9)*PI/180.
3119      S(16)=COS(WY)
3120      S(17)=SIN(WA)*SIN(WY)
3121      S(18)=COS(WA)*SIN(WY)
3122      S(19)=S(16)*S(13)+S(17)*S(14)+S(18)*S(15)
3123      S(34)=S(24)*S(19)
3124      Y=0.45
3125      IF (S(19)+0.2) 100,100,90
3126  90   Y=0.55+0.437*S(19)+0.313*S(19)**2
3127  100  IF (S(19)) 110,110,120
3128  110  S(19)=0.
3129      S(34)=0.
3130  120  CONTINUE
3131      S(26)=S(22)*Y
3132      S(27)=S(23)*(1-S(16))/2.

```

```

3133      S(25)=S(34)+S(26)+S(27)
3134      GO TO 150
3135      C
3136      130      DO 140 J=14,26
3137      140      S(J)=0.
3138      S(34)=0
3139      150      RETURN
3140      C
3141      END
3142      @FCR, IS  A34
3143      SUBROUTINE TAR (TR)
3144      C
3145      C      ****
3146      C
3147      REAL A1(6) /0.01154,0.77674,-3.94657,8.57881,-8.38135,3.01188/
3148      REAL A2(6) /0.01636,1.40783,-6.79030,14.37378,-13.83357,4.92439/
3149      REAL A3(6) /0.01837,1.92497,-8.89134,18.40197,-17.48648,6.17544/
3150      REAL A4(6) /0.01902,2.35417,-10.4715,21.24322,-19.95978,6.99964/
3151      REAL A5(6) /0.01712,3.50839,-13.8639,26.34330,-23.84846,8.17372/
3152      REAL A6(6) /0.01406,4.15958,-15.0628,27.18492,-23.88518,8.03650/
3153      REAL A7(6) /0.01153,4.55946,-15.4329,26.70568,-22.87993,7.57795/
3154      REAL A8(6) /0.00962,4.81911,-15.4714,25.86516,-21.69106,7.08714/
3155      REAL T1(6) /-0.00885,2.71235,-0.62062,-7.07329,9.75995,-3.89922/
3156      REAL T2(6) /-0.01114,2.39371,0.42978,-8.98262,11.51798,-4.52054/
3157      REAL T3(6) /-0.01200,2.13036,1.13833,-10.07925,12.44161,-4.83285/
3158      REAL T4(6) /-0.01218,1.90950,1.61391,-10.64872,12.83698,-4.95199/
3159      REAL T5(6) /-0.01056,1.29711,2.28615,-10.37132,11.95884,-4.54880/
3160      REAL T6(6) /-0.00835,0.92766,2.15721,-8.71429,9.87152,-3.73328/
3161      REAL T7(6) /-0.00646,0.68256,1.82499,-6.95325,7.80647,-2.94454/
3162      REAL T8(6) /-0.00496,0.51043,1.47607,-5.41985,6.00546,-2.28162/
3163      REAL A01(6) /0.01407,1.06226,-5.59131,12.15034,-11.78092,4.20070/
3164      REAL A02(6) /0.01819,1.86277,-9.24831,19.49443,-18.56094,6.53940/
3165      REAL A03(6) /0.01905,2.47900,-11.7427,24.14037,-22.64299,7.89954/
3166      REAL A04(6) /0.01862,2.96400,-13.4870,27.13020,-25.11877,8.68895/
3167      REAL A05(6) /0.01423,4.14384,-16.66709,31.30484,-27.81955,9.36959/
3168      REAL A06(6) /0.01056,4.71447,-17.33454,30.91781,-26.63898,8.79495/
3169      REAL A07(6) /0.00819,5.01768,-17.21228,29.46388,-24.76915,8.05040/
3170      REAL A08(6) /0.00670,5.18781,-16.84820,27.90292,-22.99619,7.38140/
3171      REAL A11(6) /0.00228,0.34559,-1.19908,2.22336,-2.05287,0.72376/
3172      REAL A12(6) /0.00123,0.29788,-0.92256,1.58171,-1.40040,0.48316/
3173      REAL A13(6) /0.00061,0.26017,-0.72713,1.14950,-0.97138,0.32705/
3174      REAL A14(6) /0.00035,0.22974,-0.58381,0.84626,-0.67666,0.22102/
3175      REAL A15(6) /-0.00009,0.15049,-0.27590,0.25618,-0.12919,0.02859/
3176      REAL A16(6) /-0.00016,0.10579,-0.15035,0.06487,0.02759,-0.02317/
3177      REAL A17(6) /-0.00015,0.07717,-0.09059,0.00050,0.06711,-0.03394/
3178      REAL A18(6) /-0.00012,0.05746,-0.05878,-0.01855,0.06837,-0.03191/
3179      REAL TD1(6) /-0.00401,0.74050,7.20350,-20.11763,19.68824,-6.74585/
3180      REAL TD2(6) /-0.00438,0.57818,7.42065,-20.26848,19.79706,-6.79619/
3181      REAL TD3(6) /-0.00428,0.45797,7.41367,-19.92004,19.40969,-6.66603/
3182      REAL TD4(6) /-0.00401,0.36698,7.27324,-19.29364,18.75408,-6.43968/
3183      REAL TD5(6) /-0.00279,0.16468,6.17715,-15.84811,15.28302,-5.23666/
3184      REAL TD6(6) /-0.00192,0.08180,4.94753,-12.43481,11.92495,-4.07787/
3185      REAL TD7(6) /-0.00136,0.04419,3.87529,-9.59069,9.16022,-3.12776/
3186      REAL TD8(6) /-0.00098,0.02576,3.00400,-4.33834,6.98747,-2.38328/
3187      DIMENSION TR(9),A(8,6),T(8,6),AO(8,6),AI(8,6),TD(8,6)
3188      C      TR(1)= TRANSMISSION FACTOR ,DIRECT
3189      C      TR(2)= TRANSMISSION FACTOR ,DIFFUSE
3190      C      TR(3)= ABSORPTION FACTOR ,DIRECT, OUTER

```



```

3191 C      TR(4)=                      ,DIFFUSE,OUTER
3192 C      TR(5)=                      ,DIRECT ,INNER
3193 C      TR(6)=                      ,DIFFUSE,INNER
3194 C      TR(7)= COSINE OF INCIDENT ANGLE
3195 C      TR(8)=TYPE CF GLASS
3196 C      TR(9)=ID   CODE FOR THE GLAZING
3197 C      ID   =1   SINGLE  GLAZING
3198 C      ID   =2   DOUBLE  GLAZING
3199      DO 10 J=1,6
3200      A(1,J)=A1(J)
3201      A(2,J)=A2(J)
3202      A(3,J)=A3(J)
3203      A(4,J)=A4(J)
3204      A(5,J)=A5(J)
3205      A(6,J)=A6(J)
3206      A(7,J)=A7(J)
3207      A(8,J)=A8(J)
3208      T(1,J)=T1(J)
3209      T(2,J)=T2(J)
3210      T(3,J)=T3(J)
3211      T(4,J)=T4(J)
3212      T(5,J)=T5(J)
3213      T(6,J)=T6(J)
3214      T(7,J)=T7(J)
3215      T(8,J)=T8(J)
3216      AO(1,J)=AO1(J)
3217      AO(2,J)=AO2(J)
3218      AO(3,J)=AO3(J)
3219      AO(4,J)=AO4(J)
3220      AO(5,J)=AO5(J)
3221      AO(6,J)=AO6(J)
3222      AO(7,J)=AO7(J)
3223      AO(8,J)=AO8(J)
3224      AI(1,J)=AI1(J)
3225      AI(2,J)=AI2(J)
3226      AI(3,J)=AI3(J)
3227      AI(4,J)=AI4(J)
3228      AI(5,J)=AI5(J)
3229      AI(6,J)=AI6(J)
3230      AI(7,J)=AI7(J)
3231      AI(8,J)=AI8(J)
3232      TD(1,J)=TD1(J)
3233      TD(2,J)=TD2(J)
3234      TD(3,J)=TD3(J)
3235      TD(4,J)=TD4(J)
3236      TD(5,J)=TD5(J)
3237      TD(6,J)=TD6(J)
3238      TD(7,J)=TD7(J)
3239 10      TD(8,J)=TD8(J)
3240      ETA=TR(7)
3241      L=TR(8)
3242      ID=TR(9)
3243      IF (ID.EQ.2) GO TO 30
3244      TR(1)=T(L,1)
3245      TR(2)=T(L,1)/2.
3246      TR(3)=A(L,1)
3247      TR(4)=A(L,1)/2.
3248      DO 20 J=2,6

```

```

3249      TR(1)=TR(1)+T(L,J)*(ETA**(J-1))
3250      TR(2)=TR(2)+T(L,J)/(J+1)
3251      TR(3)=TR(3)+A(L,J)*(ETA**(J-1))
3252  20    TR(4)=TR(4)+A(L,J)/(J+1)
3253      TR(5)=0
3254      TR(6)=0
3255      GO TO 50
3256  C
3257  30    TR(1)=TD(L,1)
3258      TR(2)=TD(L,1)/2.
3259      TR(3)=AC(L,1)
3260      TR(4)=AO(L,1)/2.
3261      TR(5)=AI(L,1)
3262      TR(6)=AI(L,1)/2.
3263      DC 40 J=2,6
3264      X=ETA**(J-1)
3265      TR(1)=TR(1)+TD(L,J)*X
3266      TR(2)=TR(2)+TD(L,J)/(J+1)
3267      TR(3)=TR(3)+AO(L,J)*X
3268      TR(4)=TR(4)+AO(L,J)/(J+1)
3269      TR(5)=TR(5)+AI(L,J)*X
3270  40    TR(6)=TR(6)+AI(L,J)/(J+1)
3271  50    TR(2)=2*TR(2)
3272      TR(4)=2*TR(4)
3273      TR(6)=2*TR(6)
3274      RETURN
3275  C
3276      END
3277  @FOR,IS A35
3278      SUBROUTINE TEMPSH (MONTH,JJ,NK,RMDBS,RMDBW,RMDBWO,RMDBSO,TA)
3279  C
3280  C      *****
3281  C
3282      DIMENSION RMDBS(24),RMDBW(24)
3283      IF (MONTH.GE.6.AND.MONTH.LE.9) GO TO 20
3284      IF (JJ.GT.1) GO TO 10
3285      TA=RMDBW(NK)
3286      GO TO 40
3287  C
3288  10    TA=RMDBWC
3289      GO TO 40
3290  C
3291  20    IF (JJ.GT.1) GO TO 30
3292      TA=RMDBS(NK)
3293      GO TO 40
3294  C
3295  30    TA=RMDBSO
3296  40    CONTINUE
3297      RETURN
3298  C
3299      END
3300  @FOR,IS A36
3301      FUNCTION WBF (H,PB)
3302  C
3303  C      *****
3304  C
3305  C      THIS PROGRAM APPROXIMATES THE WET-BULB TEMPERATURE WHEN
3306  C      ENTHALPY IS GIVEN

```



```

3307      IF (H) 30,30,10
3308 10    Y=LOG(H)
3309      IF (H.GT.11.758) GC TO 20
3310      WBF=0.6041+3.4841*Y+1.3601*Y*Y+0.97307*Y*Y*Y
3311      GC TC 100
3312 C
3313 20    WBF=30.9185-39.68200*Y+20.5841*Y*Y-1.758*Y*Y*Y
3314      GO TO 100
3315 C
3316 30    WB1=150.
3317      PV1=PVSF(WB1)
3318      W1=0.622*PV1/(PB-PV1)
3319      X1=0.24*WB1+(1061+0.444*WB1)*W1
3320      Y1=H-X1
3321 40    WB2=WB1-1
3322      PV2=PVSF(WB2)
3323      W2=0.622*PV2/(PB-PV2)
3324      X2=0.24*WB2+(1061+0.444*WB2)*W2
3325      Y2=H-X2
3326      IF (Y1*Y2) 90,60,50
3327 50    WB1=WB2
3328      Y1=Y2
3329      GO TO 40
3330 C
3331 60    IF (Y1) 80,70,80
3332 70    WBF=WB1
3333      GO TC 100
3334 C
3335 80    WBF=WB2
3336      GC TC 100
3337 C
3338 90    Z=ABS(Y1/Y2)
3339      WBF=(WB2*Z+WB1)/(1+Z)
3340 100   RETURN
3341 C
3342      END
3343 @FCR, IS A37
3344      COMPILER (FLD=ABS)
3345 C
3346 C
3347 C *****
3348 C
3349      SUBROUTINE WD (MM)
3350 C
3351 C *****
3352 C
3353      INTEGER INCM(176,2),TAPE1,TAPE2
3354      COMMON TAPE1,TAPE2,NC1,NO2,INPUT(1100)
3355      MT=TAPE2
3356      IF (MM.EQ.0) MT=TAPE1
3357      NL=176
3358      IF (MM.EQ.0) NL=83
3359      NM=NO1
3360      NO1=NO2
3361      NO2=NM
3362      IF (NC1.NE.NO2) GC TO 10
3363      NO2=2
3364      CALL NTRAN (MT,24,26)

```

```

3365      CALL NTFAN (MT,2,NL,INCM(1,1),L,22)
3366 10    IF (L.LT.0) GO TO 30
3367      CALL NTRAN (MT,2,NL,INCM(1,N02),L,22)
3368      DO 20 J=1,NL
3369      DO 20 K=1,6
3370      JJ=(K-1)*6
3371      JK=(J-1)*6+K
3372 20    INPUT(JK)=FLC(JJ,6,INCM(J,N01))
3373      GO TO 40
3374      C
3375 30    WRITE (6,50) L
3376      STOP
3377      C
3378 40    CONTINUE
3379      RETURN
3380      C
3381      C
3382 50    FORMAT (20H0 INPUT ERROR L=1I10)
3383      C
3384      END
3385 @FCR,IS A38
3386      SUBROUTINE WDX (IW)
3387      C
3388      C *****
3389      C
3390      DIMENSION IDATA(10) /054,06,07,010,011,012,013,014,015,016/ ,
3391      2 JDATA(10) /C60,C61,062,C63,064,C65,066,067,070,071/ ,
3392      3 KDATA(10) /030,C17,020,021,022,023,024,025,026,027/
3393      DATA KX /041/
3394      DO 10 KK=1,10
3395      IF (IW.EQ.IDATA(KK)) GO TO 20
3396      IF (IW.EQ.JDATA(KK)) GO TO 20
3397      IF (IW.EQ.KDATA(KK)) GO TO 30
3398 10    CONTINUE
3399      IF (IW.EQ.KX) GO TO 40
3400      IW=1CC0000
3401      GO TO 50
3402      C
3403 20    IW=KK-1
3404      GO TO 50
3405      C
3406 30    IW=-(KK-1)
3407      GO TO 50
3408      C
3409 40    IW=10
3410 50    RETURN
3411      C
3412      END
3413 @FCR,IS A39
3414      SUBROUTINE WINTER (A,U,ITYPE,NEXP,CFMWT,DBIN,DBWT,UG,TGW,RHI,RHO,
3415      *UENDW,UCELNG,AENDW,ATCHT,AIRCHG)
3416      C
3417      C *****
3418      C
3419      DIMENSION A(30),U(30),ITYPE(30)
3420      CALL CBRH (DBWT,RHO,W0)
3421      CALL DBRH (DBIN,RHI,WI)
3422      DT=DBIN-CBWT

```

```

3423      DW=WI-WO
3424      QWINTS=1.08*CFMWT*DT
3425      QWINTL=4.5*CFMWT*DW#1060.
3426      DO 20 I=1,NEXP
3427      IF (ITYPE(I).EQ.6.OR.ITYPE(I).EQ.7) GO TO 20
3428      IF(UCELNG.EQ.0..OR.ITYPE(I).NE.1)GO TO 5
3429      X=U(1)*A(1)+1.08*AIRCHG*ATCHT/60.+UENDW*AEENDW
3430      Y=UCELNG*A(1)
3431      TATTIC=(X*DBWT+Y*CBIN)/(X+Y)
3432      QWINTS=QWINTS+Y*(DBIN-TATTIC)
3433      GO TO 20
3434 5      IF (ITYPE(I).NE.5) GO TO 10
3435      QWINTS=QWINTS+UG*A(1)*(DBIN-TGW)
3436      GO TO 20
3437 10     CONTINUE
3438      QWINTS=QWINTS+U(I)*A(I)*DT
3439 20     CONTINUE
3440      TOTAL=QWINTS+QWINTL
3441      WRITE (6,30) QWINTS,QWINTL,TOTAL
3442      RETURN
3443      C
3444      C
3445 30     FORMAT (//30H HEATING LOAD IN BTU PER HOUR /26H          SENSIBLE
3446      2LCAD = F10.0/26H          LATENT   LOAD = F10.0/36H          -----
3447      3-----/26H          TOTAL   LOAD = F10.0///)
3448      C
3449      END
3450  @FOR, IS  A40
3451      FUNCTION WKDAY (YR,MO,DAY)
3452      C
3453      C *****
3454      C
3455      C      WKDAY=1 SUNDAY
3456      C      WKDAY=2 MONDAY
3457      C      WKDAY=3 TUESDAY
3458      C      WKDAY=4 WEDNESDAY
3459      C      WKDAY=5 THURSDAY
3460      C      WKDAY=6 FRIDAY
3461      C      WKDAY=7 SATURDAY
3462      INTEGER YR,DAY,WKDAY,TDAY,FSTDAY
3463      DIMENSION FSTDAY(12) /31,59,90,120,151,181,212,243,273,304,334,
3464      2 365/
3465      N=YR/4
3466      ND=N-485
3467      IY=2
3468      IF (ND.EQ.0) GO TO 40
3469      IF (ND.LT.0) GO TO 10
3470      IADD=2
3471      GO TO 20
3472      C
3473 10     ND=-ND
3474      IADD=-2
3475 20     DO 30 J=1,ND
3476      IY=IY-IADD
3477      IF (IY.GT.7) IY=IY-7
3478      IF (IY.EQ.0) IY=7
3479      IF (IY.LT.0) IY=IY+7
3480 30     CONTINUE

```

```

3481 40 MD=YR-N*4
3482 IF (MD.EQ.0) IWK=IY
3483 IF (MC.EQ.1) IWK=IY+2
3484 IF (MD.EQ.2) IWK=IY+3
3485 IF (MD.EQ.3) IWK=IY+4
3486 IF (IWK.GT.7) IWK=IWK-7
3487 IF (MO.NE.1) GO TO 50
3488 TDAY=DAY-1
3489 GO TO 80
3490 C
3491 50 DO 60 J=2,12
3492 IF (MO.NE.J) GO TO 60
3493 TDAY=FSTDAY(J-1)+DAY-1
3494 GO TO 70
3495 60 CONTINUE
3496 70 IF (MD.EQ.0.AND.MC.GT.2) TDAY=TDAY+1
3497 80 NTX=TDAY/7
3498 NDX=TDAY-7*NTX+IWK
3499 IF (NDX.GT.7) NDX=NDX-7
3500 WKDAY=NDX
3501 KV=YR/100
3502 KTEST=YR-KV*100
3503 IF (MO.GT.2.OR.KTEST.NE.0) GO TO 90
3504 KV=KV-1
3505 90 LV=KV/4
3506 LTEST=KV-LV*4
3507 IF (LTEST.EQ.2) WKDAY=WKDAY+1
3508 IF (LTEST.EQ.1) WKDAY=WKDAY+2
3509 IF (LTEST.EQ.0) WKDAY=WKDAY+3
3510 WKDAY=WKDAY-3*(LV-4)
3511 100 IF (WKDAY.LE.0) WKDAY=WKDAY+7
3512 IF (WKDAY.LE.0) GO TO 100
3513 IF (WKDAY.GT.7) WKDAY=WKDAY-7
3514 RETURN
3515 C
3516 END
3517 @ELT, IL A41
3518 C THIS IS A MAIN PROGRAM FOR DECODING WEATHER BUREAU TAPES.
3519 DIMENSION DB(24),DP(24),WB(24),WS(24),PB(24),TC(24),TOC(24),PR(24)
3520 2,PS(24)
3521 INTEGER WPOS(10) /13,11,16,19,22,34,43,46,68,70/
3522 INTEGER WLON(10) /3,2,3,3,3,4,1,1,2,3/
3523 INTEGER TAPE1,TAPE2,DAY,CITY,YEAR,OUT(24),OUTPUT(24,10)
3524 COMMON TAPE1,TAPE2,NO1,NO2,INPUT(1100)
3525 TAPE1=7
3526 TAPE2=8
3527 READ(5,60) NDYSKP,NDAY
3528 NSKIF=4*NDYSKP
3529 CALL NTRAN(TAPE1,7,NSKIP)
3530 NO1=1
3531 NO2=1
3532 DO 50 N=1,NDAY
3533 CALL DECODE(WPOS,WLON,10,OUTPUT,0,YEAR,MONTH,DAY,CITY)
3534 DO 30 K=1,10
3535 DO 10 J=1,24
3536 10 OUT(J)=OUTPUT(J,K)
3537 CALL ERRCR(OUT,K)
3538 DO 20 J=1,24

```

```

3539 20  OUTPUT(J,K)=OUT(J)
3540 30  CONTINUE
3541      DO 40 J=1,24
3542      WS(J)=OUTPUT(J,1)
3543      DB(J)=OUTPUT(J,3)
3544      WB(J)=OUTPUT(J,4)
3545      DP(J)=OUTPUT(J,5)
3546      PB(J)=OUTPUT(J,6)/100.
3547      TC(J)=OUTPUT(J,7)
3548      PR(J)=OUTPUT(J,9)
3549      PS(J)=OUTPUT(J,10)
3550      TO=2
3551      ITK=OUTPUT(J,8)
3552      IF (ITK.EQ.2) TO=1.
3553      IF (ITK.EQ.8.OR.ITK.EQ.9) TO=0.
3554 40   TOC(J)=TC
3555      WRITE (6,80) YEAR,MONTH,DAY,CITY
3556      IF (N.EQ.1) WRITE (6,70) DB,DP,WB,WS,PB,TC,TOC,PR,PS
3557 50   WRITE (8) DB,DP,WB,WS,PB,TC,TOC,PR,PS,YEAR,MONTH,DAY,CITY
3558      END FILE 8
3559      C
3560      C
3561 60   FORMAT (10I7)
3562 70   FORMAT (12F10.3)
3563 80   FORMAT (22H DATA PROCESSED FOR 4I20)
3564      C
3565      END
3565:

```

NBSLD Sample Input/Output





58 BRICK 13 INCHES  
 59 3  
 60 .25,0.024,3.5,.157,0  
 61 .024,.12,55,.259,0  
 62 0,0,0,0,0.7  
 63 FG WOOL 6-INCHES  
 64 GYPSUM BOARD 1/4-IN  
 65 CEILING SIDE RESISTANCE  
 66 0  
 67 1.,3.,.2,21.,.5.,.5,65.,2000.,1.,1.,.02,1.  
 68 3,3,8,17  
 69 78.,68.,72000.,72000.,65.,50.  
 70 0,0  
 71 2,3,1,2  
 72 35.,93.3,10.7  
 73 1,5,3265.,0.,0.,0.,0.88,0.  
 74 0,0,0,0,0,0,0  
 75 0,0,0,0,0,0,0,0  
 76 2,1,370.,0.,0.,0.,.7,0  
 77 0,0,0,0,0,0,0  
 78 0,0,0,0,0,0,0,0  
 79 3,10,4.5,0.,1.06.,.55,0.,0  
 80 0,0,0,0,0,0,0  
 81 0,0,0,0,0,0,0,0  
 82 2,1,793.,50.,0.,0.,.7,0  
 83 0,0,0,0,0,0,0  
 84 0,0,0,0,0,0,0,0  
 85 3,10,155.,90.,1.06.,.55,0.,0  
 86 0,0,0,0,0,0,0  
 87 0,0,0,0,0,0,0,0  
 88 4,10,50.,50.,.61,0.,.9,0  
 89 0,0,0,0,0,0,0  
 90 0,0,0,0,0,0,0,0  
 91 6,3,374.,180.,0.,0.,0.,0  
 92 0,0,0,0,0,0,0  
 93 0,0,0,0,0,0,0,0  
 94 2,1,918.,-90.,0.,0.,.9,0  
 95 0,0,0,0,0,0,0  
 96 0,0,0,0,0,0,0,0  
 97 3,10,80.,-90.,1.06.,.55,0.,0  
 98 0,0,0,0,0,0,0  
 99 0,0,0,0,0,0,0,0  
 100 8,4,3265.,0.,0.,0.,0.,0  
 101 0,0,0,0,0,0,0  
 102 0,0,0,0,0,0,0,0  
 103 .37,.08,470.,6.5,.02,1.  
 104 0,0,0,4,1  
 105

END PRT

@XQT JIMBAR.NESLD

CCNGRATULATICNS## NOW YOU ARE CN NBSLD

WE ASSUME YOU HAVE ALREADY PREPARED THE DATA  
 CN NBS DATA FORMS..IF YOU HAD NOT ,PLEASE TURN OFF

THE TERMINAL AND HAVE YOUR DATA READY ON THE DATA FORMS

RUNIO,RUNTYP,ASHRAE,IDETAL,METHOD

RUNIO.....IDENTIFICATION OF THE RUN

1 NEED RESPONSE FACTOR DATA

2 SKIP RESPONSE FACTOR DATA

RUNTYP.....TYPE OF RUN

1 ENERGY CALCULATION ..NEEDS WEATHER TAPE

2 DESIGN LOAD CALCULATION

3 DESIGN AND ENERGY LOAD CALCULATIONS

ASHRAE.....0 USE RMTMP

1 USE ASHRAE WEIGHTING FACTORS

IDETAL.....0 NO DETAILED OUTPUT

1 DETAILED OUTPUT

METHCO.....0 REGULAR TREATMENT FOR THE ROOM

.....1 SPECIAL TREATMENT OF THE ROOM

FORT MEYER BLDG 219

LIGHTING SCHEDULE FOR WEEKDAYS

EQUIPMENT USAGE SCHEDULE FOR WEEKDAYS

OCCUPANCY SCHEDULE FOR WEEKDAYS

LIGHTING SCHEDULE FOR WEEKEND

EQUIPMENT SCHEDULE FOR WEEKENDS

OCCUPANCY SCHEDULE FOR WEEKEND

LIGHTING SCHEDULE FOR THE VACATION PERIOD

EQUIPMENT USAGE SCHEDULE FOR THE VACATION PERIOD

OCCUPANCY SCHEDULE FOR THE VACATION PERIOD

THERMOSTAT SETTING FOR THE COOLING SEASON

THERMOSTAT SETTING FOR THE HEATING SEASON

RMDBWO,RMDBSO,RHW,RHS

DATA SHEET NO 1:NDAY,NSKIP,TAPE2

DATA SHEET NO 2 +3 :MCNTH,OAY,ELAPS,DBMAX,RANGE,WBMAX, DBMWT,TGS,TGW,UG,LONG,LAT,TZN,ZLF,RHOW

DATA SHEET NO 4: NAME OF THE ROOM

DATA SHEET NO 5:IROT,ISKIP,INCLUDE

DATA SHEET NO 6 N/L,K,P,C,R

DATA SHEET NO 7: DESCRIPTION OF EACH LAYER

IRF= 1

WALL COMPOSITION

LAYER NO	L(I)	K(I)	(I)	C(I)	RES(I)	DESCRIPTION OF LAYERS
1	.031	.120	55.00	.259	.00	GYPSUM BOARD 3/8-IN
2	.000	.000	.00	.000	.20	AIR SPACE 3/4-IN
3	1.080	.580	125.00	.200	.00	COMMON BRICK 13-IN

TIME INCREMENT DT= 1.

THERMAL CONDUCTANCE U= .431

RESPONSE FACTORS

J	X	Y	Z
0	1.8144	.0000	4.2967
1	-.6456	.0003	-2.5170
2	-.1642	.0047	-.4141
3	-.1045	.0162	-.2144
4	-.0753	.0271	-.1370
5	-.0581	.0331	-.0974
6	-.0467	.0350	-.0739
7	-.0387	.0341	-.0586
8	-.0326	.0319	-.0480
9	-.0279	.0291	-.0402
10	-.0240	.0262	-.0342
11	-.0208	.0233	-.0293
12	-.0181	.0207	-.0254
13	-.0158	.0182	-.0221
14	-.0138	.0160	-.0192
15	-.0121	.0141	-.0168

COMMON RATIO CR= .87392

DATA SHEET NO 7: DESCRIPTION OF EACH LAYER

IRF= 2

WALL COMPOSITION

LAYER NO	L(I)	K(I)	(I)	C(I)	RES(I)	DESCRIPTION OF LAYERS
1	.031	.120	55.00	.259	.00	GYPSUM BOARD 3/8-IN
2	.250	.024	3.50	.157	.00	FG WOOL 6-IN

TIME INCREMENT DT= 1.

THERMAL CONDUCTANCE U= .094

RESPONSE FACTORS

J	X	Y	Z
0	.5709	.0650	.1406
1	-.4771	.0286	-.0469
2	-.0001	.0001	-.0000
3	-.0000	.0000	-.0000
4	-.0000	.0000	-.0000

COMMON RATIO CR= .00157

DATA SHEET NC 7: DESCRIPTION OF EACH LAYER

IRF= 3

WALL COMPOSITION

LAYER NO	L(I)	K(I)	(I)	C(I)	RES(I)	DESCRIPTION OF LAYERS
1	.031	.120	55.00	.259	.00	GYP SUM BOARD 3/8-IN
2	.000	.000	.00	.000	1.00	AIR SPACE 4-IN
3	.031	.120	55.00	.259	.00	GYP SUM BOARD 3/8-IN

TIME INCREMENT DT= 1.

THERMAL CONDUCTANCE U= .658

RESPONSE FACTORS

J	X	Y	Z
0	1.0350	.5905	1.0350
1	-.3771	.0674	-.3771
2	.0000	.0000	.0000
3	.0000	.0000	.0000

COMMON RATIO CR= .00000

DATA SHEET NO 7: DESCRIPTION OF EACH LAYER



IRF= 4

WALL COMPOSITION

LAYER NO	L(I)	K(I)	(I)	C(I)	RES(I)	DESCRIPTION OF LAYERS
1	.010	.122	69.00	.300	.00	ASPHALT TILE 1/8-IN
2	.063	.094	32.00	.200	.00	WOOD FLOOR 3/4-IN
3	.170	.094	32.00	.200	.00	WOOD SUBFLOOR 2-IN

TIME INCREMENT DT= 1.

THERMAL CONDUCTANCE U= .391

RESPONSE FACTORS

J	X	Y	Z
0	1.0303	.1583	.8785
1	-.6150	.2094	-.4640
2	-.0221	.0217	-.0214
3	-.0018	.0018	-.0017
4	-.0001	.0001	-.0001

COMMON RATIO CR= .08120

DATA SHEET NC 7: DESCRIPTION OF EACH LAYER

IRF= 5

WALL COMPOSITION

LAYER NO	L(I)	K(I)	(I)	C(I)	RES(I)	DESCRIPTION OF LAYERS
1	.000	.000	.00	.000	.70	ATTIC SIDE RESISTANCE
2	.073	.094	32.00	.600	.00	WOOD 7/8-IN
3	.000	.000	.00	.000	.08	BUILDING PAPER
4	.050	.750	95.00	.400	.00	GREEN SLATE 1/2-IN

TIME INCREMENT DT= 1.

THERMAL CONDUCTANCE U= .616

RESPONSE FACTORS

J	X	Y	Z
0	.7870	.3149	3.0529
1	-.1623	.2824	-2.3962
2	-.0082	.0177	-.0385
3	-.0004	.0010	-.0021
4	-.0000	.0001	-.0001

COMMON RATIO CR= .05392

DATA SHEET NC 7: DESCRIPTION OF EACH LAYER

IRF= 6

WALL COMPOSITION

LAYER NO	L(I)	K(I)	(I)	C(I)	RES(I)	DESCRIPTION OF LAYERS
1	1.080	.583	125.00	.200	.00	BRICK 13INCHES

TIME INCREMENT DT= 1.

THERMAL CONDUCTANCE U= .540

RESPONSE FACTORS

J	X	Y	Z
0	4.3078	.0000	4.3078
1	-2.5235	.0015	-2.5235
2	-.4152	.0181	-.4152
3	-.2149	.0457	-.2149
4	-.1373	.0609	-.1373
5	-.0974	.0627	-.0974
6	-.0733	.0576	-.0733
7	-.0573	.0501	-.0573
8	-.0457	.0425	-.0457
9	-.0369	.0355	-.0369
10	-.0300	.0294	-.0300
11	-.0245	.0242	-.0245
12	-.0201	.0200	-.0201
13	-.0165	.0164	-.0165
14	-.0135	.0135	-.0135

COMMON RATIO CR= .81966

DATA SHEET NC 7: DESCRIPTION OF EACH LAYER

IRF= 7

WALL COMPOSITION

LAYER NO	L(I)	K(I)	(I)	C(I)	RES(I)	DESCRIPTION OF LAYERS
1	.250	.024	3.50	.157	.00	FG WOOL 6-INCHES
2	.024	.120	55.00	.259	.00	GYP SUM BOARD 1/4-IN
3	.000	.000	.00	.000	.70	CEILING SIDE RESISTANCE

TIME INCREMENT DT= 1.

THERMAL CONDUCTANCE U= .088

RESPONSE FACTORS

J	X	Y	Z
0	.1393	.0438	.4112
1	-.0505	.0423	-.3121
2	-.0005	.0022	-.0104
3	-.0000	.0001	-.0004
4	-.0000	.0000	-.0000

COMMON RATIO CR= .03509

DATA SHEET NO 8: ROOMNO,QLITY, QEQPY, QCU, FLCG, FRAS, TS, CFMV, ARCHGS, ARCHGW, ARCHGM, ZNDRM

DATA SHEET NO 9: IW, IL, TUL, TLL, QC MAX, QH MAX, ITHST, ITK

DATA SHEET NO 10: NS, NW, NN, NE, L, W, H

DATA SHEET 11 AND 12: ROOM SURFACE DATA AND EXTERIOR SURFACE SHADOW

ROOMNO	HT	AG	NOFLR	QCU	ARCHGS	ARCHGW
1.0	10.7	3265.0	1.0	21.0	1.0	1.0

LAT	LONG	TZN	ZNDRM
38.0	76.5	5.0	1.0

QLITY	QEQPX	CFMV	DBIN	TG	TV	RHIN
3.0	.2	2000.0	68.0	44.0	65.0	60.0

NEXP	ITK	ITHST
10	0	0

DATA SHEET NC 13: UENDW,UCELNG,AEND W, ATCHT,AIRCHG,AIRNT  
 DATA SHEET NO 14: IEXTSD, IEXMS, IEXME,NTVNT,NVENT

LENDW	UCELNG	AENDW	ATCHT	U	H	A	WAZ	SHADE	FP2	A2	B2	C2			
4	1	47C.0	ε.S	ABSP	IRF	HT	FP1	D	BWR	BWL	AW	FP	FL	FP	HT
1	1	1	5	.88	.42	6.00	.00	.00	.00	.08	.71	.00	.00	.00	.00
2	2	1	1	.70	.32	6.00	.00	.00	.00	.43	.54	.00	.00	.00	.00
3	3	-1	10	.00	1.06	6.00	.00	.00	.00	10.89	.54	.00	.00	.00	.00
4	2	1	1	.70	.32	6.00	90.00	.00	.00	.43	.54	.00	.00	.00	.00
5	3	-1	10	.00	1.06	6.00	90.00	.00	.00	10.89	.54	.00	.00	.00	.00
6	4	1	10	.90	.61	6.00	180.00	.00	.00	1.27	.54	.00	.00	.00	.00
7	6	1	3	.00	.45	.00	90.00	.00	.00	.66	.54	.00	.00	.00	.00
8	2	1	1	.90	.32	6.00	-90.00	.00	.00	.43	.54	.00	.00	.00	.00
9	3	-1	10	.00	1.06	6.00	-90.00	.55	.00	10.89	.54	.00	.00	.00	.00
10	8	1	4	.00	.25	1.46	3265.00	.00	.00	.39	.54	.00	.00	.00	.00

SHADOW CASTING DATA														
HT	FL	FP	AW	BWL	BWR	D	FP1	A1	B1	C1	FP2	A2	B2	C2
.00	.00	.00	.00	.00	.00	.00	.00	.00	.00	.00	.00	.00	.00	.00
.00	.00	.00	.00	.00	.00	.00	.00	.00	.00	.00	.00	.00	.00	.00
.00	.00	.00	.00	.00	.00	.00	.00	.00	.00	.00	.00	.00	.00	.00
.00	.00	.00	.00	.00	.00	.00	.00	.00	.00	.00	.00	.00	.00	.00
.00	.00	.00	.00	.00	.00	.00	.00	.00	.00	.00	.00	.00	.00	.00
.00	.00	.00	.00	.00	.00	.00	.00	.00	.00	.00	.00	.00	.00	.00
.00	.00	.00	.00	.00	.00	.00	.00	.00	.00	.00	.00	.00	.00	.00
.00	.00	.00	.00	.00	.00	.00	.00	.00	.00	.00	.00	.00	.00	.00
.00	.00	.00	.00	.00	.00	.00	.00	.00	.00	.00	.00	.00	.00	.00
.00	.00	.00	.00	.00	.00	.00	.00	.00	.00	.00	.00	.00	.00	.00

RADIATION INTERCHANGE FACTORS										
SURFACE	1	2	3	4	5	6	7	8	9	10
1	.000	.041	.001	.096	.019	.006	.042	.111	.010	.675
2	.366	.000	.000	.102	.020	.006	.013	.118	.010	.366
3	.366	.000	.000	.102	.020	.006	.013	.118	.010	.366
4	.395	.047	.001	.000	.000	.000	.048	.106	.009	.395
5	.395	.047	.001	.000	.000	.000	.048	.106	.009	.395
6	.395	.047	.001	.000	.000	.000	.048	.106	.009	.395
7	.366	.013	.000	.102	.020	.006	.000	.118	.010	.366
8	.395	.047	.001	.091	.018	.006	.048	.000	.000	.395
9	.395	.047	.001	.091	.018	.006	.048	.000	.000	.395
10	.675	.041	.001	.096	.019	.006	.042	.111	.010	.675

HEATING LOAD IN BTU PER HOUR  
 SENSIBLE LOAD = 125946.  
 LATENT LOAD = 6820.  
 -----  
 TOTAL LOAD = 132766.





13	94.6	73.9	78.0	60.0	-61245.	-7266.
14	96.2	74.3	78.0	60.0	-67573.	-7266.
15	96.8	74.5	78.0	60.0	-71931.	-7266.
16	96.2	74.3	78.4	60.0	-72000.	-6842.
17	94.8	74.0	78.0	60.0	-71305.	-7342.
18	92.6	73.4	85.0	52.5	-24316.	0.
19	90.0	72.7	85.0	52.5	-17841.	0.
20	87.4	72.0	85.0	52.5	-13144.	0.
21	85.2	71.4	85.0	52.5	-9202.	0.
22	83.2	70.8	85.0	52.5	-5660.	0.
23	81.6	70.4	85.0	52.5	-2594.	0.
24	80.4	70.0	85.0	52.5	-28.	0.

DEA = 85.54

GLDSUM = -716519.

TOTAL COOLING CONSUMPTION PER DAY = -716519. BTU  
 TCTAL HEATING CCNSUMPTION PER DAY = 0. BTU  
 TOTAL COOLING CONSUMPTION FOR THE ROOM OVER THE 1 DAY PERIOD = -.71652+06 BTU  
 TCTAL HEATING CCNSUMPTION FOR THE ROOM OVER THE 1 DAY PERIOD = .00000 BTU  
 MAX COCLING LOAD = -78842. MONTH = 8 DAY = 21 HOUR = 16  
 MAX HEATING LOAD = 0. MONTH = 0 DAY = 0 HOUR = 0  
 TCTAL COCLING CCNSUMPTION FOR 1 ROOMS = -.71652+06 BTU  
 TOTAL HEATING CONSUMPTION FOR 1 ROOMS = .00000 BTU  
 DATA SHEET NO 4: NAME OF THE ROOM

@PRT,S QAZ\*MYFILE.MEYER1

FURFUR NS26H-03/05-12:01

GAZ\*MYFILE(1).MEYER1(1)

1 2,1,C,0,0  
2 FORT MEYER BLDG 219  
3 0.,0.,0.,0.,0.,0.,0.,1.,1.,1.,1.,1.,1.,1.,1.,1.,1.,0.,0.,0.,0.,0.,0.,0.  
4 0.,0.,0.,0.,0.,0.,0.,1.,1.,1.,1.,1.,1.,1.,1.,1.,1.,0.,0.,0.,0.,0.,0.,0.  
5 0.,0.,0.,0.,0.,0.,0.,1.,1.,1.,1.,1.,1.,1.,1.,1.,1.,0.,0.,0.,0.,0.,0.,0.  
6 0,0,0,0,0,0,0,2,2,2,2,2,2,2,2,2,2,0,0,0,0,0,0,0  
7 0,0  
8 0,0,0,0,0,0,0,0,05,05,05,05,05,05,05,05,05,05,0,0,0,0,0,0,0  
9 0,0  
10 0,0  
11 0,0  
12 85.,85.,85.,85.,85.,85.,85.,78.,78.,78.,78.,78.,78.,78.,78.,78.,85.,85.,85.  
13 85.,85.,85.,85.  
14 60.,60.,60.,60.,60.,60.,60.,60.,68.,68.,68.,68.,68.,68.,68.,68.,68.,68.,60.,60.,60.  
15 60.,60.,60.,60.  
16 60.,85.,20.,60.  
17 31,0,0  
18 8.,21.,232.,56.8,20.,74.9,20.,66.,44.,0.1,76.5,38.,5.,256.,20.  
19 CFFICE  
20 0,0,0  
21 1.,3.,.2,21.,.5.,5,65.,2000.,1.,1.,.02,1.  
22 3,3,8,17  
23 78.,68.,72000.,72000.,65.,50.  
24 0,0  
25 2,3,1,2  
26 35.,93.3,10.7  
27 1,5,3265.,0.,0.,0.,0.88,0.  
28 0,0,0,0,0,0,0  
29 0,0,0,0,0,0,0,0  
30 2,1,370.,0.,0.,0.,.7,0  
31 0,0,0,0,0,0,0  
32 0,0,0,0,0,0,0,0  
33 3,10,4.5,0.,1.06.,.55,0.,0  
34 0,0,0,0,0,0,0  
35 0,0,0,0,0,0,0,0  
36 2,1,793.,90.,0.,0.,.7,0  
37 0,0,0,0,0,0,0  
38 0,0,0,0,0,0,0,0  
39 3,10,155.,90.,1.06.,.55,0.,0  
40 0,0,0,0,0,0,0  
41 0,0,0,0,0,0,0,0  
42 4,10,50.,90.,.61,0.,.9,0  
43 0,0,0,0,0,0,0,0  
44 0,0,0,0,0,0,0,0  
45 6,3,374.,180.,0.,0.,0.,0  
46 0,0,0,0,0,0,0,0  
47 0,0,0,0,0,0,0,0  
48 2,1,918.,-90.,0.,0.,.9,0  
49 0,0,0,0,0,0,0,0  
50 0,0,0,0,0,0,0,0  
51 3,10,80.,-90.,1.06.,.55,0.,0  
52 0,0,0,0,0,0,0,0  
53 0,0,0,0,0,0,0,0  
54 8,4,3265.,0.,0.,0.,0.,0  
55 0,0,0,0,0,0,0,0  
56 0,0,0,0,0,0,0,0  
57 .37.,.08,470.,6.5.,.02,1.

58 0,0,0,4,1  
59  
END PRT

@XGT JIMBAR.NESLD

CCNGRATULATIONS## NOW YOU ARE ON NBSLD

WE ASSUME YOU HAVE ALREADY PREPARED THE DATA  
ON NBS DATA FORMS..IF YOU HAD NOT ,PLEASE TURN OFF  
THE TERMINAL AND HAVE YOUR DATA READY ON THE DATA FORMS

RUNID,RUNTYP,ASHRAE,IDETAL,METHCD

RUNID.....IDENTIFICATION OF THE RUN  
1 NEED RESPONSE FACTOR DATA  
2 SKIP RESPONSE FACTOR DATA  
RLNTYP.....TYPE OF RUN  
1 ENERGY CALCULATION ..NEEDS WEATHER TAPE  
2 DESIGN LOAD CALCULATION  
3 DESIGN AND ENERGY LOAD CALCULATIONS  
ASHRAE.....0 USE RMTMP  
1 USE ASHRAE WEIGHTING FACTORS  
IDETAL.....0 NO DETAILED OUTPUT  
1 DETAILED OUTPUT  
METHCD.....0 REGULAR TREATMENT FOR THE ROOM  
.....1 SPECIAL TREATMENT OF THE ROOM

FORT MEYER BLDG 219  
LIGHTING SCHEDULE FOR WEEKDAYS  
EQUIPMENT USAGE SCHEDULE FOR WEEKDAYS  
OCCUPANCY SCHEDULE FOR WEEKDAYS  
LIGHTING SCHEDULE FOR WEEKEND  
EQUIPMENT SCHEDULE FOR WEEKENDS  
OCCUPANCY SCHEDULE FOR WEEKEND  
LIGHTING SCHEDULE FOR THE VACATION PERIOD  
EQUIPMENT USAGE SCHEDULE FOR THE VACATION PERIOD  
OCCUPANCY SCHEDULE FOR THE VACATION PERIOD  
THERMCSTAT SETTING FOR THE COOLING SEASON  
THERMOSTAT SETTING FOR THE HEATING SEASON  
RMCEWO,RMDBSO,RMW,RHS  
DATA SHEET NO 1: NDAY, NSKIP, TAPE2  
DATA SHEET NO 2 +3 : MONTH, DAY, ELAPS, DBMAX, RANGE, WBMAX, DBMWT, TGS, TGW, UG, LONG, LAT, TZN, ZLF, RHOW  
DATA SHEET NO 4: NAME OF THE ROOM  
DATA SHEET NO 5: IROT, ISKIP, INCLUDE  
DATA SHEET NO 8: ROOMNC, QLITY, QEQPY, QCU, FLCG, FRAS, TS, CFMV, ARCHGS, ARCHGW, ARCHGM, ZNORM  
DATA SHEET NO 9: IW, IL, TUL, TLL, QC MAX, QHMAX, ITHST, ITK  
DATA SHEET NO 10: NS, NW, NN, NE, L, W, H  
DATA SHEET 11 AND 12: ROOM SURFACE DATA AND EXTERIOR SURFACE SHADOW

ROOM NAME= OFFICE				MCNTH=		
DAY	MHR	QLMAX	CLDAY	HLDAY	DBA	
1	1	24	67266.	0.	833917.	33.4
1	2	8	74977.	0.	1557859.	24.0
1	3	8	69210.	0.	1339045.	28.8
1	4	8	51673.	0.	767721.	41.8
1	5	24	46525.	0.	829164.	36.1
1	6	6	54181.	0.	1099831.	31.3
1	7	8	49389.	0.	982197.	35.5
1	8	4	43912.	0.	923993.	35.5
1	9	4	44824.	0.	851840.	36.7
1	10	24	49385.	0.	871738.	37.6
1	11	9	64347.	0.	1239178.	28.5
1	12	4	54753.	0.	1079643.	32.6
1	13	24	46914.	0.	855627.	37.5
1	14	24	71760.	0.	1394308.	24.4
1	15	17	72942.	0.	1742967.	17.4
1	16	7	72919.	0.	1588378.	22.8
1	17	15	74586.	0.	1768679.	13.8
1	18	11	73847.	0.	1680665.	18.2
1	19	4	74156.	0.	1430075.	25.0
1	20	5	63771.	0.	1141373.	32.5
1	21	8	46194.	0.	765276.	40.3
1	22	5	31852.	0.	436868.	48.6
1	23	24	48898.	0.	335641.	49.1
1	24	8	68003.	0.	1301764.	25.4
1	25	6	56741.	0.	1157575.	30.0
1	26	6	48566.	0.	826622.	38.5
1	27	1	37008.	0.	707440.	40.8
1	28	8	40155.	0.	797525.	37.2
1	29	8	43283.	0.	789407.	38.5
1	30	8	42105.	0.	789377.	38.0
1	31	8	43971.	0.	875430.	35.2

MCNTHLY COOLING LOAD= .00000000 BTU

MCNTHLY HEATING LCAD= .32761124+08 BTU

MAX COOLING LOAD = 0. MCNTH = 0 DAY = 0 HOUR = 0  
 MAX HEATING LOAD = 74977. MCNTH = 1 DAY = 2 HOUR = 8  
 TCTAL COOLING CONSUMPTION FOR 1 ROOMS = .00000 BTU  
 TCTAL HEATING CONSUMPTION FOR 1 ROOMS = .32761+08 BTU  
 DATA SHEET NO 4: NAME OF THE ROOM

@BRKPT PRINT\$



# 11. ASHRAE PSYCHROMETRIC CHART NO. 1

NORMAL TEMPERATURE  
 BAROMETRIC PRESSURE 29.921 INCHES OF MERCURY  
 COPYRIGHT 1963



AMERICAN SOCIETY OF HEATING, REFRIGERATING AND AIR-CONDITIONING ENGINEERS, INC.

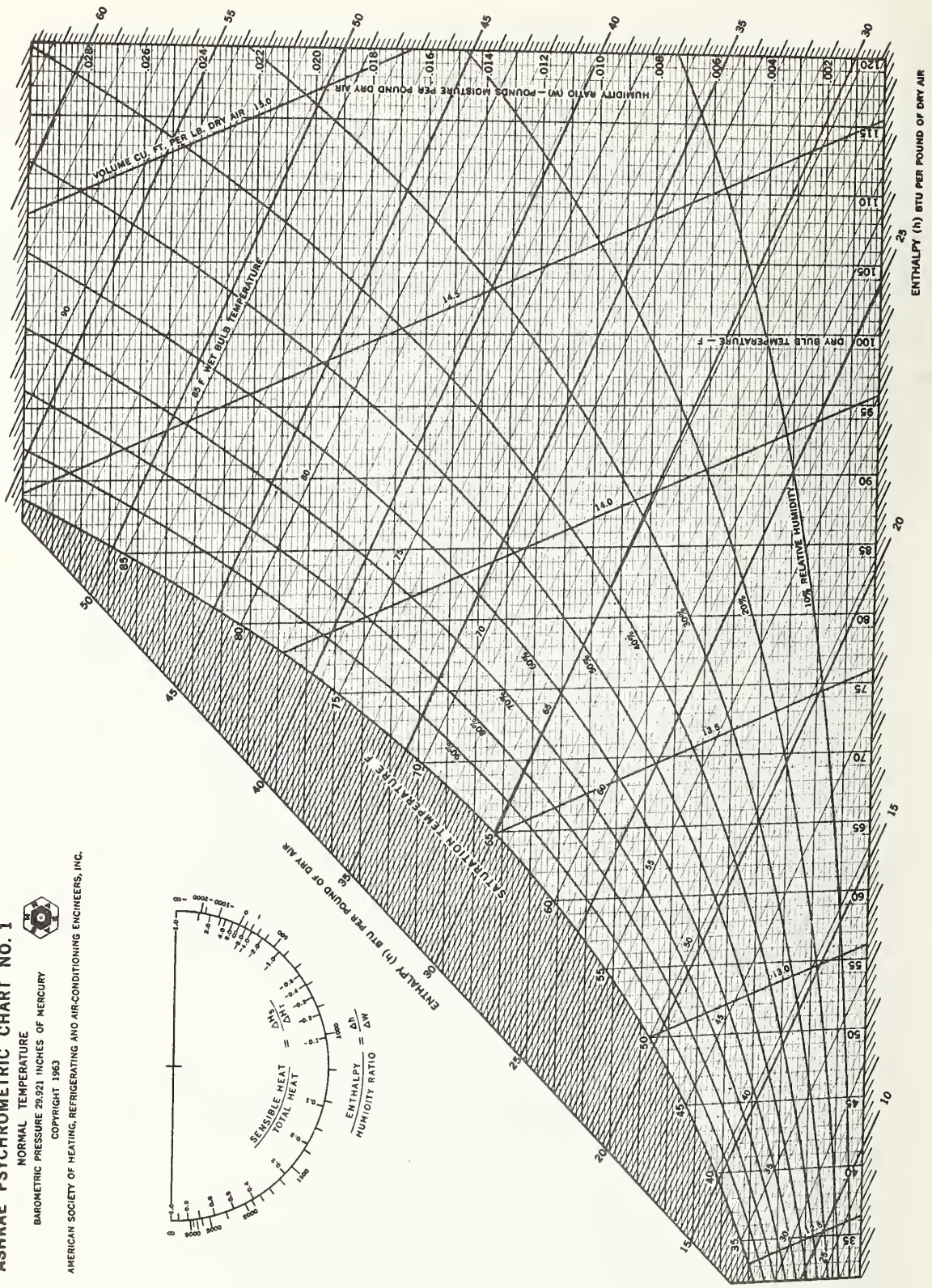
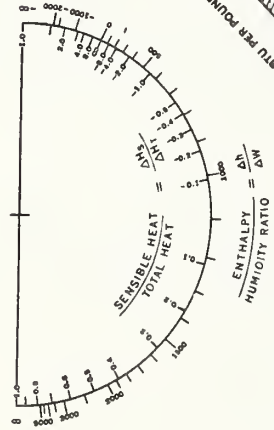

BUILD  
ON YOUR KNOWLEDGE  
WITH



# Construction Review

CONSTRUCTION REVIEW is our monthly magazine for and about the construction industry. All the major U.S. Government statistical series plus selected series from the private sector are brought together to keep you up-to-date on:

- New construction outlays
- Housing starts
- Building permits
- Contract awards
- Cost indexes
- Materials price indexes
- Union wages
- Materials output
- Employment
- Hours of work
- Weekly earnings

Our regular feature articles include the annual outlook for new construction activity, a review of the year in construction, and other analytical data. Only \$14.50 a year. Use the order form below to start your subscription today.

(please detach here)

## SUBSCRIPTION ORDER FORM

C57.509:

ENTER MY SUBSCRIPTION TO CONSTRUCTION REVIEW at \$14.50. Add \$3.65 for foreign mailing. No additional postage is required for mailing within the United States or its possessions.

Remittance Enclosed  
(Make checks payable to Superintendent of Documents)

Charge to my Deposit Account No.

Send Subscription to:

NAME—FIRST, LAST		
COMPANY NAME OR ADDITIONAL ADDRESS LINE		
STREET ADDRESS		
CITY	STATE	ZIP CODE

MAIL ORDER FORM TO:  
Superintendent of Documents  
Government Printing Office  
Washington, D.C. 20402

PLEASE PRINT



# Time Was When Energy Was Cheaper

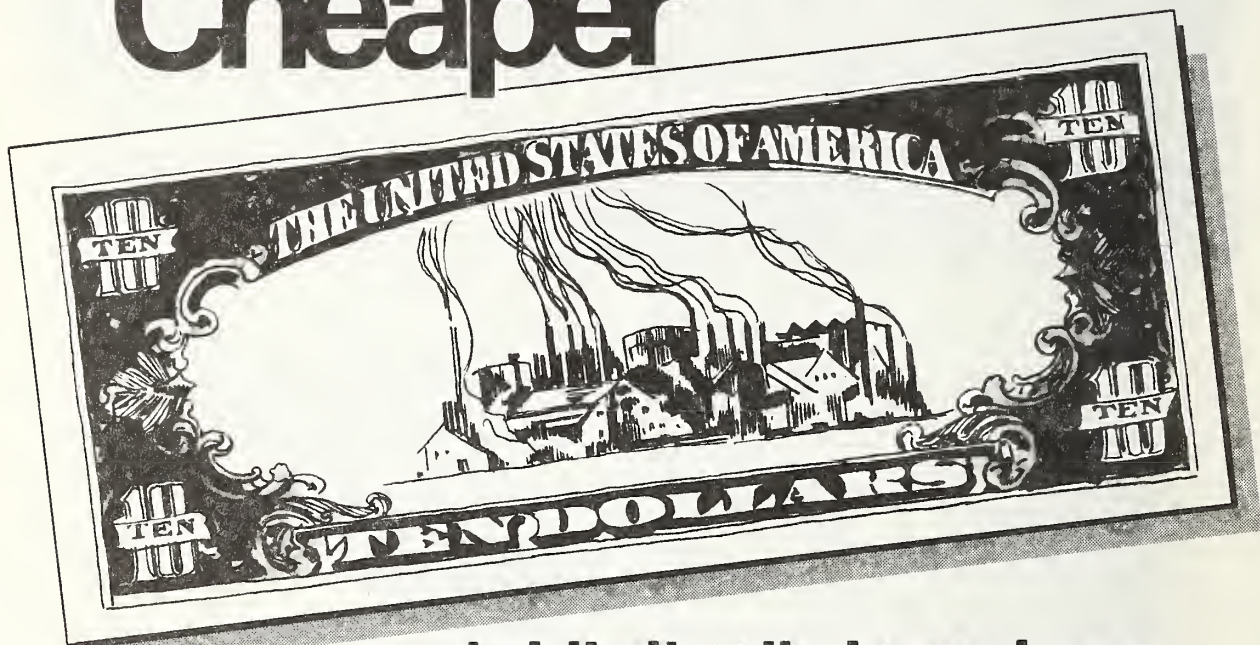

**...but that's all changed now.**

Today, increased energy costs—caused by increasing demand—boost the price of consumer goods, fuel inflation, and hurt our balance of payments.

That's why conserving energy is a must today, especially for you in the business and industry community which uses two thirds of our nation's energy.

Now . . . there's a book to tell you how to do it. It's called *EPIC—the Energy Conservation Program Guide for Industry and Commerce*. Prepared for you by the Commerce Department's National Bureau of Standards in cooperation with the Federal Energy Administration.

*EPIC* is a comprehensive handbook that can help you establish or improve an energy conservation program in your organization.

Not only industry and commerce but also hospitals, universities, research institutes, ANY organization that uses energy—and has to pay the bills—will want a copy of *EPIC*.

*EPIC* outlines in detail the steps in setting up an energy conservation program.

It contains a checklist of more than 200 Energy Conservation Opportunities—suggestions to save

energy in a dozen different areas.

*EPIC's* actual case histories of energy saving actions help you estimate your potential for saving energy—and reducing costs.

And *EPIC* contains much more—financial analysis procedures to evaluate projects, sources of information on energy conservation, engineering data and factors, an energy conservation bibliography.

Make *EPIC* part of your plan to control energy use and costs. Make *EPIC* part of your contribution to using energy resources wisely . . . so we can keep America working and growing.

To order your copy of *EPIC*, send \$2.90 per copy (check, money order or Superintendent of Documents Coupons) to Superintendent of Documents, U.S. Government Printing Office, Washington, D.C. 20402. Ask for NBS Handbook 115, *EPIC*, C13.11:115. Discount of 25% on orders of 100 copies or more.



U.S. DEPARTMENT OF COMMERCE / National Bureau of Standards  
FEDERAL ENERGY ADMINISTRATION / Conservation and Environment

U.S. DEPT. OF COMM. BIBLIOGRAPHIC DATA SHEET	1. PUBLICATION OR REPORT NO.  NBS-BSS-69	2. Gov't Accession No.	3. Recipient's Accession No.
4. TITLE AND SUBTITLE  NBSLD, the Computer Program for Heating and Cooling Loads in Buildings		5. Publication Date  July 1976	6. Performing Organization Code
7. AUTHOR(S)  Tamami Kusuda		8. Performing Organ. Report No.	
9. PERFORMING ORGANIZATION NAME AND ADDRESS  NATIONAL BUREAU OF STANDARDS DEPARTMENT OF COMMERCE WASHINGTON, D.C. 20234		10. Project/Task/Work Unit No.  4626400	11. Contract/Grant No.
12. Sponsoring Organization Name and Complete Address (Street, City, State, ZIP)  National Bureau of Standards      Housing and Urban Development Department of Commerce            451 7th Street, S.W. Washington, D.C. 20234            Washington, D.C. 20410		13. Type of Report & Period Covered  Final Report	14. Sponsoring Agency Code
15. SUPPLEMENTARY NOTES			
<p>16. ABSTRACT (A 200-word or less factual summary of most significant information. If document includes a significant bibliography or literature survey, mention it here.)</p> <p>A comprehensive computer program called NBSLD, the National Bureau of Standards Load Determination program, has been developed at NBS to reflect the time change of the many building parameters which are pertinent to accurate estimation of energy usage for heating and cooling. Current status of heating and cooling load techniques is reviewed. Of general interest are unique features of NBSLD which are not available in existing computer programs. A summary of various subroutines of NBSLD is given along with the detailed procedures for them. These subroutines constitute the recommended subroutine algorithms of the ASHRAE Task Group on Energy Requirements. Complete Fortran listing of NBSLD and data preparation forms are given for those who wish to use the program. The NBSLD computation is on the basis of the detailed solution of simultaneous heat balance equations at all the interior surfaces of a room or space. Transient heat conduction through exterior walls and the interior structures is handled by using conduction transfer functions. The use of heat balance equations, although time consuming in calculation, can avoid the vagueness and uncertainties inherent in the more popularly used weighting factor approach. In addition, it is more accurate for a specific building design.</p>			
<p>17. KEY WORDS (six to twelve entries; alphabetical order; capitalize only the first letter of the first key word unless a proper name; separated by semicolons) ASHRAE Task Group on Energy Requirements; conduction transfer functions; heating and cooling load; National Bureau of Standards Heating and Cooling Load Computer Program</p>			
<p>18. AVAILABILITY            <input checked="" type="checkbox"/> Unlimited</p> <p><input type="checkbox"/> For Official Distribution. Do Not Release to NTIS</p> <p><input checked="" type="checkbox"/> Order From Sup. of Doc., U.S. Government Printing Office Washington, D.C. 20402, SD Cat. No. C13. 2972:69</p> <p><input type="checkbox"/> Order From National Technical Information Service (NTIS) Springfield, Virginia 22151</p>		<p>19. SECURITY CLASS (THIS REPORT)</p> <p>UNCLASSIFIED</p>	<p>21. NO. OF PAGES</p> <p>398</p>
<p>20. SECURITY CLASS (THIS PAGE)</p> <p>UNCLASSIFIED</p>		<p>22. Price</p> <p>\$4.60</p>	

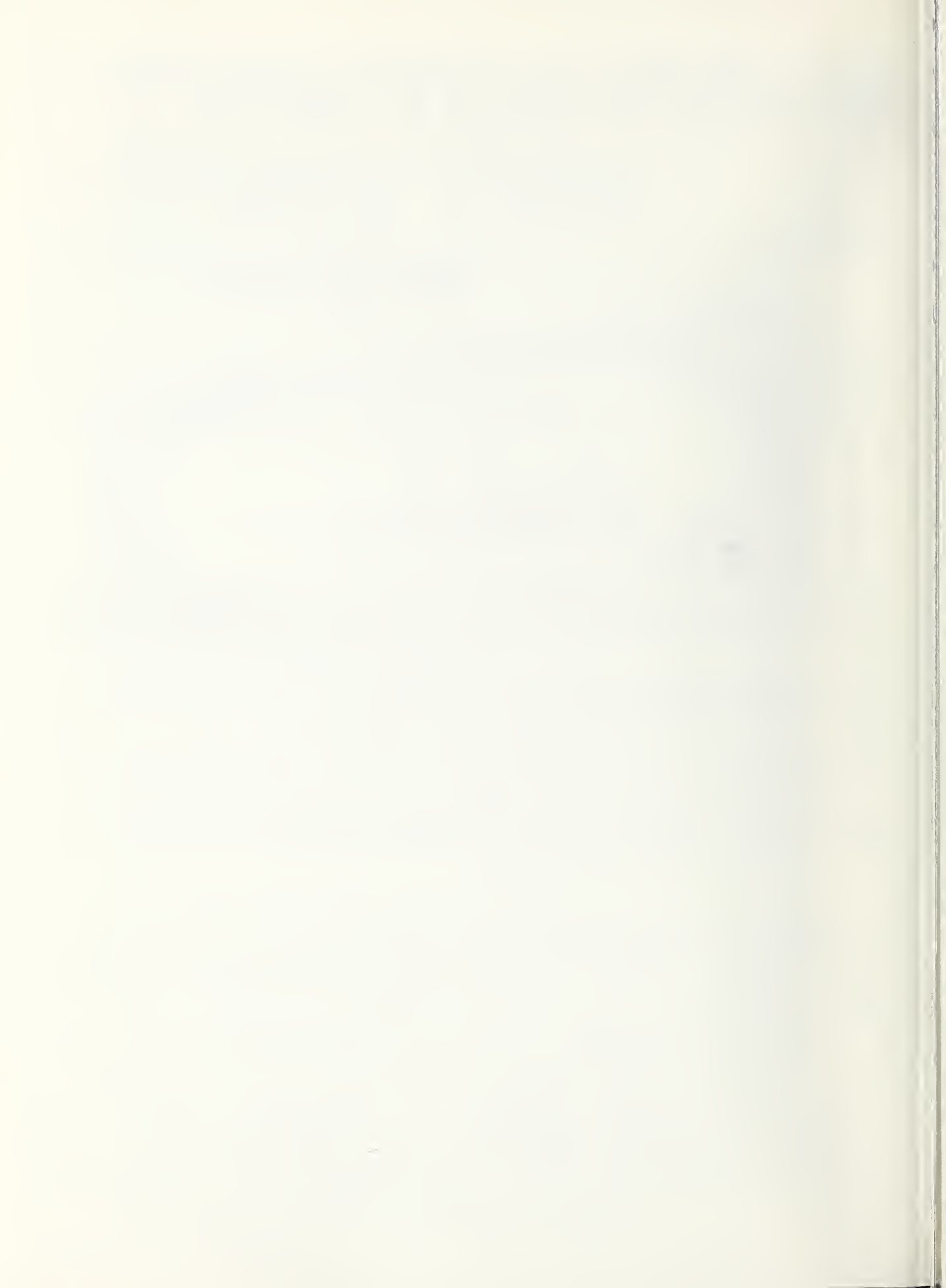



**ANNOUNCEMENT OF NEW PUBLICATIONS IN  
BUILDING SCIENCE SERIES**

Superintendent of Documents,  
Government Printing Office,  
Washington, D.C., 20402

Dear Sir:

Please add my name to the announcement list of new publications to be issued in the series: National Bureau of Standards Building Science Series.

Name.....

Company.....

Address.....

City..... State..... Zip Code.....

(Notification key N-339)

(cut here)

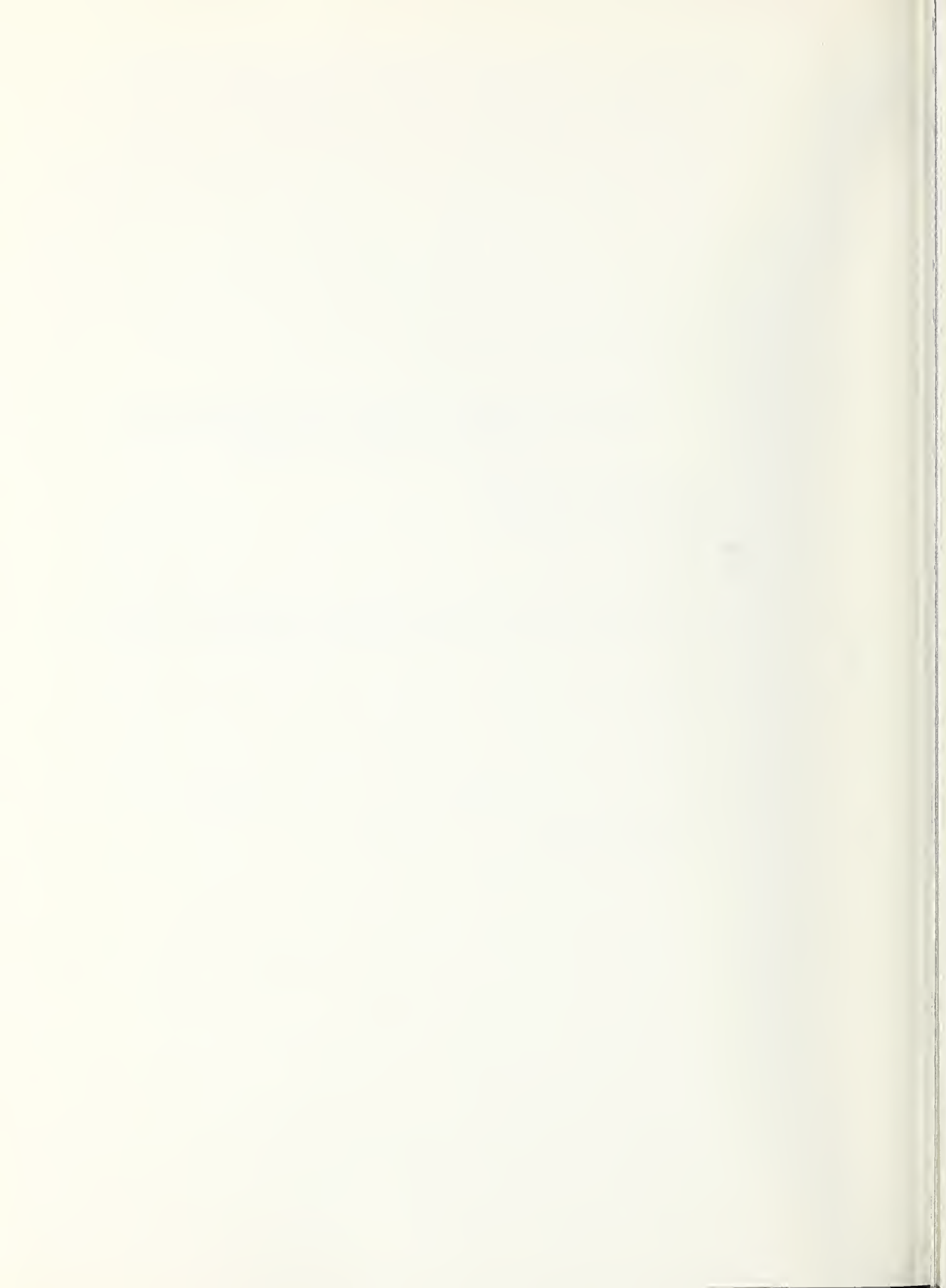





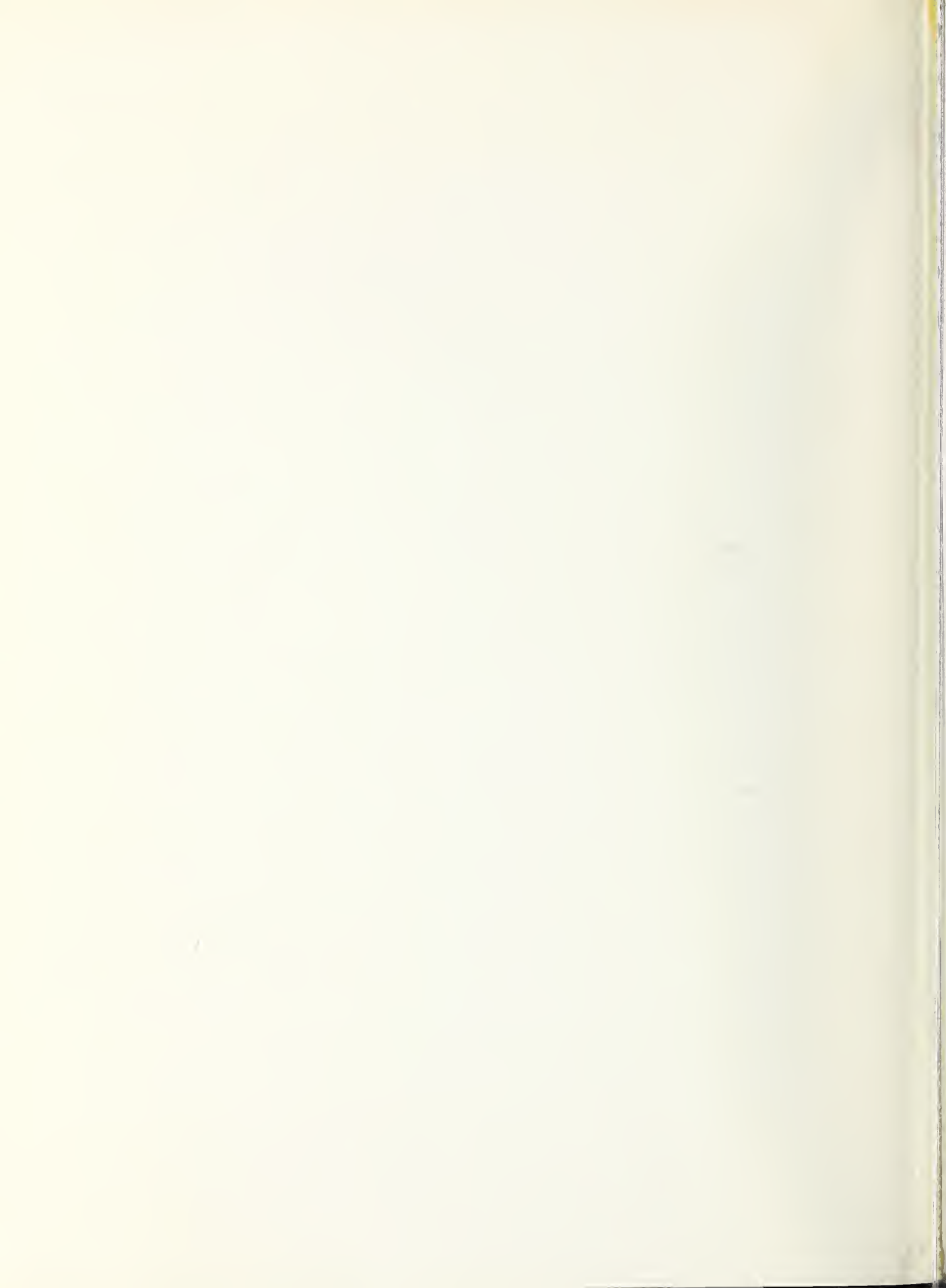

# NBS TECHNICAL PUBLICATIONS

## PERIODICALS

**JOURNAL OF RESEARCH** reports National Bureau of Standards research and development in physics, mathematics, and chemistry. It is published in two sections, available separately:

• **Physics and Chemistry (Section A)**

Papers of interest primarily to scientists working in these fields. This section covers a broad range of physical and chemical research, with major emphasis on standards of physical measurement, fundamental constants, and properties of matter. Issued six times a year. Annual subscription: Domestic, \$17.00; Foreign, \$21.25.

• **Mathematical Sciences (Section B)**

Studies and compilations designed mainly for the mathematician and theoretical physicist. Topics in mathematical statistics, theory of experiment design, numerical analysis, theoretical physics and chemistry, logical design and programming of computers and computer systems. Short numerical tables. Issued quarterly. Annual subscription: Domestic, \$9.00; Foreign, \$11.25.

**DIMENSIONS/NBS** (formerly *Technical News Bulletin*)—This monthly magazine is published to inform scientists, engineers, businessmen, industry, teachers, students, and consumers of the latest advances in science and technology, with primary emphasis on the work at NBS. The magazine highlights and reviews such issues as energy research, fire protection, building technology, metric conversion, pollution abatement, health and safety, and consumer product performance. In addition, it reports the results of Bureau programs in measurement standards and techniques, properties of matter and materials, engineering standards and services, instrumentation, and automatic data processing.

Annual subscription: Domestic, \$9.45; Foreign, \$11.85.

## NONPERIODICALS

**Monographs**—Major contributions to the technical literature on various subjects related to the Bureau's scientific and technical activities.

**Handbooks**—Recommended codes of engineering and industrial practice (including safety codes) developed in cooperation with interested industries, professional organizations, and regulatory bodies.

**Special Publications**—Include proceedings of conferences sponsored by NBS, NBS annual reports, and other special publications appropriate to this grouping such as wall charts, pocket cards, and bibliographies.

**Applied Mathematics Series**—Mathematical tables, manuals, and studies of special interest to physicists, engineers, chemists, biologists, mathematicians, computer programmers, and others engaged in scientific and technical work.

**National Standard Reference Data Series**—Provides quantitative data on the physical and chemical properties of materials, compiled from the world's literature and critically evaluated. Developed under a world-wide

program coordinated by NBS. Program under authority of National Standard Data Act (Public Law 90-396).

NOTE: At present the principal publication outlet for these data is the *Journal of Physical and Chemical Reference Data* (JPCRD) published quarterly for NBS by the American Chemical Society (ACS) and the American Institute of Physics (AIP). Subscriptions, reprints, and supplements available from ACS, 1155 Sixteenth St. N. W., Wash. D. C. 20056.

**Building Science Series**—Disseminates technical information developed at the Bureau on building materials, components, systems, and whole structures. The series presents research results, test methods, and performance criteria related to the structural and environmental functions and the durability and safety characteristics of building elements and systems.

**Technical Notes**—Studies or reports which are complete in themselves but restrictive in their treatment of a subject. Analogous to monographs but not so comprehensive in scope or definitive in treatment of the subject area. Often serve as a vehicle for final reports of work performed at NBS under the sponsorship of other government agencies.

**Voluntary Product Standards**—Developed under procedures published by the Department of Commerce in Part 10, Title 15, of the Code of Federal Regulations. The purpose of the standards is to establish nationally recognized requirements for products, and to provide all concerned interests with a basis for common understanding of the characteristics of the products. NBS administers this program as a supplement to the activities of the private sector standardizing organizations.

**Federal Information Processing Standards Publications (FIPS PUBS)**—Publications in this series collectively constitute the Federal Information Processing Standards Register. Register serves as the official source of information in the Federal Government regarding standards issued by NBS pursuant to the Federal Property and Administrative Services Act of 1949 as amended, Public Law 89-306 (79 Stat. 1127), and as implemented by Executive Order 11717 (38 FR 12315, dated May 11, 1973) and Part 6 of Title 15 CFR (Code of Federal Regulations).

**Consumer Information Series**—Practical information, based on NBS research and experience, covering areas of interest to the consumer. Easily understandable language and illustrations provide useful background knowledge for shopping in today's technological marketplace.

**NBS Interagency Reports (NBSIR)**—A special series of interim or final reports on work performed by NBS for outside sponsors (both government and non-government). In general, initial distribution is handled by the sponsor; public distribution is by the National Technical Information Service (Springfield, Va. 22161) in paper copy or microfiche form.

Order NBS publications (except NBSIR's and Bibliographic Subscription Services) from: Superintendent of Documents, Government Printing Office, Washington, D.C. 20402.

## BIBLIOGRAPHIC SUBSCRIPTION SERVICES

The following current-awareness and literature-survey bibliographies are issued periodically by the Bureau:

**Cryogenic Data Center Current Awareness Service**

A literature survey issued biweekly. Annual subscription: Domestic, \$20.00; foreign, \$25.00.

**Liquefied Natural Gas.** A literature survey issued quarterly. Annual subscription: \$20.00.

**Superconducting Devices and Materials.** A literature

survey issued quarterly. Annual subscription: \$20.00. Send subscription orders and remittances for the preceding bibliographic services to National Bureau of Standards, Cryogenic Data Center (275.02) Boulder, Colorado 80302.

**Electromagnetic Metrology Current Awareness Service** Issued monthly. Annual subscription: \$24.00. Send subscription order and remittance to Electromagnetics Division, National Bureau of Standards, Boulder, Colo. 80302.

**U.S. DEPARTMENT OF COMMERCE**  
**National Bureau of Standards**  
Washington, D.C. 20234

OFFICIAL BUSINESS

Penalty for Private Use, \$300

POSTAGE AND FEES PAID  
U.S. DEPARTMENT OF COMMERCE  
COM-215



SPECIAL FOURTH-CLASS RATE  
BOOK



75 YEARS  
**NBS**  
1901-1976