

HealthCare Standards Landscape User Guide

**Elizabeth Fong
Roy Morgan
Thomas Rhodes
Clement Ridoret
Hai Tang**

**Information Technology Laboratory
National Institute of Standards and Technology
Gaithersburg MD 20899**

December 2006



**U.S. Department of Commerce
Technology Administration
National Institute of Standards and Technology**

This version of the HealthCare Standards Landscape User Guide includes new features in the areas of: establishing and administering groups and subgroups; ownership, management, and disposition of content; and, in defining and using content relationships to search for Landscape content.

Users may provide feedback either via the Landscape menu selection “User Support/Contact Us,” or by contacting the HCSL System Administrator at hcsl_admin@nist.gov.

Disclaimer: Any mention of commercial products, standards, organizations, projects or other material in this document or in the HealthCare Standards Landscape is for information only; it does not imply recommendations or endorsement by NIST, nor does it imply that the products mentioned are necessarily the best available for the purpose.

HealthCare Standards Landscape User Guide

**Elizabeth Fong
Roy Morgan
Thomas Rhodes
Clement Ridoret
Hai Tang**

**Information Technology Laboratory
National Institute of Standards and Technology
Gaithersburg MD 20899**

Abstract

This document provides a tutorial and guide for using the features of the HealthCare Standards Landscape (HCSL) web-based application. The HCSL, also called the “Landscape,” was developed by the National Institute of Standards and Technology (NIST) to provide and demonstrate to the healthcare informatics community a web-based capability for finding and publishing information on healthcare standards and related information. This Users Guide describes how to use the Landscape web site to search, retrieve, and publish healthcare standards’ information in the Landscape. It also provides information on establishing and managing organizational Groups and Subgroups of users and content within the Landscape, for Group and Subgroup administrators.

Keywords:

Health informatics, health informatics standards, health IT; health information technology; healthcare standards; healthcare standards information; HCSL; HealthCare Standards Landscape; healthcare standards landscape; standards; standards development; standards repository; user guide; web-based standards repository.

Table of Contents

1	Introduction.....	1
1.1	Overview of HealthCare Standards Landscape	1
1.2	Approach.....	1
1.3	Purpose of HCSL	2
1.4	Impact of the HCSL	2
1.5	HCSL System Architecture.....	2
1.6	Type of Information in the HCSL Repository	3
1.7	Accessing the HCSL Web Site	4
1.8	Who May Access HCSL Information.....	5
1.9	The HCSL Home and Welcome Pages.....	5
2	Overview of HCSL Features.....	6
3	Main Menu for Anonymous Users	9
4	Search and Browse Content.....	9
4.1	Search for Documents.....	11
4.1.1	Method 1 – Boolean Query.....	12
4.1.2	Method 2 – Pattern Search Using a Search String.....	16
4.1.3	Finding All Documents with the Same Indexed Element and Value	17
4.1.4	Browse a Document’s Relationships	19
4.2	Search for Organizations.....	20
4.2.1	Illustration of Method 1 Boolean Query Using “ALL”	22
4.2.2	Illustration of Method 1 Boolean Queries Using Specific Values.....	22
4.2.3	Illustration of Method 2 Organization Search Using a Search String	23
4.2.4	Finding All Organizations with the Same Indexed Element and Value ...	24
4.2.5	Browse an Organization’s Relationships	24
4.3	Search for Portfolios	24
4.3.1	Illustration of Portfolio Search Using a Search String.....	24
4.3.2	Browse a Portfolio’s Relationships.....	25
4.4	Search for Content by Relationships.....	26
4.5	Browse Groups and Subgroups.....	30
4.6	Browse HealthCare Domains.....	31
5	Users, Roles, Registration, Groups and Subgroups.....	33
5.1	Landscape User Types	33
5.2	Landscape Groups and Subgroups.....	34
5.2.1	Types of Membership in Groups and Subgroups	34
5.3	User Roles and Privileges	34
5.3.1	System Administrator (SA).....	34
5.3.2	Anonymous User (AU).....	35
5.3.3	Registered User (RU).....	35
5.3.4	Group Member (GM).....	35
5.3.5	Group Administrator (GA)	36
5.3.6	Subgroup Member (SGM)	36
5.3.7	Subgroup Administrator (SGA).....	36
5.4	User Registration	36
5.4.1	Separate HCSL User Accounts.....	37
5.5	Registered User Login to HCSL	37

5.5.1	Login to Guest Group	38
5.5.2	Login to a Group or Subgroup	40
5.5.3	Log Out of a Group or Subgroup	42
5.6	Joining an HCSL Group.....	42
5.7	Joining an HCSL Subgroup	43
5.7.1	Joining a Subgroup within a Group	44
5.7.2	Joining a Subgroup within a Subgroup.....	45
5.7.3	Create a Group	45
6	Menus for Group and Subgroup Members.....	45
6.1	Member Area Menu Selections	46
6.1.1	My Content Menu Selection	47
6.1.2	My Group Menu Selection.....	49
6.1.3	My Settings Menu Selection.....	51
6.1.4	Switch Groups Menu Selection	52
6.1.5	Browse Groups Menu Selection	53
6.1.6	Join Another Group Menu Selection	53
6.1.7	Create a Group Menu Selection.....	53
6.2	Add Content Menu Selection.....	54
6.2.1	Add a Document Instance.....	54
6.2.2	Add an Organization Instance.....	56
6.2.3	Add a Portfolio Instance	58
6.3	Update or Delete Content.....	59
6.4	Add, Update, and Delete Relationships Between Content	60
6.4.1	Adding a Relationship Between Content.....	60
6.4.2	Update or Delete a Relationship Between Content.....	66
6.4.3	Types of Content Relationships	68
6.5	XML Menu Selection	70
7	Establishing and Managing Groups and Subgroups.....	71
7.1	Establishing a Group.....	71
7.2	Member Area Menu Selections for Group/Subgroup Administrators.....	73
7.2.1	My Group Menu Selection.....	73
7.3	Modifying Group/Subgroup Default Content Permissions.....	76
7.4	Adding a Subgroup	76
7.5	Removing a Subgroup.....	80
7.6	Removing a Group.....	81
8	User Support Menu	82
8.1	User Guide Menu	83
8.2	Presentations Menu.....	83
8.3	FAQ (Frequently Asked Questions) Menu	83
8.4	Acronyms and Links Menu.....	83
8.5	Contact Us Menu	83
9	Background Menu	84
10	Related Activities Menu	85
10.1	AHRQ Yellow Book Menu	85
10.2	Conformance Menu	86
11	Summary.....	86
12	Appendix A - XML Schemas	88
12.1	The Document Schema.....	88

12.2	The Organization Schema.....	94
12.3	The Portfolio Schema	99
13	Appendix B - Glossary.....	100
14	Appendix C – FAQ, Frequently Asked Questions.....	103
15	Appendix D - User Roles and Privileges	118
15.1	System Administrator (SA).....	118
15.2	Anonymous User (AU).....	118
15.3	Registered User (RU).....	119
15.4	Guest User (GU)	119
15.5	Group Member (GM).....	119
15.6	Group Administrator (GA)	120
15.7	Subgroup Member (SGM).....	120
15.8	Subgroup Administrator (SGA).....	121
16	Appendix E - HTMLArea Editor	123
17	Index.....	126

List of Figures

Figure 1	HCSL System Architecture	3
Figure 2	HCSL Information Types and Sample Relationships	4
Figure 3	HCSL Home Page	5
Figure 4	HCSL Welcome Page.....	6
Figure 5	Main Menus for Anonymous Users	9
Figure 6	Main Menus with Search Content Menu Expanded.....	10
Figure 7	Document Search Page Showing Search Methods 1 and 2.....	11
Figure 8	Document Search Results List – (partial list).....	13
Figure 9	Contents of the Document Record “ADA TR 1016”	14
Figure 10	Boolean Document Query Using Specific Search-Term Values	15
Figure 11	Boolean Document Query Using Multiple Search-Term Values.....	15
Figure 12	Boolean Search Query Using OR with Multiple “HealthCare Domain” Values	16
Figure 13	Sample Document Query Using Method 2	16
Figure 14	Contents of Document “HL7 Messaging”.....	18
Figure 15	List of Documents having the HealthCare Domain “Insurance”	19
Figure 16	Examples of Relationships for HL7 Organization	20
Figure 17	Organization Query Using Search Method 1 and Default Value “ALL”.....	21
Figure 18	Organization Query Using Search Method 1 and Specific Index-Term Values	22
Figure 19	Organization Query Using Search Method 1 and “OR” Between Indexed Terms	23
Figure 20	Organization Query Using Search Method 2	23
Figure 21	Portfolio Search Screen	24
Figure 22	Sample Portfolio Search Using Search String of “HL7”	25
Figure 23	Results of Portfolio Search Using the Search String “HL7”	25
Figure 24	Content of “HL7” Portfolio.....	25
Figure 25	Selecting Object Types for a Relationship Search	27
Figure 26	Selecting Source and Target Objects and Relationship(s)	28

Figure 27 Search Results for “Relationship Not Found”	29
Figure 28 Search Results for “Relationship Found”	29
Figure 29 List of Landscape Groups (Partial).....	30
Figure 30 Expanded Lists of the HHS Group and Subgroups	30
Figure 31 Group Information Display – NIST	31
Figure 32 Information Display for a Group/Subgroup Member.....	31
Figure 33 List of HealthCare Domains (partial listing).....	32
Figure 34 List of Documents with the HC Domain “Accounting/Billing”	32
Figure 35 List of Organizations with the HC Domain “Accounting/Billing”	33
Figure 36 User Registration Form	37
Figure 37 Login Screen for Registered Users.....	38
Figure 38 Guest Group Login Screen for Registered User.....	39
Figure 39 Main Menus Showing “Member Area” Menu Selections for Registered “Guest” Users.....	39
Figure 40 Login Screen to Enter Username and Password.....	40
Figure 41 Select Group or Subgroup Screen – Login continued	41
Figure 42 Main Menu Selections for a Group/Subgroup Member	42
Figure 43 Logout.....	42
Figure 44 Selecting an HCSL Group to Join	43
Figure 45 Join a Group – Request Sent Notification Message	43
Figure 46 Join a Subgroup Display.....	44
Figure 47 Main Menu Selections for a Group/Subgroup Member	45
Figure 48 “Member Area” Menu Selections for a Group/Subgroup Member.....	46
Figure 49 “My Content” Display Listing Member Content	47
Figure 50 “My Content Submenu” – Change Content Permissions or Transfer Ownership	48
Figure 51 “My Group” Information Display	50
Figure 52 “My Group Menu” – Leaving a Group or Subgroup	51
Figure 53 “My Group Menu” – Leaving a Group or Subgroup – You Have Been Removed	51
Figure 54 “My Settings” Display.....	52
Figure 55 Switch Group.....	53
Figure 56 Add Content Drop-Down Menus	54
Figure 57 Register a Document Instance	55
Figure 58 Register an Organization	57
Figure 59 Register a Portfolio.....	58
Figure 60 Sample Document showing Update and Delete Controls	59
Figure 61 Form for Updating a Document	60
Figure 62 Create Relationships - Select Relationship Pair (Document-to-Document illustrated)	61
Figure 63 Selecting Specific Documents and a Relationship	62
Figure 64 Selecting a Specific Organization to Document Relationship	63
Figure 65 Effects of Content and Relationship Permissions on Making a Relationship..	65
Figure 66 Example of Relationships for the Organization HL7	67
Figure 67 Example of Updating a Relationship Between the HL7 Organization and a Document.....	67
Figure 68 Enter and Register XML Instance Data.....	70
Figure 69 Creating a Group	72

Figure 70 Example of “My Group” Display for the Group Administrator of the DHHS Group	73
Figure 71 “Remove Member” Alert Message to an Administrator	75
Figure 72 My Group DHHS – Default Access Permissions for Group/Subgroup Content	76
Figure 73 Member Area - My Group Display – Add a Subgroup	77
Figure 74 Member Area - My Group Display –Subgroups and Administrators	79
Figure 75 Member Area - My Group Display – Changing Subgroup Administrator.....	80
Figure 76 Confirm “Delete a Subgroup” Message	81
Figure 77 User Support Menus	82
Figure 78 “Contact Us” Display	83
Figure 79 Background – Overview and Approach	84
Figure 80 Related Activities Menu	85
Figure 81 XML Schema for Document	93
Figure 82 XML Schema for Organization (“Entity”).....	98
Figure 83 XML Schema for Portfolio.....	99
Figure 84 HTMLArea Editor initial window.....	123
Figure 85 WSIWYG View of Sample Content with HTML styling.	124
Figure 86 Text View of Sample Content with HTML Tags.....	124
Figure 87 Sample Edited Content Pasted into New Document Record (partial contents)	125

List of Tables

Table 1 HCSL Content Relationships and Inverse Relationships	69
--	----

HealthCare Standards Landscape User Guide

1 Introduction

The healthcare (HC) industry has many standards development organizations (SDOs) developing specifications and standards for healthcare informatics and information exchange covering a wide spectrum of healthcare activities. The many development efforts and large number of healthcare standards that exist or are in development, make it very difficult to monitor and track the overall healthcare standards landscape.

This in turn impedes harmonization efforts among SDOs and frustrates efforts by users and organizations to identify, understand, and adopt needed standards. By improving the availability and dissemination of healthcare standards information, many of these problems can be relieved and collaboration and implementation efforts can be improved among developers, implementers, and users of healthcare standards.

To address this need, the National Institute of Standards and Technology (NIST) has developed a prototype web-based application and repository of healthcare informatics standards information. This application and repository is referred to as the HealthCare Standards Landscape (HCSL) or simply “The Landscape.”

This document provides a user guide on how to navigate the web site, and publish and retrieve information on healthcare standards, development organization(s), organizations adopting and using these standards, and on other relevant healthcare standards information. It also provides information for system administrators on how to establish Groups and Subgroups, and add and manage content and users within a Group and Subgroup. These capabilities are discussed further in Section 7.

1.1 Overview of HealthCare Standards Landscape

The development of standards for clinical and administrative information exchange, and simplified methods to access healthcare information and services is crucial in making healthcare safe and available to all. In order to better disseminate and understand current activities in the standardization field, and to foster better coordination and cooperation among the many participants in the development and use of healthcare standards, the HealthCare Standards Landscape tool has been developed.

1.2 Approach

NIST collaborated with various healthcare standards developers and stakeholders to define, develop, test, and demonstrate the prototype HCSL capability. This included the ANSI Health Information Technology Standards Board (HITSB), the Agency for Health Research and Quality (AHRQ), and the e-Gov Consolidated Health Informatics (CHI) program, as well as monitoring and engaging other SDOs and HC organizations, including the Healthcare Information and Management Systems Society (HIMSS), Health

Level Seven (HL7), the Institute of Electrical and Electronics Engineers (IEEE-1073), and the National Alliance for Health Information Technology (NAHIT).

The HCSL is available and operational on the Web, with actual data to demonstrate its overall capabilities, for users to search for and publish additional HC standards information into the HCSL repository. Later, NIST plans to provide an open source version of the HCSL software and make this available for downloading and use by other organizations.

1.3 Purpose of HCSL

The current HCSL is meant to provide and demonstrate a web-based capability to those interested in finding and publishing information on health informatics standards and other related information, including information on standards development organizations, implementers, end-user organizations that have adopted and implemented healthcare standards, and on standards' portfolios (i.e., collection of healthcare standards, guidelines, etc.) that organizations have adopted. The HCSL also includes links to other healthcare and standards resources.

The current HCSL contains a modest amount of information to demonstrate its capabilities. However, it is available for users and organizations to add additional information to the HCSL repository (database) so as to enhance its usefulness to all stakeholders. Over time, NIST envisions that the HCSL will grow to become a comprehensive resource of relevant health informatics and healthcare standards' information for the wider community of healthcare stakeholders.

1.4 Impact of the HCSL

The HCSL provides for a concise and comprehensive source of web-based information on healthcare standards information, and can leverage other healthcare standards resources by providing web-links to these resources. Thus, the HCSL information can support development, implementation, and adoption of healthcare standards by enabling users, system developers, and integrators to quickly find standards information and become more knowledgeable of existing and emerging standards and their use by healthcare organizations and applications.

1.5 HCSL System Architecture

The Landscape is a web application composed of a server and associated database that can be accessed by users through a web-browser over the Internet. The major system components and key information flows are shown below in Figure 1.

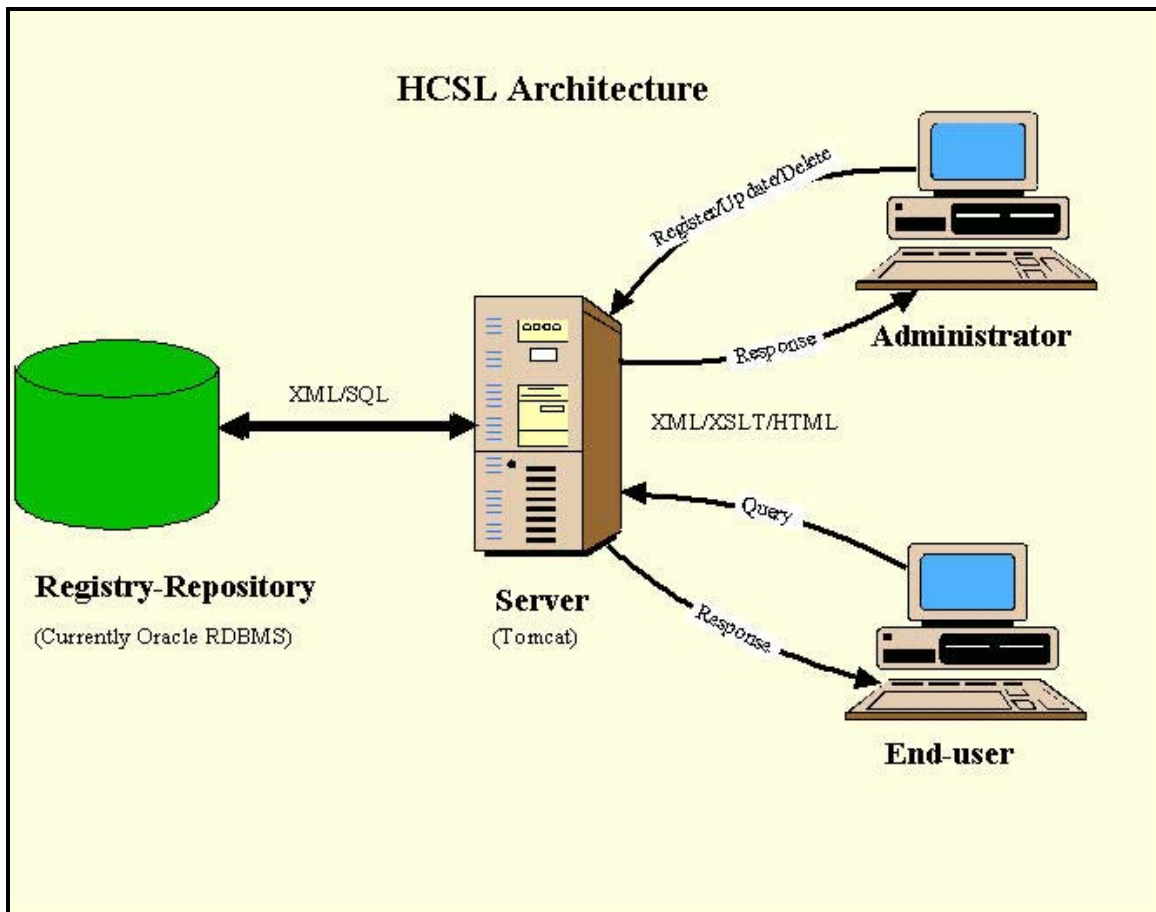

Figure 1 HCSL System Architecture

1.6 Type of Information in the HCSL Repository

The HCSL repository contains information about and related to health informatics standards. The HCSL **does not** include the actual standards themselves, since these are usually available for a fee from standards' development organizations. The type of information contained in the HCSL repository includes information about:

- Health informatics standards and links to where they can be obtained,
- Organizations involved in developing and fostering the implementation of the standards,
- Organizations adopting and using these standards,
- Portfolios of standards adopted or used by organizations,
- Other relevant healthcare standards' information.
- Relationships among Landscape information.

Currently, the HCSL repository supports three types of information records, or content objects, as described below:

- **Document** - about healthcare information, e.g., specifications, standards, regulations, guidelines, implementation guides, and code lists.

- **Organization** – about healthcare organizations, e.g., development organizations, consortia, government groups, and user groups.
- **Portfolio** – about collections of documents (standards, guidelines and the like) developed, maintained, or used by an Organization; e.g., the group of standards consisting of HL7 Messaging, DICOM, and LOINC are part of the Portfolios for the Connecting-for-Health (C-f-H) and the Consolidated Health Informatics (CHI) organizations.

These three types of information objects (Document, Organization, Portfolio) comprise the major elements of the current "information model" of the HCSL. Schemas for these three types of content objects may be found in "Appendix A - XML Schemas."

In addition, the HCSL supports Relationships. A Relationship describes a relationship between pairs of information objects. Some examples are: an Organization *develops* or *uses* a Document (perhaps a standard or code list); a Document *is published by* an Organization; a Document *references* another Document.

Figure 2, shows the three types of information objects and indicates some of the possible relationships that may be made between them.

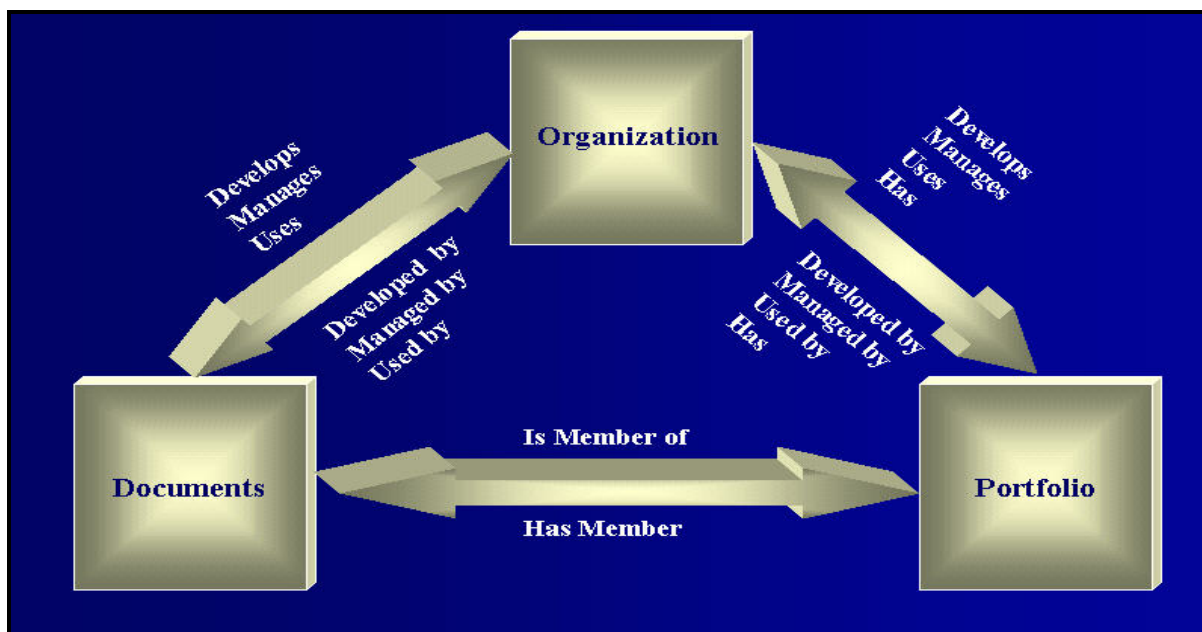

Figure 2 HCSL Information Types and Sample Relationships

1.7 Accessing the HCSL Web Site

The HCSL is hosted on a public server at NIST, Gaithersburg, Maryland. To access the HCSL, a user requires:

- A web-browser (e.g., Netscape, Firefox, or Internet Explorer) capable of supporting HTML/HTTP, Java, Java Script, and XML/XSLT, and
- A connection to the Internet.

The following URLs are used to access the HCSL site: <http://www.nist.gov/hcsl>, and <http://hcsl.sdct.nist.gov>.

1.8 Who May Access HCSL Information

Anyone may access the HCSL to search for information. Users who are not registered with the HCSL are considered "**Anonymous Users**" and may browse or search the repository without having to login with a username or password. However, they cannot add, delete, or change HCSL content, or make relationships among any content.

Users who register with the HCSL (i.e. "**Registered Users**") and become members of an HCSL Group (i.e. "**Group Members**") may search for content, add new content, and update or delete their content within a Group. "**Group Members**" may also make relationships among content that they submitted, or have been given permission to modify, and may also change their username or password. These various HCSL features are described later in other sections of this document.

1.9 The HCSL Home and Welcome Pages

The HCSL Home page is shown below in Figure 3. A user enter the HCSL system through the Home page by clicking anywhere within the rectangular-border containing the HCSL title and logo. This action will bring a user to the Landscape Welcome page containing the Main Menu selections, as shown in Figure 4.



Figure 3 HCSL Home Page

Information Technology Laboratory
Software Diagnostics and Conformance Testing Division

NIST
National Institute of Standards and Technology

HealthCare Standards Landscape

Home
Login/Logout
Register
Search Content
User Support
Background
Related Activities

Welcome

Welcome to the NIST HealthCare Standards Landscape (HCSL or "Landscape"), a public web-based repository containing information about healthcare standards, the organizations that develop, promote, or use these standards, related healthcare standards' information, and links to external resources. The HCSL provides capabilities for users to search for or publish information on healthcare standards and related information, thus providing a central resource of useful information for the health informatics community (e.g. standards developers, implementers, and end-user organizations).

The Landscape is being developed with the contributions and support of a number of organizations. A list of them is [here](#).

All users may browse or search the HCSL information repository as "Guests" without needing to register or to login. Simply select **Search Content** from the menu to browse or search for information.

To add or publish information content in HCSL, a user must first register with HCSL and then join or create a Group, in which to add and manage their content. The Registration process is briefly described below, on the user [Registration](#) page, and on the [FAQ](#) page under the **User Support** menu.

** Note for Registered Users: After logging in with your User Name and Password, you must select one of the Groups or Subgroups that you belong to in order to complete the Login process. When the log-in is complete, you may add and manage information within your Group or Subgroup. **

The HealthCare Standards Landscape was developed as part of the NIST Information Technology Laboratory's Health Information Technology (HIT) project (www.nist.gov/ehealth). Through this project, NIST supports requirements of the broader healthcare community by pursuing critical measurements, standards, and technology to improve the quality, safety and cost-effectiveness of healthcare delivery systems and processes.

Because the Healthcare Standards Landscape is continuing to evolve, we welcome your comments and suggestions on how we can improve the Landscape capabilities further. Please send your feedback to the [HCSL Administrator](#).

A brief description of key HCSL features and capabilities is given below. Further information about these and other HCSL capabilities, and how they are used, can be found in the [FAQ](#) and [User Guide](#), available via selections under the **User Support** menu.

Latest News - June 12, 2006 [\(Click here to see more information\)](#)

Figure 4 HCSL Welcome Page

The Main Menu, shown in the Welcome page, Figure 4, is available to all non-registered, or "Anonymous," HCSL users, and provides menu selections for searching and other functions, which are described in the following Sections (Note, registered users and members of Groups are described further in Section 5).

2 Overview of HCSL Features

The HCSL capabilities allow users to publish and search for content, and support system administration functions. A brief description of HCSL features is given below:

1. **Browsing** - A user can browse the HCSL repository for information content describing healthcare standards related "Documents", "Organizations", and "Portfolios." "Relationships" that exist between documents, organizations, and portfolios can also be viewed.
2. **Searching** - A user can search for content in the HCSL repository using either Boolean queries, a pattern search using a text search-string on the content name or keywords, or by using content relationships to find content having a specific relationship between them.

3. **Displaying content with the same indexed data element value** – Certain data elements and their values are indexed to allow finding content containing these elements and values. For example, the data element “Document Type,” within a document object, has a list of values that describe various kinds of document types, e.g., report, standard, photograph, etc. For each document type, such as a report, one can easily find and view all other documents of type “report” that are in the repository.
4. **Entering new or updating data** - A registered user can add, modify, and delete content for Documents, Organizations, Portfolios, and Relationships, which the user entered (i.e. “owns”) within their Group or Subgroup, or for content that they have permission to modify.
5. **Defining and searching for relationships** - A user can define Relationships among content in the Landscape that provides further information about these content, and which may be used in searching for content by relationships. The Relationship search capability allows users to discover information by the type of relationship defined between Organization, Document, and Portfolio objects. For example, as shown previously in Figure 2, an “Organization” object may have one or more “Document” objects that it “*uses,*” “*manages,*” or “*develops,*” where each of these terms describes a type of relationship that exists between the “Organization” and “Document” objects. Similarly, a “Portfolio” object may have one or more “Document” objects that are “*members*” of that “Portfolio,” and a “Portfolio” may be associated with an “Organization” object that “*manages,*” “*uses,*” or “*develops*” the “Portfolio.”
6. **Publishing and managing content** – Anyone may access and search the Landscape for information. However, only registered users that are members of a Group or Subgroup may publish and manage content (e.g. add, update, delete, change access permissions, or content ownership) in the Landscape. Members may log into their Group/Subgroup, using their username and password, to add, update, or delete their content. They may also make relationships between their content and other user content, that is not restricted, and may also transfer content ownership and change content access permissions.
7. **Groups and Subgroups** - The Group and Subgroup functions of the Landscape provide a powerful set of capabilities that help users organize and manage the Landscape content. Groups and Subgroups enable organizations (or individuals) to establish their own "space" within HCSL for managing and controlling user membership and content in a Group, and in any of its Subgroup(s).

The Group/Sub-Group capability enables hierarchical Group and Subgroup structures to be established in the Landscape that can reflect the organizational structure of an organization using the Landscape. For example, a standards development organization (SDO) may have a hierarchical structure of committees, sub-committees, task forces, working groups, sub-working groups, etc., each with their respective members and documents (i.e. content) that are managed by different organizational components. Within this overall structure,

some content may be shared by all members of the organization, while other content may be restricted to the content owner, or limited to members of a subgroup, until such time that it is ready to be shared with others within or outside of the organization. The HCSL Group and Subgroup capability supports such requirements for organizing and managing group information and membership within an organization.

Each Group and Subgroup has its own Administrator who manages members, content, default content access permissions (e.g. who may access and view content), and Subgroups. Typically, HCSL content is "public" and viewable by all. However, there may be situations where a Group or Subgroup wants to keep its content "private," or only allow members of the Group or Subgroup to have access to its content; for example, while the information is still under development. Later, members of the Group or Subgroup may share their content publicly with other HCSL users.

3 Main Menu for Anonymous Users

The Main Menu for all non-registered, or “Anonymous,” users is shown in Figure 5. Each item on the Main Menu is briefly described below:

- Home – returns a user to the “Welcome” page
- Login/Logout – displays the Login or Logout page for use by Registered Users and Group/Subgroup Members
- Register – displays the user Registration page
- Search Content – displays submenus for searching HCSL content
- User Support – displays submenus for accessing support information
- Background – displays background information on the HCSL project
- Related Activities – displays submenus for other projects related to HCSL

Each menu and associated submenus are described further in the following sections.



Figure 5 Main Menus for Anonymous Users

4 Search and Browse Content

This section describes the “Search Content” menu, shown in Figure 5, which is used to search for information in the HCSL repository. When the “Search Content” menu is selected, six sub-menus appear, as listed below and shown in Figure 6:

Search Content Menu Selections

- Documents – search for documents.
- Organizations - search for organizations.
- Portfolios - search for portfolios.
- Relationships - search for content having a given relationship between them.
- Browse Groups – display and obtain information about Landscape Groups/Subgroups.
- Browse HCdomains – display the list of healthcare domains (enumerated list) and find documents or organizations associated with these domains.



Figure 6 Main Menu with Search Content Menu Expanded

When searching for Documents or Organizations, the Landscape provides two methods for finding content: the first method allows Boolean queries to be used in searching for content, and the second method provides for a pattern search using a text search-string to find content whose name or keywords contains the search-string. These two methods, and each of the sub-menus under the “Search Content” menu, are described in the following sections.

4.1 Search for Documents

By clicking on the “Documents” sub-menu (see Figure 6), the “Document Search” page will appear, as shown in Figure 7. This page provides two methods for searching for and finding documents: the first method allows Boolean queries to be used in searching for content; and the second method allows a text search-string to be used to find content having a name or keyword that contains the search-string. Each method is further described and illustrated in the following sections.

Document Search

[?](#)
HELP

This page allows searching the repository for Documents using the search fields below. Two different methods are available to search for Documents:

Method 1 - Search using data elements and values below: Using the default value of **ALL** for each data element results in **all** Document titles being displayed. Selecting specific values from each data element list, results in only those Documents containing those data values being displayed. By holding the <control> key down, multiple values for each data element list can be use for the search criteria.

Document Type: Document Status: Health Care Domains:

<ul style="list-style-type: none">AllAbstractAcknowledgement/ReceiptAnimationApplicationArt WorkArticleAudioBibliographyBill/InvoiceBill/List of MaterialsBookBrochure/PamphletBusiness CardBusiness DocumentCase StudyCertificateChartCharterCode List	AND	<ul style="list-style-type: none">AllApprovedApproved and publishedAt BallotDeprecatedDraftDraft standard for trial useFinal DraftIn-developmentNot Yet ApprovedPublishedRecommendationSupersededUnavailableUnder-reviewUnknownWithdrawn	AND	<ul style="list-style-type: none">AllAccounting/BillingAdministration/ManagementAlternative MedicineBilling (HIPAA)BiologyBiomedicineBiotechnologyCardiovascularChemicals (UMLS) <p>(<input type="radio"/> AND <input checked="" type="radio"/> OR)</p>
--	-----	--	-----	--

Search (method 1)

Method 2 - Search using a search string: A user specified search string is used to find all Documents whose Name or Keywords include the pattern of characters in the search string (search is case insensitive).

Enter a search string to search on

Document Name:

or on Document Keywords:

(Enter search text)

Search (method 2)

Figure 7 Document Search Page Showing Search Methods 1 and 2

4.1.1 Method 1 – Boolean Query

This Method allows a user to search for documents based on the content or values of selected data fields that have been indexed to facilitate searching by those values. For "Document" type objects, the HCSL indexes the data elements:

- Document Type
- Document Status
- HealthCare Domain

Each indexed element (i.e., search term) has a defined set of enumerated values that may be selected (from a drop down lists) and used to classify or characterize a new document when it is added to the Landscape or when it is updated. These indexed terms and values may then be combined and used in a Boolean query to search for content that contains the selected elements and values. The indexed elements and values are combined using the Boolean operators, "AND" or "OR," to form a Boolean expression that is used to query for selected content.

For example, referring to Figure 7, to find Documents in HCSL that are "published" standards related to healthcare "messaging," the user would select from the drop-down lists, the values:

- a) "Specification/standard" for "Document Type;"
- b) "Published" for "Document Status;" and,
- c) "Messaging" for "HealthCare Domain."

As previously shown in Figure 7, the default value for each of these indexed data elements or terms is "All." By using the default value of "All" for the various search terms, and selecting "Search," a list of all the Document names in the Landscape is displayed. Any item in this list can then be selected to view its data content.

Similarly, a user may select specific values for each term, and select whether the terms should be AND'd or OR'd together, to form a Boolean query. For example, a user may select "Standard," "Published," "Messaging" as values for "Document Type," "Document Status," and "HCDomain," respectively, to form the Boolean expression, "Standard AND Published AND Messaging," to search for all standards that are published and relate to messaging standards.

Note that for any search term, multiple values may be selected from a drop-down list and used in the query expression by holding the control key (Ctrl) down while making selections from a list. Thus, in the previous example, a user could find all published or draft standards relating to messaging by using the "Ctrl" key to select both "Draft" and "Published" from the list for "Document Status."

Note, that when multiple values for a search term are selected from a drop-down list, by default they form an implied "OR" expression among those values. Hence, in the previous example, selecting both "Draft" and "Published" from the list for "Document Status," will result in finding all HCSL Documents whose status is either "Draft" or

“Published.”

An exception to this rule exists for the search term "HealthCare Domains" where multiple values may be selected from the list and combined using either an "OR" or an "AND" condition in the query. Using the previous example again, all published or draft standards relating to messaging and/or health informatics may be found by selecting both "Messaging" and "Health Informatics" from the list of "HealthCare Domain" values, and then selecting either "AND" or "OR," beneath the list, to combine these terms and values, as required. This would allow searching for content having both healthcare domain values, or having either healthcare domain value, respectively.

4.1.1.1 Illustration of Method 1 Boolean Query Using the Default Value “ALL”

By using Method 1 and the default value of ALL for Document Type, Document Status, and HealthCare Domain, and the default condition “AND” between the indexed elements, as shown previously in Figure 7, a list of all document titles or names in the Landscape will be displayed, as shown in Figure 8 (partial list of documents shown).



Figure 8 Document Search Results List – (partial list)

By selecting the document title by clicking on it, the selected individual document with its data elements and values (content) will be displayed, as shown below in Figure 9. Note that only data elements containing actual values or content (i.e. non-empty elements) are displayed on the screen.

ADA TR 1016 - Electronic Signature Applications in Dentistry
Back

Relationship(s)	Browse Relationship(s)
Abstract	In the area of health information, both privacy and security are significant concerns. Privacy refers to the right of individuals to control access to personal information. Security refers to the tools put in place to enforce privacy and protect information systems. While these problems are not new, or unique to electronic systems, the potential for abuse and the visibility of the issue is raised as records move from paper to electronic forms of collection, storage and use. This paper provides the dentist information on electronic/digital signatures, their history and development, and how they apply to dentistry to provide authentication, non-repudiation, confidentiality and data integrity for electronic healthcare transactions, electronic mail and attachments.
Keywords	Electronic Signature, electronic/digital signatures, electronic information, privacy, security, non-repudiation, confidentiality, authentication, data integrity
Available at	ANSI/ADA
Document Type	Specification/standard
Document Status	Approved
Health Care Domain	Security/Privacy Dentistry
Authors/Editors	ANSI, ADAA
Intellectual Property	ANSI
Registration date	9/16/2004 16:17:13
Owner	trhodes
Group	Group informations

Figure 9 Contents of the Document Record “ADA TR 1016”

4.1.1.2 Illustration of Method 1 Boolean Query Using Specific Search-Term Values

Figure 10 shown below, illustrates a Boolean query using the search-terms and specific values of:

Document Type = “Abstract” AND
 Document Status = “Approved” AND
 HealthCare Domains = “Billing (HIPAA)”

Clicking on “Search (Method 1)” will result in a list of documents that are abstracts and approved documents with a healthcare domain of Billing (HIPPA). If there are no documents that satisfy this query, the result page will say “No Matching Content.”

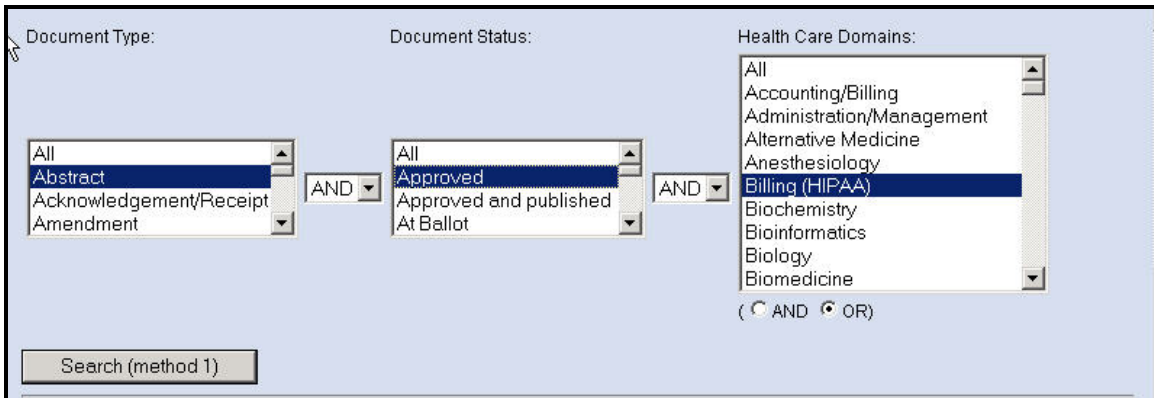

Figure 10 Boolean Document Query Using Specific Search-Term Values

The example shown below, Figure 11, illustrates a Boolean query using the search-terms and values of:

Document Type = “Abstract” OR
 Document Status = “Approved” or “Approved and published” AND
 HealthCare Domains = “Billing (HIPPA)”

This example illustrates the use of multiple values being selected for the search-term “Document Status.” Clicking on “Search (Method 1)” will result in a list of documents that are abstracts, or approved, or approved and published documents, with a healthcare domain of billing (HIPPA). If there are no documents that satisfy this query, the result page will say “No Matching Content.”

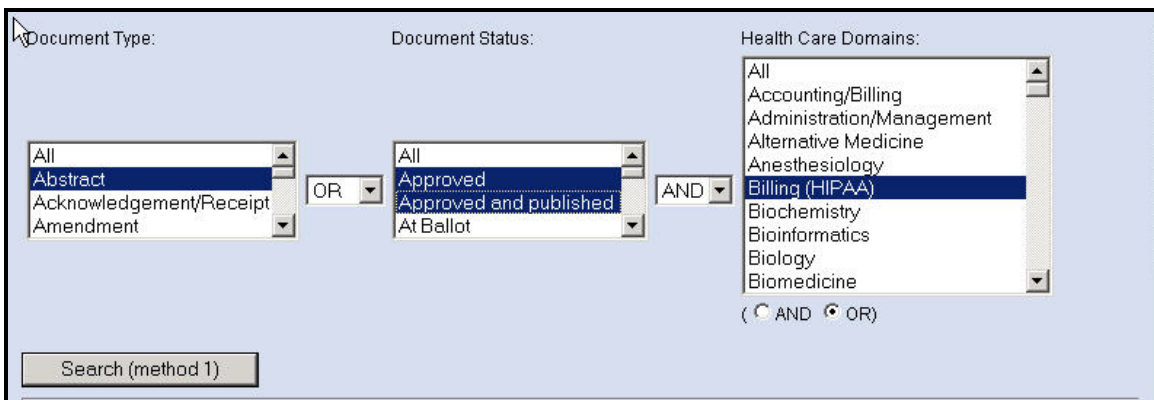

Figure 11 Boolean Document Query Using Multiple Search-Term Values

The example shown below illustrates a Boolean query using multiple values for the “Health Care Domain” data element that are combined in an “OR” expression. The screen shown below Figure 12, illustrates a Boolean query using the search-terms and values of:

Document Type = “Abstract” AND
 Document Status = “Approved” AND
 HealthCare Domains = “Accounting Billing” OR “Billing (HIPPA)”

Clicking on “Search (Method 1)” will result in a list of abstract and approved documents with healthcare domain of Billing (HIPAA) or Accounting/Billing. If there are no documents that satisfy this query, the result page will say “No Matching Content.”

Figure 12 Boolean Search Query Using OR with Multiple “HealthCare Domain” Values

4.1.2 Method 2 – Pattern Search Using a Search String

This Method allows a user to search for Documents using a string of characters as a pattern (i.e. search string) to find all documents whose Name or Keywords include the pattern of characters specified in the search string (Note that the pattern search is case insensitive and will match search string characters with either upper or lower case characters in the content name or keywords). For example, using the search string “HL7” in searching on the document name will display a list of all documents containing “HL7” in the Name data element.

4.1.2.1 Illustration of Method 2 Document Search Using A Search String

To search for documents that contain a particular text string either in the name or in the keyword fields of the document, a user would use Method 2, selecting either “Document Name” or “Document Keywords,” as shown in Figure 13, and enter the text-string to be matched against the document’s Name or Keywords.

Figure 13 Sample Document Query Using Method 2

Clicking on “Search (Method 2)” will result in listing documents where the string “smart card” can be found in the document name. If there no documents satisfy this search, the result page will say “No Matching Content.”

4.1.3 Finding All Documents with the Same Indexed Element and Value

Note that in the Document shown in Figure 14, the data elements “Document Type”, “Document Status”, and “HealthCare Domain(s)” have content values that are all displayed as active hyperlinks. Clicking a hyperlinked value associated with any of the three indexed elements will bring up a list of all other Documents that also include that particular element value. This provides an easy way to find all other Documents containing a specific value for any indexed term.

For example, in Figure 14, the document "HL7 Messaging" is associated with multiple healthcare domains, including Insurance, Accounting, and others, all of which appear as hyperlinks when viewing the "HL7 Messaging" document. By clicking on one of these hyperlinks, a list of the names of all other documents in the Landscape that are associated with that selected healthcare domain value will found and displayed. Document names in the displayed list can then be selected to view the information content of the Document.

HL7 Messaging	
Relationship(s)	Browse Relationship(s)
Abstract	<p>The HL7 Messaging standard is intended for exchanging clinical and administrative health care information (e.g. orders and observations, results reporting, patient administration, laboratory, control, etc). HL7 messaging is broadly divided between the HL7 2.x series of messaging standards (ANSI approved), and the newer, draft Version 3.0 messaging specification based on the HL7 Reference Information Model (RIM data model).</p> <p>HL7 V.2.3 introduced messages for document management, appointment servicing and resource scheduling, patient referrals, and messages to track patient goals.</p> <p>HL7 V.2.4 (ANSI/HL7 V2.4-2000 available at ANSI) introduced Conformance Query profiles, and added messages for laboratory automation, application management and personnel management.</p> <p>HL7 Version 2.5 Messaging Standard - Application Protocol for Electronic Data Exchange in Healthcare Environments - is the most widely implemented data exchange standard for healthcare information in the world. Version 2.5 introduces a number of new events, segments and messages, as expands on message control. Version 2.5 is more consistent and supports more functionality than any of the previous versions.</p> <p>HL7 Version 3, currently in draft form, uses an object-oriented development methodology and the RIM to create messages. The RIM provides an explicit representation of the semantic and lexical connections that exist between the information carried in the fields of HL7 messages that will enable a definite, consistent, and testable view of data that supports conformance testing and explicit data use and relationships. V3 has adopted ebXML and SOAP as message Transport Protocols, and use of XML and Webservices for encoding and processing messages.</p>
Keywords	healthcare, messaging, clinical messages, administrative messages, healthcare informatics, interoperability
Available at	http://www.hl7.org
Document Type	Specification/standard
Document Status	Published
Health Care Domain	Messaging Accounting/Billing Administration/Management Billing (HIPAA) Claims/Payment Clinical Encounters Health Informatics Health Information Insurance Laboratory Test/Result Patient Record Security/Privacy Specifications/Standards
Authors/Editors	HL7 Workgroup
Intellectual Property	HL7
Version	Versions 2.3, 2.3.1, 2.4, 2.5 (published and ANSI approved) and Version 3.0 (draft)
Registration date	11/20/2003 16:20:45
Owner	hcsi_admin
Group	Group information
Conformance Information	Conformance information
Conformance	Summary

Figure 14 Contents of Document “HL7 Messaging”

For example, in Figure 14, if the user clicks on “Insurance” in the HC Domain entry in the “HL7 Messaging” document, the HCSL system will retrieve and display the names of all other documents that include “Insurance” in the healthcare domain entry, as shown below in Figure 15.

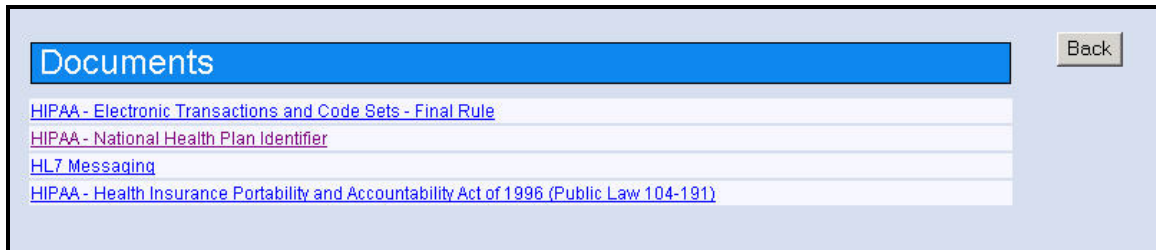

Figure 15 List of Documents having the HealthCare Domain “Insurance”

Finding documents by healthcare domains is described further in Section 4.6.

4.1.4 Browse a Document’s Relationships

Similar to finding documents by Healthcare Domain, as shown in the previous example, Figure 14, clicking the “Browse Relationship” link, will display any relationships that may exist between the current Document and any other Documents, Organizations, or Portfolios in the Landscape, as shown in Figure 16. If relationships exist with other content objects, the names of these objects will be displayed as hyperlinks, and can be clicked to view their content. Later, in Section 4.4, “Search for Content by Relationships,” a method for searching and finding content that have a given relationship between them will be described.

HL7 - Health Level Seven					
Relationships with Document(s)					
HL7 - Health Level Seven	develops	Arden Syntax for Medial Logic Systems v2.6	<input type="button" value="Update"/>	<input type="button" value="Delete"/>	
HL7 - Health Level Seven	is referenced by	AHRQ - Current Activities of Selected Healthcare Informatics Standards Organizations (aka "The Yellow Book")	<input type="button" value="Update"/>	<input type="button" value="Delete"/>	
HL7 - Health Level Seven	develops	HL7 RIM	<input type="button" value="Update"/>	<input type="button" value="Delete"/>	
HL7 - Health Level Seven	develops	HL7 CDA - Clinical Document Architecture	<input type="button" value="Update"/>	<input type="button" value="Delete"/>	
HL7 - Health Level Seven	develops	HL7 Messaging	<input type="button" value="Update"/>	<input type="button" value="Delete"/>	
Relationships with Portfolio(s)					
HL7 - Health Level Seven	manages	HL7 Portfolio	<input type="button" value="Update"/>	<input type="button" value="Delete"/>	
HL7 - Health Level Seven	manages	HL7 Version 3	<input type="button" value="Update"/>	<input type="button" value="Delete"/>	
Relationships with Organization(s)					
HL7 - Health Level Seven	is member of	HITSP - Healthcare Information Technology Standards Panel (ANSI)	<input type="button" value="Update"/>	<input type="button" value="Delete"/>	
HL7 - Health Level Seven	is member of	ANSI - American National Standards Institute	<input type="button" value="Update"/>	<input type="button" value="Delete"/>	
HL7 - Health Level Seven	is member of	HISB - Healthcare Informatics Standards Board (ANSI)	<input type="button" value="Update"/>	<input type="button" value="Delete"/>	
<input type="button" value="Back"/>					

Figure 16 Examples of Relationships for HL7 Organization

4.2 Search for Organizations

Searching for Organizations in the Landscape is similar to searching for Documents. In searching for Organizations, there are also two indexed date elements and two search methods: Boolean, and String search methods:

For "Organizations," HCSL indexes the data elements:

- Organization Type
- Health Care Domain

By clicking on the "Search Content" menu and then on "Organizations" submenu, as shown in Figure 6, the "Organization Search" page will appear, as shown in Figure 17.

Method 1 - Search using data elements and values below: Using the default value of **ALL** for each data element results in **all** Organization titles being displayed. Selecting specific values from each data element list, results in only those Organizations containing those data values being displayed. By holding the <control> key down, multiple values from each data element list can be used for the search criteria.

Organization Type: Health Care Domains:

All

- Academic
- Collaborative
- Consortia

AND

All

- Accounting/Billing
- Administration/Management
- Alternative Medicine
- Anesthesiology
- Billing (HIPAA)
- Biochemistry
- Bioinformatics
- Biology
- Biomedicine

(AND OR)

Search (method 1)

Method 2 - Search using a search string: A user specified search string is used to find all Organizations whose Name includes the pattern of characters in the search string (search is case insensitive).

Enter a search string to search on Organization Name:

Search (method 2)

Figure 17 Organization Query Using Search Method 1 and Default Value “ALL”

Each Organization search method is described below, followed by examples:

Method 1 – Boolean Query: The user can browse for “ALL” Organizations using the default value of “ALL” for the two indexed data elements “Organization” and “Health Care Domains,” as shown in Figure 17. Alternatively, the user may search for particular Organizations by selecting specific values from the list for “Organization Type” and for “Health Care Domains,” and combining these with “AND” or “OR” conditions, to form a Boolean query using the indexed elements and selected values.

Multiple values may also be selected for the indexed data elements in the query expression. To select multiple values, simply hold the control-key (Ctrl) down while making selections from a list. For example, the user can select one or more indexed values for “Organization Type”, select one or more indexed values for “Health Care Domains,” choose “AND” or “OR” as the condition between these two indexed terms, and then click the “Search (Method 1)” button. Note that if multiple values are selected from the “Health Care Domains” list, these values may further be combined in either an “OR” or “AND” expression for the query. Examples are illustrated in the following Sections.

Method 2 – Pattern Search Using a Search String: The user can search using a search string to find all Organizations whose name or keywords include the pattern of characters in the search string (search is case insensitive).

4.2.1 Illustration of Method 1 Boolean Query Using “ALL”

This example illustrates searching for Organizations using Method 1 and the default value of “ALL” for Organization Type and Health Care Domain, as shown previously in Figure 17. By clicking on “Search (method 1),” a list will be displayed of the names of all Organizations in the Landscape. To view a particular Organization, simply select the Organization name by clicking on it. The content for the selected organization will be displayed.

4.2.2 Illustration of Method 1 Boolean Queries Using Specific Values

By selecting specific values from the indexed terms “Organization Type” AND “Health Care Domain,” only those Organizations in the Landscape that contain those data values for these terms will be displayed. By holding the control-key (Ctrl) down, multiple values from each data element list can be used for the search criteria.

This example, as shown in Figure 18, illustrates a Boolean query using the search-terms and specific values of:

Organization Type = “Military” AND
Health Care Domains = “Biology”

By clicking on “Search (method 1),” a list of organizations that are both “Military” and associated with the “Health Care Domain” of “Biology” will be displayed. If there are no organizations that satisfy this query, the result page will say “No Matching Content.”

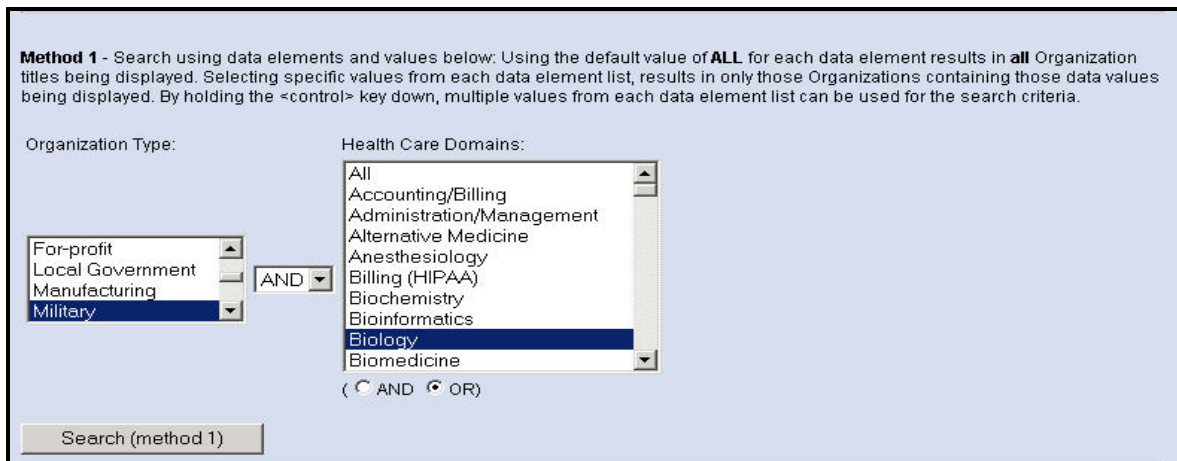

Figure 18 Organization Query Using Search Method 1 and Specific Index-Term Values

The next example, as shown in Figure 19, illustrates a Boolean query using the search-terms and specific values of:

Organization Type = “Military” OR
HealthCare Domains = “Biology”

Method 1 - Search using data elements and values below. Using the default value of **ALL** for each data element results in **all** Organization titles being displayed. Selecting specific values from each data element list, results in only those Organizations containing those data values being displayed. By holding the <control> key down, multiple values from each data element list can be used for the search criteria.

Organization Type:

Health Care Domains:

AND OR

Figure 19 Organization Query Using Search Method 1 and “OR” Between Indexed Terms

By clicking on “Search (method 1),” a list of organizations that are either “Military” or that have the “Health Care Domain” value of “Biology” will be displayed. If there are no organizations that satisfy this query, the result page will say “No Matching Content.”

4.2.3 Illustration of Method 2 Organization Search Using a Search String

Search Method 2 allows searching for an organization by name using a search string. As shown in Figure 20, the user can type in the text string (e.g., HL7) and click on “Search (method 2).”

Method 2 - Search using a search string: A user specified search string is used to find all Organizations whose Name includes the pattern of characters in the search string (search is case insensitive).

Enter a search string to search on Organization Name:

Figure 20 Organization Query Using Search Method 2

This will result in a list of organizations in the Landscape that include the text-string “HL7” in the organization name. If there are no organizations that satisfy this search, the result page will say “No Matching Content.”

4.2.4 Finding All Organizations with the Same Indexed Element and Value

When the content for an organization is displayed, the data elements “Browse Relationship(s)”, “Organization Type”, and “Health Care Domain(s)” have values that are shown as active hyperlinks. Similar to a Document, clicking on any of these links allows for quickly finding Relationships with other Landscape objects, or finding other Organizations that include the value selected for an indexed data element. Browsing organizations by healthcare domains is described further in Section 4.6.

4.2.5 Browse an Organization’s Relationships

Similar to browsing a Document’s relationships, as described previously in Section 4.1.4, an Organization’s relationships with other content may be viewed by clicking the “Browse Relationship” link in the Organization being displayed. If relationships with other content objects exist, the names of these objects will be displayed as hyperlinks that may be clicked to access and view the object’s content. Later, in Section 4.4, “Search for Content by Relationships,” a method for searching and finding content that has a given relationship between them will be described.

4.3 Search for Portfolios

The Portfolio object does not use any indexed data elements and only uses a search string to find Portfolios whose name contains the string, as shown in Figure 21. By clicking on the “Search Content” menu, and then the “Portfolios” submenu, as shown earlier in Figure 6, the “Portfolio Search” page will appear, as shown below:

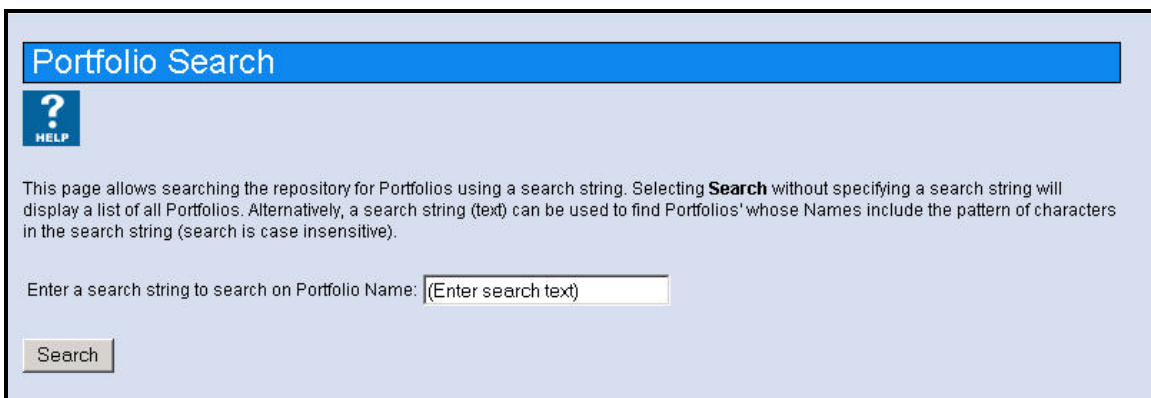

Figure 21 Portfolio Search Screen

If the “Search” button is selected without entering a search string, the search will return a list of **all** the Portfolio names in the Landscape repository. Selecting any item in this list will display the information content for the selected Portfolio.

4.3.1 Illustration of Portfolio Search Using a Search String

If the user wishes to search for a specific Portfolio (e.g., HL7), the user can type in the text string and click on Search, as shown in Figure 22 below.

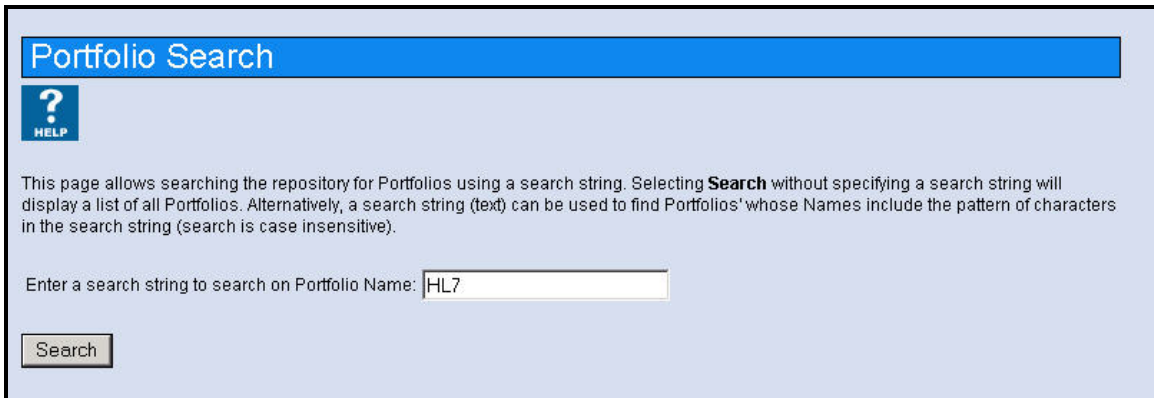

Figure 22 Sample Portfolio Search Using Search String of “HL7”

This search will find and display all Portfolios whose name contains the string “HL7,” as shown in Figure 23 (in this example only the HL7 Portfolio matches the search string):

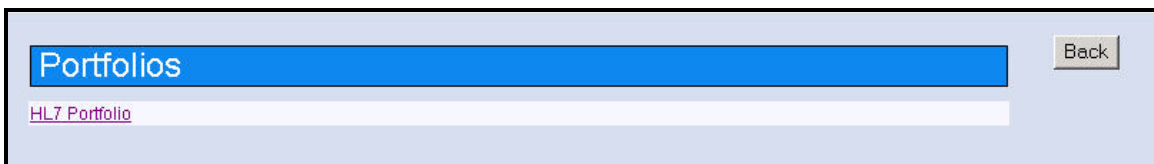

Figure 23 Results of Portfolio Search Using the Search String “HL7”

To view the contents of the HL7 Portfolio, simply click on the text “HL7 Portfolio” and the contents of the HL7 Portfolio entry will be shown, as in Figure 24 below:

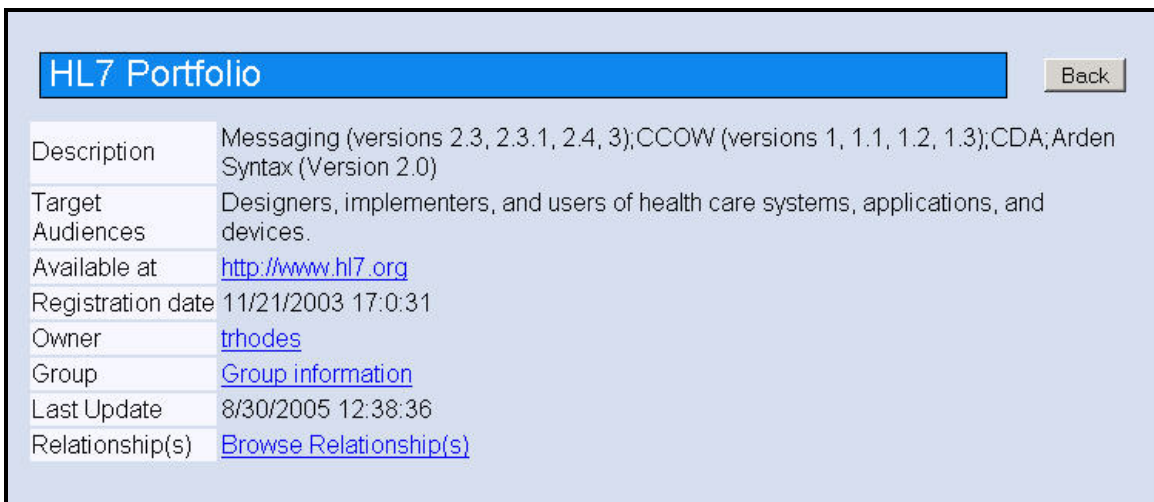

Figure 24 Content of “HL7” Portfolio

4.3.2 Browse a Portfolio’s Relationships

Similar to browsing relationships for Documents and Organizations, a Portfolio’s relationships with other content may be displayed by clicking the “Browse Relationships” link in the Portfolio being viewed. If relationships with other content objects exist, the

names of these objects will be displayed as hyperlinks that may be clicked to access and view the object's content. In Section 4.4, "Search for Content by Relationships," a method for searching and finding content that has a given relationship between them will be described.

4.4 Search for Content by Relationships

As described in Section 2, the HCSL supports searching based on Relationships that may exist between any two HCSL objects. Relationships can be defined among content objects in the Landscape, and Relationships can be used to search and find content having a given relationship between them. Different types of Relationships can be defined between Organization, Document, and Portfolio objects. Defining Relationships is described later in Section 6.4.1, "Adding a Relationship Between Content." This Section, however, describes how to use Relationships to search for content in the Landscape.

Relationships are defined among pairs of HCSL objects, as follows:

- Document-to-Document
- Document-to-Organization (or Organization-to-Document)
- Document-to-Portfolio (or Portfolio-to-Document)
- Organization-to-Organization
- Organization-to-Portfolio (or Portfolio-to-Organization)
- Portfolio-to-Portfolio

Any one of the HCSL object-types may be associated with another object-type through a named Relationship that describes a logical association that may exist between these objects. When searching by Relationships, the HCSL provides a drop-down list of Relationships that a user may select from to describe a relationship to be used in searching for HCSL content having that relationship between them.

For example, the named Relationship "*develops*" can be used to associate an Organization with Documents (e.g., standards, guidelines) that it develops, e.g. the organization HL7 *develops* HL7 Messaging standards. An Organization object may have a Relationship with one or more Document objects that include *develops*, *uses*, or *manages*, where each of these terms describe a type of Relationship between an Organization and a Document.

Similarly, the Relationship "*includes*" may be used between a Portfolio object and one or more Document objects to indicate Documents that are members of that Portfolio. Similarly, the Relationships, *develops*, *manages*, or *uses*, may be used between an Organization object and a Portfolio object to describe the type of Relationship between that Organization and its Portfolio.

A complete list of available Relationships in HCSL is shown in Section 6.4.3, Table 1.

A Relationship search begins by clicking on the "Search Content" menu and selecting "Relationships" on the Main Menu (see Figure 6), which displays the "Relationship Search" page, shown below in Figure 25:

Relationship Search

This page allows searching the repository using the Relationships between objects.

Select the type of Objects to use for a Relationship Search:

Source Object <u>Select one</u>	Target Object <u>Select one</u>
<input type="radio"/> Document	<input checked="" type="radio"/> Document
<input checked="" type="radio"/> Organization	<input type="radio"/> Organization
<input type="radio"/> Portfolio	<input type="radio"/> Portfolio

Figure 25 Selecting Object Types for a Relationship Search

Using the radio buttons, shown in Figure 25, a user selects a pair of object-types to be used in the relationship search. In this example, the Organization and Document type of objects have been selected. When the “Select” button is clicked, the “Relationship Search” screen appears, as shown in Figure 26.

Relationship Search

This page allows searching the repository using the Relationships between objects.

Source entity
Select one

ADA - American Dental Association

AHIMA - American Health Information Management Association

AHRQ - Agency for Healthcare Research and Quality

AMA - American Medical Association

ANA - American Nurses Association and American Nurses Foundation

Relationship
Select one or more

Any Relationship

adopts

develops

distributes

has association with

(hold control key down to select multiple relationships)

Target document(s)
Select one or more

Any

ADA Spec 1004 - Computer Software Performance for Dental Practice Software

ADA TR 1016 - Electronic Signature Applications in Dentistry

ADA TR 1019 - Technical Security Services and Application to Dentistry

AHRQ - Current Activities of Selected Healthcare Informatics Standards Organizations (aka "The Yellow Book")

(hold control key down to select multiple target objects)

Figure 26 Selecting Source and Target Objects and Relationship(s)

From this screen, a user selects: a) a specific instance of an Organization from the “Source entity” field, b) the specific type of relationship(s) from the “Relationship” field, and c) the specific instance(s) of a Document record from the “Target document” field. In the above example, the selections are: **ADA - American Dental Association** as the Organization, **Adopts** as the Relationship, and **Any Document** as the “Target document.” Clicking the “Search” Button initiates and displays the search results. Clicking the “Clear” Button resets the selected choices.

Figure 27 shows the display when the Relationship specified between the objects is not found. Figure 28 shows the display when the specified Relationship exists between the objects and has been found.

A hyperlink, shown in both Figures below, is also provided to view all Relationships that may exist for the selected “Source entity.” In this example, the **ADA** Organization is the “Source entity,” and clicking the hyperlink would allow a user to view all Relationships between the **ADA** Organization and any other objects, if they exist.

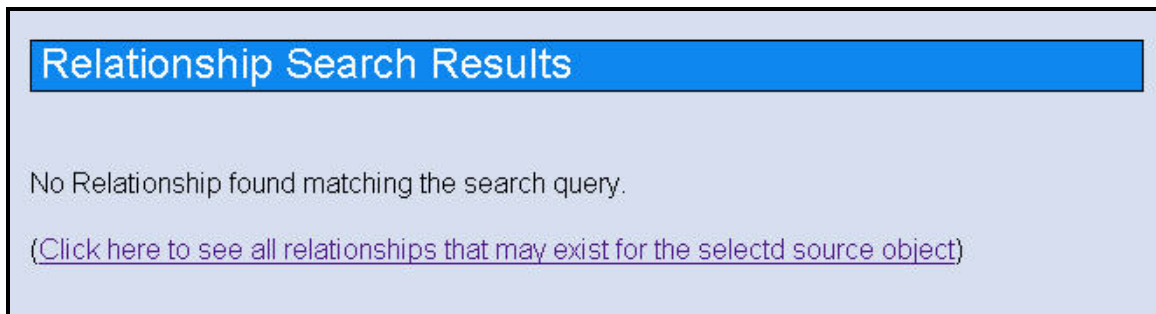

Figure 27 Search Results for “Relationship Not Found”

When Relationships exists, they are displayed as shown in Figure 28. In this example, the screen displays the results of a Relationship search in which the selected Relationship was *develops* (viz. ADA *develops* Any Document).

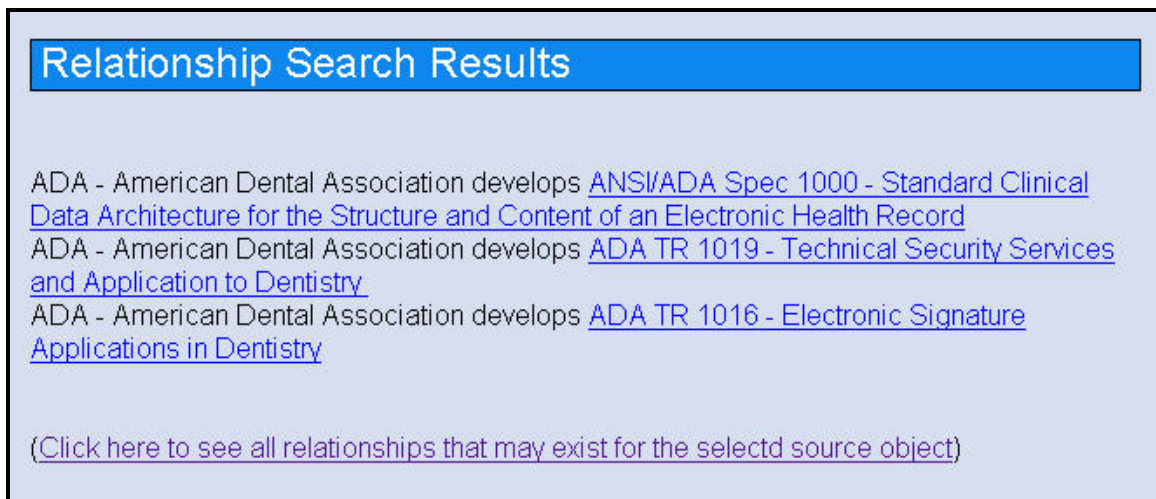

Figure 28 Search Results for “Relationship Found”

On this screen, the user may click on any of the Documents (hyperlinks) that ADA develops to view the contents of those Documents.

Similarly, Relationship searches may be done for other pairs of object-types and relationships to find content having those Relationships between them. For example, a Relationship search may be done for “Any Organization” that *Adopts* “Any Portfolio” to view all Organizations that have adopted a Portfolio.

4.5 Browse Groups and Subgroups

A user may view a list of the all Groups and Subgroups that are currently defined in the Landscape by selecting the “Search Content” menu on the Main Menu, Figure 6, and the “Browse Groups” sub-menu. This will display a list of Landscape Groups, as illustrated in Figure 29 below:

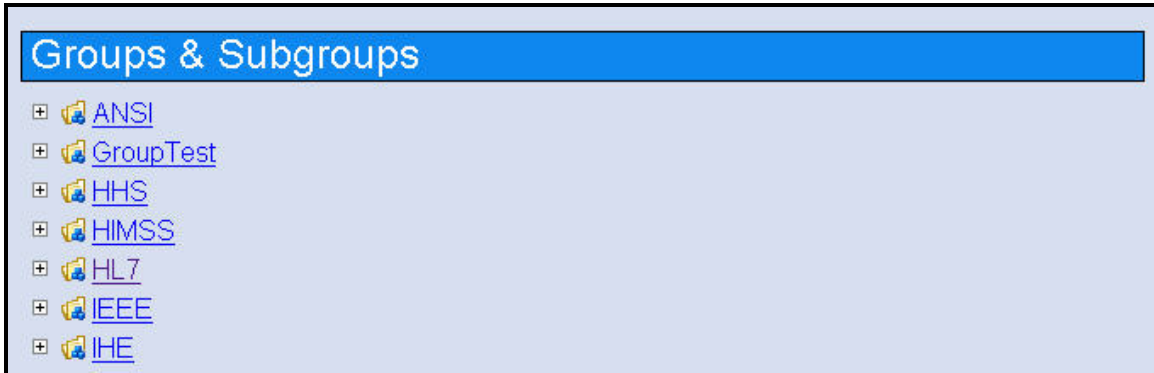

Figure 29 List of Landscape Groups (Partial)

The names of the Groups are displayed in a “tree-structure” that can be expanded or closed by clicking on the “+” sign for any item in the list. For example, clicking on the “+” sign for the “HHS” Group will reveal any of its Subgroups, as shown in Figure 30. Clicking the “+” sign for any Subgroup (e.g. ONC) will reveal any of its Sub-Subgroups, and so on.



Figure 30 Expanded Lists of the HHS Group and Subgroups

By clicking on the Group or Subgroup name (hyperlink), further information about that Group or Subgroup will be displayed, e.g. Group Administrator, Members, etc., as shown in Figure 31 for the “NIST” Group in the Landscape.

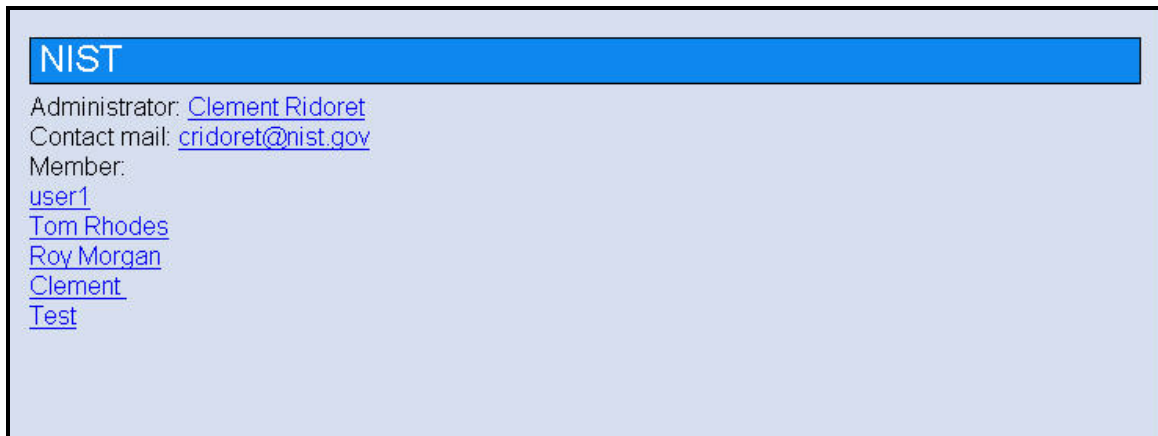

The screenshot shows a blue header bar with the text "NIST". Below the header, the following information is displayed: Administrator: [Clement Ridoret](#); Contact mail: cridoret@nist.gov; Member: [user1](#), [Tom Rhodes](#), [Roy Morgan](#), [Clement](#), and [Test](#).

Figure 31 Group Information Display – NIST

By clicking on a persons name (hyperlink), a user can view contact information for Group members and see a list of content entered or submitted (i.e. “owned”) by members of the Group or Subgroup, as shown in Figure 32.

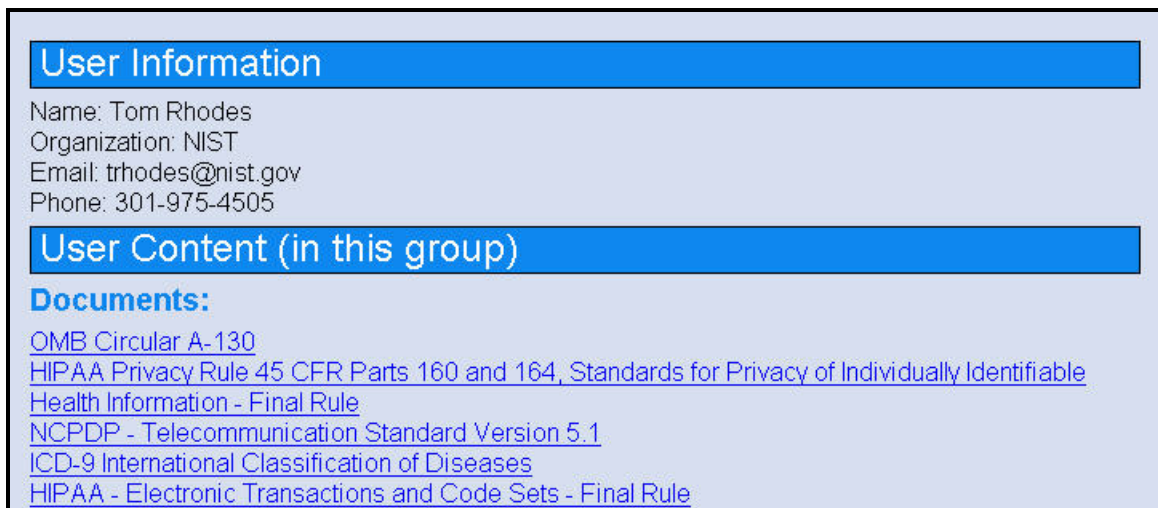

The screenshot shows a blue header bar with the text "User Information". Below the header, the following information is displayed: Name: Tom Rhodes; Organization: NIST; Email: trhodes@nist.gov; Phone: 301-975-4505. Below this is another blue header bar with the text "User Content (in this group)". Underneath, the section "Documents:" is followed by a list of hyperlinks: [OMB Circular A-130](#), [HIPAA Privacy Rule 45 CFR Parts 160 and 164, Standards for Privacy of Individually Identifiable Health Information - Final Rule](#), [NCPDP - Telecommunication Standard Version 5.1](#), [ICD-9 International Classification of Diseases](#), and [HIPAA - Electronic Transactions and Code Sets - Final Rule](#).

Figure 32 Information Display for a Group/Subgroup Member

Similarly, clicking on any content names (hyperlinks) shown in the display will display the information content for that object.

4.6 Browse HealthCare Domains

In the Landscape, Documents and Organizations entered into the Landscape may be associated or classified by various “HealthCare Domains” that are listed in the Landscape. When either a Document or Organization is first added to, or updated in the

Landscape, one or more values for the “HealthCare Domain” data element may be selected from a drop-down list to associate or classify that object with those values. As was explained previously in Sections 4.1.3 and 4.2.4, when viewing the content for a Document or Organization object a user may click on any healthcare domain value displayed as a hyperlink to quickly get a list of other objects of that type that include the same healthcare domain value.

Alternatively, a user may select the “Search Content” menu and the “Browse HealthCare Domains” sub-menu, as shown in Figure 6, to browse the entire list of HealthCare Domain values, as shown in Figure 33 below:

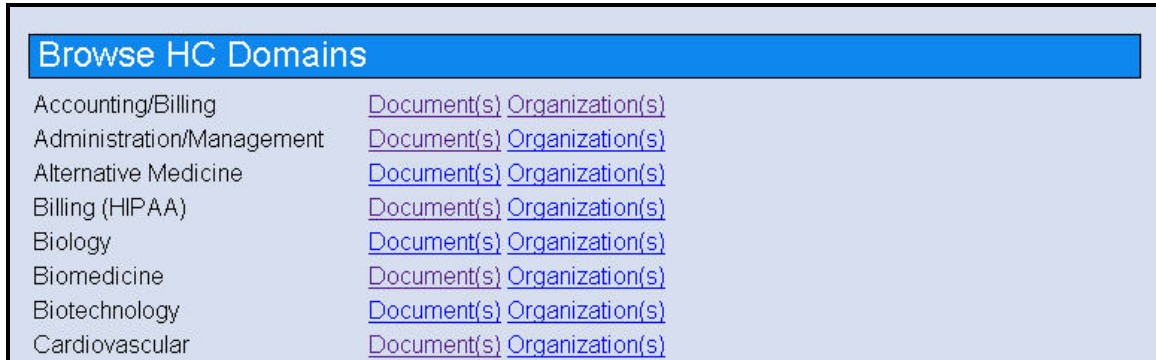

Browse HC Domains	
Accounting/Billing	Document(s) Organization(s)
Administration/Management	Document(s) Organization(s)
Alternative Medicine	Document(s) Organization(s)
Billing (HIPAA)	Document(s) Organization(s)
Biology	Document(s) Organization(s)
Biomedicine	Document(s) Organization(s)
Biotechnology	Document(s) Organization(s)
Cardiovascular	Document(s) Organization(s)

Figure 33 List of HealthCare Domains (partial listing)

By clicking on a “Document(s)” or “Organization(s)” hyperlink, as shown in Figure 33, a listing of all Documents or Organizations in the Landscape that are associated with the corresponding healthcare domain (value) will be displayed. Shown in Figure 34, are the results for clicking the “Document(s)” link for the “Accounting/Billing” healthcare domain.

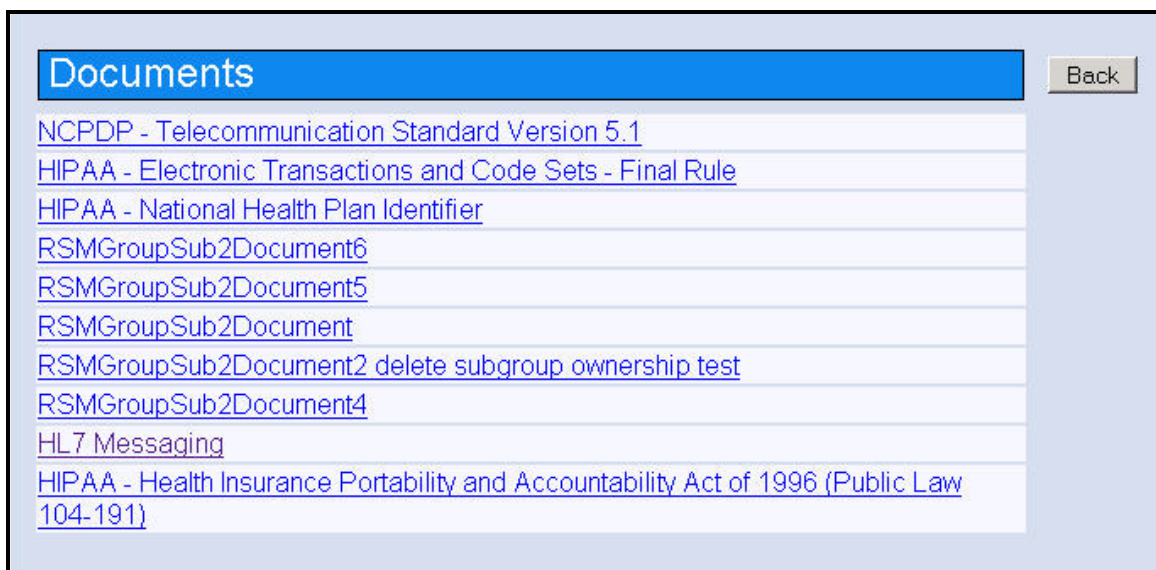

Documents	Back
NCPDP - Telecommunication Standard Version 5.1	
HIPAA - Electronic Transactions and Code Sets - Final Rule	
HIPAA - National Health Plan Identifier	
RSMGroupSub2Document6	
RSMGroupSub2Document5	
RSMGroupSub2Document	
RSMGroupSub2Document2 delete subgroup ownership test	
RSMGroupSub2Document4	
HL7 Messaging	
HIPAA - Health Insurance Portability and Accountability Act of 1996 (Public Law 104-191)	

Figure 34 List of Documents with the HC Domain “Accounting/Billing”

Similarly, clicking the “Organizations(s)” link, associated with the HealthCare Domain “Accounting/Billing,” displays a list of all Organizations in the Landscape associated with this domain, as shown in Figure 35.



Figure 35 List of Organizations with the HC Domain “Accounting/Billing”

5 Users, Roles, Registration, Groups and Subgroups

A Landscape user is a person who uses the Landscape to either browse/search for content, add, update, delete and manage content, or manage Groups (or Subgroups), members, and content. The Landscape defines seven primary types of users, each having specific capabilities and privileges associated with the user role. These are described further in the following sections:

5.1 Landscape User Types

Within the Landscape, there are several classes or types of users, each with associated roles and privileges. The different types of Landscape users are:

- **Anonymous User (AU)** - any non-registered user of the Landscape.
- **Registered User (RU)** - a user who has registered with the Landscape.
- **Group Member (GM)** – a registered user who has joined a Group.
- **Group Administrator (GA)** - a Group member who has been designated by the System Administrator to manage a Group.
- **Subgroup Member (SGM)** – a Group member who has joined a Subgroup of the Group.
- **Subgroup Administrator (SGA)** - a Group member who has been designated by the Group Administrator to manage a Subgroup.
- **System Administrator (SA)** - a person with overall responsibility for managing the Landscape system.

Each of these Landscape user types is discussed further in the following Sections, together with the concept of Groups and Subgroups, which are related to the users who are members or administrators of these Groups and Subgroups.

5.2 Landscape Groups and Subgroups

The Landscape supports creation of user Groups and Subgroups, which is described in more detail in Section 7, “Establishing and Managing Groups and Subgroups.” Briefly, however, Groups are identified by a Group name and have their own members, one of whom may be designated as the Group Administrator. Each Group may have its own Group content (i.e., information) that is managed and controlled by the Group members. Each Group may be further organized into Subgroups, which in turn may have their own Subgroups (i.e., sub-subgroups), and so on, reflecting a hierarchical organizational structure. The hierarchy of a Group may extend many levels deep. In practice, a typical organization is likely to only extend from three (3) to five (5) levels deep. However, some organizations may have a more extensive sub-structure; e.g., committee, subcommittee, working group, sub-working group, task group, subtask group, and special interest group. The Landscape can support simple to more complex organizational structures.

5.2.1 Types of Membership in Groups and Subgroups

Within a Group and Subgroup, there are different types of user membership designations, each having specific roles and privileges. The user membership types are described below:

- A Group Member is a Registered User that is a member of one or more Groups.
- A Group Administrator is a Group Member authorized by the System Administrator to be the Administrator of the Group.
- A Subgroup Member is a Group Member who has requested to join a Sub-Group, and who has been approved by the Subgroup Administrator.
- A Subgroup Administrator is a Member of a Group and Subgroup who is authorized by the Group Administrator, or Systems Administrator, to be the Administrator of the Subgroup.

Since Subgroups may be established under Subgroups, as well as under Groups, the concept of Subgroup member types also extends to members of subordinate Subgroups, as required.

5.3 User Roles and Privileges

Each type of user can be thought of as having a “role” in the Landscape with associated privileges regarding administrative or content management functions they can perform that affect Landscape content, users, or groups. These roles and privileges are described below for each type of user (Note, see Appendix D - User Roles and Privileges” for further information).

5.3.1 System Administrator (SA)

The System Administrator (i.e. Landscape Administrator or “Root” Administrator) is responsible for overall management, operation, maintenance, and use of the Landscape

system to ensure the Landscape performs satisfactorily. This includes management of the hardware, software, data, users, groups, and group/subgroup administrators.

5.3.2 Anonymous User (AU)

An Anonymous User may browse and view unrestricted or public content in the Landscape. They do not have a user name and password, and cannot login to the Landscape. An Anonymous User may register to become a Registered User of the Landscape.

5.3.3 Registered User (RU)

An Anonymous User may register with the Landscape to become a Registered User by completing and submitting a Landscape Registration Form online (see Section 5.4). Registration includes setting a username and password, and providing contact information. Upon successful submission of the Registration form, the user is automatically registered and may immediately login to the Landscape with their login name and password. By default, a Registered User is automatically made a member of the “**Guest**” Group, and can only login to the Guest Group (see Section 5.5.1).

Upon logging into the Guest Group, a “Guest” User can browse and search the Landscape, similar to an Anonymous User, but may not add or manage content in the Landscape. However, “Guest” Users are presented with a new Menu item, called “Member Area,” that provides additional menu selections that allow them to a) change personal information (“My Settings”), b) join other Groups (“Join a Group”), or c) establish a new Group (“Create a Group”). These features are described further in Sections 5.6 and 7.1, respectively.

A Registered User can request to join one or more Groups or Subgroups. When a Group or System Administrator approves a user request to join their Group or Subgroup, a Registered User becomes a Group Member with associated privileges. These features are described further in Section 5.6 and 5.7.

A Registered User may also create a new Group by selecting the “Create a Group” selection under the “Member Area” menu. This feature is described in Section 7.1.

5.3.4 Group Member (GM)

A Group Member is a Registered User of the Landscape who is an approved member of one or more Groups, other than the Guest Group. A Group Member may login to a Group with a unique username and a password, where they may change their password, add and manage their content in the Group, and make content relationships. A Group Member may modify and delete any content and relationships that they have submitted (i.e. content they “own”). A Group Member may change the default content permissions, as set by the Group Administrator, for viewing and modifying content that they submitted, and may transfer “ownership” of their content to another Group member. A Group Member may request to join Subgroups within their Group, or other Groups in the Landscape. A Group Member may also remove themselves from a Group.

5.3.5 Group Administrator (GA)

A Group Administrator is a Group Member, who authorizes or refuses Group membership requests, sets the default content access-control permissions for Group Members, adds or removes Subgroups, and authorizes Subgroup Administrators (see Section 7). The System Administrator designates the Registered User who established the Group to be the initial Group Administrator. The Group Administrator can only be removed and/or replaced by another Group Member, by the System Administrator.

5.3.6 Subgroup Member (SGM)

A Subgroup Member is a member of a parent Group who has requested to join a Subgroup within a Group, and who has been approved as a Subgroup Member by the Subgroup Administrator. In general, a Subgroup Member's privileges are similar to those of a Group Member, but within their Subgroup. Since Subgroups may be divided into further "sub-subgroups," and so on in a descending hierarchical fashion, the subgroup membership process may be repeated for each subordinate subgroup, as group and subgroup members request to join lower-level subgroups.

5.3.7 Subgroup Administrator (SGA)

A Subgroup Administrator is a member of a parent Group or Subgroup who has been designated by the Group or Subgroup Administrator to be the Administrator of a subordinate Subgroup. In general, the Administrators of Subgroups have the same responsibilities and privileges for their Subgroups, as do the Administrators for their parent Groups or Subgroups. This allows a hierarchical structure of subgroups to be established, each having their own Administrators who are drawn from a parent group or subgroup. The Subgroup Administrator can be removed and/or replaced by another Group/Subgroup Member, by the Group Administrator.

5.4 User Registration

Landscape registration allows an Anonymous User to set up an account within HCSL and select a unique username and password for identification and login purposes, as described below. A user may register with the Landscape by selecting the "Register" menu selection from the Main Menu (see Figure 5), and by completing and submitting the "User Registration" form, shown in Figure 36.

HCSL Registration

Users are not required to register with HCSL to search the HCSL for information. All users may search HCSL information as "guests" without needing to first register and Login.

To register with the HCSL, complete and submit this form:

Login Name: (Username)

Password:

Full Name:

Organization:

Phone:

Email:

* Note that only users who have registered with HCSL, and who are members of an HCSL Group, or any of its Subgroups, may add, update, or delete information within that Group or the Subgroup(s) to which they belong. A registered user may join one or more Groups, and only Group members may join one or more Subgroups within a Group. Directions for joining a Group and Subgroup are described below:

To join and login to a Group:

- First register a Username and Password with HCSL *(the HCSL Administrator will confirm the registration by email)*.
- When confirmed, login to HCSL with your Username and Password.
- Select the **"Join a Group"** selection under the **"Member Area"** menu item.
- Select a Group to join, from the list of displayed HCSL Groups, and **"Submit"** the request *(the request will be sent by email to the Group Administrator, who accepts or refuses the request, and notifies the user by email)*.
- When accepted, the user can login to HCSL, and their Group, for adding and managing their content.*

To join and login to a Subgroup:

- First join a Group, as described above.
- Login to HCSL and your Group.
- Select the **"Join a Group"** selection under the **"Member Area"** menu item.
- Select a Subgroup to join, from the list of displayed Subgroups, and **"Submit"** the request *(the request will be sent by email to the Subgroup Administrator, who accepts or refuses the request, and notifies the user by email)*.
- When accepted, the user can login to HCSL, and their Subgroup, for adding and managing their content.*

* Note that a member of a Group or Subgroup may only modify or delete information which they have submitted, or Group/Subgroup information for which they have been given permission to modify or delete by the content owner or Group/Subgroup Administrator.

Figure 36 User Registration Form

5.4.1 Separate HCSL User Accounts

Note that a user may register in the Landscape more than once and set up separate accounts, each with a different username and password. Each username, however, must be unique within HCSL. For example, a user may set up separate accounts for each Group they belong to as a member, and use a different username and password when logging into different Groups. Each user account is treated as a unique, separate user in the Landscape for the purposes of log in, Group membership, and content control. For example, a user with two separate accounts (i.e. different usernames) that are used for logging into separate Groups can only manage their content within the Group that they logged into using one of the user accounts. Alternatively, a user may use a single username and password (i.e. single login account) for all Groups that they belong to as a member.

5.5 Registered User Login to HCSL

Once a user has registered with HCSL, they are automatically placed within the Guest Group and may log in to HCSL using their username and password. As described earlier in Section 5.3.3, a "Guest" User (i.e. a member of the Guest Group) may search the

Landscape for content, request to join other Groups within the Landscape, or request that a new Group be established. Guest Users, however, may not add or manage content within the Guest Group (*Note, a member of an HCSL Group, other than the “Guest” Group, may add, update, or delete information content within those Group, or Subgroups, to which they belong*). To add and manage content, a Registered User in the Guest Group must first join or create another Group. A Registered User may also join one or more Groups, and Group members may join one or more Subgroups within a Group. These features are discussed further in Sections 5.6 and 5.7.

The “Login/Logout” button on the Main Menu (see Figure 37) enables a Registered User (Guest or Group member) to login and logout of a Group or Subgroup to which they belong as a member. The following sections describe the Login process for logging into the Guest Group, or into other Landscape Groups and Subgroups.

5.5.1 Login to Guest Group

A Registered User can select the “Login/Logout” menu selection, shown previously in Figure 5, and enter their Username and Password to login using the form shown in Figure 37. By default, a Registered User is automatically a member of the Guest Group, and can only login to the Guest Group, as shown in Figure 38. When the “Submit” button is clicked, the user will be logged in to the Guest Group.

Login

All users may search and browse HCSL information as "Guests" without needing to login below. Simply select "**Search Content**" from the menu on the left to begin searching HCSL information. Registered users who are members of a Group/Subgroup, who wish to add, modify, or delete information to a Group/Subgroup, may login below and then select a Group or Subgroup from the following page.

*Note that a Group or Subgroup **must** be selected before continuing, in order to complete the **Login** process*

Login:

Password:

[Forgot your password ?](#)

Figure 37 Login Screen for Registered Users

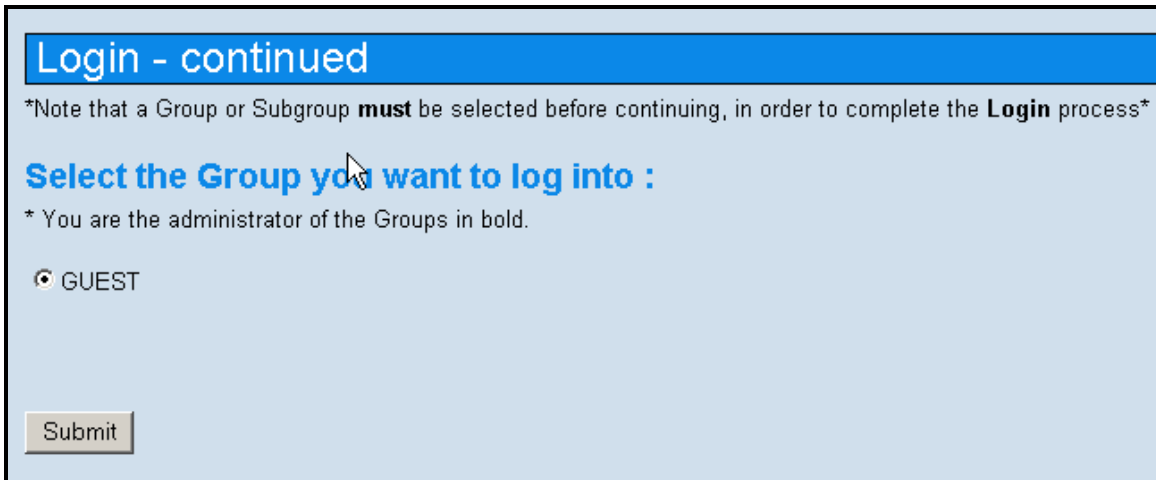

Figure 38 Guest Group Login Screen for Registered User

Note that if a user forgets their password, they may click the “Forgot your password?” link shown in Figure 37, and a new password will be emailed to them.

Once logged in, the HCSL provides additional menu items for Guest Users, as shown in Figure 39, which includes the additional “Member Area” menu selections, cited previously for Registered Users in Section 5.3.3. These menu selections will be described further in the following sections.

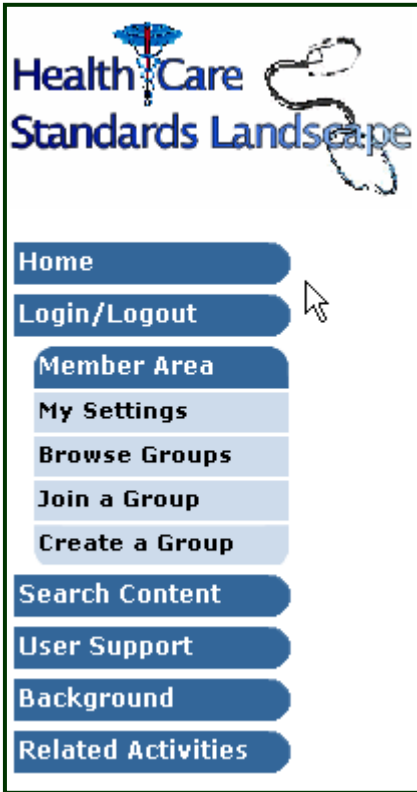
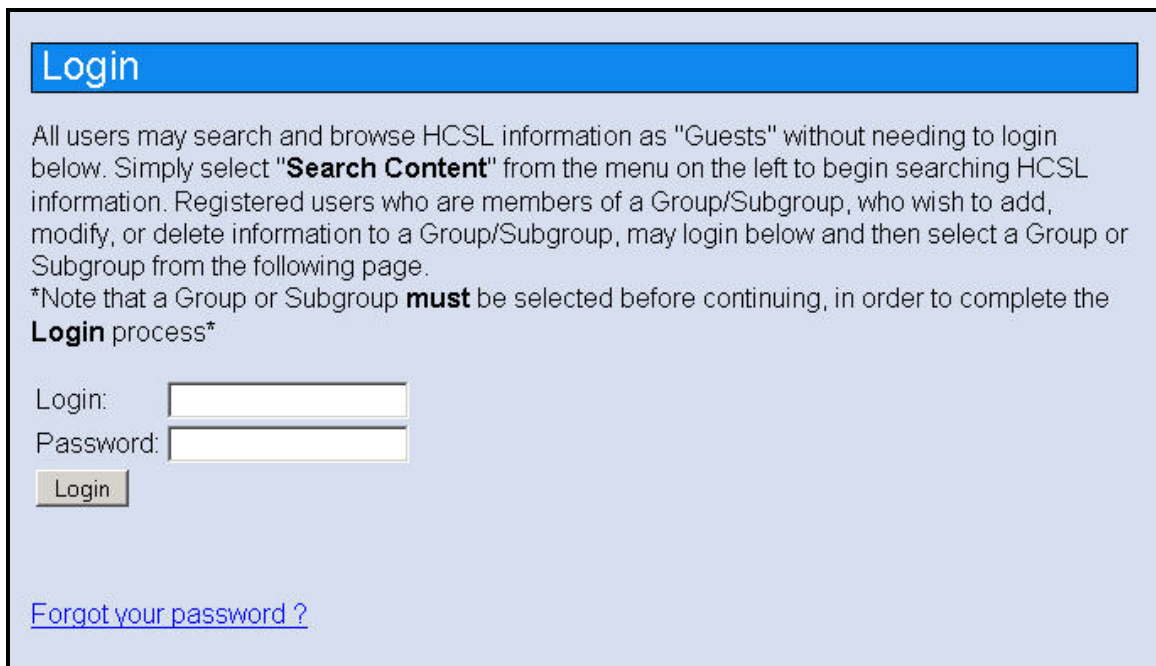

Figure 39 Main Menus Showing “Member Area” Menu Selections for Registered “Guest” Users.

5.5.2 Login to a Group or Subgroup

The “Login/Logout” menu on the main Menu (see Figure 39) enables a Registered User (Guest User) or Group Member to login and logout of a Group or Subgroup to which they belong (e.g. Guest Group for a Guest User). The login/logout process for any Group is similar to that for the Guest Group, described above in Section 5.5.1.

To Login to a Group or Subgroup, a user selects the “Login/Logout” menu on the Main Menu, enters their username and password, and then selects one of the displayed Groups or Subgroups that they belong to as a member. Only Groups and Subgroups that a user is a member of will be displayed in the list of Groups and Subgroups. The user **must** select a Group or Subgroup in order to complete the log in process. If the user is a member of more than one Group, he/she may log in to a Group and then switch to another Group later (see Section 6.1.4). Figure 40 and Figure 41 show the two display forms used to log into an HCSL Group or Subgroup.



The screenshot shows a web page titled "Login". The page content includes the following text:

All users may search and browse HCSL information as "Guests" without needing to login below. Simply select "**Search Content**" from the menu on the left to begin searching HCSL information. Registered users who are members of a Group/Subgroup, who wish to add, modify, or delete information to a Group/Subgroup, may login below and then select a Group or Subgroup from the following page.

*Note that a Group or Subgroup **must** be selected before continuing, in order to complete the **Login** process*

Login:

Password:

[Forgot your password ?](#)

Figure 40 Login Screen to Enter Username and Password

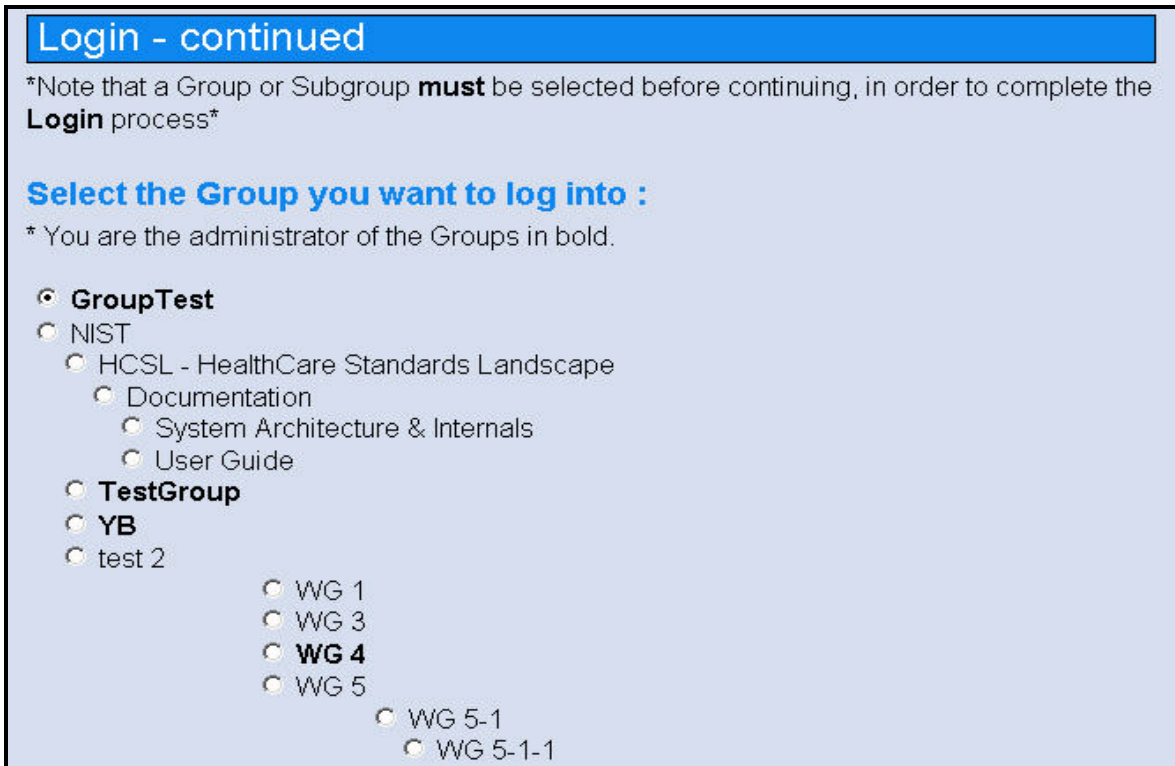

Figure 41 Select Group or Subgroup Screen – Login continued

In the example shown in Figure 41, a user is shown a list of Groups and Subgroups that they are members of for selection. The user can select and log into any of these Groups or Subgroups. Note, that Groups and their Subgroups are displayed as an indented hierarchy. Groups and Subgroups, for which the user is an Administrator, are displayed in bold text, while those Groups or Subgroups, in which the user is only a member, are displayed as normal text.

After selecting a Group or Subgroup and clicking the “Submit” button (not shown in the figure), the user will be logged into the selected Group or Subgroup and presented with a new Main Menu containing additional options for adding and managing content, and other capabilities, as shown in Figure 42. The Main Menu features for Group/Subgroup members will be discussed further in Section 6.



Figure 42 Main Menu Selections for a Group/Subgroup Member

5.5.3 Log Out of a Group or Subgroup

The Logout screen, Figure 43, is simply a “Logout” button. Clicking it will log the user out of a Group or Subgroup, with a brief message that Logout has been completed. The user will then be returned to the “Welcome” screen.



Figure 43 Logout

5.6 Joining an HCSL Group

To join an HCSL Group, a Registered User:

- Logs into the Guest Group, or another Group or Subgroup, to which they belong, and selects the "Join a Group" selection under the "Member Area" menu item. This will display a list of all Landscape Groups, as shown in Figure 44.
- From the displayed list of Groups, the user selects a Group to join and clicks "Submit."
- The user will receive a confirmation message, as shown in Figure 45, indicating that the request has been sent by email to the Group (or Subgroup) Administrator.

- The request is automatically be sent by email to the Group Administrator, who accepts or refuses the request, and subsequently notifies the user by email.
- When accepted, the user can login to HCSL and the Group, to add and manage their information content within the Group.



Figure 44 Selecting an HCSL Group to Join

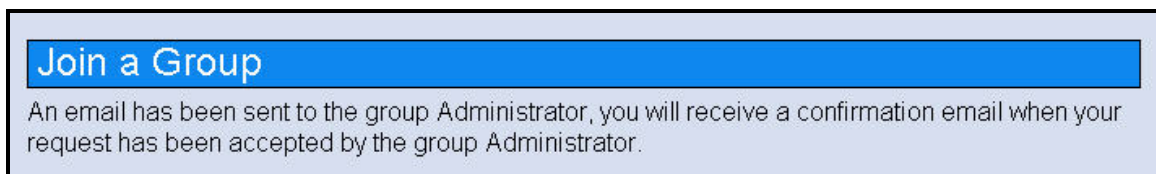

Figure 45 Join a Group – Request Sent Notification Message

5.7 Joining an HCSL Subgroup

A Registered User, who is a member of a Group, or Subgroup, may request to join any Subgroups that exist under a Group or Subgroup of which they are members. The process for doing this is described below, first for joining a Subgroup under a Group, and

then for joining a Subgroup under a Subgroup, of which they are members. Leaving a Group/Subgroup is described later in Section 6.1.2.1.

5.7.1 Joining a Subgroup within a Group

A member of a Group may request to join any of its Subgroups, as follows:

- First join a Group, as described above.
- Login to any Group for which you are a member, as described previously.
- Select the "Join a Group" selection under the "Member Area" menu item.
- If the Group has Subgroups, these will be displayed for the user to select.
- Select a Subgroup to join, and "Submit" the request. (The request will be sent by email to the Subgroup Administrator, who accepts or refuses the request, and notifies the user by email). When the request is submitted, the user will receive a confirmation alert, as shown in Figure 45, indicating that the request has been sent by email to the Subgroup Administrator.
- When accepted, the user can login to HCSL and the Subgroup, to add and manage their content within that Subgroup.

Figure 46 below, is an example of available Landscape Subgroups (and other Groups) that a member of the "ANSI" Group may join. In this example, the "ANSI" Group has three Subgroups under it that the user may request to join by selecting a Subgroup and clicking the "Submit" button (not shown in the figure).



Figure 46 Join a Subgroup Display

5.7.2 Joining a Subgroup within a Subgroup

Joining a Subgroup under a parent Subgroup is similar to joining a Subgroup under a Group, as was described above. The steps are as follows:

- First join a Subgroup, as described above.
- Login to any Subgroup for which you are a member, as described previously.
- Select the "Join a Group" selection under the "Member Area" menu item.
- If the Subgroup has further Subgroups, these will be displayed for the user to select. Select a Subgroup to join, and "Submit" the request (the request will be sent by email to the Subgroup Administrator, who accepts or refuses the request, and notifies the user by email).
- When accepted, a user can login to HCSL and the Subgroup for adding and managing their content within that Subgroup. *Note that a user can login directly to a Subgroup; they do not need to first log into a parent Group or Subgroup.*

5.7.3 Create a Group

The “**Create a Group**” capability is discussed further in Sections 6.1.7 and 7.1.

6 Menus for Group and Subgroup Members

When a Registered User logs in to a Group (except for the Guest Group) or a Subgroup, a new Main Menu is displayed with additional capabilities under the menus “Member Area” and “Add Content,” as shown in Figure 47. These new capabilities are described in the following Sections.

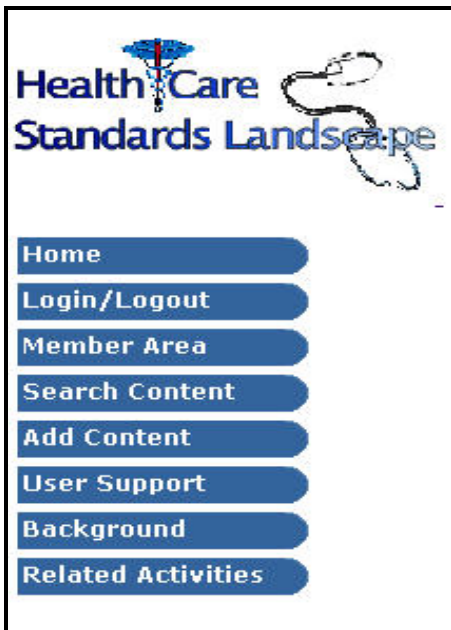

Figure 47 Main Menu Selections for a Group/Subgroup Member

6.1 Member Area Menu Selections

Registered users, whether Guest Users or members of a Group or Subgroup, are provided with the “Member Area” menu selection, as described previously. However, Guest Users, who are members of the default Guest Group, are only provided with a limited set of submenus or options, as illustrated previously in Figure 39, while members of all other Groups or Subgroups, are provided with additional menu features under the “Member Area” menu. These new menu features enable management of Groups and Subgroups, and their content.

Figure 48 shows the full menu selections available to Group and Subgroup members under the “Member Area” menu selection. The capabilities of each selection under the “Member Area” menu are described in the following subsections.

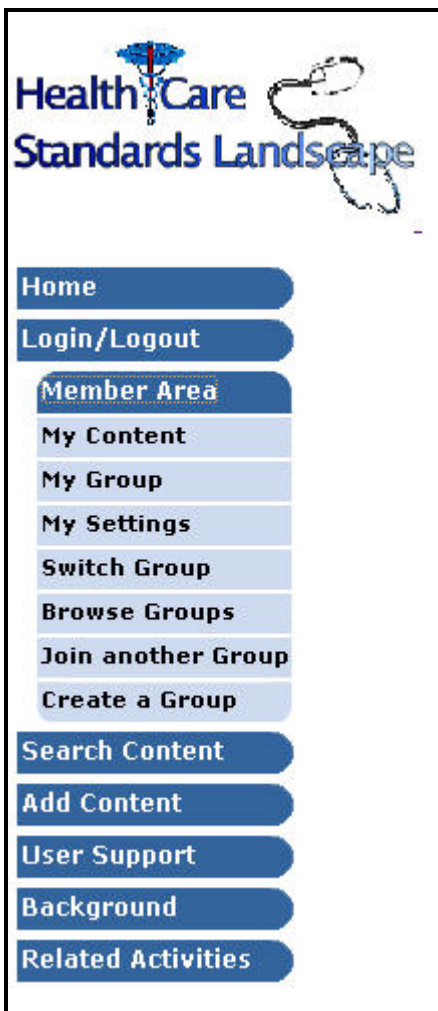

Figure 48 “Member Area” Menu Selections for a Group/Subgroup Member

6.1.1 My Content Menu Selection

Selecting the “My Content” menu selection under the “Member Area” menu displays the entire collection of content submitted, or owned, by the member, within that Group or Subgroup. For example, in Figure 49, selecting the “My Content” menu by a member of the DHHS Group displays their content as shown below:

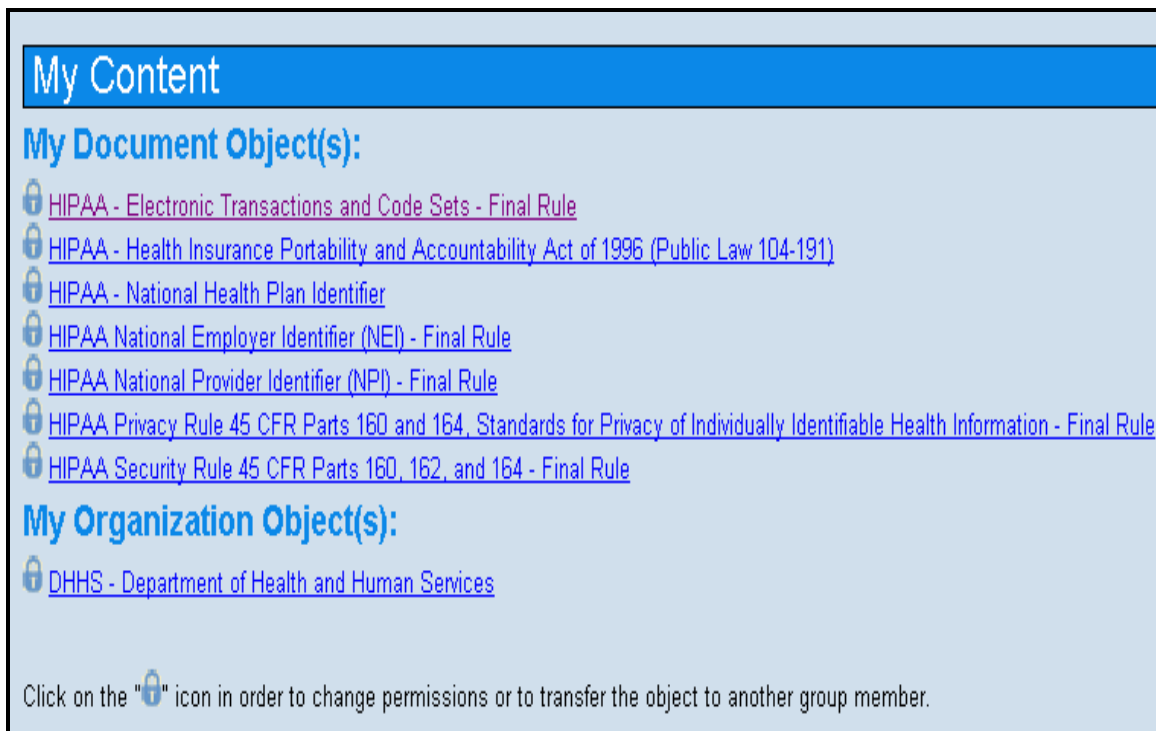



Figure 49 “My Content” Display Listing Member Content

User content, if it exists, is grouped and listed by Document, Organization, and Portfolio content. For this example and user, Figure 49, the names of seven Document Objects and one Organization object are shown; however, Portfolio content was absent and is not shown. By clicking on any of these links, a user may view the data content for the selected object.

6.1.1.1 Change Content Permissions

Typically, most Landscape content can be accessed and viewed by all users as “public” content. However, a content owner or an Administrator of a Group/Subgroup may make their content “private,” to restrict viewing to only the content owner, or to other Group/Subgroup members. Similarly, updating or deleting of content may be limited to the content owner, or shared with other Group/Subgroup members. The content owner may also transfer ownership of their content to another member of the Group/Subgroup, and may restrict whether other users can make relationships with their content. The following describes how content owners may change permissions for their content, and choosing whether other users can make relationships with their content, by using the forms and options that are displayed upon selecting the “My Content” menu selection.

Figure 49 shows member content as a result of selecting the “My Content” menu selection. Note the padlock icon  shown to the left of the content names listed in Figure 49. By clicking this icon, a screen is displayed, shown in Figure 50, which allows the user to change the access permissions on content the user owns, for members of the a) Group/Subgroup, b) parent Group/Subgroup, or, c) other users of the Landscape.

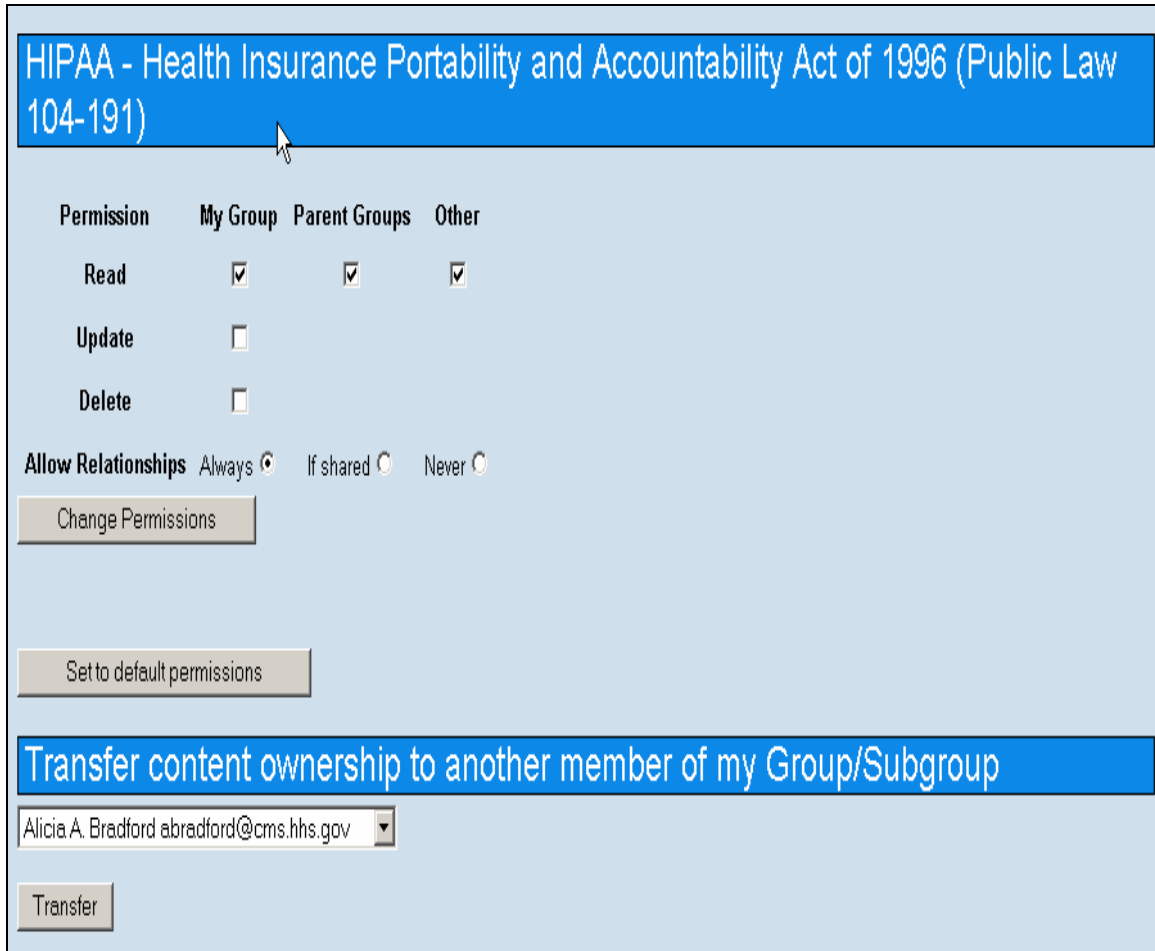

HIPAA - Health Insurance Portability and Accountability Act of 1996 (Public Law 104-191)

Permission	My Group	Parent Groups	Other
Read	<input checked="" type="checkbox"/>	<input checked="" type="checkbox"/>	<input checked="" type="checkbox"/>
Update	<input type="checkbox"/>		
Delete	<input type="checkbox"/>		

Allow Relationships: Always If shared Never

Change Permissions

Set to default permissions

Transfer content ownership to another member of my Group/Subgroup

Alicia A. Bradford abradsford@cms.hhs.gov

Transfer

Figure 50 “My Content Submenu” – Change Content Permissions or Transfer Ownership

Figure 50 shows the default content permissions (checkboxes), as set by the Administrator of the Group/Subgroup. These default permissions are applied when a member adds new content to the Group/Subgroup, and remain in effect unless modified by the owner of the content using the above form.

For example, as shown above, the default permissions for the selected content are:

- READ for all users of the Landscape
- UPDATE and DELETE privileges only for the content owner.

By toggling the checkboxes for UPDATE and DELETE, other members of the same Group/Subgroup as the content owner would also be given permission to update and/or delete this content. Upon clicking the “Change Permissions” button, the permissions will

be changed accordingly. Note, however, that update and delete permissions may not be extended to users outside of this Group or Subgroup.

The content owner may also re-apply the default Group/Subgroup content permissions by selecting the “Set to default permissions” button.

6.1.1.2 Transfer Content Ownership

The Group/Subgroup member may also transfer ownership of their content to another member of their Group/Subgroup by selecting a user name from the drop-down list and clicking on the “Transfer” button, as shown in Figure 50. Note that when content ownership is transferred to another member of the Group/Subgroup, the new owner has full control over the disposition of that content, since the former owner has relinquished control over that content to the new owner.

6.1.1.3 Set Relationship Permissions

In Figure 50, the “Allow Relationships” feature enables a content owner to allow or disallow relationships to be made with their content by other content owners in the Landscape. When a content owner adds new content, the default is to always allow others to make relationships between their content and the content being added (i.e. the “Always” radio button is checked in Figure 50). However, a content owner may change the default to the “If shared” option, or to the “Never” option, by selecting the corresponding radio-buttons, shown in Figure 50. The “If shared” option indicates that a relationship may be made with the owner’s content, only if a relationship made by another content owner allows both parties to update or delete the relationship being made. If not, the other content owner will be prevented from making a relationship between their content and the content having the “If shared” option.

When the “Never” option is selected, other content owners are prevented from making relationships between their content and the content having the “Never” option.

These relationship options and features are described further in Section 6.4

6.1.2 My Group Menu Selection

Selecting the “My Group” menu will display information about a Group/Subgroup for Group Members, as shown in the example, Figure 51. In Section 7, “Establishing and Managing Groups and Subgroups,” additional features provided for Group Administrators will also be discussed. A brief description of the “My Group” menu for the example below follows:

- The top section of Figure 51, indicates which Group/Subgroup a user is currently signed-in to (Group “DHHS” in the figure), and whether the user is signed-in as a Member, or as the Administrator, of the Group/Subgroup.
- A link is also provided for a user to remove themselves from the current Group/Subgroup (described in the following subsection).

- The next section indicates the “Default Permissions,” set by the Administrator, for content in this Group/Subgroup.
- The next section, “My Group Content,” provides a link to display all content names available within the DHHS Group.
- The section, “My Group Members” lists the name, organization, and email address of all members of the Group/Subgroup. By clicking on an email link, the user may send an email to that member.
- The last section, ”Subgroup(s),” lists any Subgroups that exist under the current Group/Subgroup, and the name of the Administrator for the Subgroup. In Figure 51, the Subgroups AHRQ, CDC, CMS, FDA, NCVHS, NISH, NLM, and ONC are shown. In this example, the current Administrator of the DHHS Group and Subgroups is the “hcs_l_admin” (Note, to request to join a Subgroup, the user would follow the procedures described in Section 5.7).

Group DHHS

You are logged in as a member the group: **DHHS**.
Click [here](#) if you want to be removed from this group.

Default Permissions

	DHHS Members	Parent Group Members	Other Members
Read	<input checked="" type="checkbox"/>	<input checked="" type="checkbox"/>	<input checked="" type="checkbox"/>

My Group Content

[See my group content](#)

My Group Members

Administrator	Organization	Email
HCSL Administrator	HCSL	hcs_l_admin@nist.gov
Member Name	Organization	Email
Alicia A. Bradford	CMS	abradford@cms.hhs.gov
J. Michael Fitzmaurice	AHRQ	mfitzmau@ahrq.gov
Patricia Bosley	CMS	patricia.bosley@cms.hhs.gov
Tom	Rhodes	trhodes@nist.gov

Subgroup(s)

Subgroup Name	Administrator
AHRQ	hcs_l_admin
CDC	hcs_l_admin
CMS	hcs_l_admin
FDA	hcs_l_admin
NCVHS	hcs_l_admin
NIH	hcs_l_admin
NLM	hcs_l_admin
ONC	hcs_l_admin

Figure 51 “My Group” Information Display

6.1.2.1 Leave a Group or Subgroup

In the top section of Figure 51, a link is provided for a user to be removed from the current Group or Subgroup. When this link is selected, the user is prompted on whether they really want to be removed from the Group/Subgroup, as shown in Figure 52. If the “Remove” button is selected, the user receives a message that they have been removed from the Group/Subgroup, as shown in Figure 53. When removed, the user is returned to the “Switching to Another Group or Subgroup” form, as described in Section 6.1.4, to allow the user to select another Group or Subgroup to log into.

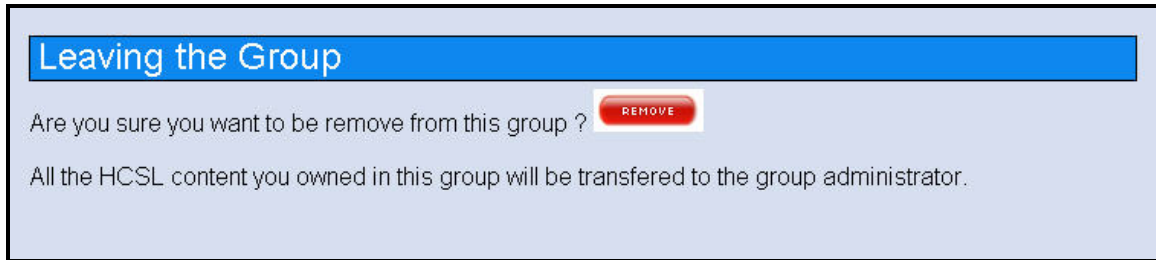

Figure 52 “My Group Menu” – Leaving a Group or Subgroup

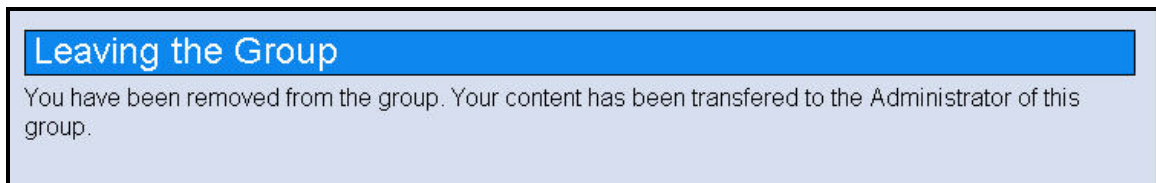

Figure 53 “My Group Menu” – Leaving a Group or Subgroup – You Have Been Removed

Important Notes:

1. A user cannot remove himself or herself from a parent Group or Subgroup unless they first remove themselves from all lower-level subgroups.
2. When a user is removed from a Group or Subgroup, content owned by the user is transferred to the Group or Subgroup Administrator, and remains part of the Group/Subgroup.
3. An Administrator cannot remove himself or herself from a Group or Subgroup that they administer. They must contact the Administrator of the parent Group or Subgroup to request removal or replacement. Only the Administrator of the parent Group or Subgroup can assign, replace, or remove the Administrator of a "child" Subgroup. Similarly, only the HCSL Administrator can assign, replace, or remove an Administrator of a top-level Group.

6.1.3 My Settings Menu Selection

The “My Settings” menu selection allows a member of a Group/Subgroup to change their personal information or password, as shown in Figure 54. Any input field data may be changed on the form. If a new “Login” name is chosen, it must be a login name that is

unique in the Landscape. Changes may be submitted by clicking the “Modify Information,” or “Change your Password” button, as required.

My Settings

You can change your personal information :

Login:

Name:

Organization:

Phone:

Email:

You can change your password :

Old password:

New password:

Figure 54 “My Settings” Display

6.1.4 Switch Groups Menu Selection

A user who is member of more than one Group/Subgroup can switch to another Group or Subgroup, using the “Switch Groups” menu selection. Figure 55 illustrates an example of a user currently logged in to the “Group Test,” who may switch to any Groups and Subgroups displayed by selecting one of the choices and clicking the “Submit” button. The user will then be switched to the selected Group or Subgroup and may login.

Notes:

1. In Figure 55, Groups and Subgroups shown as plain text indicate Groups and Subgroups in which the user is a member, while Groups and Subgroups shown in bold type indicate those in which the user is an Administrator.
2. Displayed Groups and Subgroups are those for which the user uses the same account (i.e. same username and password). The user may have other accounts that are used with other Groups and Subgroups, which are not displayed here.

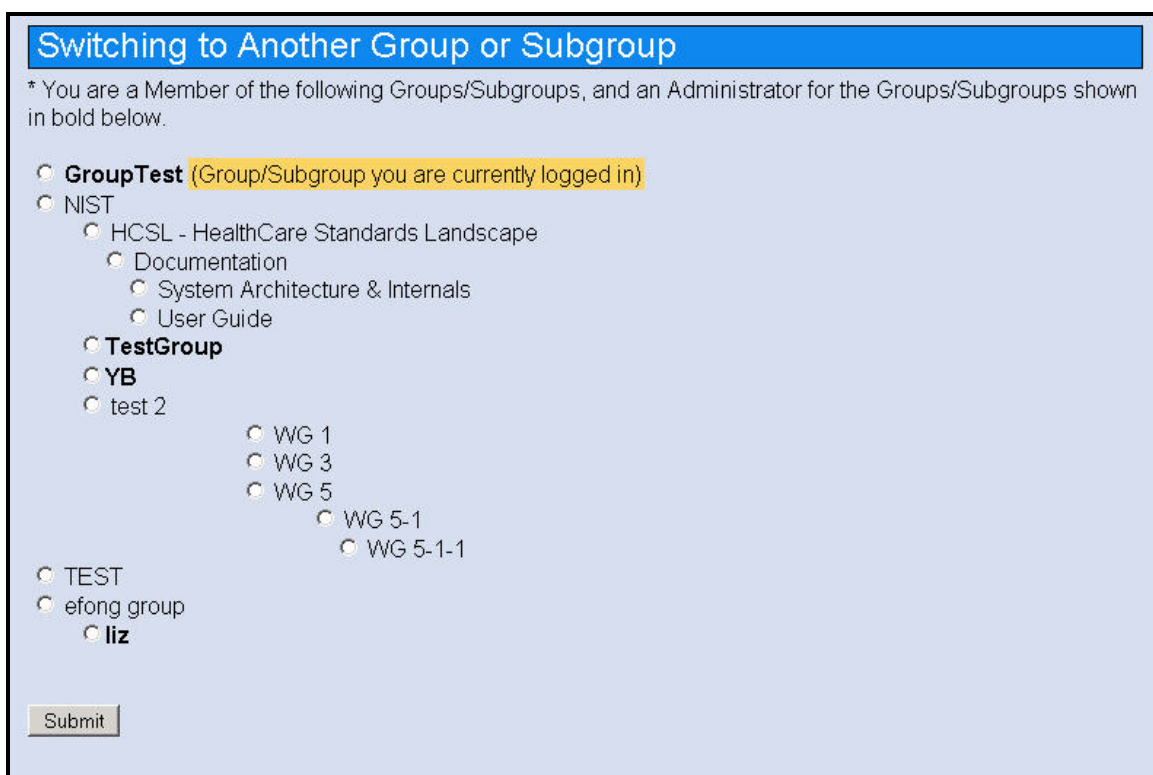

Figure 55 Switch Group

6.1.5 Browse Groups Menu Selection

The “Browse Groups” menu selection was previously discussed in Section 4.5. Please refer to this Section for an explanation and illustrations on this topic.

6.1.6 Join Another Group Menu Selection

The “Join Another Group” menu selection allows a Group/Subgroup member to join another Group or Subgroup, and was discussed previously in Section 5.6 and 5.7. Please refer to these Sections for an explanation and illustrations on this topic.

6.1.7 Create a Group Menu Selection

The “Create a Group” submenu under the “Member Area” menu, as shown previously in Figure 48, allows a Registered User and/or Group Member to request that the HCSL System Administrator establish a new top-level Group within HCSL. The user making the request will be assigned as the Administrator of the new Group. Further information on establishing and managing Groups, including Subgroups, is discussed in Section 7, “Establishing and Managing Groups and Subgroups.”

6.2 Add Content Menu Selection

The capabilities described in this section apply only to members of Groups and Subgroups, other than the Guest Group.

The “Add Content” menu, as shown in Figure 56, provides capabilities to register or add Document, Organization, and Portfolio content descriptions, to Groups or Subgroups, and to make Relationships between instances of these objects.

Users may enter content information either using input forms provided by HCSL, or through an XML file that is a valid instance of the XML schemas used for the content objects (see Section 6.5 and Appendix A - XML Schemas”). The following sections describe how to add content to the Landscape repository, first by using input forms, and then by importing an XML file or entering XML data into an input form-field.



Figure 56 Add Content Drop-Down Menus

6.2.1 Add a Document Instance

Selecting the “Document” submenu, shown previously in Figure 56, allows a user to enter information about a document into the Landscape. Figure 57 below, shows the form for entering information about a Document. Each data field accepts text data (i.e.

alpha-numeric data). Certain data fields, such as, “Document type,” “Document status,” and “Health Care domain(s)” provide drop-down lists of values that can be selected and automatically indexed for use later to search for content using these fields in Boolean queries (see Section 4). By selecting the “Reset” button, all fields are cleared and the user may enter new data.

When data-entry is complete, clicking the “Submit” button will enter the Document description into the repository. A message is given to the user on whether the data was successfully submitted or not. Upon successful submission, the user is returned to the “Register a Document” screen, shown in Figure 57, to allow further data entry.

Register a Document

Do not insert special characters (like the double dashes of MS Word)

You can use [HTMLArea](#)

Name:

Abstract:

Keywords:

Available at:

Document type:

Document status:

Health Care domain(s):

Authors/Editors:

Intellectual Property:

Version:

Issue Date:

Figure 57 Register a Document Instance

Notes:

1. Certain data entry fields automatically expand when the user starts to enter, or edit/update, information. During editing or updating, scroll bars are used with data fields to indicate when there are more lines of information than can be displayed in a field.
2. During data entry, multiple values may be selected from the drop-down lists for indexed data fields, as needed. Holding the shift key down while selecting enumerated values, allows a set of contiguous values to be selected; while holding the control-key down allows non-contiguous values to be selected. In this way, multiple values for the indexed data term can be selected for a Document and later used in Boolean queries to search for content containing those terms and values.

3. The “HTMLArea” link, shown near the top of Figure 57, is an editor for text and HTML editing, which can be used to add or update content, and its appearance, for many data fields using text and HTML. The “HTMLArea” editor may be used to develop new text, or to edit existing text by copying the text from data fields during updating of content (see Section 6.3), pasting it into the “HCSL Area” editing screen, where it can be edited, and then copying and pasting the edited text back into the appropriate data field of the form used for updating content. Further information about the “HTMLArea” editor is presented in Appendix E - HTMLArea Editor.”
4. Certain character encodings may cause problems when submitting data to the HCSL repository. This may happen when a user cuts and pastes information from sources, such as web pages or Word documents, which may contain special codes. Special characters from these sources may cause errors in processing the entry. Some examples are the em-dash, en-dash, ampersand, and colon. The HCSL software corrects many troublesome characters by checking and “filtering” the input data. However, other characters may exist that can cause problems. Many of these problems can be avoided if content is converted to ASCII text before entering or copying it into the HCSL forms. Or, by avoiding use of special characters altogether. If special character problems should occur when submitting or updating content, please notify the HCSL Administrator so that they can be corrected.

6.2.2 Add an Organization Instance

When selected, the “Organization” submenu, shown previously in Figure 56, allows a user to enter information about an organization into the Landscape using an input form. Figure 58 shows the form for entering data describing an organization. Text data may be entered into these fields, many of which will expand to accommodate data entry. Similar to the “Document” form, certain data fields, such as, “Organization type” and “Health Care domain(s),” are indexed data fields that provide drop-down lists of values that may be selected and later used in queries to search for information in the HCSL repository.

When data-entry is complete, the “Submit” button may be clicked to submit the data to the HCSL repository. A user message will indicate whether the entry was successfully submitted or not. Selecting the “Reset” button will clear all fields to allow new data to be entered. Upon successful submission, the user is returned to the “Register an Organization” form.

Register an Organization

Avoid using special characters (like the double dashes of MS Word), which may cause errors.

Optionally, the "[HTMLArea](#)" editor can be used to edit, format, copy, and paste content into HCSL data fields below.

Name:	<input type="text"/>
Mission:	<input type="text"/>
Web site:	<input type="text"/>
Organization type:	Academic <input type="button" value="v"/> <input type="text" value="Accounting/Billing"/> <input type="text" value="Administration/Management"/> <input type="text" value="Alternative Medicine"/> <input type="text" value="Billing (HIPAA)"/> <input type="text" value="Biology"/> <input type="text" value="Biomedicine"/> <input type="text" value="Biotechnology"/> <input type="text" value="Cardiovascular"/> <input type="text" value="Chemicals (UMLS)"/> <input type="text" value="Chemicals - medications"/> <input type="text" value="Chemicals - non-medicine"/> <input type="text" value="Chemistry"/> <input type="text" value="Claims/Payment"/> <input type="text" value="Clinical"/> <input type="text" value="Cytology"/> <input type="text" value="Demographics"/> <input type="text" value="Dentistry"/> <input type="text" value="Disability (ICF)"/> <input type="text" value="Disease Prevention and Control"/> <input type="text" value="Education"/>
Health Care domain(s):	
Scope:	<input type="text"/>
Background:	<input type="text"/>
Charter:	<input type="text"/>
Goals:	<input type="text"/>
Objectives:	<input type="text"/>
Description:	<input type="text"/>
Target Audiences:	<input type="text"/>
Work Items:	<input type="text"/>
Contact Name:	<input type="text"/>
Contact Address:	<input type="text"/>
Contact Email:	<input type="text"/>
Contact Phone:	<input type="text"/>
	<input type="button" value="Submit"/> <input type="button" value="Reset"/>

Figure 58 Register an Organization

6.2.3 Add a Portfolio Instance

An HCSL “Portfolio” is a record that describes a collection of documents that are meaningful to those creating the Portfolio, e.g., a recommended set of standards to realize a specific use case; a set of standards developed, adopted or used by an organization, etc.

For example, an organization may have selected certain use-cases, standards, and implementation guides as the core of their architecture, which together form their “standards” portfolio. This may be represented in the Landscape by a “Portfolio” object, which can provide descriptions of these documents and resources, for others to view. In addition, documents listed in a “Portfolio” may be rendered as hyperlinks to allow access to document descriptions in the HCSL repository, or to the actual documents at another web site.

Selecting the “Portfolio” submenu, shown previously in Figure 56, allows a user to enter information about a portfolio into the Landscape. The “Register a Portfolio” form, shown in Figure 59, is used to enter and register information about a portfolio. The portfolio name is entered into the “Name:” field, while the collection of document titles, descriptions, or references are entered into the “Description:” field. The “Target Audiences:” field is used to identify those groups or persons likely to be interested in or have a stake in this “Portfolio.” The “Available at:” field can be used to enter a URL where further information about the “Portfolio” may be found. Clicking the “Submit” button submits the data to the HCSL repository, while clicking the “Reset” button clears all data fields to allow new data entries.

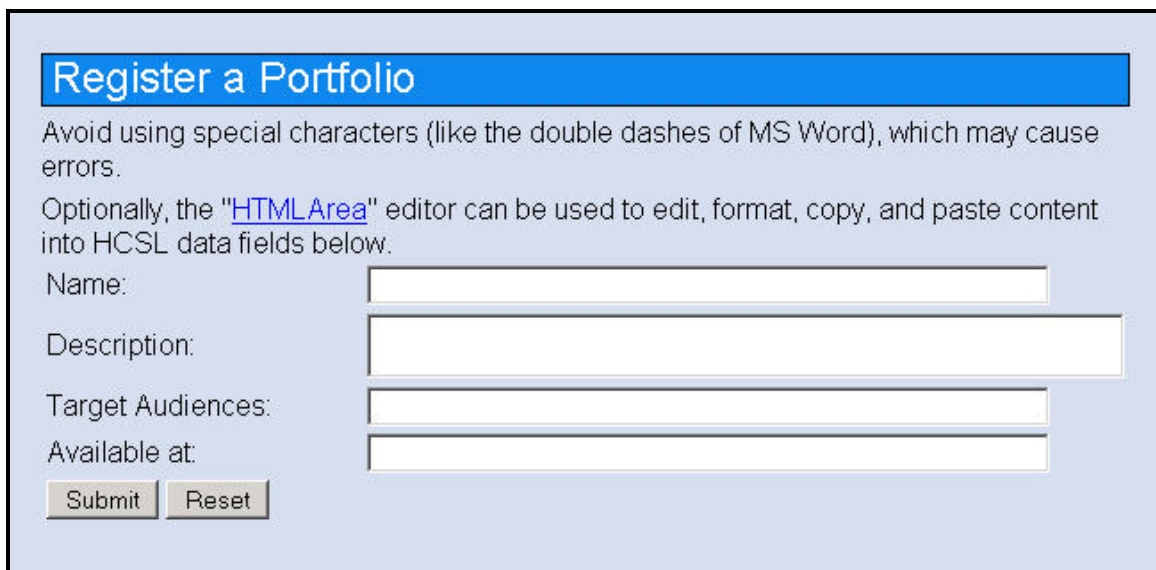

Register a Portfolio

Avoid using special characters (like the double dashes of MS Word), which may cause errors.

Optionally, the [HTMLArea](#) editor can be used to edit, format, copy, and paste content into HCSL data fields below.

Name:

Description:

Target Audiences:

Available at:

Figure 59 Register a Portfolio

By clicking the “HTMLArea” editor link, a user can add or edit text content, add URLs, or modify the appearance of text in the “**Description:**” field using HTML tags. The “HTMLArea” editor is covered in more detail in Appendix E - HTMLArea Editor.”

6.3 Update or Delete Content

A Group Member who owns content in a Group or Subgroup may update or delete that content. To do this, the user must first log in to their Group or Subgroup and then retrieve and display the content to be updated or deleted. Figure 60, shows the content for the sample document, “Test Doc – 1911 Solvey Conference.”

The screenshot shows a web interface for a document titled "Test Doc - 1911 Solvey Conference". At the top right is a "Back" button. Below the title is a "Relationship(s)" section with a link "Browse Relationship(s)". The main content area contains an "Abstract" section with a black and white photograph of a group of men in suits sitting around a long table. Below the abstract is a metadata table with the following entries:

Keywords	Einstein, Curie, Heisenberg, Physics, Solvey
Available at	http://hcs1.sdct.nist.gov/
Document Type	Web Page (HTML)
Document Status	Draft
Health Care Domain	None
Authors/Editors	trr
Intellectual Property	TEST
Version	0.1
Issue Date	Today
Registration date	12/3/2004 18:54:39
Owner	hcs1_admin
Group	Group information
Last Update	8/10/2006 16:5:4
Update	Update this Document

At the bottom of the page, there is a "Delete" button.

Figure 60 Sample Document showing Update and Delete Controls

Shown near the bottom of this display is an “Update” field, with an “Update this Document” link, and a “Delete” button. These two features are only visible or displayed to the owner of the document, or to Group/Subgroup members who have been given update/delete permissions for this document, by the document owner.

Clicking the “Update this Document” link brings up a form, similar to the form for adding a new document, where the user can add or change information in any of the data fields, as shown for this example in Figure 61. A “Back” button is available to return to the previous screen. After making additions or changes, clicking the “Update” button, at the bottom of the screen, will update the document in the HCSL repository. Upon completing the Update process, the updated document is displayed to the user.

Document

Optionally, the "HTMLArea" editor can be used to edit, format, copy, and paste content into HCSL data fields below.

Name	Test Doc - 1911 Solvey Conference
Abstract	<html> <body>
Keywords	Einstein, Curie, Heisenberg, Physics, Solvey
Available at	http://hcs1.sdct.nist.gov/
Document Type	Web Page (HTML)
Document Status	Draft
Health Care Domain(s)	<div style="border: 1px solid gray; padding: 2px;"> None Accounting/Billing Administration/Management Alternative Medicine </div>
Authors/Editors	trr
Intellectual Property	TEST
Version	0.1
Issue Date	Today
Reviewed/Updated	
Last Reviewed/Updated	

Figure 61 Form for Updating a Document

If the “Delete” button is selected, as shown in Figure 60, the user is asked to confirm the selection, and if confirmed, the document is deleted from the HCSL repository. Upon completion of the Delete process, the user is returned to the “Document Search” form (see Section 4.1).

Note that an owner of content may change the access permissions on their content, or transfer ownership, as was as previously described in Section 6.1.1.1 “Change Content Permissions.”

6.4 Add, Update, and Delete Relationships Between Content

Relationships are logical connections made by a user between Landscape content entities that provide additional information about these objects. For example, an organization may develop, publish or use a document or portfolio. Or an organization or may be related to another organization, or a document to another document. A content owner may add, update, or delete Relationships among content they own.

6.4.1 Adding a Relationship Between Content

The capability to add relationships between content in the Landscape provides additional information about relationships that may exist between these entities, and provides a useful way to search for information in the Landscape using relationships. As described previously, Section 4.4 explains how to search for content based on relationships with other content.

This section describes the steps for adding content relationships, and whether other content owners will be allowed to update or delete a relationship that is made with their content (discussed further in the next Subsection). Note that a Group/Subgroup member can always add relationships between content they own. However, content owners can only add relationships between their content and content owned by others, if other content owners have allowed relationships to be made with their content. This is explained further below.

Selecting the “Relationship” submenu, shown before in Figure 56, enables a user to add relationships between their content (*source content*) and content of other users (*target content*) in the Landscape. A relationship can always be made between *source* and *target* content owned by a Group Member. However, when adding a relationship with content owned by another Group Member, or a member of another Group, the *target* content permissions must be set to allow relationships to be made with it. This was described earlier in Section 6.1.1.1, and will be described further in Section 6.4.1.1. In the following examples, however, it is assumed that relationships can be made between all selected content, i.e. between *source* and *target* content.

The process of adding a relationship involves two steps. The first step uses a form, as shown in Figure 62 below, to select a pair of content types that a relationship will be made between.

Create Relationships

This page allows you to create a relationship between one of **your registered objects** and another object. Choose the type of relationship you want to create:

Source		Target
Document	<input checked="" type="radio"/>	<input checked="" type="radio"/> Document
Organization	<input type="radio"/>	<input type="radio"/> Organization
Portfolio	<input type="radio"/>	<input type="radio"/> Portfolio

What type of permission do you want for this relationship ?

You and the target object's owner can update/delete the relationship

You are the only one who can update/delete the relationship

Figure 62 Create Relationships - Select Relationship Pair (Document-to-Document illustrated)

Using the radio-buttons shown in Figure 62, a user selects a pair of content types that they wish to add a relationship between. In this example, the “Document-to-Document” relationship was selected. As can be seen, the possible Relationships between pairs of content types are:

- Document – to – Document
- Document – to – Organization

- Document – to – Portfolio
- Organization – to – Organization
- Organization – to – Document
- Organization – to – Portfolio
- Portfolio – to – Portfolio
- Portfolio – to – Document
- Portfolio – to – Organization

After a user has selected a Relationship-pair and clicked the “Submit” button, the next step involves completing a second form, shown in Figure 63, to select specific content instances for the chosen *source* and *target* content types, and to select a specific type of relationship to be made between them. These selections are made from choices listed in the drop-down menus, as shown in Figure 63.

Figure 63 Selecting Specific Documents and a Relationship

In Figure 63, the first drop-down menu is used to select the *source* document. The next drop-down menu is for selecting the type of relationship to be made. And the last drop-down menu is for selecting the *target* document.

In this example, the selected *source* and *target* documents, and relationship, are: “ADA Technical Report No. 1018 *is associated with* ADA Technical Report No. 1019” (these documents are published by the American Dental Association - ADA).

In the next example, Figure 64, the user has selected the content pair, “Document-to-Organization,” and selected the relationship *publishes* between the organization ADA and the document, “ADA Technical Report No. 1010”; i.e. the designated relationship is, “ADA *publishes* ADA Technical Report No. 1010.”

Document - Organization Relationship

Organization:
ADA - American Dental Association

Relationship Type:
publishes

Document:
ADA Technical Report No. 1010 - Accounting Performance for Dental Information Systems

Submit

Figure 64 Selecting a Specific Organization to Document Relationship

Upon successful submission, the user is returned to the “Create Relationship” form, Figure 62.

Note that if a user attempts to submit a relationship that already exists between the selected content, an error message will be displayed indicating that a relationship already exists between the two content items.

Note that in adding relationships, a user is responsible for ensuring that the relationship being made between any two content objects makes logical sense. For example, in the following relationships, an “organization *Publishes* a document” and a “document *Is Published By* an organization,” either relationship is possible and logical. However, in the relationships, an “organization *Publishes* a document” and a “document *develops* an organization,” only the former relationship makes logical sense.

As described previously in Section 4.1.4, existing relationships for any content object can be viewed by clicking on the “Browse Relationship(s)” link that appears near the top of the content being displayed. Clicking this link will display any relationships that may exist for the content object.

As described previously in Section 4.4, a relationship may be used to search for content, having that relationship with other content.

6.4.1.1 Setting Relationship Permissions

When adding a relationship, two radio-button options are available for controlling who may update or delete the relationship, as shown in Figure 62. These two options are shown under, “What type of permission do you want for this relationship?” The first option is the default option:

- **“You and the target object’s owner can update/delete the relationship,”**

And the second option is:

- **“You are the only one who can update/delete the relationship,”**

The first option allows both the owners of the source and target content to update or delete the relationship. The second option only allows the user adding the relationship, or the owner of the source content, to update or delete the relationship.

Note, however, as was described in Section 6.1.1.1, the ability to add a relationship with content owned by another user depends on whether that user allows relationships to be made with their content. A user can always add relationships between content they own. However, a user can only add a relationship between content they own (*source content*) and content owned by another user (*target content*), providing the owner of the *target* content has allowed relationships to be made with their content.

As was described in Section 6.1.1.1, content owners can allow or prevent relationships being made with their content. Recall, that a content-owner can either:

- 1) Always allow relationships to be made with their content (*Always - default*);
- 2) Conditionally allow or prevent relationships to be made with their content depending on whether they are also allowed to update or delete a relationship that is made by another user (*If shared*); or,
- 3) Prevent any relationships from being made with their content (*Never*).

In the first case, a relationship can always be made with the content. In the second case, a relationship can be made only if the relationship being made can be updated or deleted by both the owner of the *source* content, who is adding the relationship, and by the owner of the *target* content, who has set the *If shared* condition on their content. In the third case, the content-owner has disallowed any relationships to be made with their content.

Figure 65 below, illustrates the conditions under which a relationship may be made by content-owner A, between the *source* content A, owned by content-owner A, and the *target* content B, owned by content-owner B:

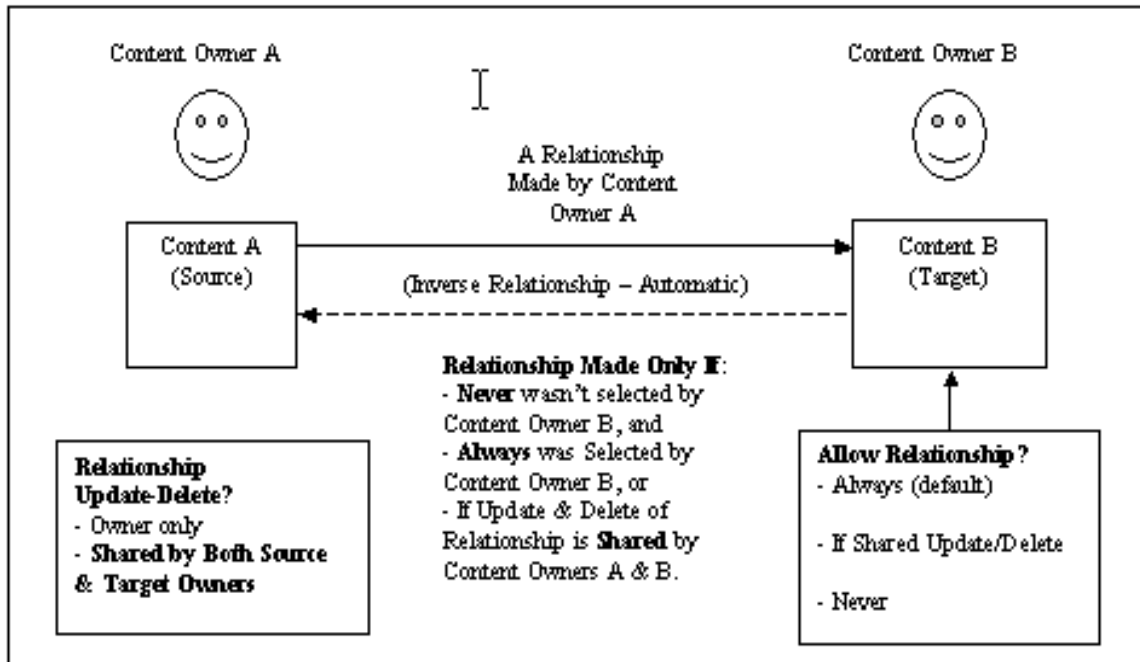

Figure 65 Effects of Content and Relationship Permissions on Adding a Relationship

In this illustration, Owner A, of Content A, wants to add a relationship with Content B, owned by Owner B. The relationship can be made by Content-Owner A, only if the following conditions apply:

- Content Owner B has not selected the option “*Never*” for “Allow Relationships” for Content B;

And either:

- Content Owner B uses the default setting of “*Always*” for “Allow Relationships” for Content B (See Figure 50). In this case, Content Owner A may choose either option for updating or deleting the relationship when setting the permissions for “What type of permissions do you want for this relationship?” (See Figure 62);

Or,

- Content Owner B selects *If shared* for “Allow Relationships” with Content B (see Figure 50), and Content-Owner A selects “*You and the target object’s owner can update/delete the relationship*” when setting the permission for “What type of permissions do you want for this relationship?” (See Figure 62).

Note that the permissions set for content on whether a relationship may be made with the content, and the permissions set for a relationship on who may update or delete the relationship, are independent and separate permission controls; the former on the content, and the latter on the relationship. Each may be set independent of the other. However, the ability of a user to add a relationship with content owned by other users depends on the settings of both permissions, as described above.

The following summarizes the possible permission options for content and relationships:

Content Relationship Permission Options (Section 6.1.1.1)

- Can always add a relationship with content (*Always*).
- Can add a relationship with content if both content owners can update or delete the relationship (*If shared*).
- Can never add a relationship with content (*Never*).

Relationship Update/Delete Permission Options (Section 6.4.1.1)

- Only the user who adds the relationship can update/delete the relationship.
- Both the user adding the relationship and the owner of the target content can update/delete the relationship.

6.4.2 Update or Delete a Relationship Between Content

Relationships between content that have been made by a user may also be updated or deleted by that user. In addition, as described above, relationships whose permissions allow shared update and delete by owners of the content involved in the relationship, may also update or delete the relationship. The content owner(s) may do this by:

- Logging in to the Group or Subgroup containing one of the content objects in the Relationship.
- Displaying the content for that object, and selecting the “Browse Relationship(s)” link. This will display all Relationships for that object, as shown in the example for the “HL7 Organization” in Figure 66. In this example, Relationships are shown between the “HL7 Organization” instance and other Documents, Portfolios, and Organizations in HCSL repository.
- Selecting the “Update” button on the right side of displayed Relationships, shown in Figure 66, to display an update form, shown in Figure 67, with a drop-down list of Relationships, from which the user may select a new relationship.
- After choosing a relationship, selecting the “Submit” button will complete the change; selecting the “Back” button returns the user to the display of content relationships.
- Alternatively, as shown in Figure 66, a user may select the “Delete” button next to a relationship to delete it.

HL7 - Health Level Seven				
Relationships with Document(s)				
HL7 - Health Level Seven	develops	Arden Syntax for Medial Logic Systems v2.6	<input type="button" value="Update"/>	<input type="button" value="Delete"/>
HL7 - Health Level Seven	is referenced by	AHRQ - Current Activities of Selected Healthcare Informatics Standards Organizations (aka "The Yellow Book")	<input type="button" value="Update"/>	<input type="button" value="Delete"/>
HL7 - Health Level Seven	develops	HL7 RIM	<input type="button" value="Update"/>	<input type="button" value="Delete"/>
HL7 - Health Level Seven	develops	HL7 CDA - Clinical Document Architecture	<input type="button" value="Update"/>	<input type="button" value="Delete"/>
HL7 - Health Level Seven	develops	HL7 Messaging	<input type="button" value="Update"/>	<input type="button" value="Delete"/>
Relationships with Portfolio(s)				
HL7 - Health Level Seven	manages	HL7 Portfolio	<input type="button" value="Update"/>	<input type="button" value="Delete"/>
HL7 - Health Level Seven	manages	HL7 Version 3	<input type="button" value="Update"/>	<input type="button" value="Delete"/>
Relationships with Organization(s)				
HL7 - Health Level Seven	is member of	HITSP - Healthcare Information Technology Standards Panel (ANSI)	<input type="button" value="Update"/>	<input type="button" value="Delete"/>
HL7 - Health Level Seven	is member of	ANSI - American National Standards Institute	<input type="button" value="Update"/>	<input type="button" value="Delete"/>
HL7 - Health Level Seven	is member of	HISB - Healthcare Informatics Standards Board (ANSI)	<input type="button" value="Update"/>	<input type="button" value="Delete"/>
<input type="button" value="Back"/>				

Figure 66 Example of Relationships for the Organization HL7

Update Relationship		
This allows you to update the relationship between an Organization and Document.		
Organization: <input type="text" value="HL7 - Health Level Seven"/>	Relationship/Direction <input type="text" value="publishes"/>	Document: <input type="text" value="HL7 RIM"/>
<input type="button" value="Submit"/>		
<input type="button" value="Back"/>		

Figure 67 Example of Updating a Relationship Between the HL7 Organization and a Document

In this example, the Relationship between the “HL7” organization and the document “HL7 RIM” is being changed from “*develops*” to “*publishes*,” which was chosen from the drop-down list of possible Relationships from which to choose. By clicking the “Submit” button, the change will be made to this Relationship, and will be displayed as revised in the “HL7 Relationships” page, shown in Figure 66.

To delete a Relationship, a user would click the “Delete” button on the right side of the selected Relationship, as shown in Figure 66, and the chosen Relationship would be deleted between the two HCSL objects.

6.4.3 Types of Content Relationships

The HCSL provides for various types of Relationships to be selected and used between pairs of content objects. For different pairs of content-types, a corresponding set of Relationships are provided that describes possible logical relationships that might exist between these type objects. Further, when a relationship is selected between a source and target object, there is an inherent “direction” to the relationship between the objects that makes grammatically sense.

For example, as shown previously in Figure 64, the selected relationship, *publishes*, is between an Organization (ADA) and a Document (ADA Technical Report No. 1010), i.e. “ADA *publishes* ADA Technical Report No. 1010.” It would be illogical, however, to add a relationship between this Document and Organization that stated, “ADA Technical Report No. 1010 *publishes* ADA.” But, it would be logical if the reverse relationship were stated as, “ADA Technical Report No. 1010 *is published by* ADA.” Hence, the relationship and direction should be logically consistent between the source and target objects to provide a “correct” semantic meaning that makes logical sense when viewing content relationships, or performing relationship-based searches.

In adding relationships between pairs of objects, HCSL provides a list of Relationships that are logically consistent with the direction of a relationship between the selected source and target objects, as was illustrated in the above example. In addition, when a relationship is made between the source and target objects, HCSL automatically assigns a “reverse” or inverse relationship from the target to the source object that is consistent with the selected source to target relationship.

Thus, in the example above, when a user adds the relationship “ADA *publishes* ADA Technical Report No. 1010,” the reverse relationship, “ADA Technical Report No. 1010 *is published by* ADA,” is automatically made by HCSL. Hence, when viewing relationships for the organization “ADA” (source content), the relationship “*publishes*” will be displayed associated with “ADA Technical Report No. 1010” (target content). However, when the relationships for the document, “ADA Technical Report No. 1010,” (target content) are viewed, the inverse relationship, *is published by*, will be displayed associated with the “ADA” organization (source content).

Table 1 HCSL Content Relationships and Inverse Relationships, provides a list of Relationships and corresponding Inverse Relationships used in the Landscape.

Table 1 HCSL Content Relationships and Inverse Relationships

Relationship	Inverse Relationship
adopts	is adopted by
derives	is derived from
develops	is developed by
distributes	is distributed by
has association with	is associated with
has equivalence with	is equivalent to
has liaison with	is liased with
has member	is member of
has part	is part of
has similarity with	is similar to
has version	is version of
includes	is included by
is adopted by	adopts
is associated with	has association with
is child of	is parent of
is derived from	derives
is developed by	develops
is distributed by	distributes
is equivalent to	has equivalence with
is included by	includes
is liased with	has liaison with
is maintained by	maintains
is managed by	manages
is member of	has member
is parent of	is child of
is part of	has part
is published by	publishes
is referenced by	references
is replaced by	replaces
is required by	requires
is similar to	has similarity with
is updated by	updates
is used by	uses
is version of	has version

maintains	is maintained by
manages	is managed by
publishes	is published by
references	is referenced by
replaces	is replaced by
requires	is required by
updates	is updated by
uses	is used by

6.5 XML Menu Selection

Since the Landscape implementation uses XML, the power and convenience of entering content into the HCSL repository using XML files is available to a user who is familiar with this technology. The “XML” submenu under the “Add Content” menu, shown in Figure 56, allows the user to either import an XML file, or insert an XML description of the content for a Document, an Organization, or a Portfolio using the “Input Box” shown near the bottom of Figure 68, “Register an XML Instance.” In either case, the XML must be a valid instance of the XML Document, Organization, or Portfolio schema used by HCSL. When submitted, the XML data will be checked against the corresponding XML schema, for that type of HCSL object, and the user notified if there were any errors.

Register an XML instance

This page allow you to insert a document, an organization or a portfolio via an XML document. This file must be an instance of either the [document schema](#), the [organization \(entity\) schema](#) or the [portfolio schema](#) (Select link to view schema).

Choose the type of instance you want to insert :

Document:

Organization:

Portfolio:

Select the XML instance you want to insert :

XML File:

Or copy and paste the XML instance into the input box below:

Figure 68 Enter and Register XML Instance Data

Each of the XML schemas may be viewed by clicking the link for “document schema,” “organization schema,” or “portfolio schema,” found near the top of the display screen, shown in Figure 68. Clicking one of these highlighted links will display the schema, typically within a browser window, which can then be saved and used to create a valid

XML instance file, for the selected type of content, using an appropriate XML development and editing tool (e.g. XMLSpy®ⁱⁱ, etc.). The XML instance data may then be saved as a file and later imported into HCSL using the “Browse” button, shown in Figure 68.

Alternatively, the XML instance data may be entered directly, or copied and pasted, into the “Input Box,” shown in Figure 68. Once the XML file or data have been specified, clicking the “Submit” button will enter the XML data into the HCSL repository. The XML data will be checked against the schema to see if it is valid and well-formed XML, and a message will be displayed for the user informing them if the input data was accepted, or if there were errors in the data. Upon successful submission, the “Register an XML Instance” screen is again displayed to enable input of additional XML instance data.

7 Establishing and Managing Groups and Subgroups

As discussed previously in Section 2 and Section 5.2, the HCSL or Landscape supports establishing Groups and Subgroups, each with their own members, administrators, and content. Please refer to these Sections for background information on Groups and Subgroups. This section describes how Groups or Subgroups may be established, managed, and removed within HCSL.

Groups and Subgroups in the Landscape have a hierarchical structure, with Groups able to have Subgroups, and Subgroups able to have Sub-Subgroups, and so on, each with their own members and administrator drawn from a parent Group or Subgroup, and content which are managed by members of the Group or Subgroup.

7.1 Establishing a Group

Any Registered User may request to establish a Group in the Landscape for managing their content or the content of other Group members. Upon receiving a request from a Registered User to establish a Group, the Landscape System Administrator establishes a “top-level” Group and assigns the Registered User making the request to establish a Group, as the Group Administrator to manage Group functions. However, the HCSL System Administrator, as required, may switch this Administrative role to another Group Member.

When a new Group is established, the System Administrator informs the Group Administrator by email. The Group Administrator may then log in to their Group with their username and password to manage content, membership, establish Subgroups, and assign Subgroup Administrators.

ⁱⁱ XMLSpy is a registered trademark of Altova, Inc.

To request that a new Group be established in the Landscape, a Registered User selects the “Create a Group” submenu under the “Member Area” menu, as shown previously in Figure 48, which will display the “Creating A Group” screen, shown below in Figure 69.

Creating a Group

If you want to create an HCSL Group, please complete and submit this form. An email will be sent to the HCSL administrator who will then create the group. When this Group is created, you will be assigned as the Group Administrator. Please review the HCSL FAQ and User Guide, or contact the HCSL Administrator, for further information on the roles and privileges of a Group Administrator.

Group Name:
HL7 Working Group 5 (Sample)

Group Description:
A (Sample) working group with members from many HL7 committees. Formed in early 2006

Objectives:
To coordinate and further the work of medical device electrical safety standards that is being managed in separate committees.

submit

Figure 69 Creating a Group

This form is used to enter a name for the Group, a description of the Group, and the objectives or purpose for the Group. When complete and submitted, the request is sent to the HCSL Administrator who will then establish the group. When the Group is created, the Registered User who submitted the request, will be notified and assigned as the Group Administrator, with the roles and privileges described previously in Section 5.3.5.

7.2 Member Area Menu Selections for Group/Subgroup Administrators

In Section 6.1, the “Member Area” menu selections were discussed primarily for Registered Users or Group/Subgroup members who are not the Group/Subgroup Administrators. This Section discusses additional features available to Group and Subgroup Administrators for managing a Group or Subgroup.

7.2.1 My Group Menu Selection

Figure 70 shows a display screen for the “DHHS” Group, as seen by the Group Administrator who has logged into this Group, and who has selected the “My Group” menu selection. A Subgroup Administrator, logging into their Subgroup, would see a similar screen for their Subgroup upon selecting the “My Group” menu selection.

The screenshot displays the 'My Group DHHS' interface. At the top, it indicates the user is logged in as the Administrator of the group 'DHHS'. Below this, there are sections for 'Default Group Content Access Control Permissions', 'Group Information', 'My Group Content', 'My Group Members', 'My Subgroup(s)', 'Add a Member', and 'Create a Subgroup'.

Default Group Content Access Control Permissions

DHHS Members Parent Group Members Other Members

Read

[Change Permissions](#)

Group Information

Group Name: [Change Group Name](#)

Group Description: [Change Group Description](#)

My Group Content

[See my group content](#)

My Group Members

Login	Name	Organization	Email	Remove
abradford	Alicia A. Bradford	CMS	abradford@cms.hhs.gov	
mfitzmau	J. Michael Fitzmaurice	AHRQ	mfitzmau@ahrq.gov	
pbosley	Patricia Bosley	CMS	patricia_bosley@cms.hhs.gov	
trhodes	Tom	Rhodes	trhodes@nist.gov	

My Subgroup(s)

Subgroup Name	Administrator	Delete	Change Admin
AHRQ	hcs1_admin		
CDC	hcs1_admin		
CMS	hcs1_admin		
FDA	hcs1_admin		
NCVHS	hcs1_admin		
NIH	hcs1_admin		
NLM	hcs1_admin		
ONC	hcs1_admin		

Add a Member

[Submit](#)

Create a Subgroup

Subgroup Name:

Subgroup Administrator:

[Submit](#)

Figure 70 Example of “My Group” Display for the Group Administrator of the DHHS Group

This display is similar to what a Group Member would see upon selecting the “My Group” menu selection, but with additional capabilities for the Group Administrator to:

- Set or change the default content access controls.
- Provide a name and description of the Group or Subgroup.
- Add or remove Group or Subgroup members.
- Add or remove Subgroups.
- Add, change, or remove Subgroup Administrators.

Using Figure 70 as an illustration, the administrative capabilities provided for Group, and Subgroup Administrators, are described in the sections below:

7.2.1.1 My Group Section

At the top of the screen, the “My Group” Section informs the Administrator which Group/Subgroup that they are logged into. In the example of Figure 70, the Administrator is “...logged in as the Administrator of the group: DHHS.”

7.2.1.2 Changing Group/Subgroup Default Content Access Control Permissions

The section “Default Content Access Control Permissions” shows the default settings for Group/Subgroup content “Read” permissions, as indicated by the checkboxes shown at the top of Figure 70. The Group/Subgroup Administrator may modify the “Read” permissions by toggling the appropriate checkboxes on or off.

Note that content owners may override the default settings for their content, by changing the default permissions for “Read,” “Update,” and “Delete,” and they may also transfer ownership of their content to another Group/Subgroup Member. See Section 6.1.1.1.

7.2.1.3 Setting Group/Subgroup Name and Description

Under the “Group Information” section, the Group Administrator may change the Group Name or Group Description.

7.2.1.4 View Group/Subgroup Content

The “My Group Content” section allows viewing the titles of all content in the Group. This feature is available for both the Group/Subgroup Administrator and Members, as was previously described in Section 6.1.2 for Group Members.

7.2.1.5 My Group Members Section

Under “My Group Members” section, the Group/Subgroup Administrator may view contact information for all Group/Subgroup members, and may “Remove” Group/Subgroup members by clicking the “X” under the “Remove” column, next to a users name. Note that if a Group/Subgroup member to be removed is currently a member of a Subgroup, they must first be removed from all Subgroups before they can be removed from the current Group. If a Group/Subgroup Administrator tries to remove a

member who is still a member of a Subgroup, they will receive an alert message, as shown in Figure 71 informing them that the member must not belong to any Subgroups (before they can be removed from the Group). Note, adding a member to a Group or Subgroup is described below in Section 7.2.1.7.

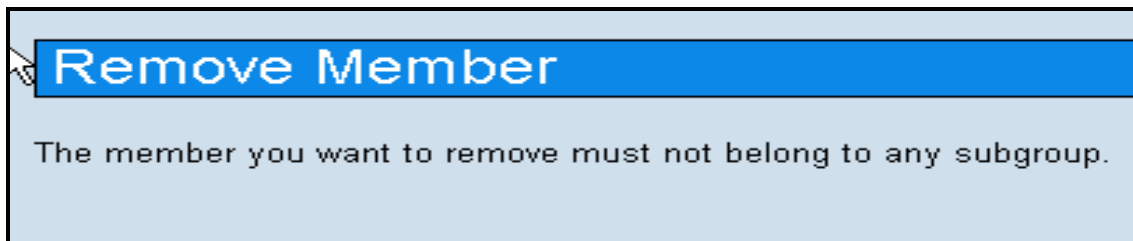

Figure 71 “Remove Member” Alert Message to an Administrator

7.2.1.6 My Subgroup(s) Section

Under the “My Subgroup(s)” section, the Group Administrator may “Delete” or remove “Subgroups,” or change “Subgroup Administrators” by selecting the appropriate control button. To change the “Subgroup Administrator,” the Group Administrator would select the “Change Admin” button, and choose another Group member from a drop-down list, to be the new Subgroup Administrator.

7.2.1.7 Add a Member Section

Under the “Add a Member” section, the Group Administrator may add members to the Group by selecting names from the drop-down list that contains the names of all members of the parent Group. For all Groups in HCSL, the parent Group is the top-level Group “HCSL.” Hence, the list of names in the drop-down list will be that of all Registered Users known to HCSL. In this example, Figure 70, the DHHS Group Administrator may select names of Registered Users to add as members to the DHHS Group.

Note that the Group Administrator may add any Registered User to their Group using this drop-down list of names, regardless of whether the user previously made a request to join the Group, as described previously in Section 5.6. If a request were made by a user to join the Group, the Group Administrator would still use the drop-down list to select and add the user as a member of the Group.

Note, removing a member from a Group or Subgroup is described in Section 7.2.1.5.

7.2.1.8 Create a Subgroup Section

Under the “Create a Subgroup” section, the Group Administrator may establish a Subgroup under the current Group, and assign a Subgroup Administrator for the new Subgroup by selecting a name from the drop-down list of Group Members.

7.3 Modifying Group/Subgroup Default Content Permissions

The Administrator of a Group or Subgroup can change or set the default “Read” access permissions for Group/Subgroup content for a) members of the Group/Subgroup, b) members of the parent Group/Subgroup, and c) other users of HCSL, by toggling the check boxes, shown in Figure 72, and clicking the “Change Permissions” button.

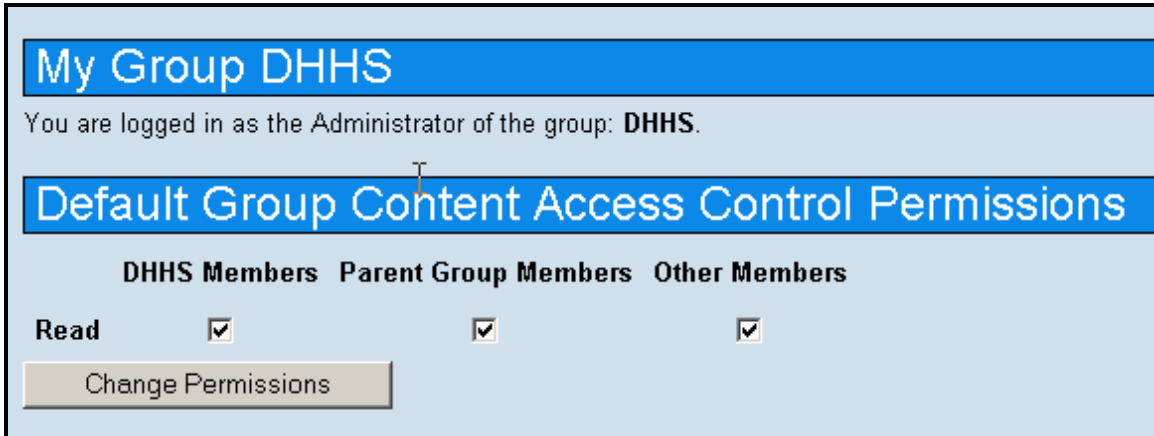

Figure 72 My Group DHHS – Default Access Permissions for Group/Subgroup Content

In this example, the default Group content access permissions for the “DHHS” Group example allows all users of HCSL to “Read” or view content that is part of the DHHS Group. This includes members of the DHHS Group, the parent Group (which is the top-level HCSL Group that includes all Registered Users of HCSL), and all other users of HCSL.

Note, however, that the Administrator only controls the default “Read” permission on Group content. However, Group/Subgroup members may also modify the “Update” and “Delete” permissions, as well as the “Read” permission, on their content for other Group/Subgroup Members, as was described in Section 6.1.1.1. This capability gives the content owner full control over their content to change or modify default Group content permissions, as required, e.g. to temporarily make certain content “private” or un-viewable to non-Group/Subgroup members, or to allow Group/Subgroup members to update and/or delete their content.

7.4 Adding a Subgroup

The Administrator of a Group or Subgroup may establish subgroups under the Group or Subgroup that they administer. Each Subgroup administrator may establish further Subgroups within their Subgroup. To create a Subgroup, the Administrator of a Group or Subgroup first logs in to their Group or Subgroup and selects the “My Group” submenu under the “Member Area” menu selection. The “My Group” screen will be displayed as shown in Figure 73.

My Group GroupTest

You are logged in as the Administrator of the group: **GroupTest**.

Default Group Content Access Control Permissions

GroupTest Members **Parent Group Members** **Other Members**

Read

Group Information

Group Name:

Group Description:

My Group Content

[See my group content](#)

My Group Members

Login	Name	Organization	Email	Remove
user4	user4	user4	clement.ridoret@nist.gov	<input type="button" value="X"/>
user5	user5 (Roy Morgan)	NIST ITL, HCSL Development Team	roysmorgan@comcast.net	<input type="button" value="X"/>
tang	Hai Tang	NIST	hai.tang@nist.gov	<input type="button" value="X"/>
user3	user3	user3	clement.ridoret@nist.gov	<input type="button" value="X"/>

My Subgroup(s)

Subgroup Name **Administrator** **Delete** **Change Admin**

Add a Member

None

null null null

null null test_date4tgo

user1 user1 clement.ridoret@nist.gov

user2 user2 clement.ridoret@nist.gov

user4 user4 clement.ridoret@nist.gov

Leroy Morganfong HCSL Testing Team efong@nist.gov

Tom Rhodes NIST trhodes@nist.gov

Roy Morgan NIST rmorgan@nist.gov

null null null

GUEST null null

Clement Ridoret NIST cridoret@nist.gov

Test Test test

test test clemusa@gmail.com

user5 (Roy Morgan) NIST ITL, HCSL Development Team roysmorgan@comcast.net

Hai Tang NIST hai.tang@nist.gov

King Kong Congo, Inc. trhodes@nist.gov

zog zog zog

user3 user3 clement.ridoret@nist.gov

Elizabeth Fong NIST efong@nist.gov

Create a Subgroup

Subgroup Name:

Subgroup Administrator:

Figure 73 Member Area - My Group Display – Add a Subgroup

Note that the “My Group” screen highlights the name of the Group for which the user is the Administrator (i.e. “GroupTest” in this example). Additionally, the Administrator of the Group (or Subgroup) has the capability to “Create a Subgroup” and select an Administrator, using the drop-down list of member names, as shown near the bottom of Figure 73.

To create a new Subgroup under the current Group (or Subgroup), the Administrator enters a Subgroup name in the “Subgroup Name” input-box. Next, the Administrator selects a name of a Group (or Subgroup) Member from the drop-down list labeled “Subgroup Administrator,” as the new Subgroup Administrator. Upon clicking the “Submit” button, the new Subgroup will be created and the person selected assigned as the Subgroup Administrator.

In Figure 74, two Subgroups are shown, each with a different Administrator. These are shown under the “My Subgroup(s)” section in the Figure. Note that the Administrator of the current “GroupTest” is provided capabilities to change or remove (delete) the Administrator of either Subgroup, as well as any members of “GroupTest.”

My Group GroupTest

You are logged in as the Administrator of the group: **GroupTest**.

Default Group Content Access Control Permissions

GroupTest Members **Parent Group Members** **Other Members**

Read

Group Information

Group Name:

Group Description:

My Group Content

[See my group content](#)

My Group Members

Login	Name	Organization	Email	Remove
user4	user4	user4	clement.ridoret@nist.gov	
user5	user5 (Roy Morgan)	NIST ITL, HCSSL Development Team	roysmorgan@comcast.net	
tang	Hai Tang	NIST	hai.tang@nist.gov	
user3	user3	user3	clement.ridoret@nist.gov	

My Subgroup(s)

Subgroup Name	Administrator	Delete	Change Admin
GroupTestSubr1	user4		
GroupTestSubr2	user3		

Add a Member

None

null null null

null null test_date4tgo

user1 user1 clement.ridoret@nist.gov

user2 user2 clement.ridoret@nist.gov

user4 user4 clement.ridoret@nist.gov

Leroy Morganfong HCSSL Testing Team efong@nist.gov

Tom Rhodes NIST trhodes@nist.gov

Roy Morgan NIST rmorgan@nist.gov

null null null

GUEST null null

Clement Ridoret NIST cridoret@nist.gov

Test Test test

test test clemusa@gmail.com

user5 (Roy Morgan) NIST ITL, HCSSL Development Team roysmorgan@comcast.net

Hai Tang NIST hai.tang@nist.gov

King Kong Congo, Inc. trhodes@nist.gov

zog zog zog

user3 user3 clement.ridoret@nist.gov

Elizabeth Fong NIST efong@nist.gov

Create a Subgroup

Subgroup Name:

Subgroup Administrator:

Figure 74 Member Area - My Group Display –Subgroups and Administrators

If the Group Administrator selects the “Change Admin” control, under the “My Subgroup(s)” section, a form is displayed, as shown in Figure 75, “Changing Subgroup Administrator,” that allows selecting the name of a new Subgroup Administrator from the drop-down list. This list contains the names of all Group/Subgroup members. When the “Submit” button is selected, the change is finalized.

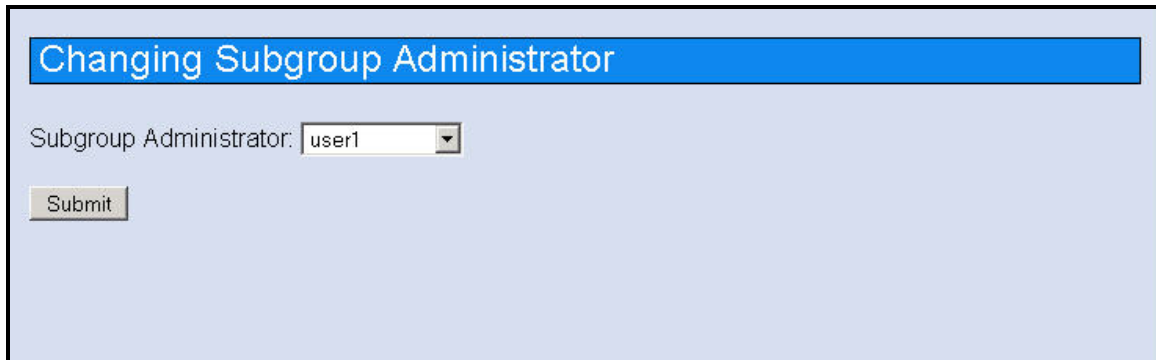

Figure 75 Member Area - My Group Display – Changing Subgroup Administrator

7.5 Removing a Subgroup

The Administrator of a Group or Subgroup may remove any Subgroups that are immediately under their Group or Subgroup. However, before the Subgroup can be removed, all lower-level Subgroups must be removed first. This is to ensure an orderly process in removing of Subgroups, and for the proper disposition of Subgroup content and membership, as described below:

- When a Subgroup is removed, existing Subgroup members continue to remain as members of the next higher-level Subgroup or Group (i.e. parent Subgroup or Group).
- Existing content from the removed Subgroup is now associated with the higher-level Subgroup or Group, but continues to remain under the “ownership” of the content owners as member of the parent Group/Subgroup.
- If the content owner is removed from a Subgroup or Group, the content is transferred to the ownership of the Administrator of the Subgroup or Group.

Note: See, “Appendix C – FAQ, Frequently Asked Questions,” Question # 23, “What happens to my content when I am removed from an HCSL Group or Subgroup, or as a Registered User of the HCSL? And Question # 24, “What happens to the content when a Subgroup or Group is removed?”

To remove a Subgroup, the Administrator of the parent Subgroup or Group performs the following steps:

- The Administrator first ensures that all lower-level Subgroups have been removed by selecting the “Browse Groups” submenu under the “Member Area” or “Search Content” menu, and then reviewing that all lower-level Subgroups, under the Subgroup to be removed, have been deleted.

- The Administrator logs in to their Group or Subgroup and selects the “My Group” submenu under the “Member Area,” menu selection, as shown previously in Figure 48. This will display the “My Group” form, as shown previously in Figure 74.
- On the “My Group” display, Figure 74, the Group Administrator identifies the Subgroup to be removed in the “My Subgroup(s)” section, and then selects the “Delete” button next to that Subgroup to remove it.
- A “Delete Subgroup” message will be displayed, as shown in Figure 76, asking the Administrator if they are sure they want to delete the Subgroup. By selecting the “Delete” button in this message, the Subgroup will be removed from HCSL.
- If an Administrator attempts to remove a Subgroup that has other Subgroups under it, an error message will be displayed saying, “*The subgroup you want to delete must not have any subgroups under it.*”

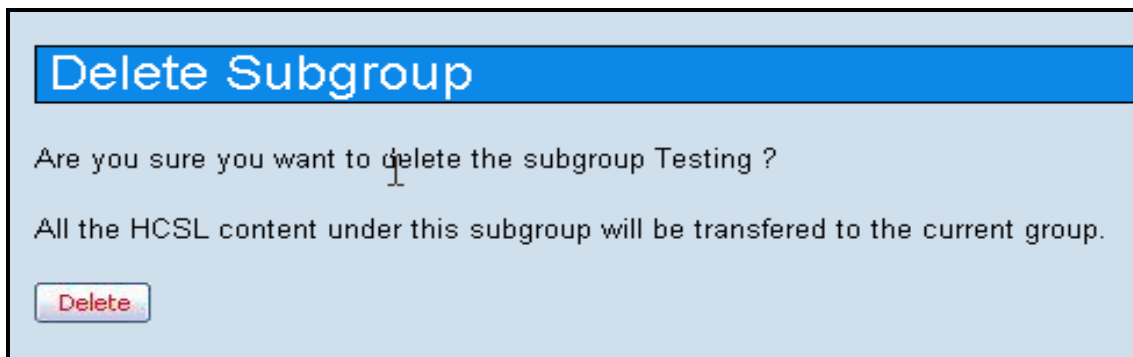

Figure 76 Confirm “Delete a Subgroup” Message

7.6 Removing a Group

In order to remove any Group, all Subgroups under the Group to be removed, must be removed first. The process for removing a Subgroup is described in Section 7.5.

Only the System Administrator can remove an existing Group within HCSL. A Group Administrator should contact the System Administrator to request to have their Group removed. The System Administrator will confirm the request and remove the Group from the HCSL.

When a Group is removed, members of the Group continue to remain as “Registered Users” of HCSL, as members of the Guest Group. However, when a Group is removed, the disposition of Group content depends on whether the Group content owner continues to remain as a “Registered User” of HCSL, as described below:

- When a Group is removed, any remaining Group content remains in the HCSL database under the "ownership" of the content owner, as long as he/she remains as a Registered User of the HCSL. Note that a former Group Administrator may also remain as a Registered User and a content owner.
- If a Registered User, who was a member of a Group that was removed, is also removed from the HCSL Guest Group, their content is automatically transferred to the HCSL Administrator as the new content “owner,” and remains available for other users to access and view in the HCSL. Subsequently, the HCSL

Administrator may transfer this content “ownership” to a member of another Group or Subgroup in HCSL, as required.

Note: See, “Appendix C – FAQ, Frequently Asked Questions,” Question # 23, “What happens to my content when I am removed from an HCSL Group or Subgroup, or as a Registered User of the HCSL?”

8 User Support Menu

The “User Support” menu, shown in the Figure 77 below, provides the following options:

- User Guide - PDF and HTML versions of the User Guide document
- Presentations - HCSL presentations
- FAQ – a list of Frequently Asked Questions about HCSL
- Acronyms and Links - healthcare acronyms and web links (URLs)
- Contact Us - send an email to the HCSL System Administrator

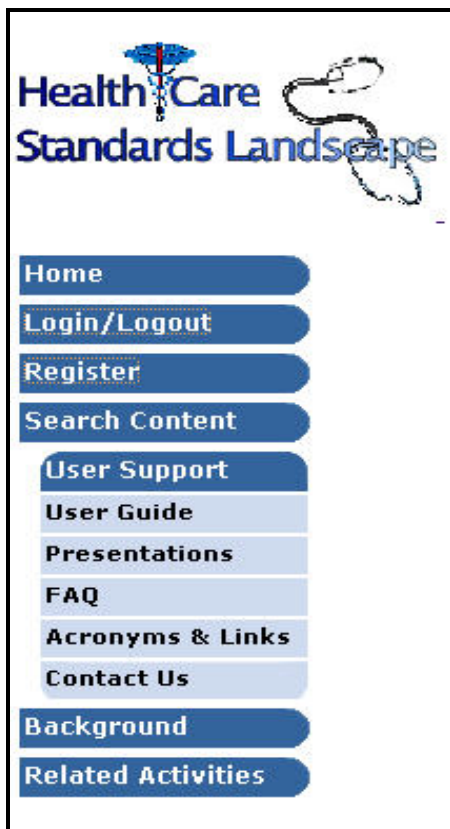

Figure 77 User Support Menus

8.1 User Guide Menu

The HCSL User Guide is this document. It provides information on how to use the HealthCare Standards Landscape capabilities, including administrative functions. It is available in PDF and HTML formats, and may be printed or downloaded by a user.

8.2 Presentations Menu

These are Landscape presentations made to conferences, meetings, or interested groups. Normally presentations are in Power Point format, and may be downloaded and/or viewed in a browser or PowerPoint application.

8.3 FAQ (Frequently Asked Questions) Menu

The FAQ is available by clicking the FAQ button. It is also included as “Appendix C – FAQ, Frequently Asked Questions,” of this document. The FAQ provides explanatory information about Landscape features.

8.4 Acronyms and Links Menu

A list of healthcare and other acronyms is available by clicking the “Acronyms & Links” button. Included, are links to web sites of interest to the healthcare and standards community.

8.5 Contact Us Menu

The “Contact Us” display, shown in Figure 78, allows users to send a message directly to the Landscape Administrator.

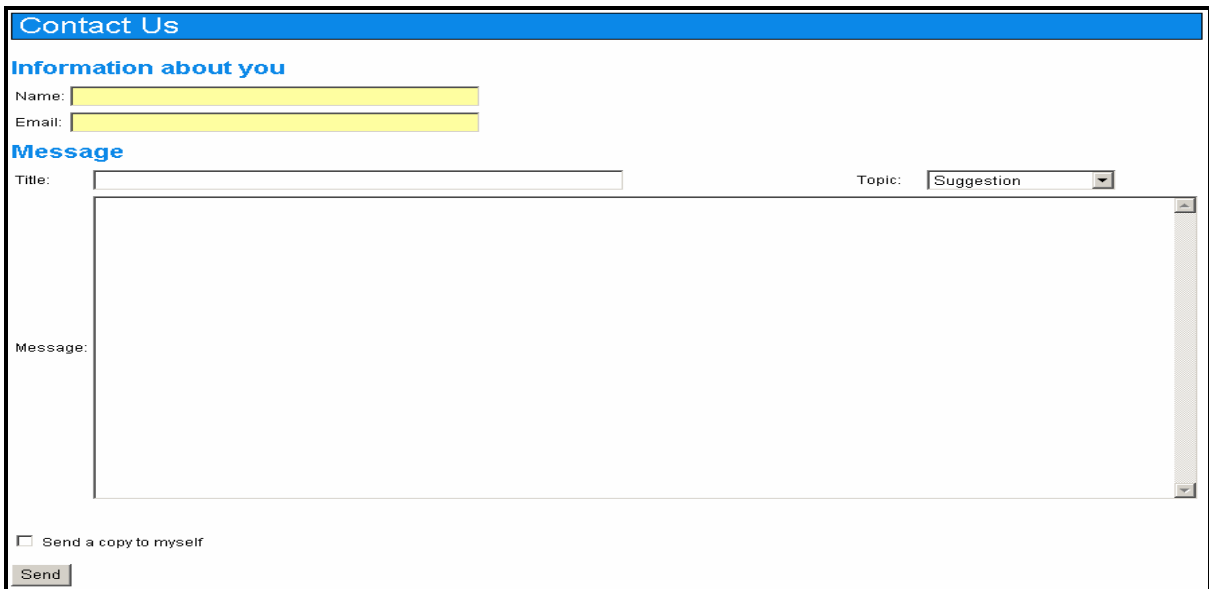

The screenshot shows a web form titled "Contact Us" with a blue header. Below the header, there is a section titled "Information about you" with two yellow input fields for "Name:" and "Email:". Below that is a section titled "Message" with a "Title:" input field, a "Topic:" dropdown menu set to "Suggestion", and a large text area for the message. At the bottom left, there is a checkbox labeled "Send a copy to myself" and a "Send" button.

Figure 78 “Contact Us” Display

The “Topic” drop-down list, shown at the top-right side in Figure 78, has the following choices:

- Bug Report
- Comment
- Information Request
- Suggestion
- Other

Users can select the “Topic” most appropriate for their message.

The “Send a copy to myself” button at the bottom can be used if a user wishes a copy to be sent to their email address, as listed in their HCSL registration form.

9 Background Menu

The “Background” menu provides a brief description of the “Overview” and “Approach” for the Landscape project, as shown in Figure 79 below:

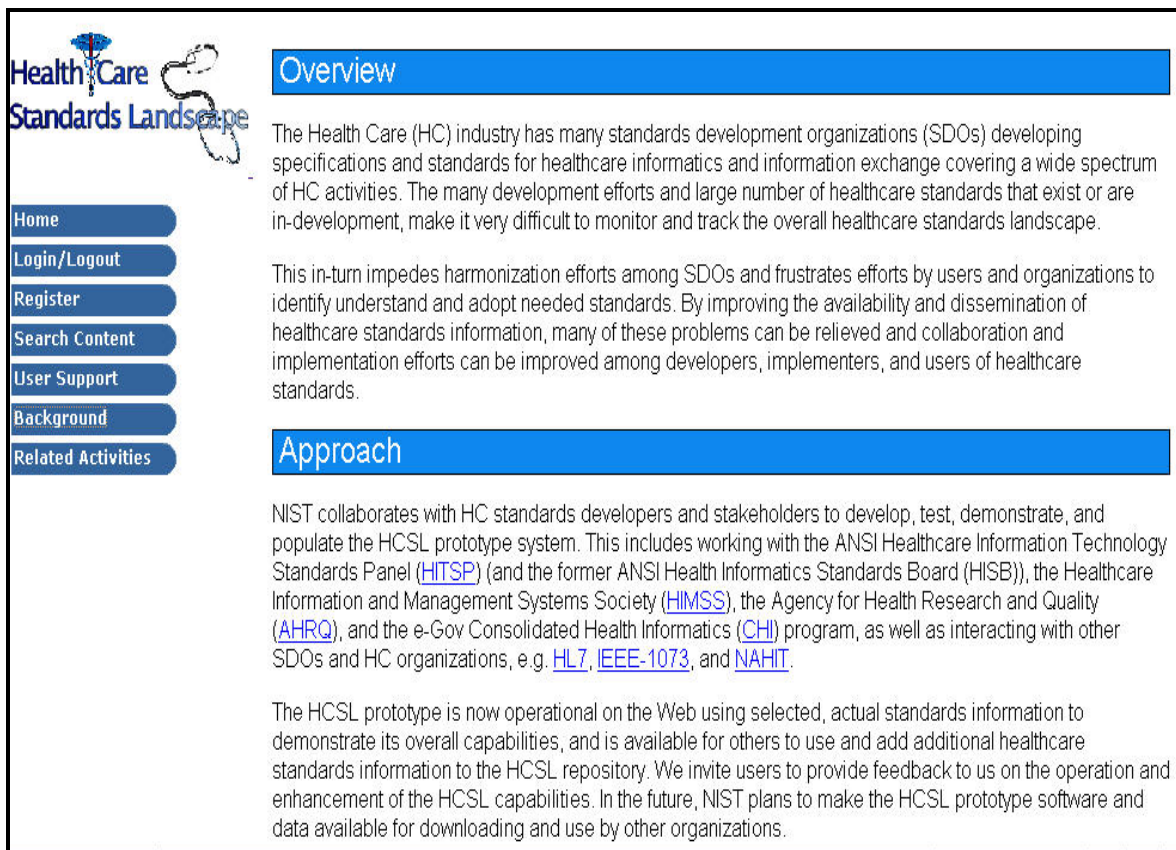

The screenshot shows the 'HealthCare Standards Landscape' website. On the left is a navigation menu with buttons for Home, Login/Logout, Register, Search Content, User Support, Background, and Related Activities. The main content area is titled 'Overview' and 'Approach'. The 'Overview' section describes the complexity of the healthcare standards landscape and the need for harmonization. The 'Approach' section details NIST's collaboration with various organizations like HITSP, HIMSS, AHRQ, and CHI to develop the HCSL prototype system.

Overview

The Health Care (HC) industry has many standards development organizations (SDOs) developing specifications and standards for healthcare informatics and information exchange covering a wide spectrum of HC activities. The many development efforts and large number of healthcare standards that exist or are in-development, make it very difficult to monitor and track the overall healthcare standards landscape.

This in-turn impedes harmonization efforts among SDOs and frustrates efforts by users and organizations to identify understand and adopt needed standards. By improving the availability and dissemination of healthcare standards information, many of these problems can be relieved and collaboration and implementation efforts can be improved among developers, implementers, and users of healthcare standards.

Approach

NIST collaborates with HC standards developers and stakeholders to develop, test, demonstrate, and populate the HCSL prototype system. This includes working with the ANSI Healthcare Information Technology Standards Panel ([HITSP](#)) (and the former ANSI Health Informatics Standards Board (HISB)), the Healthcare Information and Management Systems Society ([HIMSS](#)), the Agency for Health Research and Quality ([AHRQ](#)), and the e-Gov Consolidated Health Informatics ([CHI](#)) program, as well as interacting with other SDOs and HC organizations, e.g. [HL7](#), [IEEE-1073](#), and [NAHIT](#).

The HCSL prototype is now operational on the Web using selected, actual standards information to demonstrate its overall capabilities, and is available for others to use and add additional healthcare standards information to the HCSL repository. We invite users to provide feedback to us on the operation and enhancement of the HCSL capabilities. In the future, NIST plans to make the HCSL prototype software and data available for downloading and use by other organizations.

Figure 79 Background – Overview and Approach

10 Related Activities Menu

The “Related Activities” menu provides access to related activities that are not currently part of the Landscape system, but which were intended to be included in the Landscape at a later time. Currently, two such activities are listed: the “AHRQ Yellow Book,” and “Conformance,” as shown in Figure 80.

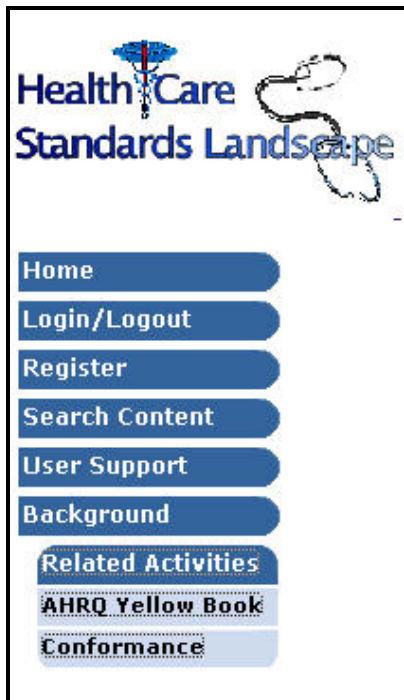

Figure 80 Related Activities Menu

Work on these activities has been suspended at this time. However, brief descriptions of these capabilities are provided below:

10.1 AHRQ Yellow Book Menu

This menu is a placeholder for linking to the “Yellow Book” application. This activity refers to a NIST effort to provide a web-based tool for collecting and publishing information on healthcare standards’ activities that are now published by the Agency for Healthcare Research and Quality (AHRQ), an agency of the U.S. Department of Health and Human Services (DHHS) and sponsor of the Landscape. Currently, this information is published, about quarterly, as a printed report for the healthcare community. This publication is informally referred to as the “Yellow Book” because of its yellow cover page. NIST developed a prototype capability to automate the data entry and publication of this information over the web for use by SDOs and subscribers. However, this work was suspended, and is presented under the Landscape for information only.

10.2 Conformance Menu

This menu links to a demonstration capability developed by NIST to couple Landscape information about healthcare standards' to information on corresponding standards' conformance and testing capabilities. The demonstration capability includes information on several healthcare standards, some of which have been linked to corresponding standards information in the Landscape. This work was suspended, and presented under the Landscape for information only.

11 Summary

This document provides guidance, information, and examples on how to use the functions and capabilities provided by the NIST HealthCare Standards Landscape (HCSL or "Landscape") software and database. The Landscape is accessible over the Internet as a web application, at <http://www.nist.gov/hcsl>. The Landscape tool includes capabilities for searching and publishing information related to healthcare standards, and for administering groups of users and information content in the Landscape. As the Landscape is enhanced and new functionality added, the User Guide will be updated accordingly.

The HCSL system is operational and demonstrates a publicly available web-based capability for finding and publishing information on:

- Health informatics standards and other related documents,
- Associated standards development organizations, implementers, end-user, and organizations that adopt and implement these standards,
- Standards portfolios that organizations have adopted, and
- Links to other healthcare and standards' resources.

The HCSL uses actual healthcare standards' information to demonstrate its capabilities, and is available for users and organizations to search for and add additional information. Use of the Landscape is growing and as additional information is added the value of the HCSL will continue to increase. NIST envisions that the HCSL can become a comprehensive source of health informatics and healthcare standards information that will support standards-based, system development and interoperability needs of the healthcare community and stakeholders.

The design and implementation of this web tool was based upon requirements from many healthcare organizations and stakeholders. Organizations that have provided significant guidance, information, and support to the HCSL include:

- Agency for Health Research and Quality ([AHRQ](#))
- ANSI Healthcare Information Technology Standards Panel ([HITSP](#)) (and the former ANSI Health Informatics Standards Board - HISB)
- Healthcare Information and Management Systems Society ([HIMSS](#))
- National Alliance for Health Information Technology ([NAHIT](#), the "Alliance")

- e-Gov Consolidated Health Informatics ([CHI](#)) program
- American Dental Association ([ADA](#))
- American Telemedicine Association ([ATA](#))
- Health Level Seven ([HL7](#))
- Institute of Electrical and Electronics Engineers - 1073 Standard for Medical Device Communications ([IEEE-1073](#))
- National Council for Prescription Drug Programs ([NCPDP](#))
- And others.

NIST welcomes your comments and suggestions on the Landscape system and on the User Guide, in how we might enhance HCSL capabilities and value. Please send your feedback to the HCSL System Administrator at hsl_admin@nist.gov. Thank you.

12 Appendix A - XML Schemas

XML Schemas are used for the three information content objects used in HCSL: the Document schema, the Organization schema, and the Portfolio schema. These are presented below in both text and graphical formats, respectively:

12.1 The Document Schema

```
<?xml version="1.0" encoding="UTF-8" ?>
<xs:schema elementFormDefault="qualified"
  attributeFormDefault="unqualified"
  xmlns:xs="http://www.w3.org/2001/XMLSchema">
<xs:element name="Document">
  <xs:annotation>
    <xs:documentation>This is the root element of the
      document.</xs:documentation>
  </xs:annotation>
  <xs:complexType>
    <xs:sequence>
      <xs:element name="Name" type="xs:string" />
      <xs:element name="ShortName" type="xs:string"
        minOccurs="0" />
      <xs:element name="AltNames" type="xs:string"
        minOccurs="0" />
      <xs:element name="Abstract" type="xs:string" />
      <xs:element name="Keywords" type="xs:string"
        minOccurs="0" />
      <xs:element name="AvailableAt" type="xs:anyURI"
        minOccurs="0" />
      <xs:element name="DocType" type="docType"
        minOccurs="0" />
      <xs:element name="DocStatus" type="docStatus"
        minOccurs="0" />
      <xs:element name="HCDomain" type="hCDomain"
        minOccurs="0" />
      <xs:element name="Category" type="category"
        minOccurs="0" />
      <xs:element name="OtherInfo" type="xs:string"
        minOccurs="0" />
      <xs:element name="AuthorsEditors"
        type="xs:string" minOccurs="0" />
      <xs:element
        name="IntellectualPropertyInformation"
        type="xs:string" minOccurs="0" />
      <xs:element name="Version" type="xs:string"
        minOccurs="0" />
      <xs:element name="IssueDate" type="xs:string"
        minOccurs="0" />
    </xs:sequence>
  </xs:complexType>
</xs:element>
<xs:simpleType name="docType">
  <xs:restriction base="xs:string">
    <xs:enumeration value="Abstract" />
  </xs:restriction>
</xs:simpleType>
</xs:schema>
```



```
<xs:enumeration value="Acknowledgement/Receipt" />
<xs:enumeration value="Animation" />
<xs:enumeration value="Application" />
<xs:enumeration value="Art Work" />
<xs:enumeration value="Article" />
<xs:enumeration value="Audio" />
<xs:enumeration value="Bibliography" />
<xs:enumeration value="Bill/Invoice" />
<xs:enumeration value="Bill/List of Materials" />
<xs:enumeration value="Book" />
<xs:enumeration value="Brochure/Pamphlet" />
<xs:enumeration value="Business Card" />
<xs:enumeration value="Business Document" />
<xs:enumeration value="Case Study" />
<xs:enumeration value="Certificate" />
<xs:enumeration value="Chart" />
<xs:enumeration value="Charter" />
<xs:enumeration value="Code List" />
<xs:enumeration value="Comment" />
<xs:enumeration value="Compendium" />
<xs:enumeration value="Conference Paper" />
<xs:enumeration value="Contract/Agreement" />
<xs:enumeration value="Data Base/File" />
<xs:enumeration value="Dictionary" />
<xs:enumeration value="Directory" />
<xs:enumeration value="Document" />
<xs:enumeration value="Drawing" />
<xs:enumeration value="E-mail" />
<xs:enumeration value="Encyclopedia" />
<xs:enumeration value="Facsimile/FAX" />
<xs:enumeration value="Figure" />
<xs:enumeration value="File" />
<xs:enumeration value="Form" />
<xs:enumeration value="Graph" />
<xs:enumeration value="Graphic" />
<xs:enumeration value="Guide" />
<xs:enumeration value="Guideline" />
<xs:enumeration value="Halftone" />
<xs:enumeration value="Handbook" />
<xs:enumeration value="Handout" />
<xs:enumeration value="Image" />
<xs:enumeration value="Index" />
<xs:enumeration value="Journal" />
<xs:enumeration value="Law" />
<xs:enumeration value="Legal" />
<xs:enumeration value="Lesson" />
<xs:enumeration value="Letter" />
<xs:enumeration value="Magazine" />
<xs:enumeration value="Map" />
<xs:enumeration value="Memorandum" />
<xs:enumeration value="Message" />
<xs:enumeration value="Model" />
<xs:enumeration value="Movie" />
<xs:enumeration value="Multimedia" />
<xs:enumeration value="Music" />
<xs:enumeration value="News Article" />
<xs:enumeration value="News Release/Report" />
<xs:enumeration value="Newspaper" />
<xs:enumeration value="Not Defined" />
```

```

<xs:enumeration value="Note" />
<xs:enumeration value="Ontology" />
<xs:enumeration value="Other" />
<xs:enumeration value="Painting" />
<xs:enumeration value="Pamphlet" />
<xs:enumeration value="Paper" />
<xs:enumeration value="Photograph" />
<xs:enumeration value="Plan" />
<xs:enumeration value="Policy" />
<xs:enumeration value="Position Statement" />
<xs:enumeration value="Presentation" />
<xs:enumeration value="Proceedings" />
<xs:enumeration value="Proposal" />
<xs:enumeration value="Protocol" />
<xs:enumeration value="Reference" />
<xs:enumeration value="Regulation" />
<xs:enumeration value="Regulation/law" />
<xs:enumeration value="Report" />
<xs:enumeration value="Rule" />
<xs:enumeration value="Schedule" />
<xs:enumeration value="Schema" />
<xs:enumeration value="Script" />
<xs:enumeration value="Shipping List" />
<xs:enumeration value="Software" />
<xs:enumeration value="Sound" />
<xs:enumeration value="Source Code" />
<xs:enumeration value="Specification" />
<xs:enumeration value="Specification/standard" />
<xs:enumeration value="Spreadsheet" />
<xs:enumeration value="Standard" />
<xs:enumeration value="Stylesheet" />
<xs:enumeration value="Summary" />
<xs:enumeration value="Table" />
<xs:enumeration value="Taxonomy" />
<xs:enumeration value="Telegram" />
<xs:enumeration value="Template" />
<xs:enumeration value="Thesaurus" />
<xs:enumeration value="Tutorial" />
<xs:enumeration value="Unknown" />
<xs:enumeration value="Video" />
<xs:enumeration value="Vocabulary List" />
<xs:enumeration value="Vocal (Human voice)" />
<xs:enumeration value="Web Link" />
<xs:enumeration value="Web Page" />
</xs:restriction>
</xs:simpleType>
<xs:simpleType name="docStatus">
  <xs:restriction base="xs:string">
    <xs:enumeration value="Active" />
    <xs:enumeration value="Approved" />
    <xs:enumeration value="Approved and published" />
    <xs:enumeration value="At Ballot" />
    <xs:enumeration value="Deprecated" />
    <xs:enumeration value="Draft" />
    <xs:enumeration value="Draft standard for trial use" />
    <xs:enumeration value="Final Draft" />
    <xs:enumeration value="In-development" />
    <xs:enumeration value="Not Yet Approved" />
  </xs:restriction>
</xs:simpleType>

```

```

    <xs:enumeration value="Published" />
    <xs:enumeration value="Recommendation" />
    <xs:enumeration value="Superceded" />
    <xs:enumeration value="Unavailable" />
    <xs:enumeration value="Under-review" />
    <xs:enumeration value="Unknown" />
    <xs:enumeration value="Withdrawn" />
  </xs:restriction>
</xs:simpleType>
<xs:simpleType name="hCDomain">
  <xs:restriction base="xs:string">
    <xs:enumeration value="Accounting/Billing" />
    <xs:enumeration value="Administration/Management" />
    <xs:enumeration value="Alternative Medicine" />
    <xs:enumeration value="Billing (HIPAA)" />
    <xs:enumeration value="Biology" />
    <xs:enumeration value="Biomedicine" />
    <xs:enumeration value="Biotechnology" />
    <xs:enumeration value="Cardiovascular" />
    <xs:enumeration value="Chemicals (UMLS)" />
    <xs:enumeration value="Chemicals - medications" />
    <xs:enumeration value="Chemicals - non-medicine" />
    <xs:enumeration value="Chemistry" />
    <xs:enumeration value="Claims/Payment" />
    <xs:enumeration value="Clinical" />
    <xs:enumeration value="Cytology" />
    <xs:enumeration value="Demographics" />
    <xs:enumeration value="Dentistry" />
    <xs:enumeration value="Disability (ICF)" />
    <xs:enumeration value="Disease Prevention and
      Control" />
    <xs:enumeration value="Education" />
    <xs:enumeration value="Encounters" />
    <xs:enumeration value="Entomology" />
    <xs:enumeration value="Environmental" />
    <xs:enumeration value="Environmental Health" />
    <xs:enumeration value="Epidemiology" />
    <xs:enumeration value="Ethnology" />
    <xs:enumeration value="Etiology" />
    <xs:enumeration value="Financial" />
    <xs:enumeration value="Forensics" />
    <xs:enumeration value="Gastroenterology" />
    <xs:enumeration value="General Practice" />
    <xs:enumeration value="Genes and Proteins" />
    <xs:enumeration value="Genetic Research" />
    <xs:enumeration value="Genetics" />
    <xs:enumeration value="Gerontology" />
    <xs:enumeration value="Gynecology" />
    <xs:enumeration value="Health Informatics" />
    <xs:enumeration value="Health Information" />
    <xs:enumeration value="Hematology" />
    <xs:enumeration value="History and Physical" />
    <xs:enumeration value="Hospice" />
    <xs:enumeration value="Immunizations" />
    <xs:enumeration value="Insurance" />
    <xs:enumeration value="Interventions" />
    <xs:enumeration value="Laboratory" />
    <xs:enumeration value="Laboratory Test/Result" />
    <xs:enumeration value="Library Services" />
  </xs:restriction>
</xs:simpleType>

```

```

<xs:enumeration value="Medical Devices" />
<xs:enumeration value="Medical Imaging" />
<xs:enumeration value="Medical Research" />
<xs:enumeration value="Medical Supplies" />
<xs:enumeration value="Medications" />
<xs:enumeration value="Mental Health" />
<xs:enumeration value="Messaging" />
<xs:enumeration value="Multimedia" />
<xs:enumeration value="Neurology" />
<xs:enumeration value="None" />
<xs:enumeration value="Nursing" />
<xs:enumeration value="Obstetrics" />
<xs:enumeration value="Occupational Medicine" />
<xs:enumeration value="Oncology" />
<xs:enumeration value="Ophtalmology" />
<xs:enumeration value="Orthopedic" />
<xs:enumeration value="Osteopathy" />
<xs:enumeration value="Other" />
<xs:enumeration value="Parasitology" />
<xs:enumeration value="Pathology" />
<xs:enumeration value="Patient Care" />
<xs:enumeration value="Patient Demographics" />
<xs:enumeration value="Patient Record" />
<xs:enumeration value="Periodontics" />
<xs:enumeration value="Pharmacy" />
<xs:enumeration value="Physics" />
<xs:enumeration value="Physiology" />
<xs:enumeration value="Plastic Surgery" />
<xs:enumeration value="Policy, Regulation,
    Guidelines" />
<xs:enumeration value="Population Health" />
<xs:enumeration value="Prenatal" />
<xs:enumeration value="Procedures" />
<xs:enumeration value="Provider" />
<xs:enumeration value="Psychiatry" />
<xs:enumeration value="Psychology" />
<xs:enumeration value="Public Health" />
<xs:enumeration value="Pulmonary" />
<xs:enumeration value="Research" />
<xs:enumeration value="Research Programs" />
<xs:enumeration value="Security/Privacy" />
<xs:enumeration value="Specifications/Standards" />
<xs:enumeration value="Supplies" />
<xs:enumeration value="Surgery" />
<xs:enumeration value="Telehealth" />
<xs:enumeration value="Telemedicine" />
<xs:enumeration value="Toxicogenomics" />
<xs:enumeration value="Toxicology" />
<xs:enumeration value="Training" />
<xs:enumeration value="Urology" />
<xs:enumeration value="Veterinary" />
<xs:enumeration value="Virology" />
</xs:restriction>
</xs:simpleType>
<xs:simpleType name="category">
  <xs:restriction base="xs:string">
    <xs:enumeration value="Electronic Health Records" />
    <xs:enumeration value="Terminology" />
  </xs:restriction>
</xs:simpleType>

```

```

<xs:enumeration value="Patient/Provider Identifiers"
/>
<xs:enumeration value="Security" />
<xs:enumeration value="Auto-ID and Bar Code" />
<xs:enumeration value="Quality
Improvement/Management" />
<xs:enumeration value="Standards
supporting/promoting organization" />
<xs:enumeration value="ePrescription/CPOE/Medication
Administration" />
<xs:enumeration value="Message Format/Electronic
Data Exchange" />
<xs:enumeration value="Federally adopted
standards/CHI" />
<xs:enumeration value="Claims processing/transaction
standards" />
<xs:enumeration value="Health Data Cards/Smart
Cards" />
<xs:enumeration value="Other" />
<xs:enumeration value="Wireless" />
<xs:enumeration value="Imaging" />
<xs:enumeration value="Minimum Data Sets" />
<xs:enumeration value="Supply Chain" />
</xs:restriction>
</xs:simpleType>
</xs:schema>

```

The Document schema is shown here in graphical form.

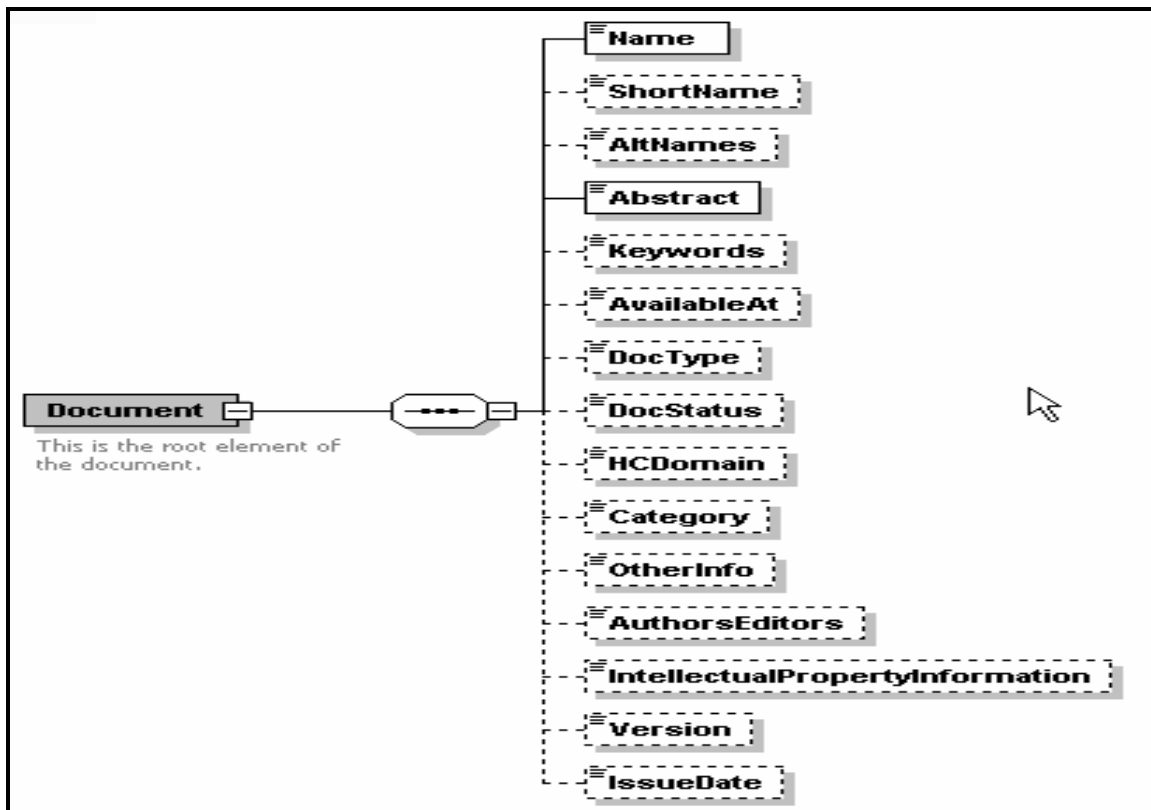

Figure 81 XML Schema for Document

12.2 The Organization Schemaⁱⁱⁱ

```
<?xml version="1.0" encoding="UTF-8" ?>
<xs:schema elementFormDefault="qualified"
  attributeFormDefault="unqualified"
  xmlns:xs="http://www.w3.org/2001/XMLSchema">
  <xs:element name="Entity">
    <xs:annotation>
      <xs:documentation>This is the root
        element</xs:documentation>
    </xs:annotation>
    <xs:complexType>
      <xs:sequence>
        <xs:element name="Name" type="xs:string" />
        <xs:element name="ShortName" type="xs:string"
          minOccurs="0" />
        <xs:element name="AltNames" type="xs:string"
          minOccurs="0" />
        <xs:element name="Mission" type="xs:string"
          minOccurs="0" />
        <xs:element name="Website" type="xs:anyURI"
          minOccurs="0" />
        <xs:element name="EntityType" type="entityType"
          minOccurs="0" />
        <xs:element name="HCDomain" type="hCDomain"
          minOccurs="0" maxOccurs="unbounded" />
        <xs:element name="Category" type="category"
          minOccurs="0" />
        <xs:element name="Scope" type="xs:string"
          minOccurs="0" />
        <xs:element name="Background" type="xs:string"
          minOccurs="0" />
        <xs:element name="Charter" type="xs:string"
          minOccurs="0" />
        <xs:element name="Goals" type="xs:string"
          minOccurs="0" />
        <xs:element name="Objectives" type="xs:string"
          minOccurs="0" />
        <xs:element name="Description" type="xs:string"
          minOccurs="0" />
        <xs:element name="Membership" type="xs:string"
          minOccurs="0" />
        <xs:element name="Leadership" type="xs:string"
          minOccurs="0" />
        <xs:element name="TargetAudiences"
          type="xs:string" minOccurs="0" />
      </xs:sequence>
    </xs:complexType>
  </xs:element>
</xs:schema>
```

ⁱⁱⁱ Note that the element name used for an organization is “Entity.” This term was used early in the development of the HCSL and remains solely in use within the Schema and in the HCSL database and associated software code.

```

    <xs:element name="WorkItems" type="xs:string"
      minOccurs="0" />
    <xs:element name="ContactInfo" type="contactInfo"
      minOccurs="0" />
  </xs:sequence>
</xs:complexType>
</xs:element>
<xs:simpleType name="entityType">
  <xs:restriction base="xs:string">
    <xs:enumeration value="Academic" />
    <xs:enumeration value="Collaborative" />
    <xs:enumeration value="Consortia" />
    <xs:enumeration value="Corporate" />
    <xs:enumeration value="Council" />
    <xs:enumeration value="Educational" />
    <xs:enumeration value="For-profit" />
    <xs:enumeration value="Initiative" />
    <xs:enumeration value="Local Government" />
    <xs:enumeration value="Manufacturing" />
    <xs:enumeration value="Military" />
    <xs:enumeration value="Non-profit" />
    <xs:enumeration value="Professional Society" />
    <xs:enumeration value="SDO" />
    <xs:enumeration value="State Government" />
    <xs:enumeration value="Trade Association" />
    <xs:enumeration value="Tribal Government" />
    <xs:enumeration value="US Government" />
  </xs:restriction>
</xs:simpleType>
<xs:simpleType name="hCDomain">
  <xs:restriction base="xs:string">
    <xs:enumeration value="Accounting/Billing" />
    <xs:enumeration value="Administration/Management" />
    <xs:enumeration value="Alternative Medicine" />
    <xs:enumeration value="Billing (HIPAA)" />
    <xs:enumeration value="Biology" />
    <xs:enumeration value="Biomedicine" />
    <xs:enumeration value="Biotechnology" />
    <xs:enumeration value="Cardiovascular" />
    <xs:enumeration value="Chemicals (UMLS)" />
    <xs:enumeration value="Chemicals - medications" />
    <xs:enumeration value="Chemicals - non-medicine" />
    <xs:enumeration value="Chemistry" />
    <xs:enumeration value="Claims/Payment" />
    <xs:enumeration value="Clinical" />
    <xs:enumeration value="Cytology" />
    <xs:enumeration value="Demographics" />
    <xs:enumeration value="Dentistry" />
    <xs:enumeration value="Disability (ICF)" />
    <xs:enumeration value="Disease Prevention and Control" />
  </xs:restriction>
</xs:simpleType>

```

<xs:enumeration value="Education" />
<xs:enumeration value="Encounters" />
<xs:enumeration value="Entomology" />
<xs:enumeration value="Environmental" />
<xs:enumeration value="Environmental Health" />
<xs:enumeration value="Epidemiology" />
<xs:enumeration value="Ethnology" />
<xs:enumeration value="Etiology" />
<xs:enumeration value="Financial" />
<xs:enumeration value="Forensics" />
<xs:enumeration value="Gastroenterology" />
<xs:enumeration value="General Practice" />
<xs:enumeration value="Genes and Proteins" />
<xs:enumeration value="Genetic Research" />
<xs:enumeration value="Genetics" />
<xs:enumeration value="Gerontology" />
<xs:enumeration value="Gynecology" />
<xs:enumeration value="Health Informatics" />
<xs:enumeration value="Health Information" />
<xs:enumeration value="Hematology" />
<xs:enumeration value="History and Physical" />
<xs:enumeration value="Hospice" />
<xs:enumeration value="Immunizations" />
<xs:enumeration value="Insurance" />
<xs:enumeration value="Interventions" />
<xs:enumeration value="Laboratory" />
<xs:enumeration value="Laboratory Test/Result" />
<xs:enumeration value="Library Services" />
<xs:enumeration value="Medical Devices" />
<xs:enumeration value="Medical Imaging" />
<xs:enumeration value="Medical Research" />
<xs:enumeration value="Medical Supplies" />
<xs:enumeration value="Medications" />
<xs:enumeration value="Mental Health" />
<xs:enumeration value="Messaging" />
<xs:enumeration value="Multimedia" />
<xs:enumeration value="Neurology" />
<xs:enumeration value="None" />
<xs:enumeration value="Nursing" />
<xs:enumeration value="Obstetrics" />
<xs:enumeration value="Occupational Medicine" />
<xs:enumeration value="Oncology" />
<xs:enumeration value="Ophtalmology" />
<xs:enumeration value="Orthopedic" />
<xs:enumeration value="Osteopathy" />
<xs:enumeration value="Other" />
<xs:enumeration value="Parasitology" />
<xs:enumeration value="Pathology" />
<xs:enumeration value="Patient Care" />
<xs:enumeration value="Patient Demographics" />
<xs:enumeration value="Patient Record" />

```

<xs:enumeration value="Periodontics" />
<xs:enumeration value="Pharmacy" />
<xs:enumeration value="Physics" />
<xs:enumeration value="Physiology" />
<xs:enumeration value="Plastic Surgery" />
<xs:enumeration value="Policy, Regulation, Guidelines" />
<xs:enumeration value="Population Health" />
<xs:enumeration value="Prenatal" />
<xs:enumeration value="Procedures" />
<xs:enumeration value="Provider" />
<xs:enumeration value="Psychiatry" />
<xs:enumeration value="Psychology" />
<xs:enumeration value="Public Health" />
<xs:enumeration value="Pulmonary" />
<xs:enumeration value="Research" />
<xs:enumeration value="Research Programs" />
<xs:enumeration value="Security/Privacy" />
<xs:enumeration value="Specifications/Standards" />
<xs:enumeration value="Supplies" />
<xs:enumeration value="Surgery" />
<xs:enumeration value="Telehealth" />
<xs:enumeration value="Telemedicine" />
<xs:enumeration value="Toxicogenomics" />
<xs:enumeration value="Toxicology" />
<xs:enumeration value="Training" />
<xs:enumeration value="Urology" />
<xs:enumeration value="Veterinary" />
<xs:enumeration value="Virology" />
</xs:restriction>
</xs:simpleType>
<xs:simpleType name="category">
  <xs:restriction base="xs:string">
    <xs:enumeration value="Electronic Health Records" />
    <xs:enumeration value="Terminology" />
    <xs:enumeration value="Patient/Provider Identifiers" />
    <xs:enumeration value="Security" />
    <xs:enumeration value="Auto-ID and Bar Code" />
    <xs:enumeration value="Quality
      Improvement/Management" />
    <xs:enumeration value="Standards supporting/promoting
      organization" />
    <xs:enumeration value="ePrescription/CPOE/Medication
      Administration" />
    <xs:enumeration value="Message Format/Electronic Data
      Exchange" />
    <xs:enumeration value="Federally adopted
      standards/CHI" />
    <xs:enumeration value="Claims processing/transaction
      standards" />
    <xs:enumeration value="Health Data Cards/Smart Cards"
      />
    <xs:enumeration value="Other" />
  </xs:restriction>
</xs:simpleType>

```

```

<xs:enumeration value="Wireless" />
<xs:enumeration value="Imaging" />
<xs:enumeration value="Minimum Data Sets" />
<xs:enumeration value="Supply Chain" />
</xs:restriction>
</xs:simpleType>
<xs:complexType name="contactInfo">
  <xs:sequence>
    <xs:element name="Name" minOccurs="0" />
    <xs:element name="Address" minOccurs="0" />
    <xs:element name="Email" minOccurs="0" />
    <xs:element name="Phone" minOccurs="0" />
  </xs:sequence>
</xs:complexType>
</xs:schema>

```

The Organization (“Entity”) schema is shown here in graphical form.

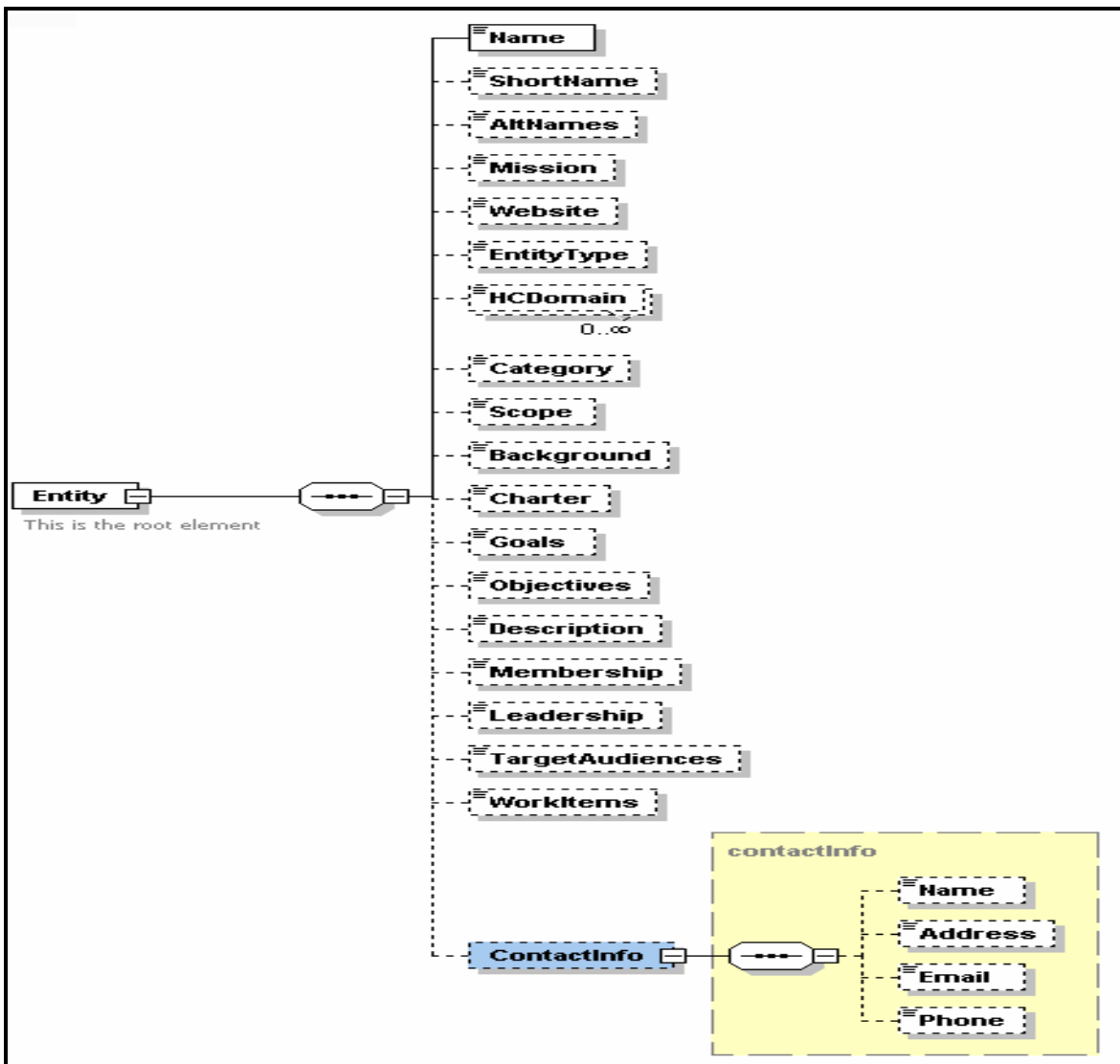

Figure 82 XML Schema for Organization (“Entity”)

12.3 The Portfolio Schema

```
<?xml version="1.0" encoding="UTF-8" ?>
<xs:schema elementFormDefault="qualified"
  attributeFormDefault="unqualified"
  xmlns:xs="http://www.w3.org/2001/XMLSchema">
  <xs:element name="Portfolio">
    <xs:annotation>
      <xs:documentation>This is the root
        element.</xs:documentation>
    </xs:annotation>
    <xs:complexType>
      <xs:sequence>
        <xs:element name="Name" type="xs:string" />
        <xs:element name="Description" type="xs:string" />
        <xs:element name="TargetAudiences"
          type="xs:string" />
        <xs:element name="AvailableAt" type="xs:anyURI" />
      </xs:sequence>
    </xs:complexType>
  </xs:element>
</xs:schema>
```

The Portfolio schema is shown here in graphical form.

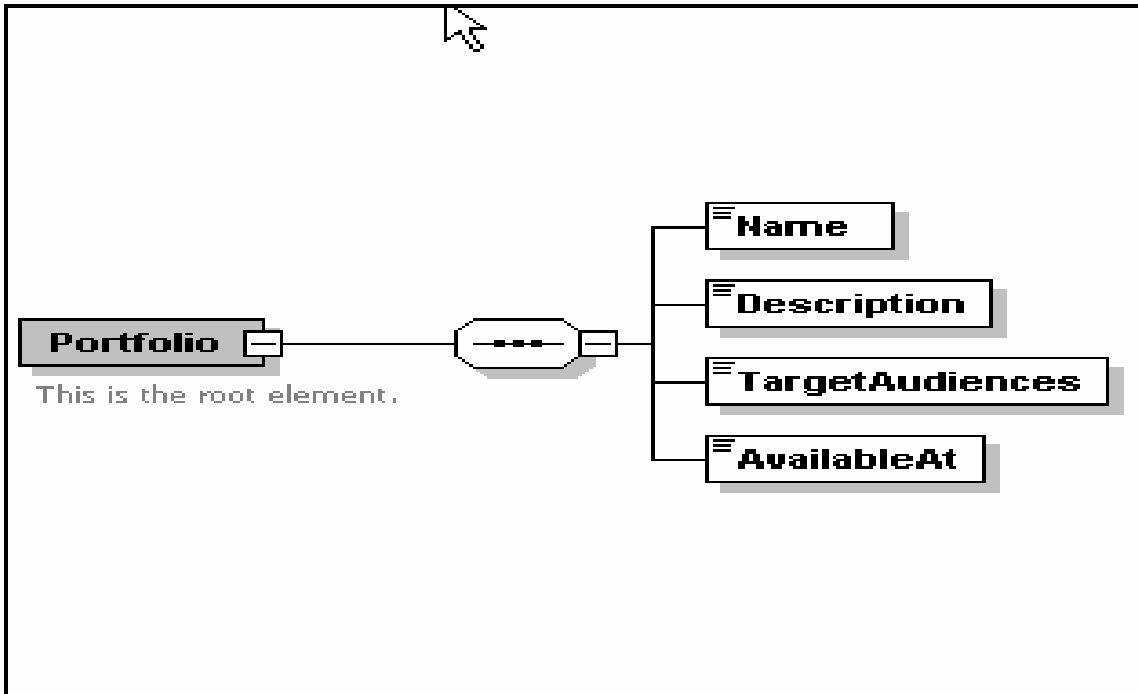

Figure 83 XML Schema for Portfolio

13 Appendix B - Glossary

The Glossary describes key terms used in this document. Further information about each term may be gained from the Landscape itself and especially from the web links given for any term that may be in the Acronyms section of the Landscape (See Section 8.4).

Term	Description
Anonymous User (AU)	A non-registered user of the Landscape.
Content	Data added to the HCSL by users describing Documents, Organizations, Portfolios, or Relationships; instances of an HCSL Object.
Content Permissions	Access controls over Content, i.e. controls over who may view, add, modify, or delete content, and add relationships between HCSL Content.
Data Field	Named elements of an object used to contain data.
Document Object	An HCSL Object used to describe information about a particular type of document, e.g. standard, regulation, report, etc.
Enumerated Values	A set of allowed values defined for a data field.
GA	Group Administrator.
GM	Group Member.
Group	A named reference for an organization of members and content.
Group Administrator	A person registered in HCSL and designated by the System Administrator to have responsibility for management of an HCSL Group, including membership, content permissions, Subgroups, and designation of Subgroup administrators.
Group Member	A registered user of HCSL who is included as a member of a Group by the Group Administrator.
GU	Guest User.
Guest User (GU)	A registered user of HCSL and a member only of the Guest Group, who can browse HCSL data, join a Group, or create a new Group, but not add or manage content in the Landscape.
HCSL	HealthCare Standards Landscape.
Indexed Data Field	A data field used as an index to search and find objects in the HCSL with a matching index value. In HCSL, the data fields “Document Type,” “Document Status,” “HealthCare Domain,” and “Organization Type” are indexed data fields, which have a set of specified values (enumerated values).
Information Model	A representation of the structure and type of information that may be stored in the HCSL.
Information Object	A structured record, containing data fields and values, having a unique identifier; often referred to simply as an HCSL Object”.
Keyword	One to several terms used to describe topics or areas that are relevant to an HCSL Document. Keywords may be used to search for HCSL Documents that contain the particular keywords.
Landscape	An alias referring to the NIST Health Care Standards Landscape (HCSL) system and/or project.

(Login) Username	A designation used by a Registered User to login to the HCSL, which is a unique within the HCSL system.
(Login) Password	A secret designation specified by a User that is used to login as a Registered User to the HCSL.
NIST	National Institute of Standards and Technology.
Object Type	An object corresponding to a particular type of HCSL schema. HCSL currently has three types of objects and schemas: Document, Organization, and, Portfolio.
Organization Object	An HCSL Object used to describe information about a particular type of organization, e.g. SDO, government agency, company, etc.
Portfolio Object	An HCSL Object used to describe information about a collection of documents, typically standards that an organization may have adopted, uses, or developed.
Registered User	A user registered with the HCSL system who is a member of the Guest Group, and a member of zero or more other Groups; a Guest User, part of the “Guest” Group, who may also be a member of, or join, one or more other Groups. A Registered User not assigned to any Group beside the Guest Group, may browse HCSL data, join or create a Group, but not add or manage content.
Repository	The data base containing HCSL Objects (i.e. content).
Relationship	A named, type of relationship between two HCSL information objects. Relationships can be made between any type of HCSL Objects, e.g. Document-to-Document, Document-to-Organization, Document-to-Portfolio, etc.
Relationship Object	An HCSL Object used to describe information about a relationship or relationship between two HCSL Objects.
RU	Registered User.
SA	System Administrator for the HCSL.
Schema	A template defining the allowable structure and content of an object (HCSL Objects are defined by XML Schemas).
Search string	A pattern of text characters used to search and find HCSL Objects having that pattern of characters within the name field of the Objects (i.e., name of the Document, Organization, or Portfolio), or within the keywords of Document Objects.
SG	Subgroup.
SGA	Subgroup Administrator.
SGM	Subgroup Member.
Subgroup	A named reference for an organization of members and content within a parent Group or Subgroup; a hierarchically subordinate Subgroup under a parent group or subgroup.
Subgroup Administrator	A person who is a member of a Group, or parent Subgroup, and designated by the Group/Subgroup Administrator to have responsibility for overall management of an HCSL Subgroup, including membership, content permissions, subordinate Subgroups, and designation of their administrators.
Subgroup Member	A member of a Group, or parent Subgroup, assigned as a member of a Subgroup under the Group/Subgroup.

System Administrator	A person having the authority and responsibility for overall management of the HCSL system and its operations.
User	A person who uses the Landscape to browse, add and/or manage HCSL content, or Groups/Subgroups in the HCSL system.

14 Appendix C – FAQ, Frequently Asked Questions

1. [What does 'HCSL' mean?](#)
2. [What is the HCSL?](#)
3. [Where is the HCSL located?](#)
4. [What is the purpose of the HCSL?](#)
5. [Who may use the HCSL?](#)
6. [How can I register with the HCSL?](#)
7. [What type of health care information does the HCSL contain?](#)
9. [Does the HCSL contain actual health informatic standards?](#)
8. [What is a 'Portfolio'?](#)
10. [How can I browse or search for information in the HCSL?](#)
11. [How can I add new information into the HCSL?](#)
12. [How can I update or delete information in the HCSL?](#)
13. [What are 'Relationships' and how are they used?](#)
14. [How can Relationships between HCSL objects be used for searching?](#)
15. [How are Relationships made between HCSL objects?](#)
16. [How can Relationships for an object be viewed?](#)
17. [Can the Relationships for an object be changed or deleted?](#)
18. [When I view a Document or Organization object, I notice that its 'HealthCare Domains' are displayed as hot-links. What is the significance of these hot-links?](#)
19. [What are HCSL Groups and Sub-Groups?](#)
20. [What is the purpose of having HCSL Groups and Sub-Groups?](#)
21. [How do I establish an HCSL Group or Sub-Group?](#)
22. [How can I join or leave an HCSL Group or Sub-Group?](#)
23. [What happens to my content when I am removed from an HCSL Group or Sub-Group, or as a Registered User of the HCSL?](#)
24. [What happens to the content when a Subgroup or Group is removed?](#)
25. [What type of access controls does the HCSL provide?](#)
26. [What is the current information model and how is it represented in HCSL?](#)
27. [Can the HCSL information model be extended and/or modified?](#)
28. [What software and hardware are needed to access the HCSL?](#)
29. [How is the current HCSL implemented?](#)
30. [How can I submit comments or suggest changes or enhancements to the HCSL?](#)
31. [Who should I contact for further information about the HCSL?](#)

1. What does HCSL mean?

HCSL stands for "Health Care Standards Landscape" often referred to as the "Landscape."

2. What is the HCSL?

The HCSL is a) a NIST project to develop and demonstrate a Web-based repository of information on health care standards, standards development organizations, organizations which adopt and use these standards, and other relevant health care standards information; and, b) the HCSL refers to the actual online repository containing health care standards information that can be accessed over the Web.

3. Where is it located?

The prototype HCSL implementation is hosted on a public Server at NIST, and may be accessed using either <http://www.nist.gov/hcsl> or <http://hcsl.sdct.nist.gov> as the URL in a web browser.

4. What is the purpose of the HCSL?

The HCSL prototype is intended to demonstrate and provide a web-based resource for publishing and finding information on:

- *health informatics information, healthcare standards, and other related information*
- *healthcare standards' development organizations (SDOs), standards implementers, and end-user organizations and facilities that adopt and use these standards*
- *standards portfolios or profiles that organizations have developed or adopted*
- *links to other health informatics and healthcare information resources*

The current HCSL prototype contains a sample of such information to demonstrate its capabilities. However, it is available for users and organizations to add additional information to the HCSL database that will enhance its usefulness to all stakeholders. Eventually, NIST envisions that the HCSL will become a comprehensive resource of relevant health informatics and healthcare information for the wider community of healthcare stakeholders and public.

5. Who may use the HCSL?

Anyone may access the HCSL to search for and view information. Users who are not registered in the HCSL are considered "Guests" and may browse or search the repository, without having to login with a User-Name and Password. However, they cannot add, delete, or change HCSL content, or make relationships among any content. Registered users log in using their User Name and Password, and may join one or more HCSL Groups (described below) to become members of a Group. Group members may search for content, add new content, and modify or delete content that they submitted or "own." Group

members may also make Relationship among HCSL content (see FAQ #13), and change their User Name or Password.

6. How can I register with the HCSL?

Anyone may register with the HCSL by clicking the registration link on the HCSL Welcome page and completing the requested information on the displayed form. A registered user may login to the HCSL, with their User Name and Password and can join one or more Groups, where they may add and manage their content within their Group(s).

7. What type of health care information does the HCSL contain?

Currently, the HCSL contains information about healthcare documents (e.g. specifications and standards, regulations and policy, reports, etc), information about organizations involved with healthcare, such as those developing or using healthcare standards, and information about standards "portfolios" or profiles (further described below) that have been developed or are used by specific organizations (see FAQ #26 also).

8. Does the HCSL contain actual health informatic standards?

No, the HCSL contains information about health informatics standards, on organizations involved with developing, implementing, or using health informatics standards, and on the portfolios' of standards adopted or used by an organization. But, the HCSL does not include the actual standards themselves. However, in most cases, the HCSL provides web links (URLs) to relevant standards development organizations, or to sites where standards may be found or ordered.

9. What is a "Portfolio"?

In the HCSL, a Portfolio is used to describe a collection of documents, typically standards, which an organization has either developed, adopted for use, or implemented within their organization. A Portfolio enables users to quickly see which standards have been developed, adopted or are being used by an organization as part of their current Portfolio of standards. For example, the Portfolio for the Consolidate Health Informatics (CHI) initiative and the Connecting-for-Health (C-f-H) collaborative both include HL7 Messaging, DICOM, and LOINC in their Portfolio of adopted standards. Similarly, the Portfolio for the HL7 healthcare standards development organization includes HL7 Messaging, Clinical Document Architecture (CDA), CCOW, and the Arden Syntax, among other standards that HL7 has developed. A Portfolio object may also include links (i.e. URLs) to the specified documents.

10. How can I browse or search for information in the HCSL?

By selecting **Search Content** in the HCSL Menu, a user can browse or search the HCSL Repository for information on **Documents, Organizations, or Portfolios** using one of several different search methods:

1. by using selected search terms and values (Boolean search),
2. by specifying a search-string (text) to match the name of the object, or to match one or more of its keywords,
3. by selecting a Relationship to find items having that Relationship between them

Method 1 - Boolean Search:

The HCSL indexes certain data elements that may be used as "search-terms" to find specific content in the HCSL database. These search-terms, together with their enumerated values, may be used as search criteria in a Boolean query to find content that meets the specified search criteria.

For **Documents**, HCSL indexes the data elements:

- Document Type
- Document Status
- HealthCare Domain

For **Organizations**, HCSL indexes the data elements:

- Organization Type
- HealthCare Domain

Each indexed element (i.e. search-term) has a defined set of enumerated values that may be selected (from drop down lists) to search for content containing the selected element and value(s). The indexed elements are then used with one of the Boolean operators, **AND** or **OR**, to form a **Boolean Query**. For example, to find Documents in HCSL that are "**published standards related to healthcare messaging**", the user would select the values: **a) Specification/standard** from the drop-down list for **Document Type**; **b) Published** from the list for **Document Status**; and, **c) Messaging** from the list for **HealthCare Domain**, and then selecting the **Search (method 1)** button to begin the search.

By using the default value of **All** for the various search terms, and selecting **Search**, a list of all **Documents, Organizations, or Portfolios** can be displayed. A user may then select an item in this list to view its data or content.

Note that for any search term, **multiple values** may be selected from the drop-down lists and used in the query by holding the **control-key (ctl)** down while making selections from a list. Thus, in the previous example, a user could find all "published or draft" standards relating to messaging by using the "ctl" key to select both **Draft** and **Published** from the list for **Document Status**.

When multiple values for a search term are used in a query, by default, they form an "**OR'd**" expression of values that are used in the search. Hence, in the previous example, selecting both **Draft** and **Published** from the list for

Document Status, will result in all HCSL Documents whose status is either **Draft OR Published**.

An exception to this rule exists for the search term **HealthCare Domains** where multiple values may be selected from the list and used in either a **OR** or **AND** expression for the query. Again, using the previous example, all "published or draft standards relating to messaging and/or health informatics" may be found by selecting both **Messaging** and **Health Informatics** from the list of **HealthCare Domain** values, and then selecting either **AND** or **OR** beneath the list, to use these values accordingly in the query.

Method 2 - Name or Keyword Search: a "search-string" (text) may be used to search for items whose **Name** and/or **Keywords** match the search text, either exactly or partially. The user would select either the **Document Name** or **Document Keywords** radio-button, provide a search-string to use for finding HCSL objects whose name (title) or keywords matched the search-string, and then submit the query by selecting the **Search (method 2)** submit-button.

Method 3 - Search by Relationship: this method allows searching the HCSL using a specific type of an **Relationship** to find items having that Relationship between them. This method is described in FAQ #14.

11. How can I add new information into the HCSL?

Users who have registered with HCSL, and who are members of an HCSL Group, or its Subgroups, may add, update, or delete information within that Group or its Subgroups. A Group or Subgroup member may only update or delete Group or Subgroup content that was submitted by them, or Group or Subgroup content for which update or delete permissions were granted by the owner of that content.

12. How can I update or delete information in the HCSL?

Existing content which has been added, or is "owned" by a member of a Group or Subgroup, may also be updated or deleted by that user (i.e. content owner). To update or delete content, the content owner would first need to login to the Group or Subgroup containing the content, search for and retrieve that content, and then click on the **Update** or **Delete** buttons shown on the page displaying the content. If **Update** was selected, an "update" form will display allowing the owner to modify the content, and submit the changes. If **Delete** was selected, the content will be deleted from the HCSL database.

13. What are 'Relationships' and how are they used?

The HCSL enables Relationships to be defined among registered content to describe a logical relationship that exists between the Objects. These Relationships may also be used in searching for content having specific Relationships between them. Each HCSL object may have a Relationship with

other HCSL objects, thus forming a Relationship between an "Object-pair," as follows:

- **Document-to-Document**
- **Document-to-Organization (or Organization-to-Document)**
- **Document-to-Portfolio (or Portfolio-to-Document)**
- **Organization-to-Organization**
- **Organization-to-Portfolio (or Portfolio to Organization)**
- **Portfolio-to-Portfolio**

Each of the above HCSL Object-pairs may be associated with each other through a named Relationship-type that describes a logical relationship that may exist between these Objects. The HCSL provides a drop-down list of Relationships that a user may select from to describe a type of relationship between two HCSL Objects.

For example, the named-Relationship **develops** can be used to associate an organization with the documents or standards that it develops, e.g. the organization HL7 **develops** HL7 Messaging, CDA, CCOW, etc., standards. Thus, an HCSL Organization object may have a relationship with one or more Document objects that it either **develops, uses, or manages**, where each of these terms describe the type of relationship between an Organization and a Document object. Similarly, the Relationship **includes** may be use between a Portfolio object and one or more Document objects to indicate Documents that are members of that Portfolio. Similarly, the Relationships **develops, manages, or uses**, may be used between an Organization object and a Portfolio object to describe the type of relationship between that Organization and its Portfolio. Of course, the user should select a type of Relationship that is meaningful for the two Objects since HCSL can not determine whether a Relationship is logical or not.

14. How can Relationships between HCSL objects be used for searching?

The HCSL currently supports searching based on Relationships that may exist between any two HCSL objects. The procedure involves a user selecting one of the various kinds of HCSL Object Relationship pairs (described above) and one of the named Relationship-types (also described above), that are to be used in searching for a given named type of Relationship between the chosen HCSL Object-pairs. For example, to find all possible Relationships that might exist between an **Organization** and related **Documents**, a user would use select **Relationship** from the **Search Content** menu selection, and then select a **Document** and an **Organization** to use as the HCSL Object-pair (from a drop-down list), and **All** as the value for the named Relationship-type (from a drop-down list). This search would return all Relationships between the Document and the Organization selected, if they exist. Alternatively, in the above example, the user could select **develops** for the named type of Relationship to find all Documents that were developed by that Organization.

In general, the following describes the steps in performing an Relationship-based search:

- *Select **Relationships**, under the **Search Content** Menu, to bring up the Relationships search page. The Relationships search page has three sections that determine which HCSL Object-pairs will be used in the search, e.g. **Organization-to-Document, Organization-to-Organization, Portfolio-to-Document**.*
- *Select the section (i.e. Organization, Document, or Portfolio) to be used as one member of the HCSL Object-pair for the Relationship search;*
- *From the chosen section, use the drop-down lists to a) select the other member of the HCSL Object-pair to be used for the Relationship search, and b) select a named Relationship-type (e.g. **develops, has, has liaison with, includes, etc**) to use as a Relationship between the chosen HCSL Object-pair.*
- *Select the **Search** button to begin the search.*

If the Relationship exists between the selected HCSL Object-Pair, a list of the names of the associated HCSL objects will be displayed as a result of the search. Otherwise, the results will be empty.

15. How are Relationships made between HCSL objects?

Relationships may be made between content-objects by owners of the content. Only registered users who are members of a Group or Subgroup may add and manage content, and make relationships between two content-objects (see FAQs #11, 12, & 19). A user may make a Relationship by first logging-in to HCSL and using the following procedure:

- *select **Relationship** under the **Add Content** Menu, then*
- *select the type of Relationship to be made from the drop-down list, e.g. Document-to-Document, Document-to-Organization, Organization-to-Portfolio, etc., and then*
- *select the **Submit** button.*
- *On the next web form, select, from the displayed drop-down lists, two specific objects and the Relationship to be made between these objects, and then*
- *select **Submit** to create the Relationship.*

For example, to make an Relationship between an Organization and a Document it publishes (say, HL7 and a standard it published), the user would:

- *select the Relationship type, "Document-to-Organization" and then*
- *select "HL7" from the Organization drop-down list,*
- *select "publishes" as the named-type of Relationship from the Relationship/Direction drop-down list, and*

- select "HL7 Messaging" (or another HL7 document) from the Document drop-down-list, while also selecting the direction of the Relationship between the objects by selecting the appropriate "directional-arrow " in the **Relationship/Direction** drop-down list (note that it is the user's responsibility to specify a meaningful type of Relationship and its direction between objects; the Landscape cannot distinguish between a logically valid and invalid relationship). Then,
- select **Submit**.

**** Note, the user will be notified if the Relationship was or was not made successfully. If a Relationship already exists between any two HCSL objects, attempting to make another Relationship will result in an error, since *only one defined Relationship at a time can exist between any two HCSL objects.***

16. How can Relationships for an object be viewed?

When the contents of a Document, Organization, or Portfolio object is retrieved and displayed, the **Browse Relationship(s)** link can be selected to view any possible Relationships. If these exist, they will be displayed on a subsequent web page. When Relationships are shown for an object, the user may easily access the other objects with which the current object is associated with by clicking on the link for those objects. In this way, a user may quickly see and traverse object Relationships.

17. Can the Relationships for an object be changed or deleted?

Yes, by users who "own" the content and relationship (typically a submitter of the content). When Relationships for an object are viewed, as described above, the owner of the content and relationship may select the **Delete or Update** buttons to delete or update a relationship, respectively. The **Update** function allows the name of the Relationship and its direction between objects to be changed; it does not allow changing either of the Objects that are currently associated by the Relationship, since this would create a new type of Relationship between one the existing two Objects and another Object. If a new Relationship is required between either of the existing Objects and another Object, a new Relationship should be made, as described previously in FAQ #15.

18. When viewing a Document or Organization object, I notice that its 'HealthCare Domains' are displayed as hot-links. What is the significance of these hot-links?

When an instance of a Document or an Organization object is added or later updated in the Landscape, it can be categorized or classified by one or more healthcare domains that may relate to it. These healthcare domains serve as indexes in the HCSL, and display as "hot-links" when a Document or Organization is retrieved and viewed. By clicking on a particular healthcare domain link, a user can quickly see a list of all other Documents or Organizations that are also categorized or classified by that same healthcare domain. For example, the Document, **HL7 Messaging** is associated with multiple healthcare

domains, including **Health Informatics**, and **Messaging**, both of which appear as hot-links when viewing the **HL7 Document**. By clicking on one of these links, a list of all other Documents in the Landscape, which are associated with **Health Informatics** or **Messaging** will be displayed. Any Document in the displayed list can then be selected to view the contents of that particular Document. The same can also be done with Organizations objects by selecting the displayed healthcare domain links used to classify an organization.

In general, various data fields in Document and Organization objects are used as indexes to allow these fields and values to be used in searching for specific content in the HCSL. For the **Document object**, the indexed fields are **Document Type**, **Document Status**, and **HealthCare Domain**. For the **Organization object**, the indexed fields are **Organization Type** and **HealthCare Domain**. Each indexed field has a list of enumerated values defined, from which the user may select one or more values to use in classifying the Document or Organization during creation or updating of the object. When a Document or Organization is viewed, the indexed field and selected values are displayed as hot-links, which may be clicked to quickly find all other Documents or Organizations having the same value assigned for that field.

19. What are HCSL Groups and Sub-Groups?

The Group/Sub-Group capability enables an organizational structure to be formed in the Landscape, which reflects an organization's structure. For example, a standards' development organization (SDO) typically has a hierarchical structure of committees, sub-committees, task forces, working groups, sub-working groups, etc., with associated members and documents (i.e. content) that are managed by each organizational component. Within this structure, some content may be shared with all members of an organization, while other content may only be shared by members of a sub-group until it is finalized and can be shared with others. The Group and Sub-Group capability provides the means for establishing and managing such an organizational structure of members and information (content) within HCSL.

Within HCSL, a named Group may be defined and assigned members and a Group Administrator (GA). Registered users of the HCSL may request to join HCSL Groups. The GA, assigned by the HCSL Administrator, may add or remove registered users from the Group, establish Sub-Groups (SGs), and designate Sub-Group Administrators (SGAs) from among members of the Group. Similarly, an SGA can add or remove members from a SG, establish subordinate sub-groups, and designate SGAs for those SGs. This process may be continued to establish a hierarchical structure of sub-groups within sub-groups (i.e. Sub-Sub-Groups), and to assign administrators and members to each of these sub-groups (See FAQ # 21 & 22).

20. What is the purpose of having HCSL Groups and Sub-Groups?

HCSL Groups and Sub-Groups enable organizations (or individuals) to establish

an organizational structure within HCSL for managing and controlling user membership and content of that Group and any Sub-Group(s). The Group or Subgroup Administrator manages the membership of their Group or Subgroup. Each member of a Group and Sub-Group may submit content, and decide who may access, view, add, delete, and update their content. Typically, most content will be public and viewable by all. However, there may be circumstances where a Group or Sub-Group member wishes to keep their content private, or only allow viewing by members of the Group or Sub-Group. Later, the Group or Sub-Group member may make their content public and allow viewing by all HCSL users.

21. How do I establish an HCSL Group or Sub-Group?

To Establish a Group

- *A registered user may establish a new Group by completing and submitting the HCSL form for creating a new Group. This is done by first logging in as a registered user and selecting **Create a Group** under the **Member Area** menu selection, and then completing and submitting the displayed form. Information requested on the form includes, Group Name, Description, and Objectives (purpose). Upon submission, this information is emailed to the HCSL Administrator, who will notify the requester by email when the Group has been established. The requesting user will also be made Administrator of the new Group.*

To Establish a Subgroup

- *A Group (or Subgroup) Administrator may establish one or more Subgroups within their Group (or Subgroup), and assign a Subgroup Administrator from among the members of their Group (or Subgroup). In turn, the Subgroup Administrator may establish one or more subordinate Subgroups under their Subgroup, assign Administrators to these Subgroups from among the members of their Subgroup, and so on. Group and Subgroup Administrators receive user requests to join, or be removed, from their Groups/Subgroups, and manage overall Group/Subgroup membership.*

22. How can I join or be removed from an HCSL Group or Sub-Group?

A registered user may join one or more Groups, and a Group member may join one or more Subgroups within a Group. A registered user may request to join, or leave, a Group (or Sub-Group) as described below:

To join a Group:

- *First register with HCSL and designate a Username and Password (the HCSL Administrator will confirm the registration by email).*
- *When confirmed, login to HCSL with your Username and Password.*

- Next, select the **Join another Group** selection under the **Member Area** menu item.
- Select a Group to join, from the list of displayed HCSL Groups, and **Submit** the request (the request will be sent by email to the Group Administrator, who accepts or refuses the request, and notifies the user by email).
- When accepted, login to HCSL, and the Group, for adding and managing content.

Once a user is a member of a Group, they can request to join any of its Subgroups, similar to the steps for joining a Group.

To join a Subgroup:

- First join a Group, as described above.
- Login to HCSL and your Group.
- Select the **Join another Group** selection under the **Member Area** menu item.
- Select a Subgroup to join, from the list of displayed Subgroups, and **Submit** the request (the request will be sent by email to the Subgroup Administrator, who accepts or refuses the request, and notifies the user by email).
- When accepted, login to HCSL, and the Subgroup, for adding and managing content.

To leave a Group or Subgroup:

- Login to the Group or Subgroup.
- Select the **My Group** selection under the **Member Area** menu.
- Select the link "**here**" in: Click **here** if you want to be removed from this group.
- On the next displayed page, click the **Remove** button to complete the request. An email will be sent to the Group/Subgroup Administrator indicating that the user has removed him/herself from the Group/Subgroup.
- When removed, a user can no longer login to that Group or Subgroup, or add or manage content in that Group or Subgroup. Any remaining user content will remain with the Group or Subgroup and be assigned to the Group or Subgroup Administrator.

***** Note:**

- **When a member is removed from a Subgroup they still remain a member of the Parent Group until they request to be removed from the Parent group.**
- **Conversely, a member cannot be removed from a Parent Group until they are first removed from any Subgroups, under that Parent, to which they**

belong.

- An Administrator cannot remove himself or herself from the Group or Subgroup that they administer. To be removed or replaced as the Group/Subgroup Administrator, they must contact the Administrator of the Parent Group or Subgroup to request removal or replacement. Only the Administrator of the parent Group or Subgroup can assign, replace, or remove the Administrator of a "child" Subgroup. Similarly, only the HCSL Administrator can assign, replace, or remove an Administrator of a top-level Group.

23. What happens to my content when I am removed from an HCSL Group or Sub-Group, or as a Registered User of the HCSL?

Content submitted by a Subgroup or Group member is "owned" and managed by that member until they either:

- 1. Delete the content*
- 2. Transfer content "ownership" to another member of the Subgroup or Group to which they belong*
- 3. Are removed from the Subgroup or Group*
- 4. Are removed as a Registered User of the HCSL*

In the 1st case above, deleted content is completely removed from the HCSL and is no longer available.

In the 2nd case above, "ownership" of the content is removed from the original owner and transferred to another Subgroup or Group member, and remains associated with the Subgroup or Group.

In the 3rd case above, any remaining content that has not been deleted or transferred to another Subgroup or Group member, remains part of the Subgroup or Group, and is automatically transferred to the "ownership" of the Subgroup or Group Administrator. The Administrator may, if they choose, transfer "ownership" of any content they "own" to another Subgroup or Group member.

In the 4th case above, any remaining content that was not deleted or transferred by the owner to another Subgroup or Group member, is automatically transferred to the "ownership" of the Subgroup or Group Administrator, or if the Subgroup or Group doesn't exist, it is automatically transferred to the "ownership" of the HCSL Administrator (see FAQ #24). In either case, the content remains available to users of the HCSL.

24. What happens to the content when a Subgroup or Group is removed?

The disposition of content for each of these situations follows:

When a Subgroup is removed:

- Subgroup content now becomes associated with the parent Group or Subgroup.
- Subgroup content remains under the "ownership" of the content owner, if the content owner is still a member of the parent Group. Otherwise, ownership of the content is automatically transferred to the Administrator of the parent Subgroup or Group.

When a Group is removed:

- Any remaining Group content, which has not been deleted, remains in the HCSL database under the "ownership" of the content owner, as long as they remain as a registered user of the HCSL. If a registered user (and their Group) is removed from the HCSL, their content is automatically transferred under the "ownership" of the HCSL Administrator and remains available in the HCSL (see FAQ #23).

25. What type of access controls does the HCSL provide?

The HCSL supports;

- Registered user login/logout using unique user names and passwords.
- Administrator controls over Group/Subgroup membership and default content permissions.
- Group/Subgroup member controls over who may view, modify, or delete their content (i.e. content permissions).
- Administrator controls to establish Subgroups, under their parent Group or Subgroup, and to assign Subgroup Administrators from among the membership of the parent Group/Subgroup.

Note that a registered user may change their password by selecting the **My Settings** option under the **Member Area** menu selection, and by then changing their password in the area indicated on the displayed page.

26. What is the current HCSL information model and how is it represented?

Currently, the HCSL supports three types of information objects:

- **Document object** (e.g. standard, report, regulation, guidelines, etc)
- **Organization object** (e.g. standard development organizations, agency, company, user group, etc)
- **Portfolio object** (i.e. a collection of Documents, typically a standards 'profile'; e.g. IHE, CHI, C-f-H, etc., standards profile. See FAQ #9)

Each of these types of objects contains information (content) about a particular Document, Organization, or Portfolio being described.

In addition, the HCSL enables relationships, called **Relationships**, to be specified among these objects. A Relationship defines a named type-of

relationship to be defined among HCSL objects that provides further information about a relationship that may exist between these objects, e.g. an "Organization **develops or uses** a Document" (e.g. standard; see FAQ #13)

These three types of information objects (**Document, Organization, Portfolio**), and their **Relationships**, comprise the current **HCSL information model**.

Each type of object is represented by an XML Schema in the HCSL. Each instance of an object in the HCSL conforms to one of these Schemas.

27. Can the HCSL information model be extended or modified?

Yes, but this will require software additions or modifications to support new or modified object types and their associated information. As more members of the healthcare community use the HCSL, we anticipate that suggestions will be made to add or modify the HCSL information model to include other types of information. NIST envisions that this will lead to a recommended "core" set of information that the HCSL should contain, and to a new HCSL information model that will contain this information. Hence, the HCSL information model will evolve to support a "common" set of healthcare standards' information that is needed by the broader community.

28. What software and hardware are needed to access the HCSL?

A computer able to connect to the Internet, with a web-browser that supports HTML/HTTP, Java, JScript, and XML/XSLT.

29. How is the current HCSL implemented?

The HCSL is implemented as a three-tiered Client-Server application on an MS Windows platform. The Server (Apache-Tomcat) provides Web pages to the Web Browser and an interface to the HCSL repository to store and retrieve health care standards information. An Oracle 9i RDBMS is currently used to manage the content repository. Application logic on the Server is written in Java and interfaces to the Oracle DBMS and Web Browser through XML/XSLT messages and Java Servlets. HCSL is also being implemented on a Linux platform, with interfaces to an Oracle, MySQL, and Postgres relational databases, to enable portability and use with other database systems in the future.

30. How can I submit comments or suggest changes or enhancements to the HCSL?

Comments, problem reports, or suggestions for changes or enhancements to the HCSL can be submitted by sending an email to the [HCSL Administrator](#). This can be done by either selecting a "**Mailto:**" link to the "HCSL Administrator" on those pages containing this type link, or by selecting the **Contact Us** option under the **User Support** menu selection, and then completing and submitting the **Contact** form. Note that the form provides a drop-down menu of message topics from which to select.

31. Who should I contact for further information about the HCSL?

For further information on the HCSL, contact:

- Tom Rhodes, Project Leader, (301) 975-3295, trhodes@nist.gov, or
- Lisa Carnahan, Manager, (301) 975-3362, lcarnahan@nist.gov.

15 Appendix D - User Roles and Privileges

Each type of HCSL user can be thought of as having a “role” in the Landscape with associated privileges and responsibilities, which that role may perform with content, users, or groups. These roles and privileges are described below for each type of user:

15.1 System Administrator (SA)

The SA (i.e., Landscape Administrator or “root” administrator) is responsible for overall management, operation, maintenance, and use of Landscape system to ensure the Landscape performs satisfactorily. This includes management of the hardware, software, data, users, groups, and group administrators. The System Administrator may:

1. Add or remove Registered Users (RU).
2. Notify a Registered User when they have been added or removed from the Landscape.
3. Add or delete Groups (G) and Subgroups (SG).
4. Assign, reassign, or delete a Registered User as the Group Administrator (GA) for a Group.
5. Notify a Registered User when they have been added or deleted as a Group Administrator of a Group.
6. Notify a Group Administrator when their Group has been added, modified, or deleted.
7. Assign, modify, and delete Group Administrator privileges (i.e. permissions) for managing a Group, including:
 - a. Add and delete Registered Users as Group Members (GM).
 - b. Add, re-name, or delete, Subgroups (SG) within that Group.
 - c. Add, re-assign, or delete, Subgroup Administrators (SGA) for Subgroups.
 - d. Notify a Group Administrator when they have had privileges modified.
8. Add, update, delete, manage, and transfer ownership of Landscape content.
9. Set and change default content access control permissions.

15.2 Anonymous User (AU)

1. Is a non-registered user of the Landscape.
2. May browse and view unrestricted or public content.
3. Cannot add, modify, or delete content in the Landscape.
4. May register as a Registered User in the Landscape, with a username and password for identification and login purposes, thus becoming a Guest User and member of the Guest Group.

15.3 Registered User (RU)

1. Is automatically a member of the Guest Group, and may be a member of zero or more other Groups in the Landscape.
2. May use their username and password to log in to the Landscape Guest Group, or any other Group or Subgroup of which they are members.
3. May request to join one or more Groups (G) as a member.
4. Is assigned to a Group by a Group Administrator and becomes a Group Member (GM) with associated privileges.
5. May request the System Administrator to remove them as a Registered User of the Landscape.

15.4 Guest User (GU)

1. Is a Registered User.
2. Is only a member of the Guest Group.
3. Has a user name and password to login to the Guest Group.
4. May request to join other Groups or create new Groups, where they will be assigned as the Group Administrator.
5. May browse and view unrestricted or public content in the Landscape.
6. Cannot add, modify, or delete content in the Guest Group (or Landscape).
7. May request the System Administrator to remove them as a Registered User of the Guest Group (i.e. Landscape).

15.5 Group Member (GM)

1. Is a Registered User of the Landscape.
2. Is a member of one or more Groups, and of the Guest Group, by default.
3. May remove themselves from a Group.
4. May login to their Group with a username and a password.
5. May change their username and/or password.
6. Is a member of zero or more Subgroups within a Group.
7. May request to be added as a member of a Subgroup within the Group.
8. May add content to the Group, and add content relationships.
9. May transfer ownership of their content to another Group Member.
10. May receive ownership of content transferred by another Group Member.
11. May modify and delete content and relationships that they own in the Group (i.e. content they “own”).
12. May change default content permissions to allow or restrict viewing of content they submitted or own for:
 - a. Other Group Members
 - b. Members of the parent Group.
 - c. Other Landscape users.

13. May change the default Group content permissions on content they own to allow or restrict other Group members to update or delete that content.
14. May add, modify or delete other Group content and/or add content relationships, as permitted by the owner of the content.
15. May allow or restrict other Group and Subgroup Members, to add relationships with content they own.
16. May be assigned by the Group Administrator to be a Subgroup Administrator (SGA) for a Subgroup (SG) within the parent Group.
17. May be assigned by the HCSL System Administrator to be the Group Administrator.

15.6 Group Administrator (GA)

1. Is assigned by the HCSL System Administrator, from either the Registered User who created the Group, or from among members of the Group.
2. A Group Administrator is a member of the Group.
3. A Group Administrator reviews and approves, or refuses, requests by Registered Users to become members of the Group.
4. A Group Administrator adds, or may remove, Registered Users as members of the Group.
5. A Group Administrator notifies Registered Users when they have been assigned or removed as a Group Members.
6. A Group Administrator sets the default permissions for reading or viewing Group content for Group members, parent Groups, and other Landscape users.
7. A Group Administrator notifies Group Members when the default permissions for Group content have been modified.
8. A Group Administrator adds or removes Subgroups within a parent Group.
9. A Group Administrator assigns, re-assigns, or removes a Group Member as a Subgroup Administrator (SGA) for a Subgroup within the Group.
10. A Group Administrator notifies a Group Member when they have been assigned or removed as a Subgroup Administrator.
11. A Group Administrator notifies a Subgroup Administrator when their administrative privileges or permissions have been modified.
12. Optionally, a Group Administrator may act as a Subgroup Administrator.
13. A Group Administrator may request the HCSL System Administrator to remove or replace them as the Administrator of a Group.

15.7 Subgroup Member (SGM)

Subgroup Members have the same responsibilities and privileges within their Subgroup, as Group Members have within their Groups.

1. A Subgroup Member is a member of a parent Group or Subgroup.
2. A Subgroup Member is a member of one or more Subgroups within a parent Group or Subgroup.

3. A Subgroup Member may remove themselves from a Subgroup.
4. A Subgroup Member may login to their Subgroup with a username and a password.
5. A Subgroup Member may change their username and/or password.
6. A Subgroup Member may request to be added as a member of a lower-level Subgroup within a parent Subgroup.
7. A Subgroup Member may add content within a Subgroup, and add content relationships.
8. A Subgroup Member may transfer ownership of their content to another Subgroup Member.
9. A Subgroup Member may modify and delete content and relationships that they have submitted in a Subgroup (i.e. content they “own”).
10. A Subgroup Member may change default content permissions to allow or restrict viewing of content they submitted or own for:
 - a. Other Subgroup Members
 - b. Members of the parent Group or Subgroup.
 - c. Other Landscape users.
11. A Subgroup Member may change the default Subgroup content permissions on content they own, to allow or restrict other Subgroup members to update or delete that content.
12. A Subgroup Member may add, modify or delete other Subgroup content and/or add content relationships, as permitted by the owner of the content.
13. A Subgroup Member may allow or restrict other Subgroup Members, and members of other Groups and Subgroups, to add relationships with content they own.
14. A Subgroup Member can be assigned to be the Subgroup Administrator by the Administrator of the parent Group or parent Subgroup.
15. A Subgroup Member can be assigned by the Subgroup Administrator to be an Administrator of a lower-level Subgroup (i.e. sub-subgroup), within the parent Subgroup.

15.8 Subgroup Administrator (SGA)

Subgroup Administrators have the same responsibilities and privileges within their Subgroups as Group Administrators have within their Groups.

1. A Subgroup Administrator is a member of a parent Group or Subgroup.
2. The Administrator of a parent Group or parent Subgroup assigns a member of a parent Group or Subgroup to be the Administrator of a Subgroup.
3. A Subgroup Administrator reviews and approves, or refuses, requests by parent Group, or parent Subgroup, members to become members of the Subgroup.
4. A Subgroup Administrator adds, or may remove, Subgroup Members.
5. A Subgroup Administrator notifies Subgroup members when they have been assigned to or removed from a Subgroup.

6. A Subgroup Administrator sets the default permissions for reading or viewing Subgroup content for members of their Subgroup, parent Group or Subgroup, and other Landscape users.
7. A Subgroup Administrator notifies Subgroup Members when the default permissions for Subgroup content have been modified.
8. A Subgroup Administrator adds or removes lower-level Subgroups within a parent Subgroup.
9. A Subgroup Administrator assigns, re-assigns, or removes Subgroup Members as Administrators of lower-level Subgroups within the parent Subgroup.
10. A Subgroup Administrator notifies Subgroup Members when they have been assigned or removed as Administrators of lower-level Subgroups within the parent Subgroup.
11. A Subgroup Administrator notifies Administrators of lower-level Subgroups, when their administrative privileges or permissions have been modified.
12. Optionally, a Subgroup Administrator may act as an Administrator of a lower-level Subgroup.
13. A Subgroup Administrator may request the Administrator of the parent Group, or Subgroup, to remove or replace them as the Administrator of a Subgroup.

16 Appendix E - HTMLArea Editor

The Landscape includes a WYSIWYG text editor, called the “HTMLArea” editor, which can be used to edit the content or appearance of text data for many HCSL data fields. Content may be entered directly, or copied and pasted, into the editor for editing or adding of HTML tags that enhance the display or presentation of the content.

The HTMLArea editor is accessed by clicking on a hot-link that appears near the top of the content data entry forms, as shown in Section 6 (See Figure 57, Figure 58, Figure 59), and in the content update forms (See Figure 61). Clicking this link opens the editor in a new window, shown in Figure 84, in which the user can do text editing.

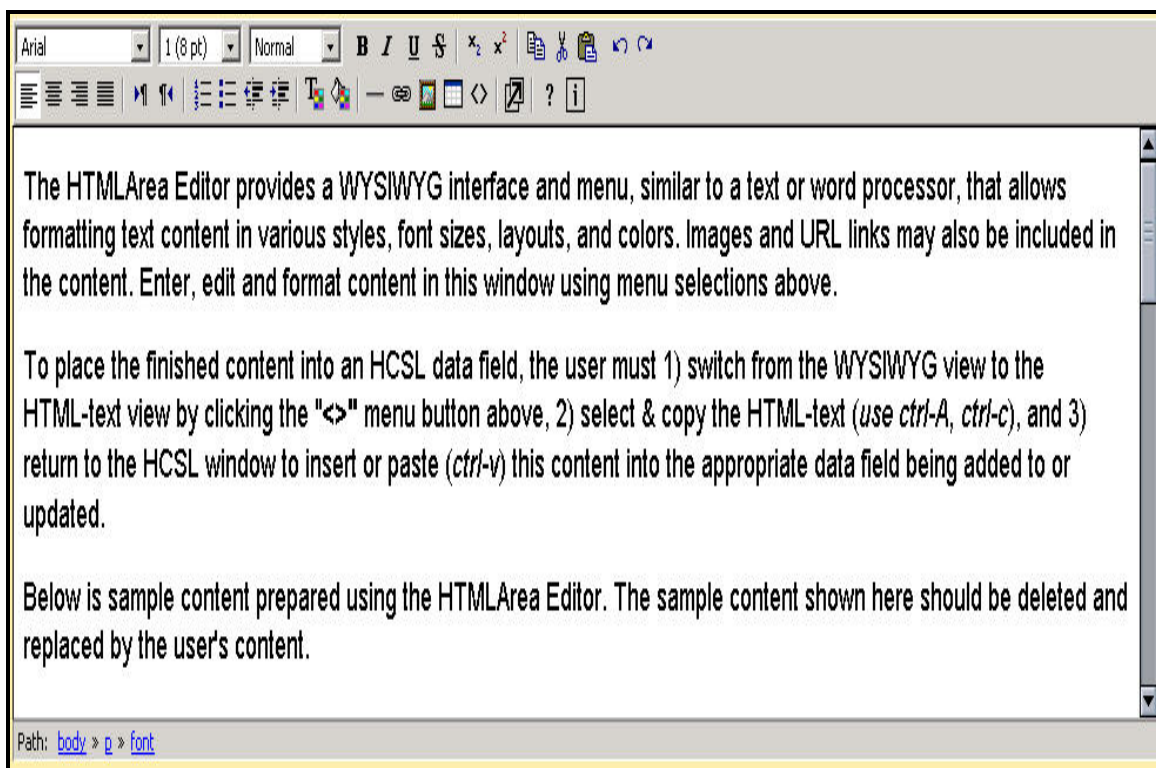

Figure 84 HTMLArea Editor initial window

The HTMLArea editor includes a toolbar with features to edit and format text, and a brief explanation for using the editor in the text area. An example of formatted text, including a graphic, is also illustrated in the text area, as shown in Figure 85 (WYSIWYG view).

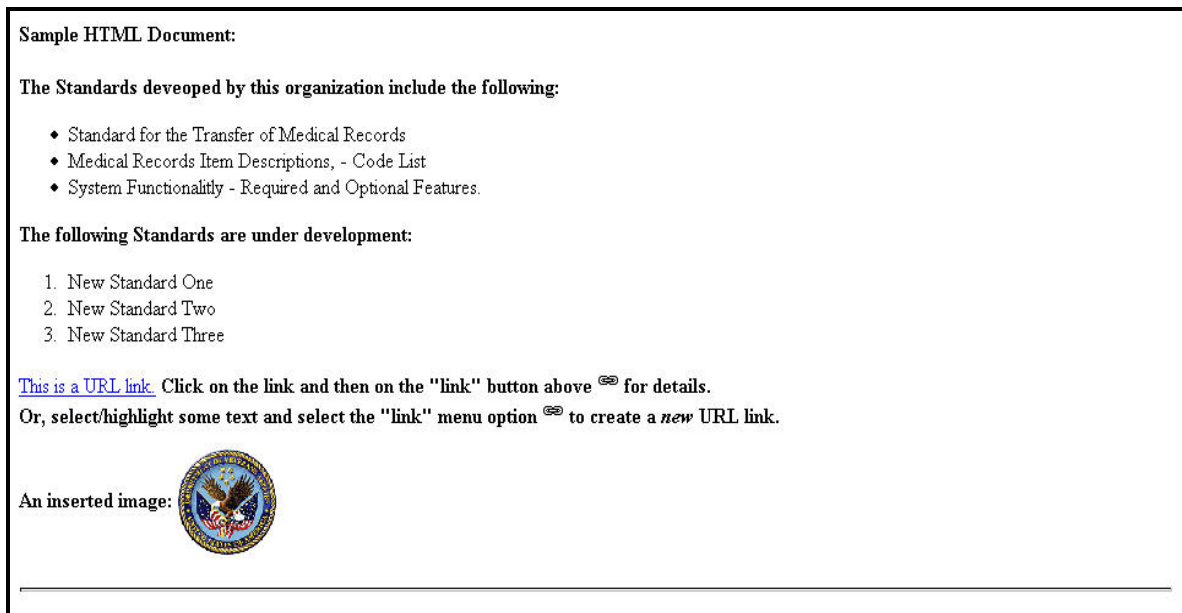

Figure 85 WYSIWYG View of Sample Content with HTML styling.

Text and graphic data may be entered into the editor, or existing content may be copied from an HCSL data field, pasted into the editor, edited, and then copied and pasted back into the HCSL data field. When editing is complete, a user toggles the editor from the WYSIWYG view to the text view by clicking the "<>" menu button, to select, copy (may ctrl-A & ctrl-C), and paste (may ctrl-V) the edited text and/or HTML content into the appropriate data field of the HCSL data-entry or update form. Figure 86 shows the sample content in the HTML Text view, which is used to select, copy, and paste the edited content into the appropriate HCSL input data field.

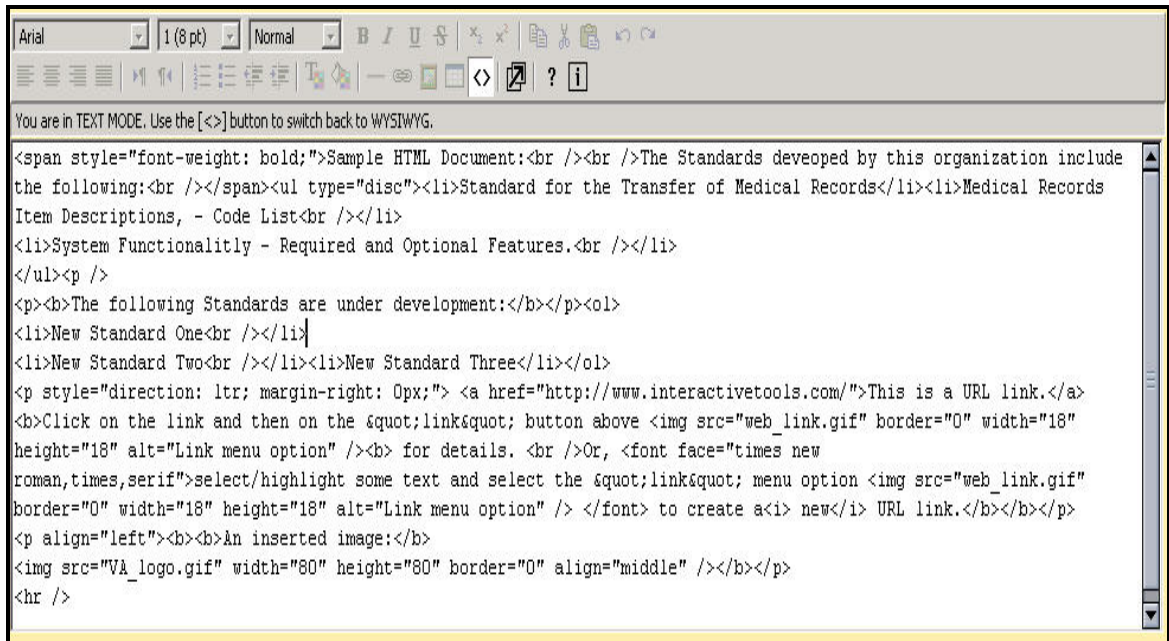
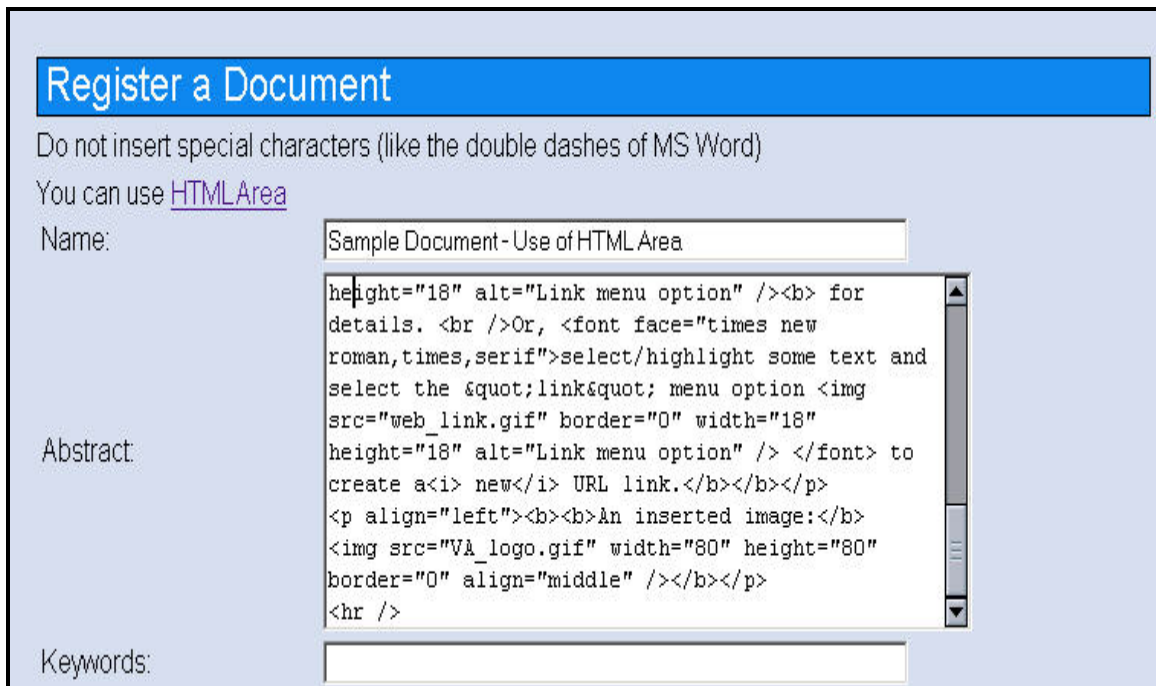

Figure 86 Text View of Sample Content with HTML Tags

In Figure 87 below, the sample content has been pasted into the “Abstract” data field of the data input form for a new Document record being entered into the Landscape.



The screenshot shows a web form titled "Register a Document" with a blue header. Below the header, there is a warning: "Do not insert special characters (like the double dashes of MS Word)" and a link: "You can use [HTMLArea](#)". The form has three main input fields: "Name:", "Abstract:", and "Keywords:". The "Name:" field contains the text "Sample Document - Use of HTML Area". The "Abstract:" field contains a large block of HTML code. The "Keywords:" field is empty. The HTML code in the Abstract field is as follows:

```
height="18" alt="Link menu option" /><b> for
details. <br />Or, <font face="times new
roman,times,serif">select/highlight some text and
select the &quot;link&quot; menu option  </font> to
create a<i> new</i> URL link.</b></b></p>
<p align="left"><b><b>\n inserted image:</b>
</b></p>
<hr />
```

Figure 87 Sample Edited Content Pasted into New Document Record (partial contents)

When a user views this document in the Landscape, it will appear as formatted in the WSIWYG view, shown previously in Figure 85.

17 Index

A

Access, 5, 8, 103, 104, 110, 112, 115, 116
Add content, 35, 119, 121
Administrative privileges, 120, 122
Administrator, 33, 34, 35, 36, 51, 76, 80, 100, 101, 102, 111, 112, 113, 114, 115, 116, 118, 120, 121, 122
Appendix, 34, 56, 58, 118, 123
Appendix A, 4, 54, 88
Appendix B - Glossary, 100
Appendix C, 83
Appendix C - FAQ, 80, 82, 83, 103
Appendix D, 34, 118
Appendix E, 56, 58, 123

B

Boolean Search, 106
Browse, 5, 6, 10, 19, 21, 24, 30, 31, 32, 35, 53, 100, 101, 103, 104, 105, 110, 118, 119

C

Consolidate Health Informatics, 105
Content, 1, 5, 6, 7, 9, 12, 14, 15, 16, 17, 20, 22, 23, 24, 26, 33, 34, 35, 47, 51, 56, 58, 80, 100, 101, 102, 103, 104, 105, 106, 107, 108, 109, 110, 111, 112, 113, 114, 115, 116, 118, 119, 120, 121, 122, 123

D

Default Content Permissions, 115
Delete, 5, 7, 35, 100, 103, 104, 107, 110, 112, 114, 115, 118, 119, 120, 121
Document, 7, 16, 17, 18, 26, 54, 60, 82, 83, 100, 110
Document keywords, 16, 107
Document schema, 70, 88

Document Status, 12, 13, 14, 15, 17, 100, 106, 107, 111
Document Type, 7, 12, 13, 14, 15, 17, 100, 106, 111

E

Enumerated Values, 12, 100, 106, 111

G

Group, 4, 7, 31, 34, 35, 36, 49, 50, 51, 52, 53, 54, 76, 77, 79, 80, 100, 101, 103, 104, 105, 107, 109, 111, 112, 113, 114, 115, 118, 119, 120, 121
Guests, 104

H

HCSL, 1, 2, 3, 4, 5, 6, 7, 12, 20, 26, 36, 37, 51, 86, 94, 100, 101, 102, 103, 104, 105, 106, 107, 108, 109, 110, 111, 112, 113, 114, 115, 116, 117, 123
Health Informatics, 1, 2, 3, 4, 13, 86, 104, 105, 107, 111
Healthcare Domain, 15, 16, 17, 22, 110
HealthCare Domain, 103, 110
Healthcare Stakeholders, 2, 86, 104
Hierarchical Structure, 7, 111
Hot-Links, 17, 103, 110, 111
HTML Area, 56, 58

I

Index, 126
Indexed Element, 12, 21, 106
Indexes, 12, 20, 106, 110, 111
Informatics Standards, 3, 86, 105

K

Keyword Search, 107
Keywords, iii, 6, 16, 22, 100, 101, 106, 107

L

Links, 2, 17, 24, 70, 83, 86, 100, 103, 104, 105, 110

M

Messaging, 4, 12, 13, 17, 18, 26, 105, 106, 107, 108, 110
Multiple values, 12, 13, 21, 22, 106, 107
Multiple Values, 12, 13, 21, 22, 106, 107
My Settings, 115

O

Object, 7, 26, 100, 101, 103, 105, 106, 107, 108, 109, 110, 111, 115, 116
Organization, 1, 7, 22, 23, 24, 26, 34, 56, 58, 60, 70, 88, 100, 101, 105, 108, 111

P

Padlock Icon, 48
Password, 5, 35, 101, 104, 105, 112, 115, 119, 121
Permissions, 76, 100
Portfolio, 4, 7, 24, 25, 26, 58, 62, 70, 88, 99, 101, 103, 105, 108, 109, 110, 115, 116
Portfolio schema, 70, 88
Privileges, 34, 35, 36, 118, 119, 120, 121
Problem Reports, 116

R

Register a Document, 54, 55
Registered User, 5, 7, 33, 34, 35, 100, 101, 103, 105, 109, 111, 112, 114, 115, 118, 119

Registration, 35, 36, 37, 105, 112
Role, 34, 118
Roles and Privileges, 34, 118

S

Sample Query, 22
Schema, 70, 88, 93, 94, 98, 99, 101, 116
Search, iii, 5, 6, 7, 9, 11, 12, 13, 15, 16, 17, 20, 22, 23, 24, 25, 26, 60, 100, 101, 103, 104, 105, 106, 107, 108, 109
Search-Term, 106
Server, 2, 4, 104, 116
Software, 2, 35, 103, 116, 118
Special characters, 56
Specifications, 1, 3, 105
Standards, 1, iii, 1, 2, 3, 4, 7, 12, 13, 26, 58, 83, 86, 100, 101, 103, 104, 105, 106, 107, 108, 111, 115, 116
Standards Development Organization, 1, 2, 7, 86, 105
Sub-Group, 7, 34, 36, 103, 111, 112, 114
Sub-Groups, 7, 36, 103, 111

T

Table of Contents, iv

U

Update, 5, 7, 56, 103, 107, 110, 112
User-Name, 104
Users, 1, 2, 5, 6, 7, 8, 34, 35, 83, 86, 100, 104, 105, 107, 110, 111, 112, 114, 118, 119, 125

W

Web Browser, 104, 116

The version of this Document is: HCSL_Users-Guide.PDF, December 2006.