

A11103 073222

NATL INST OF STANDARDS & TECH R.I.C.



A11103073222

Workshop on Eddy Cur/Eddy current nondes  
QC100 .U57 NO.589, 1981 C.1 NBS-PUB-C 19



DEPARTMENT OF COMMERCE  
NATIONAL BUREAU OF STANDARDS

# NBS SPECIAL PUBLICATION 589

U.S. DEPARTMENT OF COMMERCE / National Bureau of Standards

## Eddy Current Nondestructive Testing

QC  
100  
.U57  
NO. 589  
1981  
c. 2

# NATIONAL BUREAU OF STANDARDS

The National Bureau of Standards<sup>1</sup> was established by an act of Congress on March 3, 1901. The Bureau's overall goal is to strengthen and advance the Nation's science and technology and facilitate their effective application for public benefit. To this end, the Bureau conducts research and provides: (1) a basis for the Nation's physical measurement system, (2) scientific and technological services for industry and government, (3) a technical basis for equity in trade, and (4) technical services to promote public safety. The Bureau's technical work is performed by the National Measurement Laboratory, the National Engineering Laboratory, and the Institute for Computer Sciences and Technology.

**THE NATIONAL MEASUREMENT LABORATORY** provides the national system of physical and chemical and materials measurement; coordinates the system with measurement systems of other nations and furnishes essential services leading to accurate and uniform physical and chemical measurement throughout the Nation's scientific community, industry, and commerce; conducts materials research leading to improved methods of measurement, standards, and data on the properties of materials needed by industry, commerce, educational institutions, and Government; provides advisory and research services to other Government agencies; develops, produces, and distributes Standard Reference Materials; and provides calibration services. The Laboratory consists of the following centers:

Absolute Physical Quantities<sup>2</sup> — Radiation Research — Thermodynamics and Molecular Science — Analytical Chemistry — Materials Science.

**THE NATIONAL ENGINEERING LABORATORY** provides technology and technical services to the public and private sectors to address national needs and to solve national problems; conducts research in engineering and applied science in support of these efforts; builds and maintains competence in the necessary disciplines required to carry out this research and technical service; develops engineering data and measurement capabilities; provides engineering measurement traceability services; develops test methods and proposes engineering standards and code changes; develops and proposes new engineering practices; and develops and improves mechanisms to transfer results of its research to the ultimate user. The Laboratory consists of the following centers:

Applied Mathematics — Electronics and Electrical Engineering<sup>2</sup> — Mechanical Engineering and Process Technology<sup>2</sup> — Building Technology — Fire Research — Consumer Product Technology — Field Methods.

**THE INSTITUTE FOR COMPUTER SCIENCES AND TECHNOLOGY** conducts research and provides scientific and technical services to aid Federal agencies in the selection, acquisition, application, and use of computer technology to improve effectiveness and economy in Government operations in accordance with Public Law 89-306 (40 U.S.C. 759), relevant Executive Orders, and other directives; carries out this mission by managing the Federal Information Processing Standards Program, developing Federal ADP standards guidelines, and managing Federal participation in ADP voluntary standardization activities; provides scientific and technological advisory services and assistance to Federal agencies; and provides the technical foundation for computer-related policies of the Federal Government. The Institute consists of the following centers:

Programming Science and Technology — Computer Systems Engineering.

<sup>1</sup>Headquarters and Laboratories at Gaithersburg, MD, unless otherwise noted; mailing address Washington, DC 20234.

<sup>2</sup>Some divisions within the center are located at Boulder, CO 80303.

FEB 27 1981

*not acc. - Circ*

*QC100*

*. U57*

*no. 589*

*1981*

*C. 2*

# Eddy Current Nondestructive Testing

Proceedings of the Workshop on  
Eddy Current Nondestructive Testing,  
held at the National Bureau of Standards,  
Gaithersburg, Maryland, on November 3-4, 1977

Edited by:

George M. Free

Center for Absolute Physical Quantities  
National Measurement Laboratory  
National Bureau of Standards  
Washington, DC 20234



*x Special publication*

---

U.S. DEPARTMENT OF COMMERCE, Philip M. Klutznick, Secretary

Jordan J. Baruch, Assistant Secretary for Productivity, Technology and Innovation

U.S. NATIONAL BUREAU OF STANDARDS, Ernest Ambler, Director

Issued January 1981

Library of Congress Catalog Card Number: 80-600172

National Bureau of Standards Special Publication 589

Nat. Bur. Stand. (U.S.), Spec. Publ. 589, 153 pages (Jan. 1981)

CODEN: XNBSAV

U.S. GOVERNMENT PRINTING OFFICE

WASHINGTON: 1981

---

For sale by the Superintendent of Documents, U.S. Government Printing Office  
Washington, D.C. 20402 - Price \$5.50



## FOREWORD

Although testing with eddy currents is regarded as one of the major methods for nondestructive inspection, many people in the industry regard this technique as one that offers much greater potential than is presently realized. It is now used primarily for the sorting of alloys by conductivity measurements and for the inspection of relatively thin conducting material; thin-walled tubing constitutes a major inspection item for eddy current techniques.

In the Nondestructive Evaluation (NDE) Program at the National Bureau of Standards, we are working to improve the reliability of nondestructive measurements. The present effort in eddy current testing is directed primarily at conductivity measurements; a measurement service and standard reference materials are planned to help the industry improve this type of NDE measurements. Looking beyond that, however, we at NBS agree that new ideas and developments can lead to greater utilization of eddy current methods. One means to examine that potential was a Workshop on Eddy Current Nondestructive Testing; the Workshop was held at NBS on November 3 and 4, 1977, under the joint sponsorship of the NBS Electricity Division and the NDE Program.

These Proceedings are a record of that Workshop.

The purposes of the Workshop were to (1) review the current status of eddy current measurement methodology and applications, (2) define the directions for improved techniques and applications, and (3) assess the needs for work on standards and underlying science to address present and future problems. The attendees were drawn from industry, university, and government. We have thanked them all individually, but it is appropriate here also to express our appreciation to them again and particularly to the speakers.

I also wish to express my appreciation to the planners of the Workshop, Norman Belecki, George Free, and Barry Taylor of the NBS Electricity Division; George Birnbaum, of the NDE Program; and Robert Green of the Johns Hopkins University. I am confident that these Proceedings will serve their intended purposes and help the industry and NBS define fruitful areas for additional work to improve eddy current nondestructive testing.

Harold Berger  
Program Manager  
Nondestructive Evaluation  
February 1978



## PREFACE

The intent of these Proceedings is to provide a record of the NBS Workshop on Eddy Current Nondestructive Testing. With the exception of the first paper, an overview of eddy current testing by Dr. Robert McMaster, each paper presented was followed by a period of discussion. The Proceedings followed the same format. Unfortunately, the comments of participants could not be attributed in all cases, but where it is possible the authors of the many comments, questions, and ideas are noted. Some editing of the discussion periods was done, consequently the discussion periods are not "verbatim."

Due to the method of printing the proceedings, not all pictures and diagrams turned out to be of equal clarity. I apologize beforehand to those authors whose pictures or diagrams are not of the excellent quality which the participants viewed at the workshop.

George M. Free  
Editor



	PAGE
FOREWORD	iii
Harold Berger	
PREFACE	v
ABSTRACT	viii
THE HISTORY, PRESENT STATUS, AND FUTURE DEVELOPMENTS OF EDDY CURRENT TESTS	1
Robert C. McMaster	
EDDY CURRENT TESTING: PRESENT AND FUTURE APPLICATIONS IN THE FERROUS METAL INDUSTRY	33
Richard B. Moyer	
EDDY CURRENT STANDARDS IN NONFERROUS METALS	39
Carlton E. Burley	
EDDY CURRENT INSPECTION OF GAS TURBINE BLADES	45
Robert A. Betz	
EDDY CURRENT EXAMINATION IN THE NUCLEAR INDUSTRY	49
Allen E. Wehrmeister	
EDDY CURRENT INSPECTION SYSTEMS FOR STREAM GENERATOR TUBING IN NUCLEAR POWER PLANTS	57
Clyde J. Denton	
USE OF ROUND ROBIN TESTS TO DETERMINE EDDY CURRENT SYSTEM PERFORMANCE	63
E. R. Reinhart	
EDDY CURRENT TESTING IN GOVERNMENT	77
Patrick C. McEleney	
CURRENT STATUS AND FUTURE DIRECTIONS OF EDDY CURRENT INSTRUMENTATION	81
Tracy W. McFarlan	
MULTIFREQUENCY EDDY CURRENT INSPECTION TECHNIQUES	87
Hugo L. Libby	
PULSED EDDY CURRENT TECHNIQUES FOR NONDESTRUCTIVE EVALUATION	107
D. L. Waidelich	
THE INTRODUCTION OF SIGNAL PROCESSING TECHNIQUES TO EDDY CURRENT INSPECTION	113
E. E. Weismantel	
DEVELOPMENT OF NON-FERROUS CONDUCTIVITY STANDARDS AT BOEING	121
Arthur Jones	
NBS EDDY CURRENT STANDARDS PROGRAM	133
George Free	
ELECTROMAGNETIC THEORY AND ITS RELATIONSHIP TO STANDARDS	137
Arnold H. Kahn and Richard D. Spal	
DISCUSSION: NEW SCIENCE DIRECTIONS AND OPPORTUNITIES CONCLUDED FROM WORKSHOP SESSIONS	143
Leader: Robert E. Green	
DISCUSSION: NEW DIRECTIONS FOR STANDARDS CONCLUDED FROM WORKSHOP SESSIONS	149
Leader: Norman B. Belecki	
SPECIAL ACKNOWLEDGEMENTS	155
LIST OF WORKSHOP PARTICIPANTS	157



## ABSTRACT

The proceedings of the Eddy Current Nondestructive Testing Workshop held at NBS in November 1977 contain papers related to all areas of eddy current testing. A historical overview of the discipline from its inception until the present is given. Other papers discuss the use of eddy current testing in the primary metals industry (both ferrous and nonferrous metals), the use of eddy currents for the sorting of metals and for defect detection, the state-of-the-art in eddy current instrumentation, and the use of signal processing in the analysis of eddy current signals. The development and use of eddy current standards is discussed as well as several of the newer areas of eddy current development, i.e., multifrequency and pulsed eddy current techniques.

Key words: Conductivity; defect detection; eddy current test; multifrequency; nondestructive testing.

## THE HISTORY, PRESENT STATUS, AND FUTURE DEVELOPMENT OF EDDY CURRENT TESTS

Robert C. McMaster

Departments of Electrical Engineering and Welding Engineering  
The Ohio State University  
Columbus, OH

### 1. Historical Development of Eddy Current Theory and Test Methods

It is probable that no other form of nondestructive testing has a history of illustrious scientific creativity and practical development that compares with the past century and a half of development of the concepts and applications of electromagnetic induction and eddy current testing. James Clerk Maxwell, in his remarkable two-volume work A Treatise on Electricity and Magnetism, published in several editions from 1873 to 1891, summarized the first half century of this history [1]<sup>1</sup>. In addition, he conceived and published the comprehensive group of relations known as Maxwell's equations for the electromagnetic field, which mathematically represent almost the entire present knowledge of this subject. For the past hundred years, physicists and researchers in electricity and magnetism have occupied themselves with numerous applications of Maxwell's theory. However, during this past century, no one has conceived any significant new law to be added to Maxwell's principles (with the possible exception of Einstein's theory of relativity, which extends the theory of the electromagnetic field to a four-dimensional framework of three spatial dimensions and a fourth dimension of time). NOTE: In the following segments abstracted from Maxwell's treatise, the symbol .... indicates omissions. Parentheses are used to indicate explanatory words or comments inserted by the author of this paper. Superscript numbers following headings identify the specific articles of Maxwell's treatise used as sources.

### 2. Oersted's 1820 Discovery of the Magnetic Field of an Electric Current<sup>(475-478)</sup>

As described by Maxwell, "...Conjectures of various kinds had been made as to the relation between electricity and magnetism, but the laws of these phenomena, and the form of these relations, remained entirely unknown till Hans Christian Oersted, at a private lecture to a few advanced students at Copenhagen, observed that a wire connecting the ends of a voltaic battery affected a magnet in its vicinity. This discovery he published in a tract...dated July 21, 1820 [2]. ...Oersted discovered that the current itself was the cause of the action, and that the 'electric conflict acts in a revolving manner', that is, that a magnet placed near a wire transmitting an electric current tends to set itself perpendicular to the wire, and with the same end always pointing forwards as the magnet is moved around the wire... The space in which these forces act may therefore be considered as a magnetic field... In the case of an indefinitely long straight wire carrying an electric current...the lines of magnetic force are everywhere at right angles to planes drawn through the wire, and are therefore circles each in a plane perpendicular to the wire, which passes through the wire." (Had Oersted been provided with a much larger current, it is possible that even a piece of nonmagnetic conducting metal lying adjacent to the current-carrying loop would have reacted to sudden application of the current, by eddy current reaction. Had this accident occurred, it is possible that the discovery of the effects of eddy currents might possibly have occurred more than 150 years ago.)

<sup>1</sup>Figures in brackets indicate literature references at the end of this paper.

### 3. Ampere's 1820 Discovery of the Mutual Interaction of Two Currents (502-504)

Maxwell continues "...The action of one circuit upon another was originally investigated in a direct manner by Ampere almost immediately (in 1820) after the publication of Oersted's discovery....Ampere's fundamental experiments are all of them examples of...the null method of comparing forces.... In the null method, two forces, due to the same source, are made to act simultaneously on a body already in equilibrium...No effect is produced, which shows that these forces are themselves in equilibrium. This method is peculiarly valuable for comparing the effects of the electric current when it passes through circuits of different forms. By connecting all the conductors in one continuous series, we ensure that the strength of the current is the same at every point of its course.... Since the current begins everywhere throughout its course almost at the same instant, we may prove that the forces due to its action on a suspended body are in equilibrium by observing that the body is not at all affected by the starting or the stopping of the current.

"Ampere's balance consists of a light frame capable of revolving about a vertical axis, and carrying a wire which forms two (rectangular loop) circuits of equal area, in the same plane or in parallel planes, in which (loops) current flows in opposite directions. The object of this arrangement is to get rid of the effects of terrestrial magnetism on the conducting wire....By rigidly connecting two circuits of equal area in parallel planes, in which equal currents run in opposite directions, a combination is formed which is unaffected by terrestrial magnetism...(This balance) is therefore called an Astatic Combination (see fig. 1). It is acted upon, however, by forces arising from currents or magnets which are so near to it that they act differently on the two circuits. ....Ampere's theory of the mutual action of electric currents is founded on four experimental facts and one assumption."

Ampere's 1820 experiments provided several useful techniques employed in present-day eddy current test systems, including:

1. The methods of shielding lead-wire connections to test coils.

2. The use of comparison-coil arrangements to reduce or eliminate test signal components related to common properties of two test objects.

3. The use of differential-coil arrangements to compare local differences in properties of adjacent areas of a single test object.

4. The methods of coupling magnetizing-coil fields with test material surfaces.

5. The use of dual-coil systems to balance out external magnetic and electric field effects (including terrestrial magnetism).

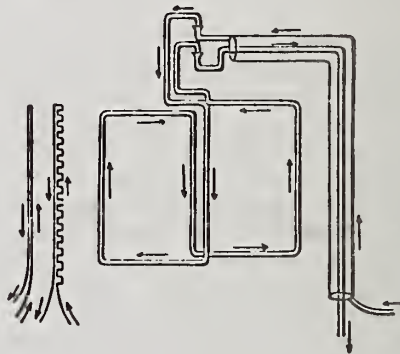

Figure 1. Maxwell's sketch illustrating Faraday's basic test arrangement with astatic balance coil arrangement [1].

(It would be difficult to estimate how many hundreds of 20th century patents are based upon these simple discoveries by Ampere a hundred years earlier. It would also be difficult to estimate the man-years of effort and dollar costs lost during recent developments of eddy current test systems by workers who were not aware of the full significance of Ampere's 1820 work.)

#### 3.1 Ampere's first experiment (Shielding of lead wires) (505)

In Maxwell's words, "Ampere's first experiment is on the effect of two equal currents close together (flowing) in opposite directions. A wire covered with insulation is doubled upon itself and placed near one of the circuits of the astatic balance (See fig. 1). When a current is made to pass through the (looped-back) wire and (the compensated loops of) the balance, the equilibrium of the balance remains undisturbed, showing that two equal currents close together in opposite directions neutralize each other.



If, instead of two wires side by side, a wire be insulated in the middle of a metal tube, and if the current pass through the wire and back by the tube, the action outside the tube is not only approximately but accurately null. This principle is of great importance in the construction of electric apparatus, as it affords the means of conveying the current to and from any galvanometer or other instrument in such a way that no electromagnetic effect is produced by the current on its passage to and from the instrument. In practice, it is generally sufficient to bind the wires together, care being taken that they are kept perfectly insulated from each other, but where they must pass near any sensitive part of the apparatus it is better to make one of the conductors a tube and the other a wire inside it." (These techniques, including also twisted lead pairs, are commonly used to connect instruments to sensing coils or semiconductor detectors used today to detect eddy current magnetic field test signals. At higher frequencies, shielding by concentric conductors (usually grounded at one end) aids in avoidance of interfering signals from ambient electromagnetic fields or moving ferromagnetic machine parts or test objects.)

### 3.2 Ampere's second experiment (Effect of crooked current paths)<sup>(506)</sup>

Maxwell reports: "In Ampere's second experiment one of the wires is bent and crooked with a number of small sinuosities, but so that in every part of its course it remains very near the straight wire. (See fig. 1) A current flowing through the crooked wire and back again through the straight wire, is found to be without influence upon the astatic balance. This proves that the effect of the current running through any crooked part of the wire is equivalent to the same current running in the straight line joining its extremities, provided the crooked line is in no part of its course far from the straight one. Hence any small element of a circuit is equivalent to two or more component elements, the relation between the component elements and the resultant element being the same as that between component and resultant displacements or velocities." (This basic principle has been generally ignored with respect to its significance in detection of small discontinuities that locally distort eddy current flow paths. A circular test coil, for example, produces a mirror-image

circular flow path of eddy currents in the adjacent test material. Small diversions and excursions of eddy currents from a truly circular path will have very small effects upon signal pickup coils coincident with the magnetizing coils. Local detectors of distortions of the eddy current magnetic field can have far greater sensitivity to small discontinuities than large-area pickup coils.)

### 3.3 Ampere's third and fourth experiments<sup>(507-509, 520-521)</sup>

Ampere's third experiment demonstrated that external currents or magnets had no tendency to move a straight current-carrying conductor in the direction of its length (see fig. 2). The fourth experiment showed that the force

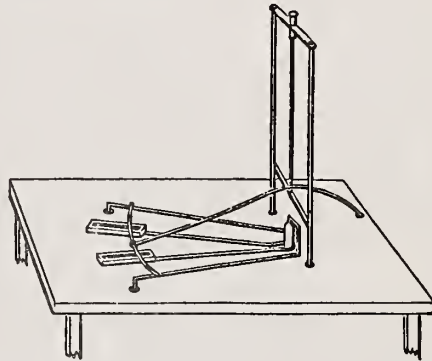

Figure 2. Maxwell's sketch illustrating Faraday's third experiment showing no force acting along the length of a current carrying conductor.

acting between two adjacent current-carrying loops varies as the square of the distance between the two loops. Analyses of these results indicates that the mutual potential  $M$  of two closed circuits carrying unit current expresses the work done by electromagnetic forces on either conducting circuit when it moves parallel to itself from an infinite distance to its actual position. Any alteration of its position, by which  $M$  is increased, will be assisted by the magnetic forces. Even when the motion of the circuit is not parallel to itself, the forces acting on it are still determined by the variation of  $M$ , the potential of one circuit on the other. The force between the circuits is  $dM/dx$ , and thus  $M$ , is related to the energy of the electromagnetic field of the current-carrying circuits.

#### 4. Faraday's 1831 Discovery of the Law of Electromagnetic Induction<sup>(528-541)</sup>

Maxwell notes that: "The discovery by Oersted of the magnetic action of an electric current led by a direct process of reasoning to that of magnetization by electric currents, and of the mechanical action between currents. It was not, however, till 1831 that Faraday, who had been for some time endeavouring to produce electric currents by magnetic or electric action, discovered the conditions of magneto-electric induction. The method which Faraday employed in his researches consisted of a constant appeal to experiment as a means of testing the truth of his ideas, and a constant cultivation of ideas under the direct influence of experiment. Faraday...shows us his unsuccessful as well as his successful experiments, and his crude ideas as well as his developed ones. The reader, however inferior to him in inductive power, feels sympathy even more than admiration, and is tempted to believe that, if he had the opportunity, he too would be a discoverer. Every student should therefore read Ampere's research as a splendid example of scientific style in the statement of a discovery, but he should also study Faraday for the cultivation of a scientific spirit, by means of the action and reaction which will take place between the newly-discovered facts as introduced to him by Faraday and the nascent ideas of his own mind.

"The method of Faraday seems to be intimately related to the method of partial differential equations and integrations throughout all space...He never considers bodies as existing with nothing between them but their distance, and acting upon one another according to some function of that distance. He conceives all space as a field of force, the lines of force being in general curved, and those due to any body extending from it on all sides, their directions being modified by the presence of other bodies. He even speaks of the lines of force belonging to a body as in some sense part of itself, so that in its action on distant bodies it cannot be said to act where it is not. This, however, is not a dominant idea with Faraday. I think he would rather have said that the field of space is full of lines of force, whose arrangement depends on that of the bodies in the field, and that the mechanical and electrical action on each body is determined by the lines which abut on it."

#### 4.1 Faraday's law for induction by variation of primary current<sup>(530)</sup>

Maxwell advises the reader to read Faraday's "Experimental Researches, Series i and ii," and then summarizes four forms of Faraday's law of induction. His description of the first form of Faraday's law follows:

"Let there be two conducting circuits, the Primary and the Secondary circuit. The primary circuit is connected with a voltaic battery by which the primary current may be produced, maintained, stopped, or reversed. The secondary circuit includes a galvanometer to indicate any currents which may be formed in it. This galvanometer is placed at such a distance from all parts of the primary circuit that the primary current has no sensible direct influence upon its indications.

"Let part of the primary circuit consist of a straight wire, and part of the secondary circuit of a straight wire near and parallel to the first, the other parts of the circuits being at a greater distance from each other.

"It is found that at the instant of sending a current through the straight wire of the primary circuit the galvanometer of the secondary circuit indicates a current in the secondary straight wire in the opposite direction. This is called the induced current. If the primary current is maintained constant, the induced current soon disappears, and the primary current appears to produce no effect on the secondary circuit. If now the primary current is stopped, a secondary current is observed, which is in the same direction as the primary current. Every variation of the primary current produces electromotive force in the secondary circuit. When the primary current increases, the electromotive force is in the opposite direction to the current. When it diminishes, the electromotive force is in the same direction as the current.

"These effects of induction are increased by bringing the two wires nearer together. They are also increased by forming them into two circular or spiral coils placed close together, and still more by placing an iron rod or a bundle of iron wires inside the coils."



(This experiment demonstrates the fundamental principles of the use of magnetizing coils in eddy current testing. The need for a time-varying primary current is clearly indicated. The advantage of close coupling or spacing between the magnetizing coil and test metal surface is also shown. This translates into control of lift-off of probe coils, and preference for high coil-fill factors with encircling-coil eddy current tests. The need for pulsating or alternating primary current is also now evident. Finally, the advantages of using ferrite or iron cores in eddy current probe coils are suggested. Present-day eddy current test systems make full use of each of these principles, enunciated clearly by Faraday in 1831.)

#### 4.2 Faraday's law for induction by motion of the primary circuit<sup>(530)</sup>

"We have seen that when the primary current is maintained constant and at rest the secondary current rapidly disappears. Now, let the primary current be maintained constant, but let the primary straight wire be made to approach the secondary straight wire. During the approach, there will be a secondary current in the opposite direction to the primary. If the primary circuit be moved away from the secondary, there will be a secondary current in the same direction as the primary."

(Two principles are implied by the concept of induction by motion of the primary circuit. The first is that polarized and directional secondary currents can be induced by moving a straight-line primary current over a conducting test surface. Secondly, alternating current could be induced in a conducting secondary circuit or test material when a constant-current primary coil is moved cyclically up and down or side to side over a secondary coil or conducting test surface. Where scanning eddy current tests are required, it is possible that a permanent magnet or a direct-current magnetizing coil could be used to induce eddy currents, without the need for an electronic oscillator or ac power supply. An additional concept implied by this technique of induction would be that of using dc magnetic field detectors to measure the magnitude of secondary current or eddy currents in a conducting

material, under or lagging behind the moving primary coil. The decay rate of dc current measured at a fixed distance behind the moving primary coil. The decay rate of dc current measured at a fixed distance behind the moving primary coil would contain information similar to phase and amplitude data obtained by phase-plane analysis of ac eddy current test systems in common use today. Of course, this type of system would perhaps best be used with very rapid scanning over test surfaces.)

#### 4.3 Faraday's law for induction by motion of the secondary circuit<sup>(530)</sup>

Maxwell states also: "If the secondary circuit be moved, the secondary current is opposite to the primary when the secondary wire is approaching the primary wire, and in the same direction when it is receding from it. In all cases, the direction of the secondary current is such that the mechanical action between the two conductors is opposite to the direction of motion, being a repulsion when the wires are approaching, and an attraction when they are receding. This very important fact was established by Lenz."

(This example suggests that a rapidly-moving conducting test material such as sheet metal in a rolling mill could pass by a stationary test coil carrying direct current which induces flow of current in material both approaching and leaving the area of this local magnetization. Detectors of the eddy current field in either location could respond to local discontinuities or variations in material properties which influence the amplitude and distribution of the eddy currents.)

#### 4.4 Faraday's law for induction by the relative motion of a magnet and the secondary circuit<sup>(530)</sup>

Maxwell continues with: "If we substitute for the primary circuit a magnetic shell, whose edge coincides with the circuit, whose strength is numerically equal to that of the current in the circuit, and whose austral face corresponds to the positive face of the circuit, then the phenomena produced by the relative motion of this shell and the secondary circuit are the same as those observed in the case of the primary circuit." (The coil of the preceding

examples could be replaced by a permanent magnet when relative motion exists between the magnet and test material in eddy current tests, providing adequate secondary current magnitude and speed of motion can be attained.)

#### 4.5 Summary expressions for Faraday's law of induction<sup>(531,534,536)</sup>

Maxwell summarizes the various statements of Faraday's law with the following statements: "When the number of lines of magnetic induction which pass through the secondary circuit in the positive direction is altered, an electromotive force acts round the circuit, which is measured by the rate of decrease of the magnetic induction through the circuit...The intensity of the electromotive force of magneto-electric induction is entirely independent of the nature of the substance of the conductor in which it acts, and also of the nature of the conductor which carries the inducing current...The electromotive force of the induction of one circuit on another is independent of the area of the section of the conductors...The electromotive force produced in a coil of  $n$  windings by a current in a coil of  $m$  windings is proportional to the product  $mn$ ..."

Maxwell finally states the "true law of magneto-induction" in the following terms: "The total electromotive force acting around a circuit at any instant is measured by the rate of decrease of the number of lines of magnetic force which pass through it. When integrated with respect to time, this statement becomes: The time integral of the total electromotive force acting round any circuit, together with the number of lines of magnetic force which pass through the circuit, is a constant quantity...This quantity...may even be called the fundamental quantity in the theory of electromagnetism. Faraday...recognized in the secondary circuit, when in the electromagnetic field, a 'peculiar electrical condition of matter' to which he gave the name of the Electrotonic State."

(This quantity being defined as of most fundamental nature appears to be similar to the concept of 'flux linkages', measured by the product of the number of winding turns and the total magnetic flux enclosed in the winding,  $N\Phi$ . This quantity is also expressed by the term  $MI$ ,

where  $M$  is the potential of the coupled circuits, and  $I$  is the current in any coil winding.)

#### 5. Lenz's 1834 Law Showing Effects Opposing Causes in Electromagnetic Induction<sup>(542)</sup>

Maxwell's narrative of the development of basic electromagnetic theory continues its description of the early years of development as follows: "In 1834, Lenz enunciated the following remarkable relation between the phenomena of mechanical action of electric currents, as defined by Ampere's formula, and the induction of electric currents by the relative motion of conductors.... Lenz's law is as follows:

"If a constant current flows in the primary circuit A, and if, by the motion of A, or of the secondary circuit B, a current is induced in B, the direction of this induced current will be such that, by its electromagnetic action on A, it tends to oppose the relative motion of the circuits."

(Stated more generally, Lenz's law states that the electromagnetic field will act so as to oppose or resist any effort made to change its intensity or configuration. Where mechanical motion causes the change, mechanical force developed within the system will oppose the change. If mechanical motion is absent, electromotive forces will be induced which tend to maintain the status quo, namely to maintain the total flux linkages in the system.)

#### 6. Neumann's 1845 Development of Mathematical Theory of Induction<sup>(542)</sup>

Maxwell's history of developments continues with: "On (Lenz's) law, F. E. Neumann founded his mathematical theory of induction in which he established the mathematical laws of the induced currents due to motion of the primary or secondary conductor. He showed that the quantity  $M$  ... is the same as the electromagnetic potential of one circuit on the other.... We may regard F. E. Neumann, therefore, as having completed for the induction of currents the mathematical treatment which Ampere had applied to their mechanical action."



## 7. Helmholtz 1847 Derivation of Laws of Induction From Conservation of Energy<sup>(543)</sup>

In Maxwell's opinion: "A step of still greater scientific importance was soon after made by Helmholtz in his 'Essay on the Conservation of Force,' and by Sir William Thompson, working somewhat later, but independently of Helmholtz. They showed that the induction of electric currents discovered by Faraday could be mathematically deduced from the electromagnetic actions discovered by Oersted and Ampere by the application of the principle of Conservation of Energy.

## 8. Faraday's Recognition of Electromagnetic Kinetic Energy and Momentum<sup>(546-552)</sup>

Maxwell reports that: "Faraday showed that (the phenomenon of self-induction) and other phenomena which he describes are due to the same inductive action which he had already observed the current to exert on neighboring conductors. In this case, however, the inductive action is exerted on the same conductor which carries the current, and it is so much the more powerful as the wire itself is nearer to the different elements of the current than any other wire can be. He observes, however, that 'the first thought that arises in the mind is that the electricity circulates with something like momentum or inertia in the wire.' Indeed, when we consider one particular wire only, the phenomena are exactly analogous to those of a pipe full of water flowing in a continued stream. If while the stream is flowing we suddenly close the end of the pipe, the momentum of the water produces a sudden pressure, which is much greater than that due to the head of water and may be sufficient to burst the pipe....

"These results show clearly that, if the phenomena are due to momentum, the momentum is certainly not that of the electricity in the wire, because the same wire, conveying the same current, exhibits effects which differ according to its form; and even when its form remains the same, the presence of other bodies such as a piece of iron or a closed metallic circuit, affects the result." (This latter effect is that involved in eddy current testing.)

"It appears, therefore, that a system containing an electric current is a seat of energy of some kind; and since we can form no conception of an electric current except as a kinetic phenomenon, its energy must be kinetic energy, that is to say, the energy which a moving body has by virtue of its motion.

"We have already shown that the electricity in the wire cannot be considered as the moving body in which we are to find this energy, for the energy of a moving body does not depend upon anything external to itself, whereas the presence of other bodies near the current alters its energy.

## 9. Influence of Faraday's Research Upon 19th Century Inventors

Michael Faraday's two-volume work "Experimental Researches in Electricity" influenced numerous investigators and inventors in Europe and the United States from the 1830's to the end of the nineteenth century. This led many others to experiment with electromagnetic effects and to develop many basic inventions such as Morse's telegraph, Bell's telephone, and Edison's many improvements on telegraphic, telephonic, fire alarm, and stock ticker communication systems. Faraday in 1831 also showed before the Royal Society a homopolar generator (a disc rotating between the poles of a large horseshoe magnet) for converting mechanical energy into electric energy. His influence upon inventors with little or no scientific training was very great, for Faraday's accounts of his experiments did not use any complicated mathematical formulas. A biographer of Thomas Edison notes that Faraday appeared to be the Master Experimenter whose laboratory notes communicated the highest intellectual excitement--and hope as well. Faraday's explanations were simple, steeped in the spirit of truthfulness and humility before nature. For Faraday, the natural laws were revealed through experiment. To American inventors, Faraday, poor and self-educated, indifferent to money or titles, exemplified the ethics of a true man of science, whom they could emulate. Thus, during the period from 1831 to about 1875, the inventions made on the basis of Faraday's research were often developed by trial and error, empirically, and step-by-step.

## 10. Maxwell's Proposal for Development of Theory of the Electromagnetic Field<sup>(552)</sup>

Based upon the facts previously summarized in this introduction, James Clerk Maxwell outlines his plan for developing a unified theory of the electromagnetic field, as follows:

"We are therefore led to inquire whether there may not be some motion going on in the space outside the wire, which is not occupied by the electric current, but in which the electromagnetic effects of current are manifested.

"I shall not at present enter on the reasons for looking in one place rather than another for such motions, or for regarding these motions as of one kind than another.

"What I propose now to do is to examine the consequences of the assumption that the phenomena of the electric current are those of a moving system, the motion being communicated from one part of the system to another by forces, that nature and laws of which we do not even attempt to define, because we can eliminate these forces from the equations of motion by the method given by Lagrange for any connected system.

"...I propose to deduce the main structure of the theory of electricity from a dynamical hypothesis of this kind, instead of following the path which has led Weber and other investigators to many remarkable discoveries and experiments, and to conceptions, some of which are as beautiful as they are bold. I have chosen this method because I wish to show that there are other ways of viewing the phenomena which appear to me more satisfactory, and at the same time are more consistent with the methods followed in the preceding parts of this book than those which proceed on the hypothesis of direct action at a distance."

## 11. Maxwell's Equations for Electric Circuits and for Electromagnetic Fields<sup>(578-619)</sup>

Maxwell's remarkable achievement of integrating the available knowledge concerning electromagnetic circuits and fields provides the basis for analysis of all basic eddy current and electromagnetic induction problems--and for most of modern electromagnetic theory. These

simple equations in both integral and differential form were derived by the methods of Lagrange, using relationships from the calculus of variations. Solutions for alternating fields are also available for many configurations of the fields.

It is of interest that simpler techniques, using an 'operational map' have been devised by the author for presenting these types of equations and their derivations in simple form for use by second-year engineering students. Since the equations are available in nearly all basic textbooks on the electromagnetic field, they will not be repeated here. Lord Kelvin devised the solutions of Bessel's equation for the cases of probe coils, for example, and provided the so-called Kelvin functions from which simple cases can be readily calculated by hand or by digital computers.

### 11.1 Development of practical electromagnetic induction test methods

It has been reported that Hughes demonstrated the basic features of eddy current nondestructive testing in the 1860's showing that it was possible to differentiate between metallic conducting coins by a simple arrangement of magnetizing coil and induction of eddy currents in the coins.

### 12. Early Tests for Eddy Current and Hysteresis Losses in Electrical Steel Sheets

Active practical interest in use of electromagnetic means for sorting of metals and detection of discontinuities did not result in many useful test devices prior to the beginning of the twentieth century. However, the numerous developments including that of alternating current electric power systems, and the use of transformers and other induction machines, provided a base of practical design and a need to investigate the losses occurring in magnetic core materials used in these devices. Much effort was devoted to reduction of eddy current and magnetic hysteresis losses in laminated steel sheets, particularly by addition of silicon and other alloying elements which lowered their electrical conductivity and use of purer iron alloys with, in some cases, directional rolling to attain maximum permeability and minimum hysteresis losses.



To a first approximation, in cores formed of thin magnetic laminations, it was shown that eddy current losses tended to increase in proportion with the square of the frequency, and hysteresis losses in accordance with the 1.6th power of the frequency of alternation of the magnetic field intensity. Numerous laboratories, including those of electrical equipment manufacturers such as Westinghouse and The General Electric Company, and of manufacturers of electrical steel sheets such as Allegheny-Ludlum and Armco Steel Company, established measurement laboratories to monitor properties of production steel sheets and assure specified electromagnetic loss factors for electrical steel sheets. The well-known Epstein test, and many others, were used for these material tests.

Many improvements resulted, including use of thinner sheets, use of oriented steel sheets, and use of insulating coatings between sheets to limit eddy current flow paths. Also discovered during these magnetic core improvements were the undesirable effects of mechanical clamping stresses and stresses resulting from punching and shearing of laminations, which tended to increase core losses under ac excitation. Hydrogen annealing and other techniques, such as those developed by Dr. Trigvie Yensen of Westinghouse Research Laboratories, led to improved materials such as Hypersil, Hypernik, and other magnetic sheet alloys with superior properties. Control of other alloying elements, additions of up to 50% nickel, and orientation of grain structures and magnetic domains were used to develop special steels with rectangular hysteresis loops which are used in magnetic switching of electrical currents, saturable reactors and magnetic amplifiers, and many novel electromagnetic devices. These developments illustrated the variations in electrical conductivity, magnetic permeability, grain orientation and anisotropy, mechanical stresses, alloy contents, and impurity contents, which influenced the electromagnetic response of ferromagnetic materials and changed the apparent inductance and resistive losses measured by their magnetizing coils. The use of direct-current bias to adjust the apparent inductance in saturable reactors and transductors for power control purposes also illustrated a means for reducing magnetic permeability and incremental inductance or inductive reactance. It was also observed that many magnetic

core materials introduced odd harmonics into the magnetizing currents or voltages across inductances of their magnetizing coils (or into unloaded secondary windings on the cores), and the high sensitivity of the harmonic signals to material conditions and mechanical stressing were known and purposely avoided where possible.

These various effects, well-known to electrical designers at the turn of the century, have since become possible methods for control or read-out of eddy current nondestructive test signals. (However, in general, the highly-permeable electrical steel sheets now commercially-available are not ideal for eddy current tests since their eddy current losses are so very low. For their evaluation, electromagnetic induction tests responsive primarily to hysteresis effects, including higher harmonic effects, may prove more useful.)

### 13. Development of Techniques for Analysis of Inductive ac Electrical Circuits

The sinusoidal oscillations of alternating-current electric power system voltages and currents introduced new complexities in analysis of circuit performance, as compared with analyses for Edison's earlier direct-current electric power systems. As early as 1893, Professors Crehore and Beddell of Cornell University prepared a textbook of analysis of ac electric circuits, including effects of resistive, capacitive, and inductive circuit elements. This book was based upon detailed solution of the differential equations developed by Maxwell, and involved use of calculus in each solution. Soon thereafter, Steinmetz came to the United States with the Thomson-Houston Company (later General Electric Company) and he developed much simplified methods of analysis using rotating line segments which he called "vectors" (now called sinors) to represent sinusoidal quantities. As such line segments rotated about one end (at the origin of coordinates), their vertical projections mapped out the ordinates of the sinusoidal waves, when these vertical projections were plotted as functions of time. Together with the technique of representing impedances on a complex plane (with resistance  $R$  as a horizontal coordinate, and inductive reactance,  $X$ , as a vertical coordinate), the use of these phasor quantities reduced the



solutions for steady state alternating currents to simple algebra and trigonometry, rather than integral calculus. These methods of signal analysis on the complex plane are widely used today in analysis of eddy current tests, following their clear enunciation by Dr. Friedrich Förster of West Germany, following World War II.

#### 14. Early Industrial Development of Electromagnetic Induction Comparators

Numerous electromagnetic induction or eddy current comparators were patented in the United States in the period from 1925 until the end of World War II in 1945. Many of these were referenced in 1950 by McMaster and Wenk in an ASTM publication, updating a prior (1948) summary of basic nondestructive test methods. (See Tables I, II and Appendix I.) Innumerable examples of comparator tests were reported in the literature and in patents. Many provided simple comparator coils into which round bars or other test objects were placed, producing simple changes in amplitudes of test signals, or unbalancing simple bridge circuits. In nearly all cases, and particularly where ferromagnetic test materials were involved, no quantitative analyses of test-object dimensions, properties, or discontinuities were possible with such instruments. Often, difficulties were encountered in reproducing test results, since some test circuits were adjusted or "balanced" to optimize signal differences between a "known good test object" and a "known defective test object," for each group of objects to be tested. Little or no correlation could then be obtained between various types of specimens, each type having been compared to an arbitrarily-selected specimen of the same specific type.

Many simple comparators operated on 60 Hz alternating current from 110 volt ac circuits, using conventional instruments such as voltmeters, ammeters, wattmeters and, occasionally phase meters. Such meters typically absorbed energy from the test circuits, and had typical accuracies and reproducibilities often of only 1% or 2% of full-scale readings. In other cases, well-known Wheatstone bridge circuits were employed to balance out comparison test arrangements, and to provide greater sensitivity to signal differences. For the most

part, many of these early comparator systems were short-lived, and received little acceptance in industry. By comparison, a few such developments, sponsored by major industries or persistent creative inventors who sought support and set up their own companies, survived and are used in their modernized form in American industry today.

#### 14.1 1925-1945 American developments of electromagnetic tests for steel products

Examples of continuing development of electromagnetic induction tests for use in inspection of round bars, tubes, billets, and products of the steel industry of the United States were those of Magnetic Analysis Corporation and Republic Steel Corporation. Both are based upon the continuing efforts of a few dedicated individuals who passed their skills and enthusiasms along to their successors in the same development organizations. Charles W. Burroughs, Carl Kinsley, and Theodore W. Zuschlag were among the pioneers of the Magnetic Analysis Corporation, whose test products are still commercially available in 1978. Archibald H. Davis, Horace G. Knerr, and Alfred R. Sharples received basic patents for Steel and Tubes, Inc. (now Republic Steel Corporation). Their developments were extended and continued in the Electromechanical Research Laboratory of Republic Steel in Cleveland by Cecil Farrow, Archibald W. Black, William C. Harmon, and Joseph Mandula to the large-scale, automated, production-line eddy current test machines for tubes, bars, and billets in use today. (Other steel companies had early inventors and developers of electromagnetic tests but, in many cases, their managements did not support their continuing developments over a period long enough to achieve practical applications.) Within the General Electric Company, an early sequence of inventive development was pioneered by men like James A. Sams, Charles D. Moriarity, and H. D. Roop. Ross Gunn of the U. S. Naval Research Laboratory pioneered a new form of probe-coil magnetizing system with two small-diameter pickup coils displaced symmetrically along a diameter of the magnetizing coil. This was an early example of use of one size of coil for magnetization, and of pickup coils of much different size, in non-concentric positions. (See Tables I and II for details of operation of these test systems, and for other examples from this period.)

## 14.2 Post World War II developments in electromagnetic induction tests

Rapid technological developments prior to and during World War II (1941-1945) in many fields contributed both to the demand for nondestructive tests and to the development of advanced test methods. Radar and sonar systems made acceptable the viewing of test data as images on the screens of cathode-ray tubes or oscilloscopes. Developments in electronic instrumentation, and in magnetic sensors used both for de-gaussing ships and for actuating magnetic mines, brought a resurgence of activity. After the war ended, developments such as Professor Floyd Firestone's "supersonic reflectoscope" for ultrasonic testing, and Dr. Friedrich Förster's advanced eddy current and magnetometer systems, became available as industrial nondestructive testing systems. These systems offered new dimensions for nondestructive measurement both of material properties and of discontinuity locations and relative sizes. The ten-year lag (from 1945 to about 1955) in industrial management's acceptance of novel developments was uniquely short, in the case of these instruments. Electronic instrumentation based upon vacuum and gas-filled electron tubes was approaching the peak of its development. These developments permitted easy construction of variable-frequency oscillators and power supplies for the magnetizing coils of eddy current test systems. They also permitted minute voltage or current signals to be amplified linearly to levels adequate for display systems, graphic and permanent recording systems, and for operation of sorting gates, automation of scanning, and mechanization of materials handling during tests. Aerospace and nuclear power industries were developing rapidly, and made unique demands for sensitivity and reliability of instruments for materials evaluation and reliability assurance during service. These industries (and government agencies related to these industries) were the primary sponsors of research to advance the art of all forms of nondestructive testing. However, in the case of eddy current instrumentation, governmental support was significantly less than in other fields of nondestructive testing, for two reasons which are discussed next.

## 15. Development of Quantitative Eddy Current Test Systems By Institut Dr. Förster

By far the most important factor contributing to the rapid development and industrial acceptance of electromagnetic induction and eddy current tests during the 1950-1965 period in the United States was the introduction of sophisticated, stable, quantitative test equipment, and of practical methods for analysis of quantitative test signals on the complex plane, by Dr. Friedrich Förster. Dr. Förster is rightly identified as the 'father of modern eddy current testing.' His experience prior to World War II included advanced university education in physics and a significant introduction to electromagnetic measurements related to the metallurgy and structure of steels and non-ferrous metals in German research institutes. During World War II, this advanced knowledge was used in naval warfare, particularly with respect to magnetic mines. At the conclusion of the war, after a period of imprisonment by the French, Dr. Förster retrieved his technical reports and, "with the aid of a screwdriver and a technician," began his further development of electromagnetic test instruments in the upper story of an old inn just a few miles from Reutlingen, where he later established his Institut Dr. Förster. By 1950, he had developed precise theory for many basic types of eddy current tests, including both absolute and differential or comparator test systems, and probe or fork coil systems used with thin sheets and extended surfaces. Painstaking calibration tests were made with these coil systems and with mercury models (in which defects could be simulated by insertion of small pieces of insulators). Each test was confirmed also by precise solution of Maxwell's differential equations for the various boundary conditions involved with coils and test objects, at least for symmetrical cases such as round bars, tubes, and flat sheets where such mathematical integrations were feasible. Further studies were made of the non-linear response characteristics of ferromagnetic test objects, and methods utilizing very low test frequencies (5 Hz), harmonic signal analysis, comparators at various levels of magnetization, and precise bridge circuits were developed. In most instances, Dr. Förster replaced measurements of the inductance or



impedance of test magnetizing coils with the more precise technique of measuring response with unloaded 'secondary coils' coupled to the test materials almost identically with the magnetizing coils. The extent and depth of these scientific studies were not matched by any laboratory in the United States, whether under government sponsorship or operating independently. By extensive publications (not initially in the form of U. S. Patents, but in the open literature), Dr. Förster made the end results of this research available to the world of technical personnel. His monumental contribution of almost the entire theory and technology of electromagnetic induction and eddy current test techniques to the ASNT Nondestructive Testing Handbook in the 1955-1959 period provided the means for educating thousands of other nondestructive test personnel in the theory, methods, equipment, and interpretation of eddy current tests. This integrated presentation was then used throughout the world to update eddy current test technology.

#### 16. Importation of Dr. Förster's Eddy Current Technology to the United States

The unique developments in Dr. Förster's new laboratory in Reutlingen, West Germany, were made known in the United States, not only by those capable of reading his publications (in German) prior to 1950, but also by missions in which American personnel were sent to Dr. Förster's laboratory for education and experience with these new forms of test instrumentation. Richard Hochschild, for example, made a visit of perhaps six months in Reutlingen. Upon his return, he prepared summary reports which were distributed by the AEC sponsors of his visit. Other personnel from private industry and from other laboratories made visits to learn of these new techniques. In the United States, numerous facilities began research to test these new concepts and instrumentation, including significant efforts at Oak Ridge National Laboratories, at the Hanford Works, and in other facilities. The splendid creative work of Mr. Hugo L. Libby at Hanford during the past quarter century, and that of Robert Oliver, Robert McClung, Caius V. Dodd, J. A. Deeds, and others at Oak Ridge, which have continued into the 1970's, may well have initially been inspired (and sponsored in response to) the new work done by Dr. Förster.

However, even more significant has been the complete transfer of Dr. Förster's advanced technology to enterprising American firms manufacturing and distributing nondestructive testing equipment, since 1952. As many of you may remember, Dr. Förster made his first presentation before an ASNT audience early in the 1950's, after learning aboard ship about five words of English, namely: "Sonny boy" and "I love you." This first personal presentation in the United States was followed by meetings with management of the Magnaflux Corporation, in which the author served as a technical advisor to explain Dr. Förster's designs and discussion. Agreements for licensing under Förster patents were later concluded, and the basic Förster instruments were "Americanized" by use of U.S. components and electron tubes, for Magnaflux, by the NDT staff at Battelle Memorial Institute in Columbus, Ohio. (Here, again, the author had an opportunity to become aware of the remarkable character of these new instruments.) During the next few years, increasing amounts of technology were transferred to Magnaflux, whose staff (under Dr. Glenn L. McClurg) became qualified in the design and production of Dr. Förster's various instruments, and then marketed these electromagnetic induction test systems throughout the United States.

#### 17. Proliferation of Sources of Eddy Current Equipment Derived from Dr. Förster

The collaboration between Dr. Förster and the Magnaflux Corporation lasted perhaps ten years, during which rapid progress was made in both the German laboratory and in the United States in advancing the art of eddy current testing. Upon completion of the arrangement with Magnaflux, Dr. Förster marketed his instruments through the Förster-Hoover organization in Ann Arbor, Michigan. Rudy Hentschel, who was trained in Reutlingen at Institut Dr. Förster, provided information transfer to this new organization. (More recently, he has developed similar advanced instruments at his own facility in Ann Arbor.) After a few years, the licensing of Förster instruments to Automation Industries, Inc. resulted in further transfer to advanced technology, and marketing of equipment throughout a new organization. The most recent arrangement with Krautkramer-Branson has repeated this

unique educational process. At present, the large organizations manufacturing many types of nondestructive testing equipment and marketing their services widely in the United States are presenting updated versions of Dr. Förster's basic test instruments and modifications developed by their own staffs. Also in the market are the instruments developed by Magnetic Analysis Corporation, those based upon Hugo Libby's research at Hanford (by Nortec), those based upon the Oak Ridge Laboratory research and developments by Richard Hochschild and Donald Erdman (which have migrated from the originators through the Budd Company, Automation Industries, and Tech-Tran in recent years). Basically, in 1977, these various brands of conventional eddy current instruments are redundant and similar in nature, having been updated to semiconductor circuit elements and more recently to integrated circuits in some cases. With the typical instruments used to cover various needs and applications, the presently-available instruments operate with absolute or differential probe coils, encircling coils, internal bobbin coils, and various special coil and circuit arrangements, many of which were described in the 1959 ASNT Nondestructive Testing Handbook by Dr. Förster. Self-balancing or adjusting instruments, which establish reference points simply by the placing of probes upon reference test materials or specimens, are available in several cases, utilizing developments by Hugo Libby and other innovators. Designs of probes based upon digital computer analyses of eddy current distributions in single- or multiple-layer sheet materials have been made feasible through the pioneering work at the Oak Ridge National Laboratory. Special probes with split coils, internal magnetic shields, and other complexities have also been developed for crack detection and other special applications. Digital displays of test signals are also being introduced.

#### 18. Introduction of Microwave Nondestructive Test and Measuring Systems

At very high frequencies, electromagnetic fields can be concentrated into beams and propagated through space. When such a beam pulse strikes a conducting metallic surface, for example, it is reflected and may return as an echo to the site of the original pulse transmitter, or to other detectors, as in radar detection. In dielectric materials, microwaves can

be subject to rotations and phase shifts, as well as to attenuation due to dielectric hysteresis losses. In many ways, microwave nondestructive test systems are analogous in performance applications to immersion ultrasonic test systems. By Maxwell's theory of the electromagnetic field, microwaves are reflected like light waves by eddy currents induced in the surface layers of highly-conducting metallic materials. Thus, microwaves appear to have the capacity to apply high-frequency eddy current tests to a metallic surface from a distance, and perhaps to scan such surfaces to detect discontinuities which change the pulse-reflection patterns.

When the Radac eddy current systems were sold to the Budd Company, Richard Hochschild turned his attention to formation and development of Microwave Instruments Company in Corona del Mar, California. Soon a series of instrument systems had been developed, and the long task of educating industrial and scientific users in the capabilities and applications of electromagnetic tests had to be done all over again for these new higher frequencies. Of course, the theory and design of microwave generators, horns, antennas, detectors, and display systems had been previously developed for long-distance ranging in radar. Many textbooks presented the electromagnetic theory of microwaves in terms readily used by electrical engineers. Microwave system components and electron tubes were commercially available. However, these electrical engineers rarely were aware of the needs of nondestructive test engineers, and NDT engineers had little familiarity with microwaves. In fact, many NDT personnel were still struggling to catch up with the art of eddy current testing at the lower frequencies, as explained by Dr. Förster. After several years of diligent development and continued application research and marketing efforts with the assistance of Ron Botsco, Microwave Instruments Company was sold and its proprietor moved to greener pastures in the area of medical services. A few other organizations built simple microwave test systems, but the development of industrial microwave nondestructive testing has been languishing during the 1970's. Limited research sponsored by ARPA and other government agencies has resulted in indications of possibilities of crack detection from a distance, since slots and wires simulating discontinuities in metallic test object surfaces can be detected under proper conditions of microwave



pulse-reflection testing. (The theory of microwave antennas and of time-domain reflectometry of microwaves in tubes, passing along wires, and reflecting and refracting in dielectric layers, offer many indications of potentially-valuable nondestructive test applications.) Since microwaves can be focused, microwave systems could also potentially be designed analogous to optical instruments and test systems, as well as ultrasonic test systems. However, in 1978, there appears to be no significant commercial development or application of microwave nondestructive tests in progress.

On the other hand, a large-scale example of microwave exploration of objects at great distances is occurring in radio astronomy laboratories throughout the world. For example, Professor John D. Kraus of The Ohio State University has constructed a large radio telescope in Delaware, Ohio, and is using it continuously to map the universe of radio stars and objects which emit microwave signals. The mapping has progressed to where many radio sources found have been confirmed by films from optical telescopes, and others have been predicted in location. Possibilities of emissions from galaxies, 'black holes', and other astronomical features still exist. Professor Kraus has recognized this as a form of "nondestructive testing of outer space" and has written a delightful biographical book "The Big Ear," which summarizes a lifetime of study and applications of Maxwell's theory of electromagnetic fields in clear and simple words.

#### 19. Advantages of Eddy Current Test Systems Commercially Available in 1977-78

The eddy current test systems available commercially in 1978 have many advantages which justify their present wide usage. One great advantage is the reproducibility of measurements possible with many well-built instruments and test systems. Absolute conductivity meters and instruments designed for thickness measurements of specific metals and alloys are often quantitative and can have accuracies of 1% or better. Comparison instruments permit unique sensitivities for detection of discontinuities and of variations in material geometries or properties. With stable reference specimens, tests can also be repeated with a high degree of confidence. Instruments with phase and amplitude signal capabilities

which duplicate phase-plane data consistently permit a wide range of interpretations to be made, depending upon the strategic test conditions selected. Phase separation of signals to suppress unwanted signals and provide desired signals without interfering effects are especially valuable where consistency of geometry and physical properties of test materials permit their use. The general use of reference standards with drilled holes, milled or EDM slots, stepped wall thicknesses, and certain natural defects provides a quick means of assuring proper operation during testing, or of calibration and adjustment of control settings at the beginning of test sequences on objects of a particular type or material. These advantages generally accrue with nonferromagnetic test materials and symmetrical simple shapes of test objects. They cannot always be attained with magnetizable test materials or with parts of complex geometry where reproducible positioning may not be feasible.

By use of magnetic bias (or 'saturation magnetization'), depths of penetration of eddy currents and a.c. magnetic fields into ferromagnetic materials can be greatly increased. Many simple detectors of surface discontinuities operate quite effectively during automatic scanning despite difficulties due to surface roughness or variations in hardness or magnetic permeabilities in test objects. Large-scale through-coil test systems for smaller-diameter rounds and tubes, and orbiting probe coil systems used with rods, welded tubes, and even rectangular billets have been developed to a high degree of ruggedness, serviceability, and reliability for use in steel mills and on large-volume inspection applications. Automatic marking of defect locations permits salvage by grinding out and welding repair (if the latter is needed) on production line operations. Detection of defects in surface layers of steels is well-developed, but measurement of physical or metallurgical properties of steels is generally not feasible by eddy current tests in the United States. One basic source of difficulty is the sequential use of sheets, tubes, or rounds from different mills or different heats, in rapid succession on production lines. Although the chemical and physical properties of these steels from different sources may meet manufacturing requirements adequately, no effort is made to control the magnetic permeability properties of these steels to any type of calibrated standard. As a



consequence, random variations in magnetic permeability prohibit the development of reproducible correlations between absolute measurements of eddy current test signals and the actual physical or metallurgical structures of the test objects.

High sensitivity to material electrical conductivity (in nonferromagnetic materials) has been attained with small probe coil test instruments typically operating in the range of 64 kHz test frequencies. Such small coil probes tend to be sensitive to lift-off, and 'lift-off compensation systems' such as those developed by Dr. Förster are often used to correct lift-off effects over a small range. Similarly, small differential coil or field detector systems provide high sensitivity to surface cracks in both non-magnetic and in ferromagnetic materials. However, in general, for such crack detection, manual positioning and scanning with these fine probes is usually required on nonsymmetrical part surfaces or materials in service structures and machines. There is no low-cost means for total inspection for cracks on parts with complex surfaces, such as those for which liquid penetrant tests (or magnetic particle tests on iron or steel parts) provide overall surface inspection at high speed and low costs.

#### 20. Limitations and Disadvantages of Presently-Available Eddy Current Test Systems

The primary disadvantage of eddy current test systems available in 1977-78 is the fact that their test indications are psychologically-unacceptable. They are far less effective in stimulating management and worker comprehension and corrective action than the graphic images provided by other processes such as liquid-penetrant, magnetic-particle, or x-ray inspection, for example. These eddy current tests fail to produce a clear, visible, interpretable image of defects or discontinuities from which an almost-instant recognition of their nature, shape, size, or location is obvious to all observers. Thus, where the purpose of nondestructive testing is to motivate personnel to best efforts or to permit immediate correction or repair of defects, eddy current tests which produce fugitive traces on cathode-ray tube screens or 'meaningless' movements of the needle of a panel instrument, are quite ineffective. Secondly, even when these tests are used

to measure material properties or dimensions, the fact that the quantitative displays of signal amplitudes, component values, or phase angles have no direct meaning to the untrained observer acts to create doubt. When numbers have to be 'looked up in a book or chart' to find the real meaning of test indications, the opportunity exists for human errors. In addition, since the same book or chart would not be valid for materials other than a specific material for which the chart is designed, untrained observers will question the results. If modern eddy current tests provided clear, informative images or direct read-outs in numbers of a specific dimension, property, or service characteristic (which could be immediately checked on reference samples if needed), their use could be multiplied indefinitely. For example, where today x-ray or ultrasonic tests are specified for control of weldments, no one dares to trust eddy current measurements of these same welds for control of welding operators or for acceptance of the welds for specific service conditions.

The second disadvantage of present eddy current test systems is that they are greatly limited by artificial constraints inherent in the thinking of present designers, manufacturers, and users of these tests. No one has made any fundamental change from the basic designs which Dr. Förster provided in 1955, nor in the methods for interpreting test signals. Because of these unnecessary constraints adopted by tradition, eddy current tests are far less informative or sensitive than they should be. Examples of such mental straight-jackets are cited in a succeeding paragraph. True advancement to the next era of eddy current testing cannot occur until the responsible and active engineers, management, and test personnel develop systems to utilize the full capabilities of the method and use these systems for effective control of people, processes, products, and in-service materials and systems.

The third disadvantage of present eddy current test systems is that they are limited in penetration depths (often to less than 5 or 10 mm) and in magnetizing coil and detector adaptability to rough or contoured test material surfaces. Few probes or test coils are designed to fit into a sharp inside corner or intimately to the outer edge of a sheet material, for example. In general, many probe coils are on rigid forms, and cannot conform to

irregular contours on test objects. It is also often assumed that small-diameter probe coils must be used to measure fine defects or the properties of small areas of test objects. Yet, small coils assure lack of deep penetration of the magnetic field into metals or alloys (since the coil field in air is proportionately small).

The fourth disadvantage of present eddy current test systems is their insensitivity to local conditions or discontinuities which produce only small distortions in eddy current flow paths. (In this sense, "small" is related to the diameter of the test coil.) In general, present test systems do not detect discontinuities or defects which lie outside the perimeter of the test coils. They are also typically insensitive to small defects which lie on the centerline of the test coils. In fact, existing test coils integrate all magnetic flux lines which their winding turns enclose. With discontinuities small in dimensions compared to the coil diameter, the defect signals are submerged in a large average coil signal so that highly-sensitive detector circuits are needed to detect the minute changes in amplitude or phase. Even worse, present coil-type detectors are insensitive to the tilt or angle of magnetic flux lines encircled by the coils. They simply measure the time rate of change of the total magnetic flux enclosed by the test coil. This often loses signal magnitude by ratios as great as 100 to 1. Finally, the use of coils for detection of signals limits the most minute area detectable to that roughly corresponding to the pick-up coil diameter (or the diameter of a ferromagnetic core within the pick-up coil.) Modern microelectronics can far exceed these limitations on reducing the size of test area whose electromagnetic test signal is detected and displayed.

The fifth disadvantage of present eddy current test systems is their limitation to higher test frequencies and to tests at larger phase angles on the complex plane. The voltage signal amplitude provided by a pickup coil is proportional to the test frequency. If an effort is made to operate at very low test frequencies to attain deeper penetration and response to 'rear-surface' conditions, the signal can become too low to detect in the presence of normal noise signals. Even if amplification can permit signal display, the low-frequency test condition leads to signal points on the upper left portion of

the locus curves of response on the complex plane. Here, the signal closely approaches the 'empty-coil signal' in both amplitude and phase. The small contribution of the eddy current losses to this test signal also imply lack of test sensitivity.

The sixth disadvantage of some present eddy current test systems is the variation of magnetizing current amplitude with test frequency. Higher test frequencies require higher power supply voltages to provide a given magnitude of current in the test coils. If variations in test frequency result in inverse changes in magnetizing current, tests may be made on ferromagnetic test parts at widely-different levels of maximum magnetization, at different test frequencies. This can create difficulties with harmonic signal generation and non-linear response characteristics in eddy current test measurements. Alternatively, if true constant-current magnetization levels cannot be provided as frequency varies over a wide range, the designer may limit the test instrument to one or a few discrete test frequencies for which constant current levels can be assured. Even when multi-frequency tests are made at these few frequencies, a loss of information at other intermediate frequencies results.

A final limitation of some present eddy current test systems is their use of sinusoidal continuous ac current excitations. A useful signal thus lost is that of magnetic retentivity, and its relation to eddy current pulse decay characteristics. Square wave or spike excitation can provide both retentivity signals and decay curves for eddy currents within the test materials. The use of coil-type pickups prevents detection of the dc components of test signals which could be generated with pulse or rectangular waveshapes, since response is zero to steady-state magnetic flux conditions.

## 21. Artificial Constraints in Design and Use of Eddy Current Test Systems

Possible present stagnation in development of new or unique forms of eddy current test systems could result from constraints in thinking about novel approaches, perhaps because these new concepts are not fully documented in the past history of eddy current inspection. For example, circular test coils were selected for initial investigations because they



were easy to build and many test objects had circular symmetry. Theory also has been directed to circular test coils since the solutions of Maxwell's equations for the electromagnetic field could be attained more easily with symmetric circular boundary conditions (such as can be solved with Bessel's equation and its modifications). Actually, however, test coils can be wound around square, triangular, or spherical forms. They could be made highly flexible so that they can be made to conform to surfaces of any shape. In all cases, advantages accrue in eddy current testing if the magnetizing coil lift-off can be minimized. Flexible magnetizing coils with stranded conductors imbedded in rubber-like sheets or tubes might offer considerable advantages. Applied under pneumatic or other pressure, such flexible sheet magnetizing coils could be fitted to gently curved test parts with essentially zero lift-off. If the detector coil could also be in intimate contact with the curved surface of the test object, maximum test sensitivity and elimination of non-uniform lift-off conditions could be attained.

A further typical constraint lies in the assumption that the magnetizing coil and the pick-up coil should be either (a) one and the same coil, or (2) of identical diameter and coincident in position. True, the literature describes such simple arrangements redundantly. However, the pickup coil could be of any diameter (preferably smaller than the magnetizing coil), and be placed at any angle and in any desired position with respect to the magnetizing coil. For example, the pick-up coil could be located at any point, and in any orientation, within or completely outside the annulus of the magnetizing coil, or even at a point directly under only one point of the magnetizing coil winding. In fact, if the pickup coil is replaced by a semiconductor magnetic field detector, total freedom exists with respect to the number, positions, and angulations selected for the individual semiconductor detector elements. For example, an array of semiconductor detectors could be placed anywhere within, under, or external to the magnetizing coil windings to provide a multiplicity of input signals with only one magnetizing coil. Ideally, such an array should cover the entire area enclosed within the magnetizing coil or be extended over an area much larger than the magnetizing coil to provide total test information concerning the entire eddy current test field created

by the magnetizing coil. If this detector array could be interrogated in sequence by rapid techniques such as used to read computer memories or to digitalize images, for example, the resultant multi-channel data could be analyzed by digital techniques, and displayed in any desired image format (including two- or three-dimensional images on a television screen).

A particularly desirable change from prior art would be to utilize very large diameter magnetizing coils closely fitting test-object contours, to assure deep geometrical penetration of the magnetizing field. For example, a 10 in diameter test coil could easily project strong magnetic fields 2 or 3 inches in front of the coil face. Used with lower test frequencies, such a coil might provide penetration through 1 or 2 inches of nonmagnetic test material (particularly in the case of materials with electrical conductivities less than about 10% IACS). With arrays of semiconductor type magnetic field detectors, detail sensitivity to near-surface discontinuities might become sufficient to provide good recognizable images of typical discontinuities and defects. Alternatively, a linear array of magnetic field detectors might scan linearly across the field, or be rotated to provide a circular scan of the field within or adjacent to the magnetizing coil. The instantaneous appearance of a recognizable eddy current image of defects would convert this test into a psychologically-acceptable test and greatly increase demand and use for eddy current tests. The repeatability of such images, as coil and probes are moved over test surfaces, or tests are repeated after a time period, would do much to establish confidence in the reliability of such images. In general, the instantaneous character of eddy current images and the ease with which depth sensitivity could be changed or polarized eddy current flow established, might compare favorably with x-ray or ultrasonic test images of welds or with fluorescent penetrant or magnetic particle tests of surface cracks or seams and laps.

Another potentially attractive technique is that of using differential probe signal pick-ups (preferably by detecting unbalance in a four-detector array analogous to a Wheatstone bridge) which would be a direct map of the flow of eddy currents below test surfaces. The reality of eddy current flow paths and their deviations caused by discontinuities could then



be visualized readily. Since local detectors in the vicinity of crack ends, for example, can have surprisingly large test signals (as compared to those of large-area pick-up coils), unique opportunities exist for precise measurements of crack lengths and of crack extension rates. These topics are of special interest where fracture mechanics analyses are to be made of cracks to determine their capability to propagate under service stresses.

## 22. The Pending Revolution in Microprocessor Control of Eddy Current Tests

Already upon us in the 1977-78 time period is the explosion of use of microprocessors and digital computer techniques as integral components of nondestructive test systems and controls. The costs of these components have become so low that they are now toys for amateurs like the older "ham" radio operators. Home computers are available in the corner computer store which rival large-scale digital computers of just a few years ago. Microprocessors have already invaded control of ignition and carburetors in automobiles or domestic appliances in the house-wives' kitchens. They are urgently needed in eddy current instruments, where EPROMs (erasable read-only program memories) can be dedicated to specific purposes, such as providing direct correlations of eddy current test signals with material dimensions or properties. Since small test instruments could now be made direct reading for any valid measurements by eddy currents, the old business of table look-up or intelligent interpretation has become obsolete. The advantages are obvious in that each purpose could involve a separate low-cost test instrument, or plug-in PROM's could be used to change the correlation data from one test material to another or from one test frequency to another.

The additional advantages to be attained by integration of microprocessors and computers into eddy current test instrumentation are the possibilities for much more sophisticated real-time analysis of test signals. Positions of signal points could be determined on the complex planes, the directions of signal change established in response to each test material variable, and undesired signal components could be eliminated, without the

use of the analogue circuits used previously for such purposes. In addition, incoming test data could be continuously compared with prior data (from the same or other test objects) to detect and define differences resulting from discontinuities or changes in material properties. A further operation of data-smoothing as point-by-point data are entered into memory could add an additional degree of precision. Simple extrapolation or interpolation estimates could be derived from test data so that changes in trends could be detected rapidly as tests progress. Of course, differential measurements, or comparison measurements, could be made also from absolute input signals, thus eliminating the need for several test arrangements (absolute, differential, or comparison coils) to attain full information from eddy current tests.

A further natural consequence of use of digital techniques in data collection and analysis would be the possibilities for real-time control systems based upon eddy current test inputs. Recognition of material damage in service, high stress levels, or high temperature effects could be used to shut down or control systems to prevent premature failures. In addition, in processes such as fusion welding, a multiplicity of eddy current detectors could be used to monitor and control the welding process. Input signals might be derived from changing conditions such as material thickness, edge or weld groove distance, conductivity of metal, temperature of metal, depth of penetration of fusion, and final weld inspection for root defects, undercutting, cracking, lack of penetration at the root, and other undesired conditions. Other similar production control applications could be cited.

Still another advantage could be attained in telemetering and storage of eddy current test data. Digital data could be stored in computer memory, transferred to magnetic tapes, floppy discs, or other large-scale memories, and used as permanent inspection records (much as data on nuclear pressure vessels obtained by ultrasonic tests are digitized and stored today). In addition, digital data storage may in the future permit direct correlation of conditions detected by one type of test (such as ultrasonics) with another type of test (such as eddy currents).

### 23. Future Development of Direct-Imaging Eddy Current Test Systems

As noted earlier, the greatest limitation of eddy current tests, as compared with more popular tests like x-ray, penetrant, magnetic particle, and C-scan ultrasonic tests, is the lack of interpretable images derived from eddy current tests. Of course, there is no reason why eddy current test probes could not be scanned over test-object surfaces, just as is now done in immersion ultrasonics to establish C-scan (or plan view) images showing defect locations on the test surfaces. However, such scanning is slow and costly which inhibits its use even with ultrasonic testing. If eddy current tests could provide instant images (somewhat like x-ray fluoroscopy) or permit recording of test information so that it could be displayed on the face of a cathode-ray tube like a television picture, the data could become psychologically attractive and understandable to many more observers. In addition, if eddy current test images could be informative of conditions through much greater metal thicknesses so as to compete effectively with x-rays and ultrasonics, their usefulness could be increased.

With semiconductor detectors, such as indium-arsenide Hall devices, the detector size can be made quite small (as compared to the diameters of large magnetizing coils). If the semiconductor detectors were formed into arrays (like checkerboards) of perhaps 100 by 100 elements or more, within a magnetizing coil of large diameter, the individual picture elements could then be read-out one-by-one in sequence, just as microprocessor or digital computer images are recorded and reproduced on the X,Y coordinates of a television picture tube screen. (The hobby computers are now often equipped with facilities and programs (in software or PROM's) for such data display as images in color.) Such data could be collected from the detector array, subjected to interpretation criteria, and the results displayed on a full-screen image in short times, such as one or two seconds. They could then be interpreted from the screen, particularly if the microprocessor also presents needed digital data correlations for test conditions and test-object dimensions and properties. Such tasks as determining if discontinuities were located in critical areas of test parts could also be carried out by the microprocessor if critical areas had been identified and

mapped similarly for the specific test objects in advance.

A further potential advantage of television screen imaging of eddy current test signals could be the low-cost, high-speed production of permanent video tape records of all test conditions and results. Such video tapes can be made today on recorders so low in cost that they too are becoming toys in the home. Such video tapes are easily transported and can be played back later and at other locations for review of test results. Video-taped images of standard reference specimens and defects might also be used during visual evaluation of the eddy current test images. Also feasible, in these cases, is digital enhancement of image contrast, and display of enhanced images in various colors or with various brightness levels which could be adjusted for best discrimination of significant discontinuities or defects.

### 24. Future Development of Deep-Penetration Eddy Current Test Systems

The future should see a huge improvement in the depth capabilities of eddy current test systems. At present, most eddy current tests are used for surface and near-surface inspection where they provide high test sensitivities. Uniquely-good performance can be attained with thin-wall test objects, namely those whose metal wall thickness is a small fraction of the eddy current penetration depth. (Eddy current penetration depth is the metal depth at which the eddy current density,  $J$ , is reduced to about 37% of its value at the test material surface closest to the magnetizing coil.) At a depth of three times this penetration depth, the eddy current density is only about 5% of the surface current density. At five times the penetration depth, the eddy current density is negligible at less than 0.5% of its surface intensity. The standard penetration depth is an inverse function of the square root of the product of test frequency, material conductivity, and/or material magnetic permeability. In highly-ferromagnetic test materials, the penetration depths are typically reduced by a factor of 10 to 100, as compared with a nonmagnetic test material.

Improvements in penetration depth are obviously attainable by lowering the test frequency or saturating ferromagnetic materials to lower their relative magnetic



permeability. The first technique, of lowering test frequency, was limited in the past by the difficulty of detecting low test frequencies with pickup signal coils. With semiconductor detector systems, or by adding integrating operational amplifiers to pickup coils so as to integrate the test signals, it should be possible to work at much lower test frequencies. If, as an example, it were feasible to lower a conventional 10 kHz eddy current test frequency to 1 Hz, the standard penetration depth should increase by 100 times. However, at such a low test frequency, it would take one second to complete one cycle of alternation. With modern electronic integration systems, such frequencies are not out of the range of feasible measurements. In fact, low frequency oscillators and analysis systems should be able to handle frequencies as low as 0.01 Hz.

However, increasing the penetration depth by lowering of test frequency is of no value if the magnetizing coil diameter is such that the magnetizing field in air is reduced geometrically so that very few or no flux lines can reach the new penetration depth limits. The answer here is to employ large-diameter magnetizing coils (although the eddy current detectors can be as small as desired). An example of a large-diameter magnetizing coil in present use is the metal detector used to inspect air passengers prior to boarding aircraft in the United States. Such large-size test coils should also conform to surface contours of test objects, where feasible, and provide adequate levels of low-enough test frequencies to meet inspection requirements. Ideally, where feasible, the eddy current test should also result in interpretable images with good psychological impact, so that they can influence both management and workers to their best efforts.

#### 25. Future Development of Time-Domain Reflectometry Eddy Current Tests

Time-domain reflectometry is a well-known technique for detection of discontinuities in high-frequency electromagnetic field transmission lines, telephone and telegraph lines, and by radar. Similar time-domain reflectometry techniques are used in ultrasonic nondestructive testing, and particularly in immersion testing. Short pulses of high-frequency wave trains, or a single step or square wave pulse, can be used. It is also pos-

sible to utilize short electromagnetic pulses in through-transmission electromagnetic testing. For example, Paul Gant of Shell Development Laboratories in Emoryville, California, used such a system many years ago to transmit electromagnetic pulses along oil well drill pipe and steel tubes. Encircling coils used as transmitters and receivers permitted detection of larger discontinuities and of zones of reduced wall thickness. Richard Hochschild also used radar-type echo ranging with his microwave test equipment to establish distances to metallic sheet and other reflectors.

Time domain reflectometry and standing-wave analyses are widely used in high-frequency electronic engineering analyses. Microwave parts and 'plumbing' fixtures are available from electronic equipment manufacturers, for construction of such systems. TDR plug-in hardware is available for high-quality cathode-ray oscilloscopes, which can be used directly for time-domain reflection eddy current tests. In such tests, microwave pulses are transmitted along metallic or dielectric rods, tubes, or sheets. Where impedance mismatch conditions are encountered, reflections occur. These systems are entirely analogous to ultrasonic pulse-reflection tests. Where the electromagnetic waves travel in dielectrics or in air around a metallic conductor, reflection can result from liquid or solid dielectrics (such as ceramics), or from metal surfaces (which typically act as total reflectors). Such techniques might apply for rapid inspection of metallic material moving at high speeds in a rolling mill, or perhaps for inspection of dielectric coatings being applied to wires, tubes, or sheets under fast transport conditions. (The travel speed of waves encountered in typical electromagnetic time domain reflectometry on metallic structures is perhaps two-thirds the speed of light (or about  $2 \times 10^8$  meters per second.) Thus, echoes would return from a reflector one meter from the source in a time period of  $10^{-8}$  seconds or 10 nanoseconds. Precision, fast-response, high-resolution electronic signal detection and analysis equipment, such as a cathode-ray oscilloscope or digital systems, would be needed in most cases (except when standing wave resonance conditions are present).

Further development of the recent efforts to use microwave beams to interrogate metals surfaces at a distance, to detect conditions such as slots or cracks,



highly-conducting surface coatings, dielectric surface coatings, or projections and surface irregularities, is still needed to permit practical test systems to be developed. In a similar sense, use of microwave distance measuring devices to detect movements of structures such as large tanks or bridges during earthquakes or under service loading might also be feasible. The still higher frequency laser beams used to range distances in surveying are similar, since their electromagnetic waves are still shorter in wavelengths than microwaves. As optical waveguides and signal transmission systems improve, it may be possible that these will also be used for analysis of electrical and magnetic properties of materials, and so join the ranks of practical nondestructive test systems.

#### 26. The Ultimate Goal: Intelligent Materials with Microwave Trouble Signals

The ultimate goal with all forms of nondestructive test system development should be that of discovering or developing 'intelligent engineering materials' which detect troubles by themselves and transmit suitable alarm signals in time to permit human control to prevent disastrous failures. The presently-available technique of acoustic emission nondestructive testing is an example of transmission of signals from materials under mechanical stresses or subject to damaging events such as stress corrosion or fatigue damage leading to cracking. Man has not tried very hard to hear the many signals emitted by natural and artificial materials. Recent interest has been directed to earthquake prediction and prediction of dangerous storms. Probably many nondestructive test engineers have not bothered to "listen" to the microwave signals emitted by metallic surfaces and structures under stress, vibration, or surface attack. Yet, engineers often have to work very hard to muffle or destroy these signals when they tend to interfere with intentional human microwave or radio transmissions. For example, it has long been known that railway axles rotating in journal bearings create radio "noise" which is considered objectionable. In fact, copper straps are applied to short-circuit these emissions to assure that they do not interfere with railway signal systems or other communications.

Every citizen who drives a car with a radio has also had an opportunity to ob-

serve the microwave signals from large trucks, bridges, and machinery. If the car radio is tuned between broadcasting stations, so as to receive only "static" noise signals, variations in these signals can be quickly found as his car passes large trucks with metallic bodies, or drives across older iron or steel bridges with loose bolts or connections. If long-distance static is screened out (as in a shielded room), the radio signals from contacts dragging across metal surfaces, or from rotating bearings, or from loosely-bolted joints undergoing vibration, can be heard distinctly. In fact, if while wearing gloves, one taps a knife and fork together while walking about in the vicinity of the radio receiver, he can send Morse code or any other sequence of signals which can be heard on the radio loudspeaker. When two metals rub together, enormous sounds and screeches can be heard as the metals complain of the damage their surfaces are undergoing. When ball or roller bearings rotate under heavy load or with inadequate lubrication, each metal-to-metal contact can be announced by clicks and distinct signals. Often the same sequence of signals is broadcast with each rotation of the shaft or of a ball or roller with a damaged surface. In all cases, the intensity of these signals can be greatly increased by connecting one of the metal surfaces to the antenna lead of the radio (preferably through a shielded cable). The other metal surface may be grounded or allowed to stand insulated from all other surfaces. On the other hand, short-circuiting the two pieces of metal together at the point of signal generation generally extinguishes the radio signals broadcast.

The well-known triboelectric effect (electrification by friction) known by the Greeks 2000 years ago, illustrates the basis of such microwave emissions. During rubbing, one material steals electrons from the other material, particularly when contact is broken. Since the electron cloud within conducting metals constitutes a plasma, the sudden removal or injection of charge locally may create plasma oscillations. If one of the metal pieces is insulated from the other, it is possible that such oscillations result in electromagnetic waves traveling through the metal. It then serves as an antenna to broadcast these waves into the space around it. These weak signals can be easily lost in static conditions. Tests in a shielded room permit their clear identification and their correlation with

material surface characteristics. The author has found these signals to approximate 'white noise', in that they can be detected at all frequencies from those of audio amplifiers, through those of a.m. and f.m. radio broadcasting, to frequencies of 100 MHz or higher. This could be expected from the short time duration involved in the robbery of electrons from a metal surface.

Thus, the ultimate in-service monitor system for metallic systems and machines may well be formed of microwave monitors of electron emissions. When the electron charges are removed from a metal, the eddy current reaction is one of high frequencies, capable of being transmitted through the metal antenna and from it to detectors at moderate distances. Increased stressing or rubbing of contacts across contaminated (oxidized) metal surfaces results in enhanced microwave distress signals. These same signals can be used to create television images of metal surfaces, including geometric features such as scratches, or chemical features such as corrosion, oxides, contaminants such as fingerprints, or even the effects of adsorbed gas layers or amorphous coatings. With a low-voltage electron beam scanning such surfaces (as in a vidicon television camera tube), the surface features are not damaged, and their images can be reproduced faithfully over long periods of time. In this special case, conditions reflected by eddy current reactions as electrons transit metal surfaces can be imaged with remarkable clarity. Typical images enlarged 30X show detail approaching a few micrometers in dimensions.

## Appendix I

### Electromagnetic Induction Non-Destructive Tests

#### Principle of Operation:

Electromagnetic induction non-destructive tests are characterized by the induction of varying electrical currents in the test object by means of repeated variations in an electromagnetic field. This method contrasts with the electric current conduction tests in which current flows into the test object through direct electrical contacts from an external source. No input contacts are required with induction-type tests. The induced current in the test object produces

differences in electrical potential, magnetic fields, and heat or temperature gradients. When alternating or varying currents are induced in ferromagnetic materials, heat is produced not only by ohmic losses proportional to the square of the current density, but also by hysteresis losses in the magnetic material. The total "iron" losses, composed of both eddy current losses and hysteresis losses, are sometimes employed to indicate material properties. The pick-up may detect variations in electrical potential distribution, in magnetic field strengths, in high-frequency electromagnetic wave properties, in temperature, in mechanical force or torque, or in losses in the material of the test object, or combinations of these factors. A large number of patents cover tests of these types (Tables III and IV).

#### Potential Pick-up Methods:

Electromagnetic induction tests with potential contact pick-ups were proposed for testing of lead-sheathed cables and other tubular conductors by Atkinson (U.S. Patent Reissue 21,853) and Edgar (U.S. Patent 2,186,826). The method has not been too popular, however, because it is difficult to screen the pick-up circuit from the exciting electromagnetic field variations. Both Atkinson and Edgar proposed methods of introducing suitable neutralizing or compensating voltages in the pick-up circuit, 180 deg. out of phase with the disturbing emfs. Braddon (U.S. Patent 2,074,739) provided a method of locating the flaws in cable sheaths with a suitable indicator. Knerr (U.S. Patent 2,124,577) also included the use of potential pick-ups in his method for testing tubes and cylindrical objects.

#### Magnetic Field Distortion Pick-up Methods:

The detection of flaws by measurement of distortion in electromagnetic fields (which would have uniform intensity in the absence of flaws) has found wide use. Chappuzeau and Emersleben (U.S. Patent 1,782,462) employed a series of coils whose turns were parallel to the surface of test objects, such as tubes, bars, and rails, to detect deviations from normal magnetic field distributions. They further employed tuned output and input circuits to obtain optimum response to harmonic signals. Stein (U.S. Patent 1,992,100) proposed tube- and bar-testing apparatus which consists of main exciting coils which set up a normally neutral zone in the fields between them, and a test



coil located in the neutral zone, whose output actuates an indicator such as a cathode-ray tube.

Several arrangements of exciting and pick-up coils, including those in which the exciting coil is placed within the tube and the pick-up coils are placed outside the tube, were patented by David (U.S. Patent 2,065,118). He also employed electronic amplification of pick-up signals, with provision for permanent records or for marking the test object. In U.S. Patent 2,065,119, he points out that voltages induced by distortion of the magnetic fields are exceedingly minute, often as low as one-millionth of a volt. Also, a variation of 0.0001 in. in the position of the detector element from its true electrical center in the exciting field can produce comparable signals. Furthermore, as the article being tested moves through the exciting field, its motion tends to deflect the electrical center of the system in the direction of its travel. Precision adjustments of coil locations are essential to correct these difficulties.

A simple means for testing interior surfaces of tubes was proposed by Greenslade (U.S. Patent 2,104,646), and consisted of search coils connected in a Wheatstone bridge circuit.

Hay (U.S. Patent 2,150,922) produced longitudinal a-c. magnetization in cylindrical test objects which were then rotated past a fixed pick-up coil to reveal flaws. The depth of flaw penetration was estimated by varying the exciting frequency or by providing d-c. saturation of ferromagnetic materials, so as to vary the depth of penetration of eddy currents. A cathode-ray tube was used as an indicator.

In U.S. Patent 2,162,710, Gunn showed a small probe containing exciting coils and pick-up coils located so as to be sensitive only to distortions in eddy current flow in the test object. The pick-up signal was synchronously rectified so that it might actuate a sensitive d-c. galvanometer. An automobile tire nail detector patented by Wages (U.S. Patent 2,502,626) employed a vacuum tube amplifier and place circuit meter to detect magnetic field distortion.

A third harmonic in the pick-up signal was found responsive to flaws in test objects excited uniformly with a 60-cycle magnetic field, by Sams and Moriarty (U.S. Patent 2,007,772).

Michel (U.S. Patent 2,489,920) used vacuum tube phase discriminator circuits to actuate neon indicators and relays in a metal detector for use in manufacturing linoleum. Bovey (U.S. Patent 2,495,627) used a rectifier bridge to convert unbalanced field signals to a d-c. meter deflection in his metal-object sorter.

#### Transformer Pick-up Methods:

Several tests have been proposed in which test objects form the cores of transformer arrangements. The primary coils are excited with sinusoidal alternating currents, and the secondary induced voltage magnitudes and wave shapes are examined to detect flaws or material properties. Kinsley (U.S. Patent 1,813,746) proposed the use of a magnetic oscillograph to examine such wave shapes, as well as the use of relays operating on the difference between secondary signals obtained from standard and unknown test objects such as tubes and bars. Billstein (U.S. Patent 1,958,079) proposed a rail tester in which the secondary signal is amplified and its magnitude suitably indicated. In U.S. Patent 2,084,274, he claimed improved sensitivity as a result of shunting the exciting and pick-up coils with suitable capacitors. Hallowell (U.S. Patent 2,010,189) employed a cathode-ray oscillograph with the exciting signal applied to one set of deflection plates, and the differential output signal (between standard and unknown test objects) applied to the second set of deflection plates. Ebel (U.S. Patent 2,111,210) used concentric exciting and pick-up coils of pancake form, located in a plane parallel to the surface of the cable sheaths under test. A similar arrangement was patented by Loewenstein (U.S. Patent 2,116,119), the inner pancake coil diameter being designed to intercept a component of flux greatly dependent upon the thickness of the sheet or tube being tested.

To detect small flaws by eddy current flow in magnetic tubes and bars, Knerr (U.S. Patent 2,124,577) rendered the material substantially nonmagnetic by subjecting it to a high degree of magnetic saturation with a saturating d-c. coil or strong permanent magnet. A transformer-type exciting and pick-up circuit arrangement was used to compare standard and unknown test objects. In U.S. Patent 2,124,579, he indicates that pick-up coils should have small dimensions comparable to those of flaws to be detected, for optimum sensitivity. A plurality of such small



coils, disposed over the surface of the test object, may be required for complete coverage.

Zuschlag arrives at similar conclusions in U.S. Patents 2,353,211 and 2,398,488, in which he proposes the use of small pick-up coils near the surface of a rotating specimen, and suggests several arrangements of circuit and detector. Canfield (U.S. Patent 2,245,568) also proposes to detect flaws by detecting variations in eddy current flow, but he uses the quadrature component of pick-up flux as a sensitive measure of changes in eddy current resistance. This component gives an indication which is relatively insensitive to changes in permeability of the article being examined.

Irwin (U.S. Patent 2,290,330) developed equipment for the simultaneous independent measurement and recording of a magnitude related to the phase angle between excitation and pick-up waves, and a second magnitude characteristic of the pick-up a-c. signal. Variation of leakage flux, as through a shunt transformer path, is employed by Thorne (U.S. Patent 2,311,715) to detect flaws which influence the permeability of rails.

DeLanty (U.S. Patent 2,315,943) proposed to concentrate the flux in tubular test objects by introducing low-resistance inserts within the tube at the point of testing. These high-conductivity inserts have induced in them large eddy currents which oppose the entry of magnetic flux into the insert, and presumably concentrate the flux in the tube wall under test.

#### High-Frequency Electromagnetic Wave Pick-up Methods:

Recent developments in ultra-high frequency sources, wave guides, oscillators, and detectors, particularly in wartime radar developments, have contributed new techniques to non-destructive testing. Because of the normal time lag before issuance of patents, only a limited number of such tests have been revealed. Two typical examples are given below:

Larrick (U.S. Patent 2,489,092) proposed the use of a high-frequency source and open-ended wave guide against which the surface of the test object is placed. Surface resistance and the thickness of nonconducting coatings are evaluated in terms of the resonant frequency of the wave-guide system.

Schlesman (U.S. Patent 2,491,418) proposed that the standard and unknown test objects be placed successively within or across the opening of a high-frequency cavity resonator. Changes in conditions of cavity resonance would detect test objects differing from the standard.

#### Magnetic Loss Pick-up Methods:

Burrows (U.S. Patents 1,676,632 and 1,686,679) proposed the use of pick-up coils adjacent to tubes and bars excited by an alternating electromagnetic field. The pick-up coils were connected to the moving coils of a dynamometer relay or meter whose fixed coils were connected in series with the exciting current, to obtain a measure of hysteresis losses in the test specimen. The signal was obtained from series-opposed pick-up coils, one coil being used with a standard specimen, and the second coil being used with the unknown specimen. The "duroscope," invented by Sams and Shaw (U.S. Patent 1,789,196-Reissue 18,889), provided magnetizing and pick-up coils in a single probe, and used a similar wattmeter arrangement to measure the iron losses in the area of cutting tools under the probe.

DeForest (U.S. Patents 1,897,634 and 1,906,551) provided means for measuring magnetic losses in sheets and tubes under different testing conditions such that the indication was influenced first by the combined electrical and magnetic properties of the material, and second, by a change in, and characteristic of, but one of the unobserved properties--; for example, the magnetic one. These measurements were correlated with stresses in the material, in U.S. Patent 1,906,551.

Electromagnetic induction tests in which plates and tubes were excited by a high-frequency field coil connected to a vacuum tube oscillator were employed by Kranz (U.S. Patent 1,815,717) and by Mudge and Bieber (U.S. Patent 1,934,619). The reaction of the test object (presumably the magnetic losses) was detected by changes in the amplitude of the exciting oscillations in the vacuum tube circuit.

Eddy current losses in the test object were employed to detune a high-frequency oscillator, one of whose harmonics was heterodyned with a different harmonic of a standard frequency signal to provide beat signals, in a rod tester described by Dana (U.S. Patent 1,984,465). Roop (U.S. Patent 2,055,672) placed stan-

dard and test bars in opposite sides of an inductance-type bridge circuit, whose unbalanced output signal was amplified and applied to a thyatron relay which operated suitable markers to indicate the location of defects on the test object.

Zuschlag (U.S. Patent 2,077,161) reveals the difficulties of compensating loss testers for variations (other than flaws) in test objects and standards, and for electromagnetic interference from extraneous sources, and proposes circuit improvements to reduce their undesirable effects. In U.S. Patent 2,098,991, he proposes an artificial standard circuit which introduces into the pick-up circuit signals corresponding to the indications of a standard test object, with which the indications of an unknown test object are automatically compared during testing. Further improvements in the detection circuit are shown in U.S. Patents 2,208,145, 2,329,810, and 2,329,811.

Kinsley (U.S. Patent 2,101,780) designed exciting coil assemblies which produced uniform flux densities over the test area in sheets, bars, and strips, so that eddy current and hysteresis losses (of importance in sheet materials for transformers, dynamos, and other electrical equipment) might be measured in a manner comparable to standard Epstein tests of specially cut samples.

Fermier (U.S. Patent 2,389,190) devised equipment whereby tubes and bars could be subjected to a series of exciting frequencies, each producing a different penetration of eddy currents. The voltage drop across the exciting coil (in the tank circuit of a vacuum tube oscillator) was registered, for each frequency, by a point on the screen image of a cathode-ray oscilloscope, so that the response to several test frequencies could be observed simultaneously. The indications have been correlated with properties, such as carbon content of material in the surface layers.

#### Thermal Pick-up Methods:

DeForest (U.S. Patent 1,869,336) described several arrangements of coils for induction heating of tubes and welds, whose temperature distribution was indicated by isothermals delineated by melting of stearin or other suitable temperature indicators. Somes (U.S. Patent 2,340,150) proposed the use of high-frequency induction heating with heavy induced currents. As the induction-heated zone progressed

uniformly along the tube wall, the heavy currents, upon striking a high-resistance sand hole or pocket hidden from the surface by a layer of homogeneous metal, caused a burn-out resulting from fusion at the point, thus breaking down the wall of the tubular object and revealing the hidden defect.

#### Mechanical Pick-up Methods:

A novel method of detection was proposed by Burrows (U.S. Patent 1,599,645) in which a magnetizable test object was placed on a rotatable spindle in a three-phase rotating magnetic field. The torque developed in the object (which acted somewhat like the rotor of an induction motor) was measured by the displacement of the supporting spindle against a restraining spring, and was assumed to measure significant physical characteristics of the test object.

#### Technical Literature References on Electromagnetic Induction Non-Destructive Tests

- (1) Konig, "Nondestructive Testing of Railway Car Wheels and Axles for Surface Cracks," Oregon Fortschr. Eisenbahnw., Vol. 91, December 15, 1936, pp. 504-509.
- (2) L. H. Ford and E. E. Webb, "Nondestructive Testing of Welds," The Engineer, Vol. 165, April 8, 1938, pp. 400-401.
- (3) Anonymous, "Nondestructive Test (Production) for Steel Tubing," Steel, Vol. 107, October 21, 1940, pp. 38-40, 75.
- (4) Ross Gunn, "Eddy-Current Method for Flaw Detection in Nonmagnetic Metals," Journal of Applied Mechanics, Vol. 8, No. 1, March, 1941, pp. A22-26.
- (5) W. Jellinghaus and F. Stablein, "Nondestructive Testing to Detect Internal Seams in Sheets," Technische Mitteilungen Krupp, Ausgabe A. Forschungsber, Vol. 4, April, 1941, pp. 31-36.
- (6) A. Trost, "Testing Non-Ferrous Pipes, Bars and Shapes with Eddy Currents," Metallwirtschaft, Vol. 20, pp. 697-699 (1941); also Chemische Zentralbl, Vol. 1, p. 801 (1942).



- (7) W. A. Knopp, Jr., "Rapid Nondestructive Testing with Cathode Ray Oscilloscope," *Instruments*, Vol. 16, January, 1943, pp. 14-15.
- (8) F. Forster and H. Breitfeld, "Nondestructive Test by an Electrical Method," *Aluminium*, Vol. 25, March, 1943, p. 130.
- (9) James G. Clarke and Charles F. Spitzer, "Electronic Locator for Salvaging Trolley Rails," *Electronics*, Vol. 17, January, 1944, p. 129.
- (10) F. Forster and H. Breitfeld, "Nondestructive Testing of Light Metals Using A Testing Coil," *Light Metals Bulletin*, Vol. 7, April 28, 1944, pp. 442-443.
- (11) Anonymous, "Nondestructive Testing," *Automobile Engineering*, Vol. 34, May, 1944, p. 181.
- (12) J. Albin, "Salvaging and Process Control with the Cyclograph," *The Iron Age*, Vol. 155, May 17, 1945, pp. 62-64.
- (13) John H. Jupe, "Crack Detector for Production Testing," *Electronics*, Vol. 18, No. 10, October, 1945, pp. 114-115.
- (14) H. L. Edsall, "Magnetic Analysis Inspection of Metals," *Materials & Methods*, Vol. 22, December, 1945, pp. 1731-1735.
- (15) H. Mader, "Magneto-Inductive Testing," *Metal Industry*, Vol. 68, January 18, 1946, pp. 46-48.
- (16) P. E. Cavanagh, E. R. Mann, and R. T. Cavanagh, "Magnetic Testing of Metals," *Electronics*, Vol. 19, August, 1946, pp. 114-121.
- (17) Vin Zeluff, "Electronic Inspection," *Scientific American*, Vol. 174, No. 2, February, 1946, pp. 59-61.
- (18) J. E. Carside, "Metallic Materials Inspection," *Metal Treatment*, Vol. 13, Spring, 1946, pp. 3-18.
- (19) G. R. Polgreen and G. M. Tomlin, "Electrical Nondestructive Testing of Materials," *Electronic Engineering*, London, Vol. 18, No. 218, April, 1946, pp. 100-105.
- (20) R. L. Cavanagh, "Nondestructive Testing of Metal Parts," *Steel Processing*, Vol. 32, No. 7, July, 1946, pp. 436-440.
- (21) P. E. Cavanagh, "A Method for Predicting Failure of Metals," *ASTM Bulletin*, No. 143, December, 1946, p. 30.
- (22) R. L. Cavanagh, "Nondestructive Testing of Drill Pipe," *Oil Weekly*, Vol. 125, March 10, 1947, pp. 42-44.
- (23) Howard C. Roberts, "Trends in Electrical Gaging Methods," *Instruments*, Vol. 20, April, 1947, pp. 326-330.
- (24) C. H. Hastings, "Recording Magnetic Detector Locates Flaws in Ferrous Metals," *Product Engineering*, Vol. 18, April, 1947, pp. 110-112.
- (25) Anonymous, "Electronic Comparators," *Automobile Engineer*, Vol. 37, July, 1947, pp. 271-272.
- (26) P. E. Cavanagh, "Some Changes in Physical Properties of Steels and Wire Rope During Fatigue Failure," *Transactions, Canadian Inst. Mining and Metallurgy*, July, 1947, pp. 401-411.
- (27) G. B. Bowman, "Measurement of Thickness of Copper and Nickel Plate," *Monthly Review*, Vol. 34, October, 1947, pp. 1149-1151.
- (28) R. S. Segsworth, "Uses of the DuMont Cyclograph for Testing of Metals," *Electronic Methods of Inspection of Metals (Am. Soc. Metals)*, pp. 54-70 (1947).
- (29) Charles M. Lichy, "Determination of Seams in Steel by Magnetic Analysis," *Electronic Methods of Inspection of Metals (Am. Soc. Metals)*, pp. 97-106 (1947).
- (30) P. E. Cavanagh, "The Progress of Failure in Metals as Traced by Changes in Magnetic and Electrical Properties," *Proceedings, Am. Soc. Testing Mats.*, Vol. 47, p. 639 (1947).
- (31) P. E. Cavanagh and R. S. Segsworth, "Nondestructive Inspection of Mine Hoist Cable," *Transactions, Am. Soc. Metals*, Vol. 38, pp. 517-545, discussion, pp. 545-550 (1947).
- (32) Carlton H. Hastings, "A New Type of Magnetic Flaw Detector," *Proceedings*,



- Am. Soc. Testing Mats., Vol. 47, p. 651 (1947).
- (33) Abner Brenner and Eugenia Kellogg, "Magnetic Measurement of the Thickness of Composite Copper and Nickel Coatings on Steel," Journal of Research, Nat. Bureau of Standards, Vol. 40, No. 4, April, 1948, pp. 295-299.
- (34) A. M. Armour, "Eddy Current and Electrical Method of Crack Detection," Journal of Scientific Instruments and of Physics in Industry, Vol. 25, June, 1948, pp. 209-210.
- (35) Kurt Matthaes, "Magnetinduktive Stahlprüfung," (Magneto-Inductive Testing of Steel) Zeitschrift für Metallkunde, Vol. 39, September, 1948, pp. 257-272.
- (36) James Gee, "Testing and Inspection of Wire Ropes," Mine and Quarry Engineering, Vol. 14, December, 1948, p. 375.
- (37) I. R. Robinson, "Magnetic and Inductive Nondestructive Testing of Metals," Metal Treatment and Drop Forging, Vol. 16, Spring, 1949, pp. 12-24.
- (38) Abner Brenner and Eugenia Kellogg, "An Electric Gage for Measuring the Inside Diameter of Tubes," Journal of Research, Nat. Bureau of Standards, Vol. 42, No. 5, May, 1949, pp. 461-464. (RP 1986).
- (39) George A. Nelson, "The Probolog, for Inspecting Nonmagnetic Tubing," Metal Progress, Vol. 56, July, 1949, pp. 81-85.
- (40) P. Zijlstra, "An Apparatus for Detecting Superficial Cracks in Wires," Philips Technical Review, Vol. 11, July, 1949, pp. 12-15.
- (41) G. H. Vosskuhler, "Nondestructive Testing of the Al-Mg-Zn Alloy Hy-43 by a Magneto-Inductive Method," Metall, Vol. 3, August-September, 1949, pp. 247-251 and pp. 292-295.
- (42) P. Schneider, "Measuring the Wall Thickness of Light-Metal Cast Parts With Dr. Forster's 'Sondenkwimeter'," Metall, Vol. 3, October, 1949, pp. 321-324.
- (43) Theodore Zuschlag, "Magnetic Analysis Inspection in the Steel Industry," Symposium on Magnetic Testing, pp. 113-122, Am. Soc. Testing Mats., (1949). (Symposium issued as separate publication STP No. 85.)

SYMPOSIUM ON NON-DESTRUCTIVE TESTING

TABLE III.—PATENTS ON ELECTROMAGNETIC INDUCTION NON-DESTRUCTIVE TESTS.

Patent No.	Patent Date	Inventor	Assignee	Title	Number of Claims	Ex- pired
1,599,645	1/26/24	Charles W. Burrows	Burrows Magnetic Equipment Co.	Method of Testing Magnetizable Objects	6	Yes
1,676,632	7/10/28	Charles W. Burrows	Magnetic Analysis Corp.	Method of and Apparatus for Testing Magnetizable Objects	36	Yes
1,686,679	10/ 9/28	Charles W. Burrows	Magnetic Analysis Corp.	Apparatus for Testing Magnetizable Objects	..	Yes
1,782,462	11/25/30	Helmut Chappuzeau and Otto Emersleben	Neufeldt und Kuhnke Betriebsgesellschaft	Arrangement for Testing Magnetizable Objects	8	Yes
1,813,746	6/ 7/31	Carl Kinsley	Magnetic Analysis Corp.	Method of and Apparatus for Magnetic Testing	8	No
1,815,717	7/21/31	Hermann E. Kranz	Western Electric Co.	Apparatus for Measuring Variations in Thickness of Metallic Bodies	3	No
1,869,336	7/26/32	Alfred V. de Forest	....	Thermal Method of Testing Metallic Bodies	23	No
1,897,634	2/14/33	Alfred V. de Forest	American Chain Co.	Method of and Apparatus for Electromagnetic Testing	30	No
1,906,551	5/ 2/33	Alfred V. de Forest	....	Magnetic Testing Method and Means	12	No
Re. 18,889	7/ 4/33	J. A. Sams and Virgil F. Shaw	General Electric Co.	Apparatus for Testing Metals	10	No
1,943,619	1/16/34	Wm. A. Mudge and Clarence G. Bieber	....	Method and Apparatus for Testing Materials	2	No
1,958,079	5/ 8/34	Arthur E. F. Bilstein	The Pennsylvania Railroad Co.	Method and Apparatus for Testing for Internal Flaws	21	No
1,984,465	12/18/34	David W. Dana	General Electric Vapor Lamp Co.	Method of and Apparatus for Detecting Structural Defects in Materials	15	No
1,992,100	2/19/35	Wilhelm Stein	....	Testing Flaws and the Like in Working Materials	8	No
2,007,772	7/ 9/35	J. A. Sams and Charles D. Moriarty	General Electric Co.	Magnetic Testing Apparatus	6	No
2,010,189	8/ 6/35	Howard T. Hollowell, Jr.	Standard Pressed Steel Co.	Means for Testing Metal	2	No
2,055,672	9/29/36	Harold D. Roop	....	Metal Testing Device	7	No
2,065,118	12/22/36	Archibald H. Davis, Jr.	Steel and Tubes, Inc.	Method and Apparatus for Testing Metals for Defects	9	No
2,065,119	12/22/36	Archibald H. Davis, Jr.	Steel and Tubes, Inc	Flaw Detection	11	No
2,074,739	3/23/37	Fred D. Braddon	Sperry Products, Inc.	Indicating Device for Flaw Detector	5	No
2,077,161	4/13/37	Theo. Zuschlag	Magnetic Analysis Corp.	Magnetic Analysis Method	8	No
2,084,274	6/15/37	Arthur E. Bilstein	The Pennsylvania Railroad Co.	Electrical Tester	64	No
2,098,991	11/16/37	Theo. Zuschlag	Magnetic Analysis Co.	Magnetic Analysis	8	No
2,101,780	12/ 7/37	Carl K. Westfield	U. S. Steel Corp.	Electromagnetic Testing of Materials	18	No
2,104,646	1/ 4/38	Grover R. Greenslade	Pittsburgh Dry Stencil Co.	Means for Testing	3	No
2,111,210	3/15/38	Lawrence C. Ebel	Anaconda Wire and Cable Co.	Apparatus for Determining Wall Thickness	7	No
2,116,119	5/ 3/38	Alfred Loewenstein	....	System for Electrically Measuring the Thickness of Metallic Walls, Sheets, and the Like	13	No
2,124,577	7/26/38	Horace C. Knerr and Alfred R. Sharples	Steel and Tubes, Inc.	Method and Apparatus for Testing Metal Articles	9	No
2,150,922	3/21/39	Donald L. Hay	....	Apparatus and Method for Detecting Defects in Electrically Conductive Objects	9	No
2,162,710	6/20/39	Ross Gunn	....	Apparatus and Method for Detecting Defects in Metallic Objects	23	No
2,186,826	1/ 9/40	Robert F. Edgar	General Electric Co.	Eccentricity Indicator	4	No
2,208,145	7/16/40	Theo. Zuschlag	Magnetic Analysis Co.	Magnetic Analysis	18	No
Re. 21,853	7/15/41	Ralph W. Atkinson	General Cable Co.	Method and Apparatus for Measuring Eccentricity	36	No
2,245,568	7/17/41	Robert H. Canfield		Method of and Apparatus for Examining Ferromagnetic Articles	12	No

MCMaster AND WENK ON A BASIC GUIDE

TABLE III.—PATENTS ON ELECTROMAGNETIC INDUCTION NON-DESTRUCTIVE TESTS (Continued).

Patent No.	Patent Date	Inventor	Assignee	Title	Number of Claims	Expired
2,290,330	7/21/42	Emmett M. Irwin	Magnetest Corp.	Method of and Apparatus for Testing Properties of Materials	..	No
2,311,715	2/23/43	Harold C. Ghorne	....	Apparatus for and Method of Detecting Flaws in Rails and Other Objects	26	No
2,315,943	4/ 6/43	Loren J. DeLanty	Sperry Products, Inc.	Means for Testing Tubes	2	No
2,329,810	9/21/43	Theo. Zuschlag	Magnetic Analysis Corp.	Electromagnetic Inspection	19	No
2,329,811	9/21/43	Theo. Zuschlag	Magnetic Analysis Corp.	Electromagnetic Inspection	19	No
2,334,393	11/16/43	Lyle Dillon	Union Oil Co.	Determination of Magnetic and Electrical Anisotropy of Formation Core Samples	10	No
2,340,150	1/25/44	Howard E. Somes	Budd Induction Heating, Inc.	Fault-Testing Articles of Electrically Conductive Material	3	No
2,353,211	7/11/44	Theo. Zuschlag	Magnetic Analysis Corp.	Electrical Analysis	3	No
2,389,190	11/20/45	George F. Fermier	Reed Roller Bit Co.	Testing Means	4	No
2,398,488	4/16/46	Theo. Zuschlag	Magnetic Analysis Corp.	Magnetic Analysis	4	No
2,489,092	11/22/49	C. V. Larrick	General Electric Co.	High-Frequency Surface Testing Instrument	6	No
2,489,920	11/29/49	F. C. Michel	General Electric Co.	Metal Detector	5	No
2,490,554	10/15/46	Harcourt C. Drake	Sperry Products, Inc.	Flaw Detector for Tubing	4	No
2,491,418	12/13/49	C. H. Schlesman	Socony-Vacuum Oil Co., Inc.	Automatic Inspection Device	2	No
2,495,627	1/24/50	D. E. Bovey	General Electric Co.	Method for Sorting Metallic Articles	1	No
2,502,626	4/ 4/50	Morris L. Mages	Magnaflux Corp.	Electronic Metal Detector	4	No



TABLE IV.—OPERATIONAL FEATURES OF PATENTED ELECTROMAGNETIC INDUCTION NON-DESTRUCTIVE TESTS.

Patent No.	Type of Energy Source	Form of Energy Input	Form of Energy Output	Type of Pick-up	Type of Detector	Type of Indicator	Quantity Measured	Required Accessibility	Typical Application
1,599,645	a-c. generator or transformer	Electromagnetic induction	Magnetic field	Torque	Torque indicator	Torque indicator	Torque	Outside only	Magnetizable objects
1,676,632	a-c. generator or transformer	Electromagnetic induction	Magnetic field	Induced emf. coils	Dynamometer-type instrument	Dynamometer-type instrument	Hysteresis losses	Outside or one side only	Bar and tube tester
1,686,679	a-c. generator or transformer	Electromagnetic induction	Magnetic field	Induced emf. coils	Dynamometer-type instrument	Dynamometer-type instrument	Magnetic losses	Outside or one side only	Tube and bar tester
1,782,462	a-c. generator or transformer	Electromagnetic induction	Magnetic field	Induced emf. coils	Tuned circuit and amplifiers	Galvanometer-type instrument	Eddy current distortion	Outside or one side only	Tube, bar, rail, and sheath tester
1,813,746	a-c. generator or transformer	Electromagnetic induction	Magnetic field	Induced emf. coils	Galvanometer-type instrument	Galvanometer-type instrument	Electrical signals	Outside only	Tube and bar tester
1,815,717	Vacuum tube oscillator	Electromagnetic induction	Magnetic field	Induced emf. coils	Grid circuit of vacuum tube oscillator	Plate current of vacuum tube oscillator	Magnetic losses	One side	Cable sheath or tube tester
1,869,336	a-c. generator or transformer	Electromagnetic induction	Thermal	Thermal	Stearin	Stearin	Temperature	One or two sides	Tube or weld tester
1,897,634	a-c. generator or transformer	Electromagnetic induction	Magnetic field	Induced emf. coils	Bridge circuit	Variable resistance	Magnetic losses	One side only	Wire, bar, plate, sheet, and tube tester
1,906,551	a-c. generator or transformer	Electromagnetic induction	Magnetic field	Induced emf. coils	Dynamometer-type instrument	Dynamometer-type instrument	Permeability and core losses	Outside	Measuring stresses and forces of magnetic materials
Reg. 18,889	a-c. generator or transformer	Electromagnetic induction	Magnetic field	Induced emf. coils	Dynamometer-type instrument	Dynamometer-type instrument	Eddy current losses	One side	Cutting tool tester
1,943,619	Vacuum tube oscillator	Electromagnetic induction	Magnetic field	Induced emf. coils	Vacuum tube oscillator	High-frequency milliammeter	Magnetic losses	One side	Plate and tube tester
1,958,079	a-c. generator or transformer	Electromagnetic induction	Magnetic field	Induced emf. coils	Vacuum tube amplifier	Ammeter	Magnetic field distortion	Top side of rail	Rail tester
1,984,465	Vacuum tube oscillator	Electromagnetic induction	Magnetic field	Induced emf. coils	Wheatstone bridge circuit	Visual or auditory alarm	Eddy current distortion	Outside or one side only	Wire and rod tester
1,992,100	a-c. or d-c. generator	Electromagnetic induction	Magnetic field	Induced emf. coils	Wheatstone bridge circuit	Cathode-ray tube or other indicator	Magnetic field distortion	Outside or one side only	Tube, rod wire tester
2,007,772	a-c. generator or transformer	Electromagnetic induction	Magnetic field	Induced emf. coils	Vacuum tube amplifier	Visual or auditory alarm	Magnetic field distortion	Outside only	Strip, bar, or tube tester
2,010,189	a-c. generator or transformer	Electromagnetic induction	Magnetic field	Induced emf. coils	Vacuum tube amplifier	Cathode-ray oscilloscope	Magnetic permeability	Outside	Tube and bar tester
2,055,672	a-c. generator or transformer	Electromagnetic induction	Magnetic field	Induced emf. coils	Vacuum tube amplifier and thyatron hook-up	Paint spray or marker	Magnetic losses	Outside	Tube and bar tester
2,065,118	Vacuum tube oscillator	Electromagnetic induction	Magnetic field	Two induced emf. coils	Vacuum tube amplifier and rectifier	Visual or auditory alarm	Magnetic field distortion	Inside and outside only	Tube tester
2,065,119	Vacuum tube oscillator	Electromagnetic induction	Magnetic field	Induced emf. coils	Vacuum tube amplifier and rectifier	Visual or auditory alarm	Magnetic field distortion	Outside	Plate, tube, and bar tester
2,074,739	a-c. generator or transformer	Electromagnetic induction	Magnetic field	Potential contacts	Vacuum tube amplifier	Recorder and visual indicator	Eddy current distortion	Outside	Cable sheath tester
2,077,161	a-c. generator or transformer	Electromagnetic induction	Magnetic field	Two induced emf. coils	Wheatstone bridge circuit	Voltmeter or potentiometers	Electrical signals	One side	Magnetic material tester
2,084,274	a-c. generator or transformer	Electromagnetic induction	Magnetic field	Two induced emf. coils	Vacuum tube amplifier	Ammeter	Eddy current distortion	One side	Rail tester
2,098,991	a-c. generator	Electromagnetic induction	Magnetic field	Induced emf. coils	Vacuum tube amplifier	Galvanometer-type instrument	Eddy current losses	Outside	Tube and bar tester

2, 101, 780	a-c. generator or transformer	Electromagnetic induction	Magnetic field	Induced emf. coils	Dynamometer-type instrument Wheatstone bridge circuit	Dynamometer-type instrument Ammeter	Magnetic losses	Two sides or one side only	Sheet, tube, and bar tester Locomotive axle tester
2, 104, 646	a-c. generator or transformer with or without rectifier	Electromagnetic induction	Magnetic field	Induced emf. coils	Voltmeter	Voltmeter	Eddy current magnetude	One side only	Cable sheath tester
2, 111, 210	a-c. generator or transformer	Electromagnetic induction	Magnetic field	Induced emf. coils	Ammeter	Ammeter	Magnetic permeability	One side	Metal sheet tester
2, 116, 119	a-c. generator or transformer	Electromagnetic induction	Magnetic field	Induced emf. coils	Vacuum tube amplifier	Pen on chart	Magnetic permeability	One side only	Conical and cylindrical objects primarily
2, 124, 577	a-c.-d-c. generator	Electromagnetic induction	Magnetic field	Opposed induced emf. coils	Vacuum tube amplifier	Cathode-ray oscilloscope or voltmeter	Eddy current distortion	One side only	Tube and bar tester
2, 124, 579	a-c. or pulsating d-c.	Electromagnetic induction	Magnetic field	Induced emf. coils	Cathode-ray oscilloscope or voltmeter		Eddy current distortion	Outside	Tube and bar tester
2, 150, 922	a-c. generator or transformer	Electromagnetic induction	Magnetic field	Induced emf. coils	Galvanometer and mechanical rectifier	Galvanometer-type instrument	Eddy current distortion	One side only	Metal objects tester
2, 162, 710	Low-frequency a-c. generator	Electromagnetic induction	Magnetic field	Two coils responsive to asymmetrical distribution of electromagnetic field	Galvanometer and mechanical rectifier				
2, 186, 826	a-c. generator or transformer	Electromagnetic induction	Potential drop	Four potential contacts	Vacuum tube amplifier	Strip chart recorder	Eddy current distortion	Outside	Lead sheath tester
2, 208, 145	a-c. generator or transformer	Electromagnetic induction	Magnetic field	Induced emf. coils	a-c. mixer and rectifier	Galvanometer-type instrument	Electrical signals	Outside or one side only	Tube and bars tester
Re. 21,853	a-c. generator or transformer	Electromagnetic induction	Magnetic field	Potential contacts	Galvanometer-type instrument or strip chart recorder	Galvanometer-type instrument or strip chart recorder	Eddy current distortion	Outside only	Thickness tester
2, 245, 568	a-c. generator or transformer	Electromagnetic induction	Magnetic field	Induced emf. coils	Quadrature flux emf. discriminator	Voltmeter	Eddy current losses	One side only	Examine ferromagnetic articles
2, 290, 330	a-c. generator or transformer	Electromagnetic induction	Magnetic field	Induced emf. coils	Vacuum tube amplifier	Strip chart recorder	Phase angles between voltage and current	Outside	Tube and bar tester
2, 311, 715	Transformer	Electromagnetic induction	Magnetic field	Induced emf. coils			Magnetic permeability	One side only	Rail tester
2, 315, 943	a-c. generator or transformer	Electromagnetic induction	Magnetic field	Induced emf. coils			Eddy current losses	Inside and outside	Tube tester
2, 329, 810	Vacuum tube oscillator	Electromagnetic induction	Magnetic field	Induced emf. coils	Vacuum tube amplifier	Galvanometer-type instrument	Eddy current losses	Outside only	Bar and tube tester
2, 329, 811	Vacuum tube oscillator	Electromagnetic induction	Magnetic field	Induced emf. coils	Vacuum tube amplifier	Cathode-ray oscilloscope	Eddy current losses	Outside	Tube and bar tester
2, 334, 393	Vacuum tube oscillator	Electromagnetic induction	Magnetic field	Induced emf. coils	Heterodyne circuit	Frequency meter	Magnetic permeability	Outside only	Core sample tester
2, 340, 150	Induction heating generator	Electromagnetic induction	Thermal	Visual	Visual	Visual or auditory alarm	Temperature	Inside only	Tube tester
2, 353, 211	a-c. generator or transformer	Electromagnetic induction	Magnetic field	Induced emf. coils	Balancing system	Galvanometer-type instrument	Eddy current distortion	One side	Tube and bar tester
2, 389, 190	Vacuum tube oscillator	Electromagnetic induction	Magnetic field	Induced emf. coils	Cathode ray	Cathode-ray oscilloscope	Eddy current losses	One side	Test for carbon content of tubes and bars
2, 398, 488	a-c. generator or transformer	Electromagnetic induction	Magnetic field	Induced emf. coils	Wheatstone bridge and amplifier	Voltmeter	Magnetic losses	Outside or one side	Tube and bar tester



TABLE IV.—OPERATIONAL FEATURES OF PATENTED ELECTROMAGNETIC INDUCTION NON-DESTRUCTIVE TESTS (Continued).

Patent No.	Type of Energy Source	Form of Energy Input	Form of Energy Output	Type of Pick-up	Type of Detector	Type of Indicator	Quantity Measured	Required Accessibility	Typical Application
2,489,092	Ultra high frequency oscillator	High frequency electromagnetic waves	High frequency voltage or current	Wave guide pick-up loop	Crystal rectifier	High resistance d-c. galvanometer	Wave guide resonance	One side only	Nonconducting coating thickness test
2,489,920	Electronic oscillator (150-5000)	Electromagnetic induction	a-c. magnetic field	Opposed emf. coils	Vacuum tube phase discriminator	Neon lamps, relays	Magnetic field distortion	Outside or one side only	Linoleum manufacturing metal detector
2,490,554	a-c. generator or transformer	Electromagnetic induction	Magnetic field	Induced emf. coils	Vacuum tube amplifier	Voltmeter	Magnetic field distortion	Outside or one side	Tube tester
2,491,418	High frequency electronic oscillator	Cavity resonator high frequency field	High frequency a-c. emf.	High frequency probe loop	Electronic amplifier detector	Strip chart recorder	Cavity resonance	Outside only	Sorting, geometry
2,495,627	Multiple-frequency audio oscillator	Electromagnetic induction	Magnetic field	Induced emf. coils	Rectified Wheatstone bridge	d-c. meter	Magnetic field distortion	Outside only	Metal object comparator
2,502,626	Electronic oscillator	Electromagnetic induction	Magnetic field	Opposed induced emf. coils	Vacuum tube amplifier	Plate circuit milliammeter	Magnetic field distortion	Outside or one side only	Automobile tire nail detector

EDDY CURRENT TESTING: PRESENT AND FUTURE APPLICATIONS  
IN THE FERROUS METALS INDUSTRY

Richard Moyer

Carpenter Technology Corporation  
Reading, PA 19603

The scope of these remarks is to present the past, present, and future applications of eddy current testing in the ferrous metals industry, or more specifically, in the basic steel producing industry. The source of the data for the review of the past is a survey conducted about ten years ago by the American Iron and Steel Institute. The current and future information originates from discussions and correspondence with members of the AISI Technical Committee on Non-destructive Testing and Inspection Systems.

I am grateful for the opportunity to review for this particular audience where we have been, where we are, and where we would like to go. It is apparent that the participants of this workshop and the National Bureau of Standards will have a strong impact on these future directions. It is forums like these that will pilot advancements into useful and practical channels to the benefit of us all, the steel industry included.

Almost twelve years ago, the newly formed Institute committee surveyed the steel industry NDT practices through a series of questionnaires. The companies reporting provided information on a total of 313 NDT inspection systems. These involved four product types: bar, plate, semi-finished, and tubular products. The distribution of these among the major NDT disciplines is shown in the first table.

An assessment of equipment reliability was reported in the survey. Respondents were asked to judge the reliability of a system as excellent, good, fair, or poor. To these, numerical values 4 through 1, respectively, were assigned. The resulting average ratings for the various types and methods are shown in the second table.

The prominent feature of these data is that eddy current testing had appeared to reach a maturity as long as ten years ago from both an application and a reliability standpoint. It certainly was one of the big five of NDT.

Table 1. Number of Systems

Product Form	Eddy Current	Liquid Penetrant	Magnetic Particle	Radio-logical	Ultra-sonic
Bar	31		16		17
Plate			5		18
Semi-Finished			17		38
Tubular	48	17	26	22	58

Table 2. System Reliability

Product Form	Eddy Current	Liquid Penetrant	Magnetic Particle	Radio-logical	Ultra-sonic
Bar	3.2		3.0		3.4
Plate					3.4
Semi-Finished					3.1
Tubular	3.2	2.4	3.1	3.1	3.2



But what about today? Has eddy current testing extended any horizons? Has it fulfilled any new application needs? Is it more sensitive? More accurate? More reliable? Do the developments of the last ten years signify a truly expanding technology?

It is unfortunate that a similar statistical survey reflecting today's usages is not available to give quantitative answers to these questions. A survey is not needed to fill in one of the blank spaces of Table 1. Eddy current inspection of semi-finished billets, both round and square, has become an accepted technique, routine in some mills.

The topic of semi-finished product testing leads directly to an expanding related area of application; in process testing. This is simultaneous ECT while another phase of the manufacturing cycle is being performed. Utilization of the technique has been made in conjunction with bar straighteners, wire drawing blocks, and more recently, hot rolling mills for both tubular and solid products.

In addition to inspecting its own products, the steel industry has found ECT useful in defect detection in items of its processing equipment. Rolling mill rolls and crane hooks are notable examples.

The steel industry has found eddy current testing techniques applicable for uses other than flaw detection. The more prominent of these are coating thickness measurement and sorting. The thickness and uniformity of copper plating on cold heading coil stock is reliably determined by this technique. Sorting for separation of grade, hardness, size, or other feature by eddy currents is a field equally as large and as important as flaw detection.

The problems associated with today's ECT applications in the steel industry can be grouped into two categories: operational and performance. "Operational" is concerned with the ease or convenience of employing the method, while "performance" concerns the sensitivity, accuracy, reliability, and/or effectiveness of the test.

One of the principal operational difficulties is the loss of productive time during set-up and calibration for stock size change. This problem exists for both encircling coil and rotating probe machines--obviously the more complex

the apparatus, the longer the downtime. This is not as serious a disadvantage for in-process testers as for separate test stations, for presumably, adjustments to the tester could be made while the processor is changed.

Convenience of calibration is another operational problem. This may be more difficult on an in-process tester than on a test station, especially if a reference calibration piece with real or artificial defects is involved.

Another operational difficulty is maintaining the proper transducer (coil) to product spacing and alignment despite the influence of temperature extremes, mechanical handling system irregularities, crooked ends, etc. The latter could be so severe as to cause damage or excessive wear, thus shortening the preventative maintenance cycle. Ease of maintenance is, of course, another operational consideration.

In considering performance problems, reliability must be listed prominently. Is it a certainty that, when set to detect .008 inch seams, an eddy current tester will not accept a bar with one .012 inch deep? Or, will a bar with a harmless scratch of .004 inch be rejected? Also, in sorting mixed steel, is the separation absolutely correct? The steel industry is not sure.

Another performance problem is accuracy of calibration. There are many types of artificial defects used for calibration or set-up purposes. The true correspondence of the eddy current responses to them and to natural defects is either unknown or something vastly different from one to one. This lack of correlation is also influenced by the way the artificial defect was made--electric discharge machining, mechanical metal removal, manual filing, etc. The shape of the calibration defect is not always representative of the true defect it measures, as with a hole drilled through the wall of a tube.

Another performance deficiency is the inability of encircling differential coil systems to reliably detect and accurately evaluate continuous defects. This need is severely felt on installations where rotating probes are unsuitable, such as on a hot rolling mill.

Test sensitivity and its relation to inherent noise creates a performance problem. Often a realistic accept/reject level cannot be achieved with eddy current test equipment because that level is submerged in background noise. Unfortunately, phase adjustments do not always provide a differentiation to solve the problem.

A performance feature not yet adequately addressed by equipment designers is the lack of clear relation between the instrument's readout and the true nature, size, orientation, and location of the anomaly disclosed.

A performance consideration needing attention concerns the inspection of shapes other than rounds. There is a need to inspect the corners of square billets as critically as the faces. Conversely, there is an equal need to inspect the faces of hexagonal bars to the same degree as the corners.

Obviously each of the problem areas described earlier suggests a future need. Accordingly, only those having a pressing urgency will be repeated in this section devoted to future directions. The greatest need is a reliable eddy current instrument that will reliably detect and accurately evaluate continuous, as well as intermittent defects, in hot rolling mill product which is at 2000 °F as it leaves the mill.

Farther, toward the horizon, I visualize the utilization of the miracles of microelectronics in signal processing and pattern recognition to lead us out of the realm of unreliability and lack of sensitivity. Other solutions to these problems might be found in pulse techniques or more sophisticated phase modulation and/or frequency analysis. Perhaps computer techniques will provide a hard copy printout of an eddy current test of a billet showing exactly where each flaw is located and how severe it is. Or, perhaps instead of the print-out, the computer will provide guidance to the grinder so that it may remove each flaw.

In summary, to answer the questions posed earlier, the science of eddy current testing has made progress in the last ten years, but there is a much longer road ahead.

## Discussion

Question (Mr. Weismantel, General Electric Co.): I have two questions, both of them involve opinion more than anything else. Number one, as you know, we looked at quite a few different mills with respect to the NDT capability. One of the things we noticed, especially in the eddy current area more than the ultrasonic area, was the lack of standardization between mills within the same industry as far as how the process was applied and how it was controlled. That is one of the reasons that we, as a purchaser, come out with specifications which you might think are overly demanding or are different than someone else would expect. Who do you feel should try to get standardization within the steel industry for a product of this sort?

Answer (Mr. Moyer): I would answer that by saying that the customer pushes the producer into standardization. I say that because the status of standardization in ultrasonics, for example, is much further advanced; in other words, the steel industry performs inspections to customers' specifications at least 100 times more often in ultrasonics than we do in eddy current. That is because of customer insistence. I must confess that this push for standardization has been at the customer's impetus. Although eddy current testing in our mills predates ultrasonics, personnel qualification, standardization, and purchasing specifications to quantitative levels in eddy currents are lagging behind ultrasonics. Perhaps, we take the course of least resistance; if our customer says, you have got to do it this way or we will not buy from you, we tend to do it. In-house, we prefer to use eddy currents because of its economic aspects. We need not be quite as rigorous with standardization if we are satisfying ourselves, compared to what we would be if we were satisfying the customer.

Comment (Mr. Weismantel): It would appear that there is no attempt to establish a stable process between different mills. If we had found more standardization between the different producers, we would have more guidance as to how we establish our specifications.

Comment (Mr. Moyer): It goes a little deeper than that. There is a question in



my mind, perhaps it does not exist in Dr. McMaster's, but I am not sure what eddy currents are really sensitive to. I am not even sure whether they respond to the absence of metal or whether they respond to the work hardening around an artificial notch. Ultrasonics is a little different. Maybe I am gilding the lily a bit, but at least ultrasonics response has a stronger sensitivity to the reflecting area of a calibration notch providing it is properly oriented. We have a greater confidence in quantitative ultrasonic results than we do in eddy current results.

Comment (Mr. Booth, Bethlehem Steel Corp.): I would like to respond to that. I think customers bring part of the trouble on themselves in that they buy from several mills in irregular sequence at the lowest price. Whatever is coming down the production line, you may have steel from different mills and several companies going to production at such a rate there is no way of correlating results of tests. And, of course, AISI does not put any specifications on the magnetic properties of materials at all. Consequently, unlike Forster, who initially encouraged his customers to buy an entire melt or enough steel for a year or two's products and calibrate the hell out of it, with this random material coming down the line there is no possibility of realistic testing. So a part of the problem is the customer's fault; he does not demand a whole lot.

Comment (Mr. Weismantel): I have a second comment. You brought up the problem of how eddy current response relates to an EDM notch versus a response from a flaw of any particular nature. I look at the calibration of an instrument as a control to attain uniform inspection sensitivity. It is our responsibility as a purchaser to try to determine what that response level or rejection level should be, relative to the types of flaws we think are most damaging to us.

Comment (Mr. Moyer): I am delighted you are assuming that responsibility.

Comment (Mr. Weismantel): The point I am trying to make is we do like to see standardization in the calibration of the equipment. If there is one area the steel industry has a lot of standardization in, it is in their magnetic analysis equipment. That is one thing I have found true across the field; but beyond that, standardization stops.

Question (Mr. Berger): You indicated one of the big new uses for eddy current testing was in sorting materials, yet one of the problem areas you mentioned was the difficulty in sorting materials. Could you expand upon that? Are the things you measure too close in electrical properties for you to make an adequate separation?

Answer (Mr. Moyer): Sometimes, that is unfortunately true.

Question (Mr. Berger): Could you give us an idea of what level of repeatability or accuracy or sensitivity you are looking to achieve the sorting specifications you need?

Answer (Mr. Moyer): Well, my particular company makes a variety of steels, it numbers in the hundreds of grades, and some of those defeat any comparator when you try to separate them; for example, type 316 stainless and 316 low carbon stainless. There are some disastrous mixes for the automotive industry, for example, and I feel it is essential that the mix be separated with absolute certainty.

Comment (Mr. Hentschel): There is no reason to have disastrous mixes any more. We manufacture a microprocessor control that will sort through frequencies and so forth on the signature of those steels. The question comes down to the grosser differences and not the disastrous ones.

Comment (Mr. Moyer): This is why I am delighted this forum is assembled. These things are being brought to light.

Comment (Mr. Bugden): I think the point Bob McMaster made is pertinent to this, as far as all the variations, not only in chemistry but in processing of various steels. Certainly since we are talking about calibration, I think we can see how difficult it is. I would say that it is possible to sort mixes, but it is difficult in stainless steel or alloys to calibrate samples, and carry them over.

Comment (Mr. Hentschel): I want to add to the point that Dr. McMaster made. In Europe, they did respond in the manufacturing processes; they would be willing to change the process to allow an optimum set-up and rearrange the manufacturing to facilitate testing. When you try to suggest it here, they think you are crazy.

Comment (Mr. Moyer): Sometimes the suggestions that are made are very expensive. For example, a customer suggested that testing occur at a given intermediate size; that means we would have to interrupt a hot rolling cycle to get it at that size, provide a surface sufficient to accept the test, test it, and then re-introduce it to the hot mill.

Comment (Mr. Hentschel): In the automotive industry, there are examples where specs for the part manufactured do take testing into account. It is beginning to get better.

Question (Dr. Taylor): The Japanese are supposedly rather advanced in automatic steel production, at least that is what we read in the paper. Have they generally used eddy current testing in their steel mills?

Answer (Mr. Moyer): I cannot answer, I am sorry. I am not familiar with their techniques.

Question (Mr. Weismantel): With regard to the accuracy of calibration, you mention the lack of correlation between artificial defects and real defects. This is quite understandable. But how well does one do when comparing the response from two or more artificial defects, presumably made identically. Are these reproducible?

Answer (Mr. Moyer): We have not found them to be as reproducible as we would like. Unfortunately, the most recent reproducible artificial defect that we have found has been a hole completely through the wall of a tube, which psychologically is very unacceptable to a customer. But a lot of it has to do with what we said earlier, what are eddy currents sensitive to? It depends on how you manufacture the defect and how you standardize those processes, really, to make artificial defects reproducible.





## EDDY CURRENT STANDARDS IN NONFERROUS METALS

Carlton E. Burley  
Reynolds Metals Company  
Richmond, VA 23261

This presentation is not intended to represent the aluminum industry or any specific company, but to give some personal thoughts based on 20 years of experience in NDT activities.

When I first started my involvement in NDT, being trained in physics and electronics, one thing that puzzled me was the emphasis on ultrasonics and radiography and the exclusion of eddy currents for defect identification. Soon I learned that it is difficult to convince metallurgists and quality controllers that an eddy current "trace" has meaning.

In many cases, eddy current defect inspection has been oversold. It is not difficult to find surface cracks and surface scratches, but too often such imperfections mask the more serious problems of internal discontinuities and lead to excessive rejection rates. To avoid this, the sensitivity is reduced and everything passes inspection.

Eddy current inspection for material defects, in my opinion, requires techniques and operator competences that are usually not available in the typical plant.

Most of the processes that we use today have developed from laboratory and research investigations. This is, again, one of the characteristics of eddy current technology: the people who best understand electromagnetics and the behavior of materials are in the research laboratories. With such expertise, we are able to do much more with eddy currents in the laboratory than can be practically translated to our plants.

Most of the applications of eddy currents that are used are those involving the measurement of electrical conductivity. These tests are usually performed manually.

Let us examine how we use electrical conductivity and how standards are related to this parameter. We use quantitative, as well as qualitative, measurements of conductivity.

Figure 1 shows the range of electrical conductivity for some cast aluminum alloys. In all cases, the conductivity extends over a considerable range. The as-cast condition is shown as AC, annealed material as 0-temper and, in some cases, intermediate tempers are given. Notice that there is usually an overlap among alloys.

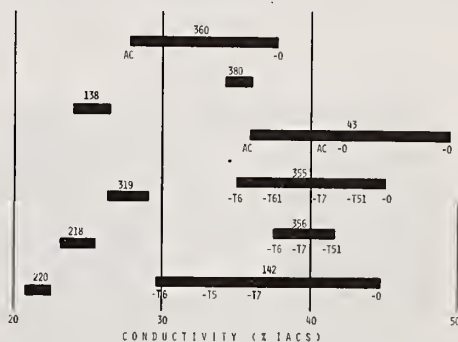

Figure 1. Conductivity of several aluminum casting alloys.

A similar situation is shown in figure 2. These are conductivity ranges for several wrought aluminum alloys.

This is one factor to be considered in standards for sorting; we can use eddy currents for sorting only if we know something more than the conductivity.

A further limitation is necessary for the heat treatable alloys. Figure 3 gives conductivity versus strength values which are typical of a 7XXX or 2XXX alloy. Notice that we have a cycle. We can start with the quenched material, proceed to naturally aged, then to artificially aged



and overaged and come back to an annealed condition.

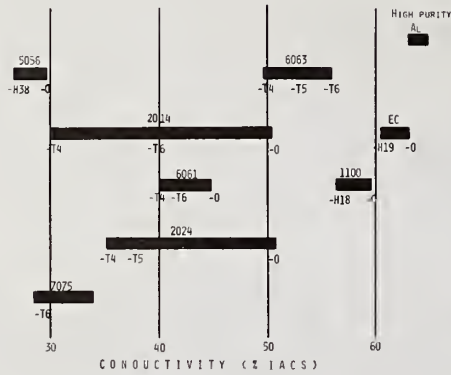

Figure 2. Conductivity of several wrought aluminum alloys.

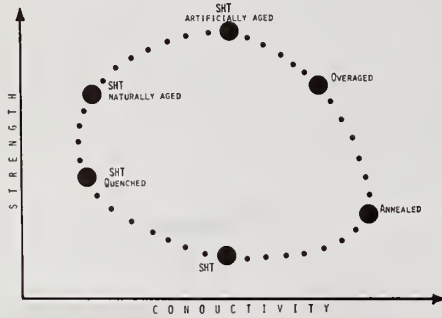

Figure 3. Conductivity versus strength cycle of heat treatable aluminum alloys.

There are many double points here. For example, if the conductivity is about midway or somewhat less than the peak at the artificial aging position, on which side of the peak are you? Are you heading for the overaged condition or are you on the natural aging side? This is important if the conductivity is to be a criterion for corrosion properties.

Thus, strength or some other mechanical properties are also required in order to apply eddy currents to identify temper for heat treatable materials.

These measurements, however, are a good example of an area in which conductivity standards have application. To measure electrical conductivity, you need a

resistance or conductivity standard. The standards generally used are aluminum bars or rods measured with a Kelvin bridge. Originally, when we set up our electrical standards lab, we furnished NBS with several samples for measurement and have subsequently used them as standards. These standards have been checked periodically by NBS or another qualified laboratory. Such calibration has been a direct current measurement. Thus, when we meet a customer's specification for percent IACS, we are certifying it against a DC standard since we calibrate our eddy current instruments to such DC standards<sup>1</sup>.

Our lab and plant standards are cut from Kelvin bridge measured specimens; these are used to certify working standards which are placed on each test instrument.

In many cases, we are not concerned with the absolute conductivity. In sorting, for example, only a conductivity difference may be needed. But if you need to measure a sample precisely, a question is: how accurately can you measure on an eddy current instrument?

It has been our experience that an eddy current technique is accurate to 1-2 percent of the reading. If a customer requires more precise conductivity certification (such as often required for an electrical conductor alloy), we would use a Kelvin bridge or equivalent DC measurement.

Errors can also creep into a calibrated eddy current conductivity meter. For example, assume you are using standards of 35 percent IACS and 50 percent IACS for a two-point calibration. If then you want to measure material having conductivity of about 25 percent, it is easy to have an unknown error since you have not verified the instrument linearity below 35 percent. In conductivity measurements, one calibration standard should be below the lowest value you wish to read and the second should have higher conductivity than any specimen you wish to read. For best accuracy, we recommend using two standards which are relatively close together; e.g., 30 and 40 percent should be used if you are measuring material in the range of 33-36 percent conductivity. The closer the standards bracket the sample, the greater is the accuracy obtainable.

<sup>1</sup>ASTM B193

NBS should continue to provide primary reference measurements for DC conductivity and resistivity. As an expansion, a facility to provide comparison measurements at 60 kHz and 100 kHz (common frequencies used for eddy current conductivity meters) would be a valuable aid to the NDT community.

Another measurement that is related to conductivity is the cladding thickness measurement, for example, of alclad alloys. Normally, specimens are cut from the corners of plate and sheet and measured optically to provide verification of cladding thickness. This is a slow process for large amounts of material and also does not provide a way to monitor or measure cladding thickness over an entire plate.

Eddy current phase relationships can be used to measure cladding thickness on aluminum alloys. Special probes had to be developed<sup>2</sup>. We found that with frequencies of 50 to 500 kHz we can accurately determine cladding thickness by an eddy current conductivity measurement.

Figure 4 shows a calibration curve for alclad 2024-T3. We are using a 200 kHz frequency; notice that we can spread out a five to ten mil cladding thickness over the entire range of the meter. This is a zero to 50 division meter.

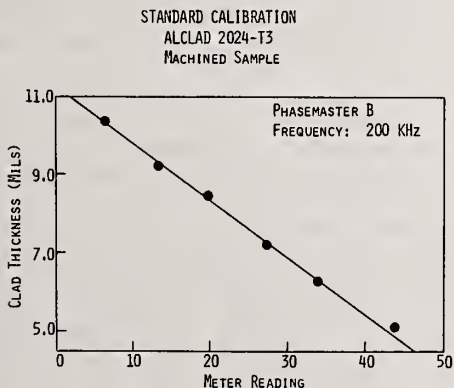

Figure 4. Calibration curve for alclad 2024-T3.

This range could be further extended. One feature about an instrument of this type is that you can, by zero suppression and range changing, develop a very sensi-

tive test; a cladding variation of 0.0001 inch can readily be measured.

As an example, figure 5 shows that by using a higher frequency, full-scale calibration has been reduced to three mils. The calibration is very close to being truly linear.

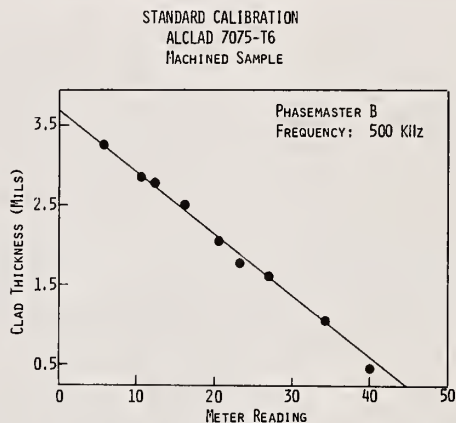

Figure 5. Calibration curve for alclad 7075-T6.

Where do you obtain standards for this type of measurement? Figure 6 shows alclad aluminum which has been machined to provide a calibrated step block.

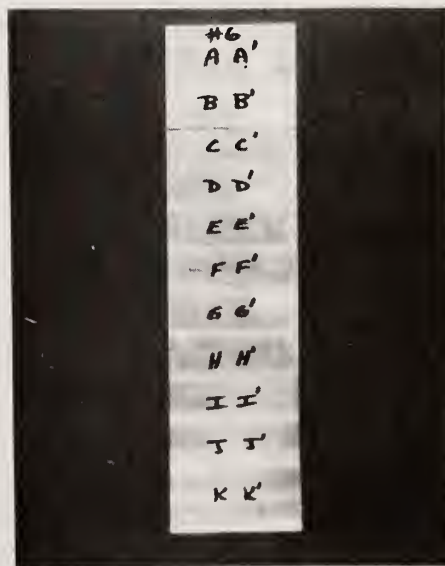

Figure 6. Machined step block for cladding thickness standard.

<sup>2</sup>Dr. C. Dodd of ORNL provided valuable guidance and assistance.



First, it is necessary to have a representative section. Initially, the material was scanned to be sure that the cladding was uniform. Then metallographic sectioning was used to check the inner-metallic layer for the presence of diffusion or any other metallurgical effects that could invalidate the conductivity measurement.

Once assured of a representative sample, a series of steps of roughly one mil each were machined from the cladding side. Then, a narrow slice of material was cut out of the center of the machined sample and the cladding thickness measured metallographically at each step. The edge pieces provided two standard step blocks from each machined specimen.

The above is an example of developing an in-house standard for a specific application. The development of universal standards for all clad products would be a major undertaking and one that we have not recommended. A procedure for developing such standards would probably be the most useful activity for NBS.

The above techniques have also been used to sort clad and unclad material such as sheet, plate, and tubing.

Lift-off techniques are used in the evaluation of products coated with non-conductive films. For these measurements, standards have been produced in-house (or by the equipment supplier) using optical thickness or film weight measurements. In the range of very thin base materials, such as coated aluminum foil, the lift-off method gives erratic readings. The measurement problems are compounded by the need to use very high frequencies to avoid measuring thickness variations of the foil.

Thickness measurements of aluminum foil can be readily accomplished with eddy currents. For example, 0.0005 inch foil is laminated to 0.0035 inch paper stock. Variations in the thickness of the foil can be a cause for rejection of this product. If there is a uniform or gradual change in thickness of the foil, the product is acceptable. But if there are periodic thickness variations of the order of 15 micro-inches or greater, the material can be rejected.

We have found that a 500 kHz eddy current test using a probe with a small diameter flat coil can readily measure these

thickness changes. Some of the foil/paper laminates were brought to the NBS Dimensional Technology Section where the thickness variations were confirmed with a laser interferometer. We are confident that our system can measure foil thickness variations to one microinch. The several samples that were measured at NBS are used in our laboratory and our plants for internal standards.

The above discussion has primarily been based on measurements related to conductivity changes in aluminum and aluminum alloys. The eddy current instrumentation is either amplitude or phase sensitive using a single or double probe configuration. Standards are, basically, specimens having known conductivities and/or known thicknesses.

The next area to be discussed is use of eddy current techniques to locate and define surface and internal discontinuities. Standards required and used in this area raise somewhat different problems than previously discussed.

One area for using eddy currents is location of edge laminations in plate. As aluminum is rolled to plate gauges from the original ingot thickness, edge laminations or roll-over can develop; even though edge trimming occurs, an edge crack may be present in the final product. While ultrasonic techniques are frequently used, these require the plates to be removed from stacks and individually measured. Using a small flat eddy current probe, cut edges of stacked plates can be readily scanned for cracks. Standards are required to set test sensitivity levels; plates with known laminations are used.

Another application that should be more widely used is inspection of tubing and pipe. While an ASTM procedure for this method has been published, we find that the use of notches and drilled holes is often inadequate for the specific examinations required. More frequently, standards used are materials with typical production defects--inadequate welds, ID and OD voids, etc.

At present, there is not a large amount of eddy current defect inspection done in the primary aluminum industry. One reason it is not used is the unfortunate oversell of equipment which, upon full evaluation, proves to be not designed or able to meet requirements. If it works with steel or copper, it will not necessarily work with aluminum.

An area in which I would like to see increased effort is measurement of materials at high temperatures. Continuous casting processes for both sheet and rod are becoming common; we are going to need better techniques for monitoring such products. Eddy current techniques have so much potential, at least theoretically, that improved detection procedures and data processing methods should have a good change of commercial success.

Part of the problem is that we try to use conventional techniques since we know we are limited in the amount of money we can spend on fundamental research. Frequently, the choice is to work with instrument manufacturers, which requires full cooperation and interchange between the producer and vendor. This is not always possible because of proprietary requirements. An active program at NBS should help the development of eddy current inspection devices.

In conclusion, seminars dedicated to free exchange of information among users, potential users, and vendors, such as displayed at this workshop, should be a good stimulus to better understanding and utilization of eddy current techniques.

#### Discussion

Question: You mentioned you had Kelvin bridge samples checked by NBS and that, subsequently, these were rechecked. Over a period of time, did the conductivity change?

Answer (Mr. Burley): In some cases, yes. One of the problems is that to cover the complete range of conductivities, stable alloys are not always available. However, most of the standards have remained constant for many years. Wear and scratches are usually the prime cause for replacement.

Question: The Kelvin bridge is a DC determination of an AC quantity. Is there a significant variation between bridge samples?

Answer (Mr. Burley): For the purposes of certification, most requirements refer to ASTM B193, which is a DC technique. Our philosophy has been to calibrate our eddy current meters against DC resistance standards. Since eddy currents measure only near surface conductivity, while DC measurements are volumetric, there could be considerable difference if surface

structure and chemistry are significantly different from volumetric properties. Samples which display such properties are not used for our standards.

Question: What order of magnitude of variation are you seeing in your standards, say, for the worst case?

Answer (Mr. Burley): One or two percent.

Question: If you take a general piece of plate or sheet and measure conductivity variation over the sheet that is supposed to be homogeneous, how large a variation do you get?

Answer (Mr. Jones): Several percent. We would not be surprised with two percent. When you approach the butt end or head end of the original ingot, you are quite likely to find a larger variation.

Question: What sort of variation do you get in the middle away from the ends?

Answer (Mr. Burley): Not more than 1-2 percent when you get to the final rolled product, say quarter-inch thick plate. If larger variations are found, they will be due to changes in chemistry, differences in cold working, or differences in thermal treatment. My earlier figures showed these variations may be several percent IACS.

Question: On production line, how do you control temperature so that it does not produce errors far greater?

Answer (Mr. Burley): For reporting or certification purposes, we measure samples in the laboratory and allow them to come to the same temperature as the standards. When measurements are made in the plant, samples may not be at the same temperature as standards; only qualitative values can be obtained. But in most cases, you are sorting and you are not too concerned since all readings are being shifted in the same direction.





## EDDY CURRENT INSPECTION OF GAS TURBINE ENGINES

Robert A. Betz

NDT Development  
Pratt & Whitney Aircraft Group  
United Technologies Corporation  
East Hartford, CT 06108

All of the many capabilities of the eddy current inspection method are used in the development, manufacture, and maintenance of gas turbine engines. It is used for flaw detection, material and coating thickness measurements, material sorting and identification, metallurgical condition monitoring, and electrical conductivity measurements. It is used to inspect raw materials, parts during manufacture, and as a service routine, some are unusual; many are common to all users of the method and some are peculiar to the industry. Anything approaching a complete discussion of its applications would fill a good sized book. For my purposes here, a few examples of the kinds of application that it finds in the field of gas turbines may serve to illustrate its usage.

The performance of a gas turbine engine improves as the temperature of the exhaust gases increases. The maximum operating temperature, however, is limited by the turbine parts, particularly the first turbine blade. There are, of course, limits to the temperature increases that are possible through the development of improved materials. An alternative approach, air cooling, has therefore been extensively developed over the past ten to fifteen years. Here the blades are made with internal passages through which relatively cool air is circulated. Such schemes require that the wall thickness be measured because the blade wall should be as thin as possible for most efficient cooling, but, since the blade is highly stressed, too thin a wall can lead to failure.

The cross-section of an air-cooled blade is shown in figure 1. In this

particular part, the thinnest, and therefore the most critical, area is at the trailing edge cavity as indicated. The shape of the part is that of an airfoil so that it has a nonconstant

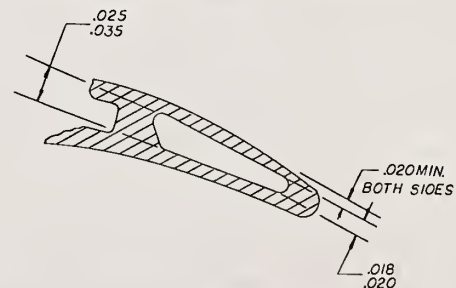

Figure 1. Cross section of a portion of an air-cooled turbine blade.

geometry on each side and from end to end. The minimum wall can occur on either side and at any location along the length of the blade, thus making an ultrasonic measurement impractical. The problem of testing blades was solved using a phase-sensitive, eddy-current instrument of the type developed by Dodd at the Oak Ridge National Laboratory. The use of a purely phase-sensitive instrument virtually eliminates the lift-off problems that arise because of the geometry and makes it possible both to locate the minimum wall and to measure its thickness. The technique has proven to be rapid, reliable, and capable of measuring the thickness within  $\pm 0.002$  inches.

Another application is the measurement of a multilayer coating. An experimental coating system using three layers is shown in figure 2. The problem was to determine if each layer fell within the prescribed thickness range. The first layer, applied directly to a nonmagnetic nickel-based alloy, is very



high in nickel and therefore magnetic. The middle layer, being a mixture of the nonconductive top layer and the magnetic first layer, is less strongly magnetic. The properties of the various layers suggested that an eddy current test might be used to make the measurements. Because the coating system is a complex one, an impedance analysis type of instrument with a storage oscilloscope readout was used to study the problem. Figure 3 shows the impedance

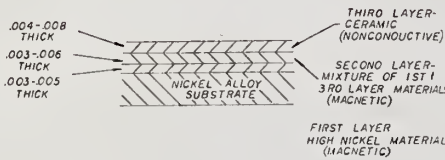

Figure 2. Three layer coating.

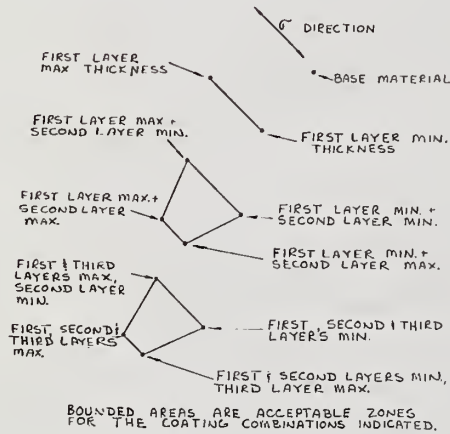

Figure 3. Impedance plane response for multilayer coating.

plane relationships of various thickness combinations of the three layers. The areas defined by these maximum and minimum points represent an acceptable thickness for each layer. Since the areas do not overlap, the acceptability of the thickness of any layer can be determined, provided that the lower layers are within their required thickness range.

Gas turbine engines use high quality bearings which are required to have a long life; any possible premature failure is cause for concern. During grinding of the bearing races, localized overheating of the surface can sometimes

occur. This overheating results in material anomalies. Depending on the conditions that generated the anomaly, a number of undesirable metallurgical changes can occur. In the worst case, the area includes both retempered and rehardened material while in the simplest case only a residual stress field results. Because these bearings operate at very high stress levels, any of these conditions can result in a premature failure. Fortunately, all of changes in metallurgical structure result in a local change in the permeability of the material so they can all be detected with an eddy current test. Further, each condition has its own characteristic response by which the eddy current test can identify the condition that is present.

Up to this point, we have been discussing manufacturing inspections. However, eddy current methods are also widely used for service inspections. In fact, the majority of the flaw detection applications are in this area.

Gas turbine engines, as with any rotating machine, are subject to vibration and the resulting fatigue damage. For most parts, fluorescent penetrant inspection is used to detect this damage, but there are some cases where this method is not satisfactory. One of these is in the root of fan blades where vibration gives rise to both fatigue damage and a mild surface galling. The latter condition interferes with penetrant inspection because it tends to close the surface opening of the damage. An eddy current test is therefore used on these parts. Specially contoured probes are used to maintain coil position and alignment because the area of interest is adjacent to a fillet radius as shown in figure 4.

A major advantage of the eddy current method in service inspection is its adaptability to remote inspections. By using some ingenuity, it is often possible to make special probes which can be used to perform internal inspections without engine disassembly. This kind of application does not always allow maximum sensitivity to be obtained, but where adequate sensitivity can be obtained, it saves the considerable cost of teardown and rebuilding.

As the examples cited may have indicated, there are a wide variety of

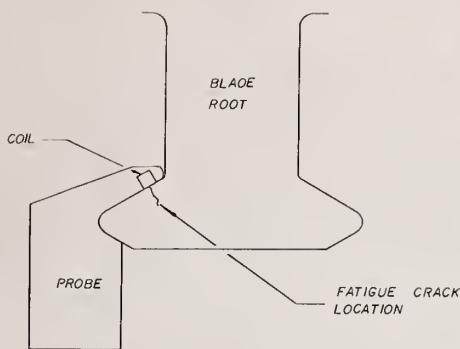

Figure 4. Fatigue crack inspection of fan blade roots.

eddy current applications in the industry, and to cover this range, a considerable diversity of equipment is required. While it would be nice to have one piece of equipment that would be all things to all tests, this does not appear to be very likely. For the most part, there does seem to be commercially available equipment that can solve those problems that lend themselves to the eddy current approach; it is just that the greater the number of jobs to be done, the larger the number of different instruments one must have available. The fact that so many jobs can be done should not be taken as meaning that new equipment developments are not needed. With new or improved equipment and techniques, it may be possible to find more applications or to significantly improve those that are already in use. Improved sensitivity to subsurface flaws, for example, would be a welcome improvement in certain applications. For improved capabilities, however, most users must depend on the equipment manufacturers; few users are in a position to develop new instrumentation. Even when a user does have the capability to make new equipment developments, the chances of such equipment being used outside his own facility are slim unless commercial exploitation follows.

The area of reference standards is an extremely large one. The desirability of having traceable standards is quite obvious, but the problems associated with such a task appear formidable. The way appears relatively easy in only a few cases. Let us consider the reference standards required for a few typical applications.

The checking of aluminum alloys for hardness requires good conductivity standards. This is an area that is currently being studied and that is to be presented in more detail by others. There seems to be little reason why such a program should not eventually be successful.

How one establishes uniform reference standards for other types of tests is not so apparent. Consider coating thickness measurements as an example. If only relatively few (say a couple of dozen) combinations of base material and coating need to be considered, the problem would probably be manageable. Unfortunately, this is not the case. In a large company, there may be as many as 30 or 40 base material-coating combinations that could require measurement, exclusive of nonconductive coatings. Throughout the country, the number of combinations must be gigantic. Then, there are always the unusual cases to be considered, such as the three layer coating discussed earlier.

Even more difficult from the standards point of view are tests such as the blade wall thickness measurement that has been discussed. Here, the only practical calibration is an indirect one because one cannot make a direct mechanical measurement of the reference masters. To do so requires removal of the opposite wall which changes the eddy current response. To calibrate this inspection, three blades were chosen that gave high, low, and midrange response. Using these to establish a uniform instrument set-up, enough parts were sectioned and mechanically measured to establish a calibration curve that related actual wall thickness and eddy current instrument meter reading.

Reference standards for flaw detection could well be a fertile field of investigation. Over the years, users and manufacturers of eddy current equipment have come up with a wide variety of methods for calibrating equipment to do flaw detection. These have included round file notches, drilled holes, electrical-discharge machined (EDM) notches, machined rectangular notches, and machined "V" notches. While any of these can be used to establish a repeatable machine set-up level, there would seem to be considerable question about how they relate to one another and to real flaws. In physical



appearance, an EDM notch, especially a narrow one, superficially appears to be a better simulator of a natural crack than does a drilled hole. But how significant is a physical similarity? A question that has been raised and never fully answered is whether an artificial standard can truly simulate a real crack. Cracks are the result of stresses within the material, and there is usually some residual stress field remaining that can modify the eddy current response. How true is this idea, and is it true for all types of cracks in all materials? These are only a few of the dozens of questions that come to mind when considering this particular aspect of eddy current standards.

The eddy current inspection method has become a major tool for the resolution of problems not amenable to solution by other nondestructive testing methods. Its application in research and development programs and in manufacturing and service applications is essential for any well-rounded nondestructive testing program. Advancing gas turbine technology will require continuing development of inspection techniques, equipment, and standards.

Comment (Mr. Weismantel): I think one of our problems in the NDE area is that we keep trying to make notches to represent the flaw we are trying to find. The purpose of an artificial defect is to make a reproducible condition so some facility on the other side of the country can set up that particular condition, and essentially work to the same sensitivity or a similar sensitivity. I do not think that we will ever get to the point where we will be able to use a notch to represent the flaw you are looking at, because flaws vary so much. The purpose of the standard is not to represent the flaw, but to bring you to a point where you can find the flaws that you have shown. This you can do under certain conditions.

Comment (Mr. Brown): I am not sure whether to make these comments now or later when we get into the nuclear area. But, I wanted to pass on some experiences I have had with EDM notches. They are not all alike. I had some EDM notches made and the person who was making them brought the electrode down on the tube and moved it back and forth a little bit so that the end of the

electrode would be curved just like the tube, and then he moved it over and made the notch. He said, "I do that all the time when I am making ultrasonic notches, and it does not cause them any trouble." I found tremendous signals from places where he had burnished the electrode. If you are not aware of this effect you may think the signals are coming from the notch of the standard; they are not, they are really coming from the burnished place. If you use EDM notches as standards for small notches, be careful when they do not appear to be consistent. It apparently has something to do with the conditions under which the notches were made, the oil, temperature, etc., and do not let them burnish the electrodes.

Question: How do you validate your measurements for the case of the multi-layer laminate you talked about?

Answer (Mr. Betz): As I said, we did it as a feasibility study. What we did to get the data that we obtained was have our people make us a maximum and minimum coating on the base material, and then a maximum and minimum second layer to get the proper combinations, and then we went to a nonconductive shim stock for the third layer.

## EDDY CURRENT EXAMINATION IN THE NUCLEAR INDUSTRY

Allen E. Wehrmeister

Babcock & Wilcox Company  
Lynchburg Research Center  
Lynchburg, VA 24505

This paper discusses eddy current testing in the nuclear industry. Almost all eddy current inspection at Babcock & Wilcox (B&W) is for tubing; tubing specifically for nuclear steam generators. Inspection is performed during tube manufacture and after installation in steam generators.

An automatic shop tube inspection station is shown in figure 1. Straight lengths of tubing are inspected for anomalies formed during the manufacturing process. The types of tube anomalies are predictable and readily detected with the eddy current method. The consistency of daily shop operation yields a highly reliable test system.

Tubes installed in steam generators are subjected to a more complicated test environment. Field inspection of these tubes is the primary purpose for my participation in this NBS workshop. Two types of steam generator concepts are widely used, the recirculating steam generator (RSG) or U-bend generator and the B&W designed once-through steam generator (OTSG). The OTSG has all straight tubes, no U-bends. The test problems encountered in these generators can be similar. I will discuss some of the inspection problems encountered, how some have been overcome, and others that still require a solution. These problems have a significant adverse impact on the reliability of eddy current examinations of installed tubes

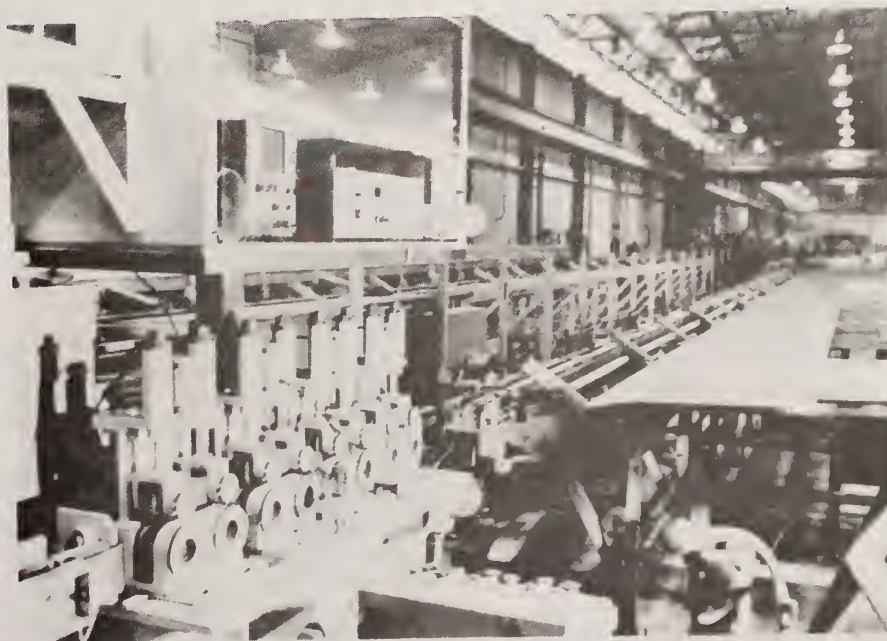

Figure 1. Automatic eddy current inspection station for steam generator tubes.



What is an OTSG test environment? The OTSG is about 60 feet high and contains 15,500 Inconel 600 tubes (see fig. 2). Superheated water (referred to as primary side water) enters the top of the generator and exits at the bottom. The secondary side water (on the outside of the tube) enters at the bottom and converts to steam, exiting at the top. There are 15 tube support plates located along the length of the generator. The supports are made of 1-1/2 inch thick carbon steel plate. Each tube passes through each support.

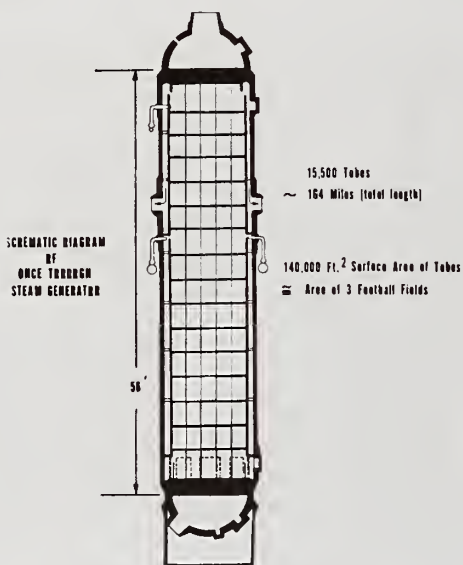

Figure 2. Schematic of Once Through Steam Generator (OTSG). Vertical tubes are supported by 15 horizontal plates. Two OTSG's are in each nuclear steam system.

The tube is inspected for general wall thinning as a probe is driven into the steam generator. Examination for discrete flaws is made while the probe is being withdrawn. The probe drive and manipulator system are sketched in figure 3. The eddy current signals are recorded on magnetic tape and on a strip chart for post analysis. B&W uses a test frequency which produces about one standard depth of eddy current penetration in the tube wall. Typical signals at this test frequency are displayed as shown in figure 4 (from artificial flaws). A range of signal orientations (phase angles) are used to establish flaw through-wall penetration.

The data are taken to a data analysis center for post-test review. When "flaw-like" signals are detected, the questionable region is examined again at

other test frequencies for more information. Multi-frequency examination is used to validate anomalies and perform flaw characterization. Leaks between the primary and secondary sides are of primary concern, but eddy current examinations do not detect leaks. Leaking tubes are identified with hydrostatic tests. Eddy current examination detects tube anomalies which may or may not have leak potential.

Any phenomenon that interferes with the flaw signal shape or orientation affects the ability of an analyzer to interpret the data. The support plate produces an eddy current signal pattern like a horizontal figure eight. The tube region within  $\pm 1/2$  inch of each edge of a support plate is subject to the possibility of a flaw signal mixing with the tube support signal. For each tube support plate, therefore, about 2 inches of tube is masked by an interfering tube support plate signal. That represents 32 inches out of 56 feet of tubing; and as it turns out, these areas are the most critical regions in the generator. The instrument on the right of figure 5 is a computer system that was designed to eliminate the effects of the tube support signals during analysis. This signal processing makes the signal look as though it were from free and clear tubing.

Figure 6 illustrates the computer signal processing concept. When a differential eddy current coil system detects a crack in free and clear tubing, a classical flaw signal 1 is generated. When one edge of a support plate is detected, one half of the horizontal figure-eight pattern is generated 2. When a crack is at the edge of a support plate, a distorted tube support signal (or a distorted flaw signal) is generated 3. Subtracting the tube support signal from the distorted signal results in a classical flaw signal that can be interpreted.

Figures 7 and 8 are examples of actual inspection signals before and after signal processing. The resultant indications are classical flaw signals from the outer surface of the tube. This analysis is not clear from the distorted support plate signal deviation alone. We must analyze that deviation and judge its significance. When support plate signals are distorted, they represent a deviation from normal, something detected. Unless the signal deviation is studied and its cause established, we do not really know what has been detected.

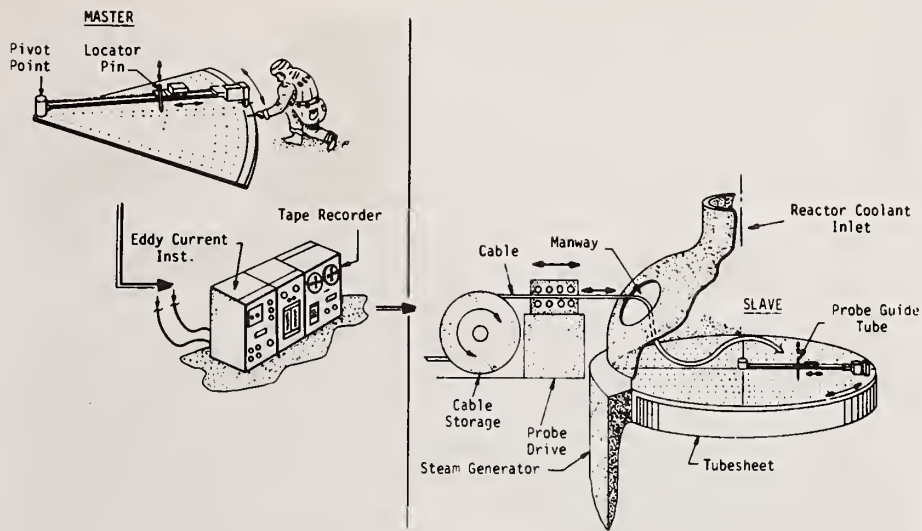

Figure 3. Master/Slave probe manipulator concept. Probe position is verified with a television system prior to inserting probe in tube. The Master template and eddy current instruments are remote from the OTSG.

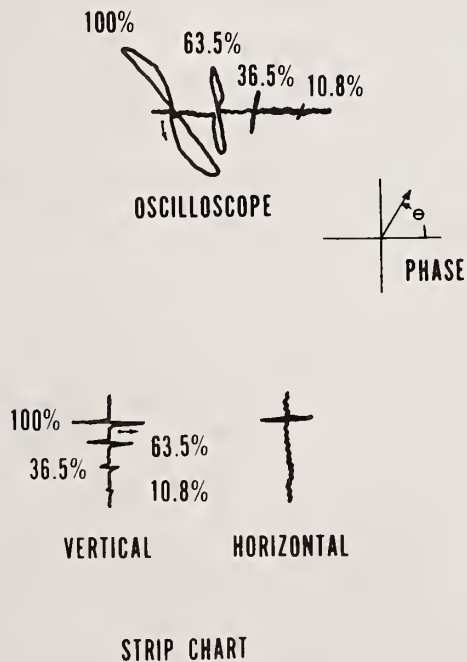

Figure 4. Oscilloscope and strip chart tracings of artificial anomalies; 10.8%, 36.5%, 63.5%, and 100% of the tube wall thickness.





Figure 5. The first Computer Eddy Current Analyzer (CECA-1) shown during field post-analysis.

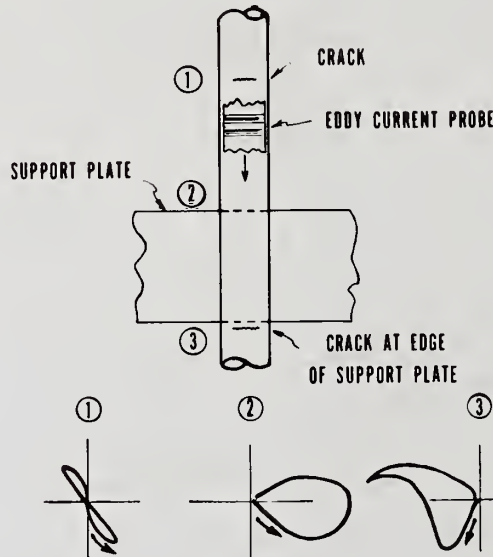

Figure 6. Illustration of the computer signal processing concept.



Figure 7. A distorted tube support plate signal and the resultant flaw signal after subtracting a good support plate reference signal. Tracings of actual field data.

For example, flaws are not always the cause of distortion or signal deviations. The distorted signal in figure 9 produced a "chatter" indication when analyzed with the computer system. "Chatter" or ID ripples are produced during tube manufacture. It is not considered detrimental, unless its signals mask all flaw signals. To eliminate ID chatter signals is to improve analysis.



Figure 9. A distorted support plate signal and the processed non-flaw resultant signal. Tracings of actual field data.

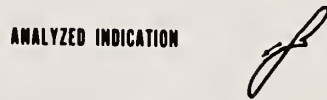

Figure 8. A distorted upper tube sheet signal, a reference tube sheet signal, and the processed resultant signal. Tracings of actual field data.

Figure 10 shows what the effects of cold working or residual stress have on a flaw. Forty percent and sixty percent EDM notches were cold worked (rubbed with the shaft of a screw driver) in the laboratory. In each sample, the phase information was distorted, yielding incorrect information about flaw depth. The distorted signals made the flaws appear deeper. A dent and a 100 percent through

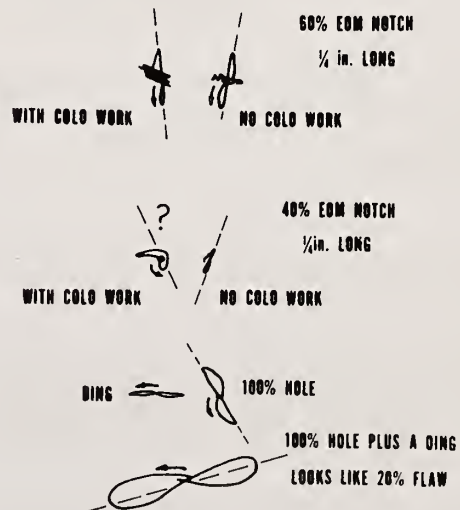

Figure 10. Experimental signal tracings, illustrating the effects of "cold working" on signal shape and orientation.



wall hole, however, appeared like a shallow flaw. These are signal analysis (flaw characterization) problems that develop because of external influences on real flaws. What other mechanisms are at work?

The signal shown in figure 11 was monitored during repeated in-service inspection. Analysis indicated that a flaw was growing, and that it was deep. When the tube was removed from service, the eddy current indication was analyzed as shallow. Destructive tests confirmed a shallow flaw. The "effect" (stress?) that caused the distorted information disappeared when the tube was removed from service. The cause of the distortion, or the "effect" producing incorrect analysis, has not been determined. The development of a technique to eliminate the influence of this "effect" is required.

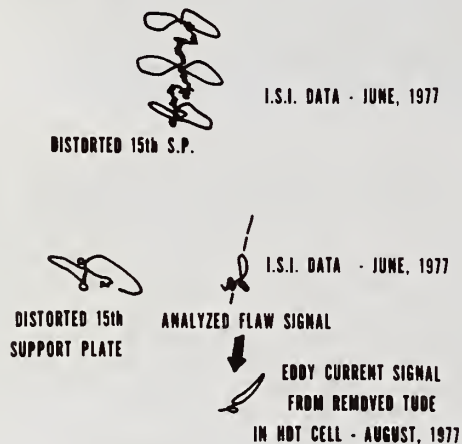

Figure 11. Tracings of actual field data illustrating the effect of "other factors" on signal shape and orientation.

#### Discussion

Question (Mr. Ammirato): Are you able to inspect near the tube sheet?

Answer (Mr. Wehrmeister): Yes, the tube sheet and the tube support edges are similar; you get the same kind of response. Each can be analyzed with the computer system.

Question (Mr. Ammirato): How is the tube sealed in the support plate, compared to the tube sheets?

Answer (Mr. Wehrmeister): The tube is welded and rolled into the tube sheets.

It is not held by the tube support plates, it is only confined to a region.

Question (Mr. Weismantel): Could you give me some idea of the sizes of the defects you are seeking and what the sensitivity level is?

Answer (Mr. Wehrmeister): We look for 20 percent throughwall indications in accordance with Reg. Guide 1.83. B&W tubing has a 0.037 inch wall.

Question (Mr. Weismantel): What is the length of that 20 percent throughwall?

Answer (Mr. Wehrmeister): No length is specified.

Question (Mr. Weismantel): Regardless of whether it is 20 thousandths long or 100 thousandths or ten inches?

Answer (Mr. Wehrmeister): That is right.

Question (Mr. Weismantel): The interference you obtain from support plates, I gather you tried higher frequencies to null out that interference?

Answer (Mr. Wehrmeister): Higher frequencies do not null it out; they lower the sensitivity to outer tube surface anomalies.

Question (Mr. Weismantel): You would not see the support if you went to a higher frequency. Would that give you an adequate inspection?

Answer (Mr. Wehrmeister): No, shallow OD discontinuity signals would be smaller and approach a horizontal position, thereby making detection difficult. Higher frequency is used when we are looking for phase angle relationships to establish depth.

Question (Mr. Weismantel): Are your support plates carbon steel or stainless?

Answer (Mr. Wehrmeister): Carbon steel.

Question (Mr. Titland): Do you calibrate your computer on the support plates inside the steam generator, or on a model?

Answer (Mr. Wehrmeister): We use the support plates in the generator.

Question (Mr. Brown): Do you use one support plate chosen because you like the looks of it, or do you take several and average them.

Answer (Mr. Wehrmeister): We use those that appear most consistent, we use signals from a previous inspection.

Question (Dr. McMaster): Do you have much evidence of stress corrosion signals in these tests?

Answer (Mr. Wehrmeister): We have not established the cause of some signals, but none to date resemble what you might expect from stress corrosion.





## EDDY CURRENT INSPECTION SYSTEMS FOR STEAM GENERATOR TUBING IN NUCLEAR POWER PLANTS

Clyde J. Denton

Zetec, Inc.  
Issaquah, WA 98027

### 1. Introduction

Eddy current inspection of steam generator tubing in commercial nuclear power plants has evolved from a simple manual effort to test two tubes during 1970, to completely automated systems inspecting thousands of tubes today.

Although improvements have been made in the recording and interpretation of data, as well as in mechanical fixturing, the basic eddy current test is still performed in the same way.

The following is a brief description of the eddy current test technique.

An alternating voltage is impressed across two test coils. The magnetic field developed by current flow in the test coils causes eddy currents to flow in the tube wall. The corresponding magnetic field caused by eddy current flow in the tube wall is out of phase with the field developed by the current in the test coil. Since, these fields tend to cancel one another, the coil voltage is decreased in proportion to the magnitude of eddy current flow in the test piece. The magnitude of the eddy currents in the test piece, thus the coil voltage, is dependent on the electrical properties of the tube being tested. The electrical properties which affect the flow of eddy currents are permeability and conductivity. In non-magnetic materials, such as Inconel and 300 series stainless steel, conductivity is usually the only significant variable. When the effective conductivity decreases due to a discontinuity in the tube wall, the coil voltage increases in direct relationship with the effective conductivity change. Thus, the amount of increase in coil voltage is related to the size of the discontinuity. The coil voltage is sinusoidal; thus, it can be described with a single vector having

magnitude and phase. The Zetec eddy current system provides a method to read out and record the two quadrature components of the test coil voltage vector.

### 2. Discussion

The system employed to inspect steam generators uses eddy currents as the probing media to measure variations in the conductivity of the tube wall being tested.

An alternating voltage is impressed across two test coils. The magnetic field developed by current flow in the test coils causes eddy currents to flow in the tube wall. The corresponding magnetic field caused by eddy current flow in the tube wall is out of phase with the field developed by the current in the test coils. Since these fields tend to cancel one another, the coil voltage is decreased and phase shifted in proportion to the magnitude of eddy currents in the test piece; thus, the coil voltage is dependent on the electrical properties of the tube being tested. The electrical properties which affect the flow of eddy currents are permeability and conductivity. In non-magnetic materials, such as Inconel and 300 series stainless steel, conductivity is usually the only significant variable. When the conductivity decreases due to a discontinuity in the tube wall, the coil voltage increases and phase shifts in direct relationship with the depth and volume of the conductivity change. Thus, the amount of increase in the coil voltage and the phase change is related to the size of the discontinuity.

The coil voltage is sinusoidal; thus, it can be described with a single vector having magnitude and phase. The eddy current test system used in steam generator inspection provides a method

for reading out the two quadrature components of the test coil voltage vector.

The two test coils are electrically connected in opposite legs of the balancing network in the eddy current instrument. Thus, the tube is being inspected by the differential technique. The differential technique decreases the effects of probe motion, temperature variations, and geometry differences. However, changes in nominal wall thickness are not detected.

The electronic portion of Zetec's eddy current system contains five separate instruments. The main instrument is a Zetec/Automation Industries EM-3300 Eddy Current Tester. The EM-3300 has a continuously variable frequency from 1 kHz to 2.5 MHz with a digital readout to indicate the operating frequency. The readout is accomplished on an X-Y memory oscilloscope which is an integral part of the EM-3300. The instrument has X-Y outputs of plus or minus 8 volts and a frequency response of DC to 100 Hz.

The output of the EM-3300 is connected to a Zetec FM-2300S Two-Channel Magnetic Tape Recorder. The tape recorder also has input and output capabilities of plus or minus 8 volts and DC to 100 Hz frequency response. In addition to recording the X-Y channels, the tape recorder has a microphone to allow tape recording tube identification and other pertinent data. The circuits in the recorder are designed to allow voice insertion and retraction without interaction with the test data.

The output of the FM-2300S is connected to the input of a Two-Channel Strip Chart Recorder. The strip chart recorder has a frequency response range from DC to 100 Hz, and it is capable of displaying a voltage input of plus or minus 8 volts. The strip chart recorder provides two functions. First, it provides a permanent record which can be scanned rapidly for initial inspection results. Secondly, since it monitors the output of the magnetic recording, it assures that the recording equipment is functioning properly.

The fourth instrument is a Zetec Model I Communications Amplifier which allows voice contact between four stations with variable inputs and outputs for all stations. The amplifier con-

tains high and low filters to decrease normal plant noise.

The fifth instrument is used to assist in data analysis and will be discussed at length later in this presentation.

The eddy current test system is normally used in conjunction with a mechanical system which positions the probe over the correct tube and then inserts and withdraws the probe. The insertion rate is approximately two feet per second and the withdrawal rate is one foot per second. The inspection is performed during the retraction of the probe.

When the probe is inserted the proper distance, the tube number is written on the strip chart and the voice entry is made on the magnetic tape, then the probe is retracted while the recording systems are operating.

When the magnetic tape is completed, the tape and its associated strip chart records are taken to a remote location where they are analyzed by an ASNT-TC-1A Level IIA qualified interpreter.

The equipment used to analyze data consists of a tape recorder identical to the one used to record the data, and a vector analyzer which more realistically should be called an electronic protractor. The "analyzer" provides a rapid means of measuring the phase angle and amplitude of signals.

The basis for phase analysis eddy current testing can be simplified and explained as follows. Given four concentric tightly fitting tubes as shown in figure 1, and starting with the

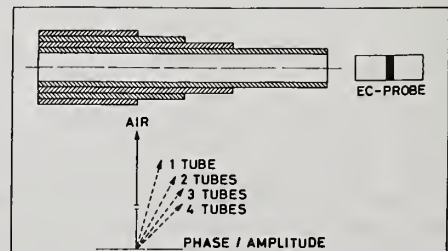

Figure 1. Phase relationships.



probe in air, first the air vector is obtained. When the probe is inserted in the smallest diameter tube, eddy currents flow in the tube wall with a resulting magnetic field. The resultant coil voltage vector is decreased in amplitude and phase shifted. As the second tube is slipped over the probe area, the vector amplitude is further decreased and phase shifted. The current flowing in the second tube is a function of the magnetic field from the coil and the magnetic field associated with the current flow in the first tube. This process continues for each tube with the current flow in each tube dependent on the current flow in the adjacent tubes. The eddy currents are not affected (in a nondefective tube) by the laminar type tube to tube interface. Thus, this example can be expanded to include eddy current flow in a solid tube wall. The current flowing in any circumferential tube segment has its own distinctive phase and magnitude. The exact phase and magnitude at any point in the tube wall is dependent on the test frequency and the conductivity of the tube being tested. The eddy current test system's function is to detect and record variations in the magnitude and pattern of eddy current flow in the tube wall.

When a differential probe is passed through a tube with a defect, the signal is formed as in figure 2. Point 1 of figure 2

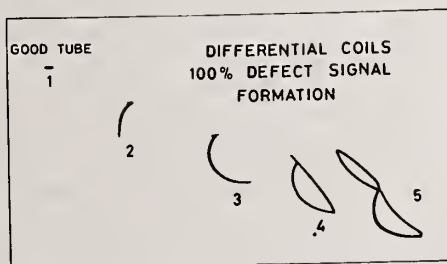

Figure 2. Signal formation.

is the signal from a good tube, point 2 shows the first coil approaching the defect, point 3 shows the coil directly centered in the defect, point 4 shows the first coil leaving the defect and the second coil entering the defect, and point 5 shows the completion of the signal.

Figure 3 shows three defects tested at three different frequencies. The

probe was a differential bobbin type and the two defects not penetrating through the wall are on the outside surface of the tube.

Figure 4 is essentially the same as Figure 3 except additional defects are shown and the optimum frequency, wall thickness, and conductivity are used.

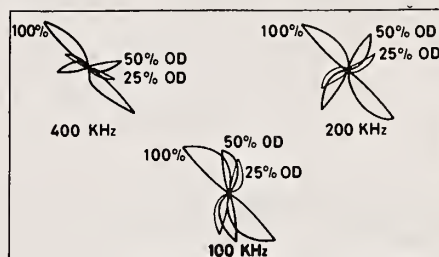

Figure 3. Signal phase angle comparisons at three frequencies.

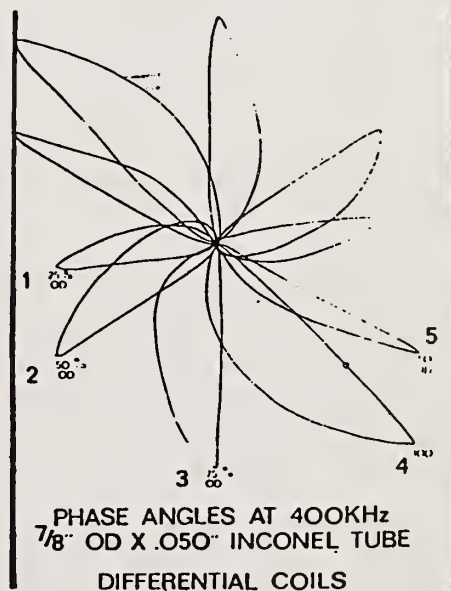

Figure 4. Actual phase angles at optimum test frequency.

Taking the data from figure 3 and plotting a calibration curve of percent penetration of the tube wall versus signal phase angle results in the data presented in figure 5.

The eddy current test system has been shown to exhibit a long term two sigma measurement error of plus or minus 5 percent under actual field conditions.



Plotting this information versus the calibration curves in figure 5 results in the measurement error curves shown in figure 6.

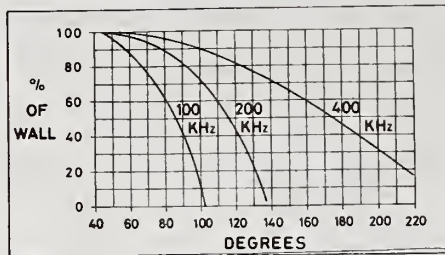

Figure 5. Calibration curves for three frequencies.

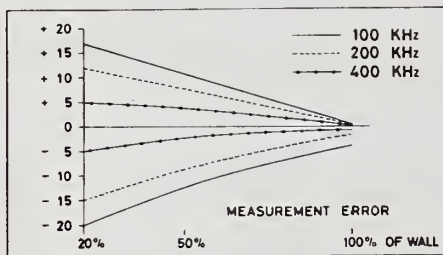

Figure 6. Measurement error comparisons at three frequencies.

Note that the test sensitivity shown in figure 5 indicates more sensitivity at 100 kHz than at 400 kHz, but the measurement error curve shows twice as much error at 100 kHz. This is one of the considerations which determined the selection of 400 kHz for flaw detection in 7/8 inch and 3/4 inch x .050 inch wall Inconel 600.

The mechanical portion of the Zetec eddy current test system varies to accommodate the conditions imposed by the designs of the various steam generator vendors.

Basically, all of the systems function as follows. A template with tube number identification is temporarily installed in the steam generator. A rotatable circular fixture with a minimum of two independent motions is installed over the template. The fixture operator positions the probe guide tube and its associated light and TV camera over the tube to be inspected. The probe/pusher puller mechanism is used to insert and retract the probe. Test speeds of over 100 tubes per hour are achievable when

the tube test length is short. Thus, it is obvious that fixture positioning time is relatively short. The complete data station and fixture control center can be operated up to 150 feet from the steam generator, although shorter distances are recommended.

## Discussion

Question (Dr. Mc Master): You did not mention the Russians. Are they using your services?

Answer (Mr. Denton): The reactors that we have been involved with are in Finland. What they have done is copied the Hanford tube sheets; so it is essentially the same system. The Hanford tube sheet has a dual pipe going in and out. The inlets are on top, outlets on the bottom. The Russians merely took that and made it two different tube sheets, with an inlet and an outlet, and the tubes still go both ways.

Question: On the B&W steam generator, do you use a template?

Answer (Mr. Denton): Yes. There was a template. I do not know if it is NRC or ASTM code--somewhere in the system it says you have to positively identify the tube. That sounds great when you write it, but realistically when you are 100 feet away, to check this thing, you have to put on two pairs of coveralls, boots, gloves, etc., go inside and say, that is the right tube, all right. So the template and TV system eliminate that. Even if you have a system that has dials on it and it does not really require a template, you may still put it in just to satisfy the positive ID of the tube.

Question (Dr. Green): Doesn't one person often take the data while a second person analyzes it?

Answer (Mr. Denton): Yes. The data is stored on magnetic and paper tape and no analysis is done on the job at all. There are many reasons why we do it this way.

Question: Are there any changes in the characteristics of the probe due to the radioactive environment?

Answer (Mr. Denton): No.

Comment (Mr. Wehrmeister): Water in the generator tube also does not affect the test. We inspect generators prior to draining in what is called the critical path. It costs upward of a quarter of a million dollars every day a generator is down; so you want to complete the inspection as quickly as possible. So we do inspect them while they are still full of water.





## USE OF ROUND ROBIN TESTS TO DETERMINE EDDY CURRENT SYSTEM PERFORMANCE

E. R. Reinhart<sup>1</sup>

In-Service Inspection Incorporated  
333 Victory Avenue  
South San Francisco 94080

### 1. Introduction

The operational availability of a number of Pressurized Water Reactors (PWRs) has been reduced by the recent discovery of deformation and cracking in steam generator (SG) tubing in several operating reactors [1,2]<sup>2</sup>. The more severe deformation is known as denting and occurs in the area of the tube support plates. In-service inspection, during periods of reactor shutdown, is presently used to detect and analyze this problem. To satisfy regulatory requirements for in-service inspection of steam generators, the only inspection method presently used and accepted is eddy current testing (ET) [3]. For this inspection, differential coil bobbin type eddy current probes are inserted in the inside diameter (ID) of the primary side of the steam generator and drawn through the length of the steam generator. The present eddy current systems and techniques were evolved from technology developed during the early 1960's [4]. In-service inspection experience (training of inspectors, analysis of data, etc.) was primarily derived from the involvement of various groups with the Nuclear Navy. In the past, this test has been very successful in detecting such problems as wastage and corrosion in straight sections of steam generator tubing [5]. However, the recent occurrences of denting in the tube support area provide the inspector with complex eddy current signals that may mask flaws. Denting and "ovalization" of tubing also restrict access by the inspection probe. Questions have also been raised regarding the capability of the existing eddy current methods to

determine, in subsequent inspections, the extent of slow flaw growth to the degree necessary for judging the effect of remedial SG activities (change to all volatile treatment, etc.).

In response to the obvious need for improved NDE technology, considerable activity is being funded in NDE systems and development for SG inspection by EPRI, government agencies inspection groups, nuclear system steam suppliers (NSSS), and foreign groups [6,7,8]. Multifrequency ET, new ET probes, and ultrasonic systems are all in various stages of development. In light of the present SG problems, the utilities need to sort this NDE activity into the categories of expected near-term improvement (within six months) and mid-term improvements (within 12 months). The near-term improvements should have the potential to improve inspection performance for the next series of major in-service inspections (winter 1977) and for units that will be cleaned or where water treatment will be changed. The near-term improvements would therefore reflect system changes that are now ready for field use but require qualification. In the area of mid-term improvements, systems technology should be identified that is amenable to accelerated effort for incorporation into systems that can be used for fall 1978 in-service inspection. In addition, goals for long-term R&D activity should be defined.

To address these needs, as well as to define a baseline for existing SG

<sup>1</sup>Formerly with Electric Power Research Institute, Palo Alto, CA 94303.

<sup>2</sup>Figures in brackets indicate the literature references at the end of this paper.

inspection capability, EPRI recently initiated a technical round-robin program. Conventional NDE methods and advanced multifrequency ET systems were evaluated. A panel of in-service inspection specialists and theoretical NDE consultants observed and participated in the round-robin evaluations.

The results of this program will be used by EPRI in two areas.

(1) Plan long-range R&D projects for the EPRI Nuclear Division. This study will establish the performance level of present inspection systems and point out areas where long-range R&D activities should be conducted. Most of the short- and mid-term development effort in this area will be conducted by EPRI's newly established Steam Generator Project Office described below.

(2) Define NDE performance goals for the Steam Generator Project Office. The Steam Generator Project Office has been established by EPRI and member utilities to rapidly develop technology to alleviate serious losses in PWR plant availability caused by the previously-mentioned problems associated with steam generators. The Steam Generator Project office has identified NDE development effort as a key item in its plan for improved availability; it will therefore use the results of the technical planning study to focus attention on the areas that have the most potential for achieving near-term improvement.

Details of planning and conducting the study are presented in the following sections.

## 2. Planning the Program

Determining the nature of present SG NDE inspection problems, determining the performance of present and developing NDE systems related to those problems, and planning remedial action were considered the major objectives of initial EPRI activity in this area. From a review of past work in studying NDE system performance, conducted by EPRI and others, the following steps were taken in planning an initial study [9,10,11].

### 2.1 Definition of problem.

This first step in planning the study involved a compilation and study of available reports on the subjects of

SG tubing flaws and in-service inspection. Reports that were of particular value in planning the program are listed as references 12 through 17. These reports gave a fairly good assessment of the location, nature, and frequency of defects found in present pressurized water reactor (PWR) SG designs. Many of these reports were obtained from a literature survey conducted by Battelle Columbus Laboratories for this study.

Although there was considerable information on several types of SG problems, these reports lacked detailed information on the denting problem. For a better definition of this problem, an NDE specialist meeting was therefore held on February 24, 1977, at the offices of EPRI. From the results of this meeting, a better idea of the nature of the denting problem was obtained, along with considerable information to aid in planning an NDE performance evaluation study. Selecting the type and nature of the study is discussed in the next step.

### 2.2 Definition of study.

From the results of the NDE specialist meeting, the literature survey, and several additional communications, an EPRI Technical Planning Study (TPS-77-709) was selected as the vehicle for conducting further effort in this area. Technical planning studies are conducted by EPRI to support research and development planning for the engineering and economic feasibility of proposed technological development and/or hardware options. Such studies permit identification of the most promising options and the major technological issues which must be resolved before the initiation of a comprehensive research program. The technical planning study approach was also selected since this represents one of the most expedient EPRI methods (minimal contractor negotiation time, streamlined review and approval process, etc.) for responding to studying near-term utility problems. Major objectives of this study were defined as:

(a) First, the overall baseline performance of present NDE systems (including the operators) in response to a variety of defect types should be determined. This baseline would establish the nature and extent of future R&D activities.

(b) Second, the performance of several new inspection methods, tech-



niques, and equipment, should be evaluated to determine their potential for solving present NDE problems. Both field prototype as well as laboratory methods should be evaluated.

(c) Third, the study should be initiated and completed as soon as possible in order to transmit the information to the EPRI Steam Generator Project Office and other interested EPRI Nuclear Departments for use in planning comprehensive R&D programs.

### 2.3 Organization of the study.

Since the nature of the inspection problem was recognized as being very complex, and since EPRI needed to rapidly obtain as much comprehensive information as possible, a technical round-robin program, aided by theoretical and applied NDE specialists, was selected as the basis for the study. It was felt that the data from simulated in-service inspections, when combined with the analysis and observations of an expert review panel, would provide considerable insight into the various parameters affecting inspection system performance.

### 2.4 Details of the study.

This study incorporated the following details:

A. NDE Evaluation Panel. Under the direction of an EPRI Project Manager, a six-man NDE technology evaluation panel was used to assess performance of the various NDE systems. The panel was composed of one NDE inspection specialist from the following Nuclear Steam System Suppliers: Babcock & Wilcox, Combustion Engineering, and Westinghouse. The remaining three members were selected from the following independent groups: Battelle Columbus Laboratories, EPRI, and Southwest Research Institute.

Battelle and EPRI are independent research laboratories whereas Southwest Research represents an independent in-service inspection group. The above team, composed of both NSSS suppliers and independent laboratory representatives, was formed to lend credibility and objectivity to the project results. The above groups also supplied examples of defective tubing and aided in developing a realistic test program.

Each nondestructive testing system was evaluated by this panel in the following manner:

- (1) General impressions. Prior to laboratory tests, details of the system were described by the system supplier.
- (2) Scan of known defects. The panel was allowed to review the system in operation and review such details as data analysis, etc.
- (3) Scan of unknown defects. Data were then taken using a mockup containing a series of simulated defective tubing.
- (4) Summary of results. Based on the results of (1), (2), and (3) above, each panel member submitted his conclusions to EPRI regarding the performance of the NDE system under evaluation.

A mockup containing examples of defective tubing was essential to conducting the study and is described in the following section.

B. A key element in any study of in-service inspection performance is simulation of the inspection environment that the NDE system "sees." In this respect, a realistic mockup is essential. Since this study was aimed at determining current SG inspection performance as used in the nuclear industry, all three NSSS SG designs were considered. Looking at the present three SG designs depicted in figures 1, 2, and 3, the task of designing a realistic mockup initially appears monumental. This would be true unless one considers that the inspection systems to be evaluated in this study only have access to the tube sheet and inside surface of the heat transfer tubing. With respect to possible mockup configurations, table 1 presents various configurations that could be used for NDE performance studies or systems development. The mockup design selected for this study was configuration 3. An air transportable mockup was designed since several of the systems that were to be evaluated were in the laboratory or prototype stage of development, and transport of these systems from the laboratory was not feasible. Transporting the mockup to the various NDE development laboratories was also optimum from a scheduling and economics standpoint.



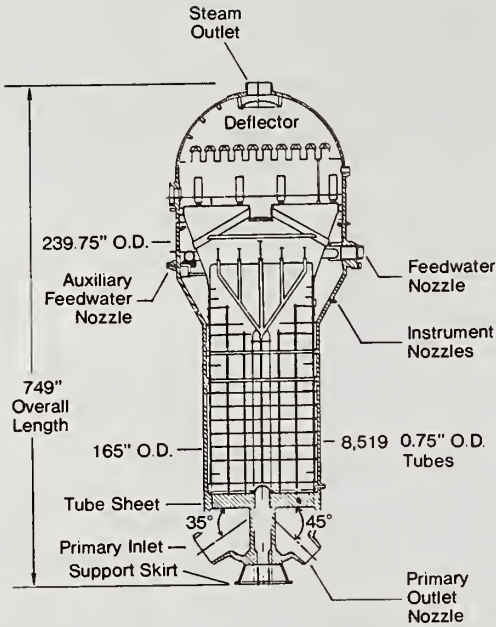

Figure 1. Example of U-bend steam generator design (similar to Calvert Cliffs # 1).

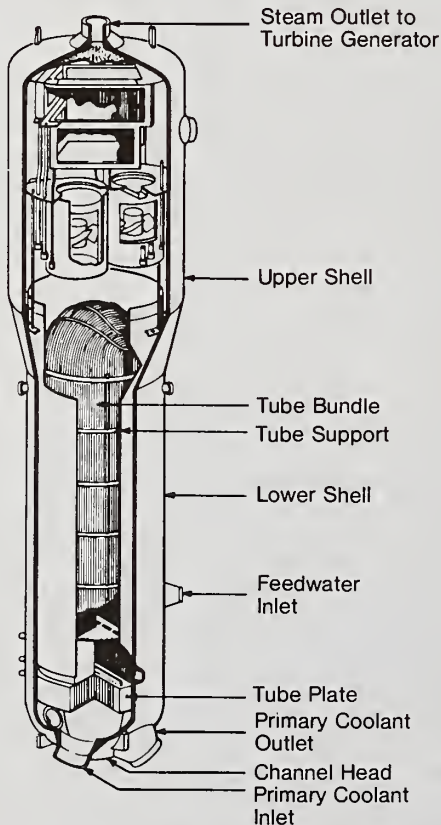

Figure 2. Second example of U-bend steam generator design (similar to Surry # 1).

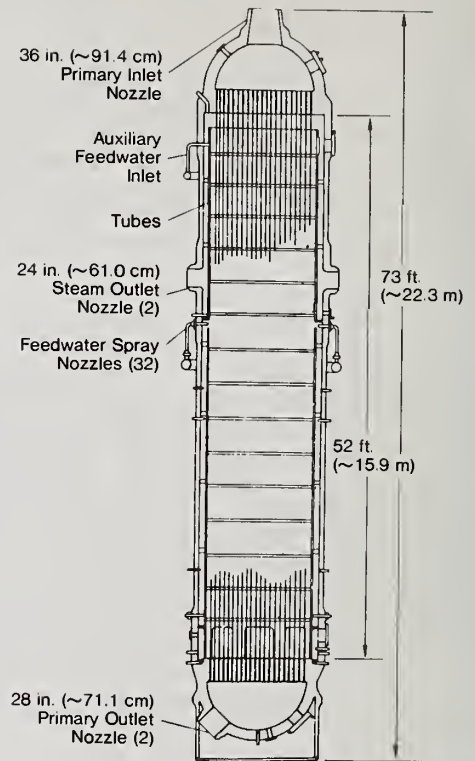

Figure 3. Once-through steam generator design (similar to OCONEE # 1).

Essential features of the mockup are shown in figures 4, 5, 6, and 7. The mockup was designed and built by Battelle Columbus Laboratories within one week of contract initiation. The mockup proved to be easy to transport and assemble at the test site, and could be used to evaluate a large number of SG tubing configurations, including tube supports and U-bends. The next section describes the samples used with the mockup to test the various systems.

C. Test Samples. Although the study addressed NDE problems associated with all existing NSSS steam generator designs, one tubing size for all the test specimens was selected to simplify the logistics of the program. For the same reason, samples were all 7/8 inch nominal OD (.050 wall) Inconel 600 steam generator tubing of a configuration typical to several SG designs, including the Westinghouse series 51 PWR steam generators. The tubing samples were either supplied by members of the NDE evaluation panel from existing test samples or fabricated specifically for the EPRI study. The samples included

Table 1. Steam Generator Mockup Configurations.

Mockup Configuration	Purpose	Key Elements in Design
1	Develop and evaluate NDE for inspection of the secondary side of the SG (OD inspection).	Complex access must be simulated with simulated tube bundles, outside surface of SG, tube supports, etc. This is probably a fixed site design. The space required depends on the SG design; however, it could be of limited height for inspection at only one level.
2	Develop and evaluate <u>total</u> NDE system for inspection of SG tubing from the primary side.	To evaluate total NDE system, including remote positioners, etc., total simulation of tube sheet geometry and distances is required. Realistic tubing lengths and U-bend geometry is also required. This design is probably fixed site and the overall height could be considerable (>50ft). (see Reference 5).
3	Develop and evaluate basic inspection system probe and instrumentation performance under simulated dynamic inspection.	Inspection environment could be simulated with single or limited number of tubes. Tube supports and vertical tube sheets are simulated with sleeves over the tubing. This design can be fixed or air transportable conditions.
4	Develop and evaluate NDE system or components under laboratory conditions, with laboratory controlled probe motion.	Simple tubing holder with probe motion controlled by simple probe drive mechanism. Tube distances can be as small as 6 inches (see Reference 10).



Figure 4. Air transportable steam generator mockup as shipped.

specimens loaned to the program for an ongoing Battelle Columbus/Brookhaven National Laboratory program through the courtesy of Dr. John Weeks of Brookhaven. The nature of the various samples were:

Notched Samples. These samples used electrodischarge-machined (EDM) notches to simulate narrow crack-like defects (fig. 8). EDM notches ranged in width from 0.005 in to 0.009 in. The flaws were machined at various depths, lengths, and orientations (axial, circumferential, and at 45° to the tube axis). Two samples were also machined with the same flaw, one with work hardening, one without.

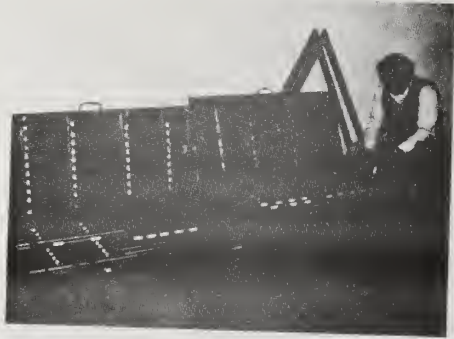

Figure 5. Mockup during assembly.

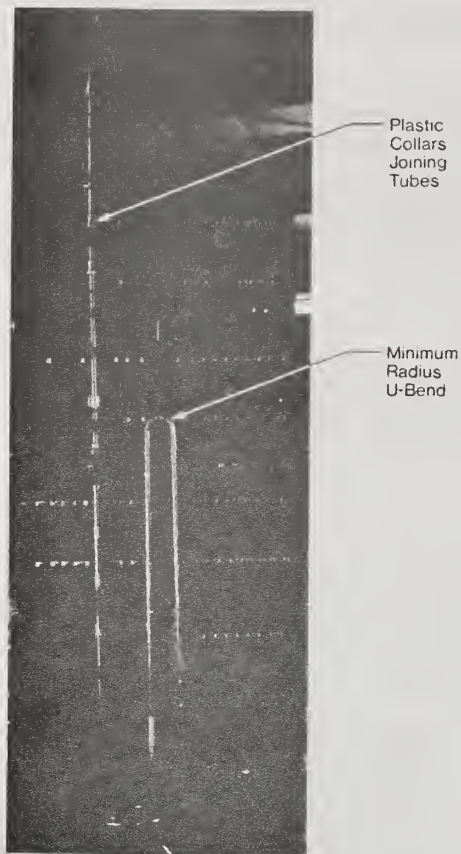

Figure 6. Mockup during simulated SG inspection as viewed by evaluation panel.



Figure 7. Mockup as seen by inspectors during simulated SG inspection, tubes on opposite side.

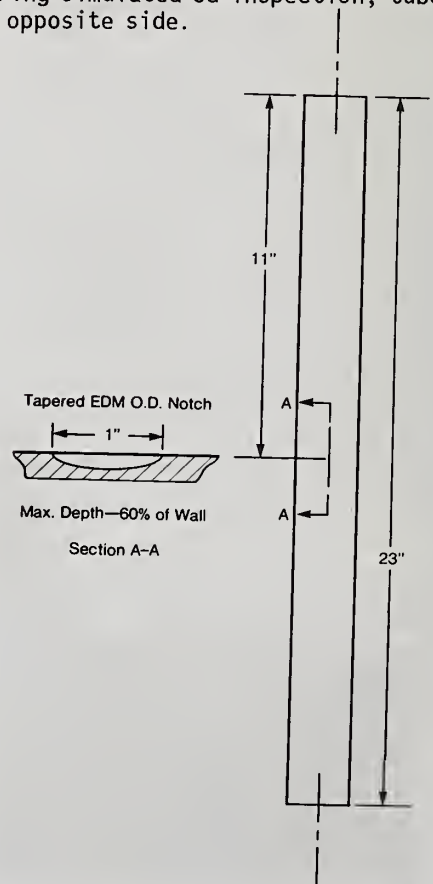

Figure 8. Typical configuration of axial notch specimen.



**Wastage Samples.** Samples representing wastage type defects were obtained by grinding metal from the outside surface to simulate large-volume wastage type flaws (low depth, large surface area). Compound wastage, which is a large-volume (low depth, large surface area) flaw, combined with a low-volume (large depth, small surface area) flaw, was also simulated in several specimens since this condition has been seen in service (fig. 9).

**Dented Samples.** The dented samples consisted of the following configurations:

**Minor dent.** These samples contained tubing with circumferential dents ranging in diametrical restriction from 0.002 to 0.005 inch. EDM notches of various depths and length and at various locations (center and edge of dent) were machined in these samples to study the capability of NDE for detecting and sizing flaws in the presence of dents. In all these specimens, a carbon steel sleeve, simulating a tube support, was placed over the dented section. Magnetite was also packed on the outside of the tube in the crevice between the dented tube and the tube support. Plastic end caps were glued to each end of the simulated tube support to retain the packed magnetite (figs. 10 and 11).

**Major dent.** These samples were similar to the minor dent specimens with the diametrical restrictions increased to 0.050 inch.

**Major dent with "ovalization".** The specimens listed in table 2 represent the dented tube configurations with the added complexity of diametrical "ovalization" in the region of the dent (figs. 12 and 13). Since the "ovalized" tube no longer permits simple slip on carbon steel tube supports, the dented regions in these samples were wrapped with slit sections of carbon steel (figs. 14 and 15). In these specimens, EDM notches

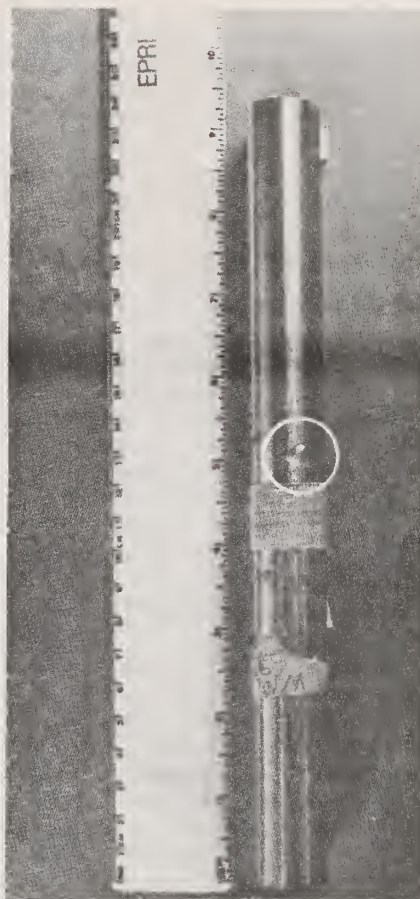

Figure 9. Specimen containing wastage defect.

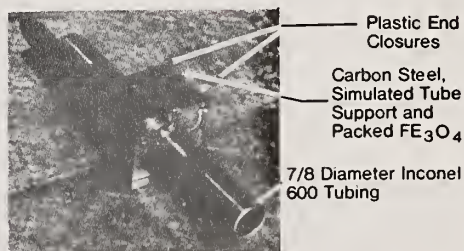

Figure 10. Dent specimen, supplied by BCL.

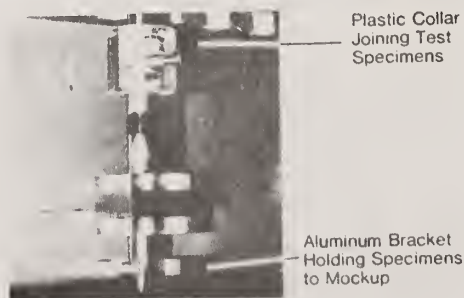

Figure 11. Dent specimen mounted in test block.

were placed at the beginning (one flaw), center (two flaws) and end (one flaw) of the dent section (figs. 13 and 14).

All of these samples were supplied by Zetec, Inc. Zetec also supplied a calibration standard of the type presently used in the nuclear industry.

Pitting. These specimens contained machined conical defects designed to simulate localized low volume pitting of various depths and at various locations.

Corrosion Samples. These samples contained laboratory-induced intergranular cracks to simulate the corrosion cracks occasionally reported in operating steam generators.

U-bend Samples. The U-bend samples contained defects all starting at the inside surface of the tubing. All defects were EDM notches, and these were located at the tangent and apex areas of the tube, at the introdose and extradose. To facilitate fabrication, the EDM notches in these samples were placed in the tubes before the tubes were bent to their final configuration. The inner rows of a series 51 SG were the only U-bends simulated since the sharp radius of curvature of the rows represented the most difficult access problems for U-tube inspection of this SG design. The outer rows of U-tubes, having a more gradual radius of curvature, were considered to represent an inspection situation similar to a straight section of tubing and were therefore not used in this study.

Tube Supports Drilled carbon steel plates were slipped over the Inconel tubing to simulate the influence of tube supports on the eddy current inspection (fig. 16). The influence of the tube sheet was not simulated in this study since problems in this area did not appear as severe as the defect situations described above. There was also insufficient detailed information regarding problems in the tube sheet area to allow simulation. If warranted, this area may be addressed in future studies.

Table 2. Dented and Ovalized Test Samples (Dimensions in Inches)

STO. NO.	DENT SIZE	O.D.				I. O.	
		SHOULDER		CENTER		CENTER	
		MINOR (A)	MAJOR (B)	MINOR (C)	MAJOR (D)	MINOR (E)	MAJOR (F)
1	0.010	0.624	1.069	0.618	1.047	0.500	0.937
2	0.010	0.744	0.989	0.724	0.968	0.620	0.862
3	0.010	0.859	0.891	0.039	0.871	0.735	0.766
4	0.015	0.634	1.063	0.618	1.031	0.500	0.921
5	0.015	0.754	0.981	0.724	0.951	0.620	0.845
6	0.015	0.359	0.891	0.839	0.851	0.735	0.747
7	0.020	0.644	1.057	0.673	1.015	0.500	0.905
8	0.020	0.764	0.973	0.724	0.933	0.620	0.828
9	0.020	0.975	0.875	0.839	0.839	0.735	0.735

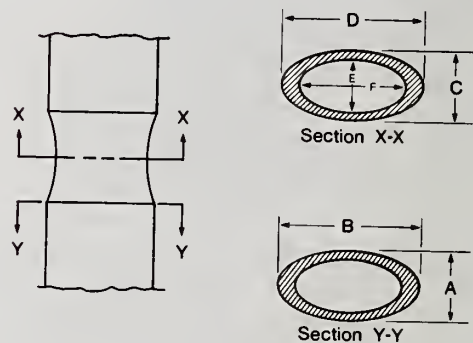

Figure 12. Configuration of dented and ovalized test samples.

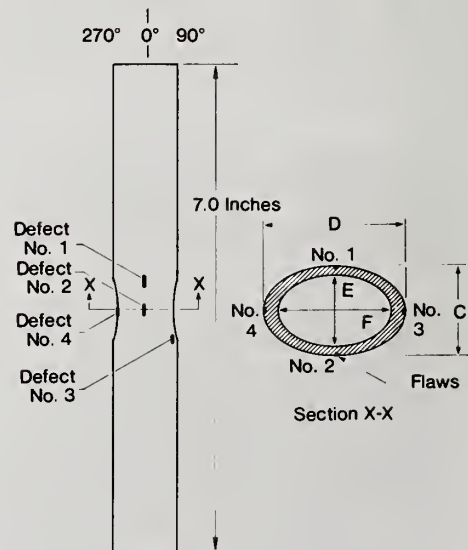

Figure 13. Location of defects in dented and ovalized test samples correlates with figure 12.



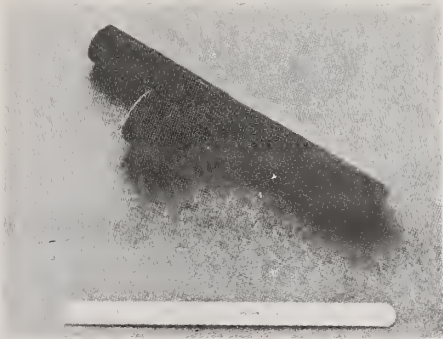

Figure 14. Tube specimen with ovalized dent and flaws, and split carbon steel simulated tube support.



Figure 15. Ovalized tube specimen with simulated tube support as tested.

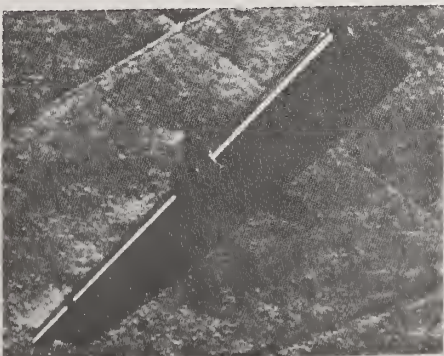

Figure 16. Tube specimen with slip-on simulated tube support.

### 3. Tests of the NDE Systems

The following three SG NDE systems were evaluated:

(1) Zetec Incorporated. The basic Zetec single frequency system represents present industry state-of-the-art equipment and techniques. The system uses a bobbin type differential coil inspection probe. The system is rugged and simple but is highly operator dependent. A prototype system using a rotating ET probe was also evaluated. Tests of these systems were performed at the Zetec laboratories in Issaquah, Washington.

(2) Holosonics/Intercontrole. This system represents state-of-the-art French field inspection technology and utilizes a multifrequency eddy current approach to improve detection and analysis of flaws in the presence of extraneous signals (tube supports, etc.). Final data analysis is manual. Other components of the system are also significantly different from present U.S. field equipment. This system was evaluated at the offices of Holosonics/Intercontrole, Richland, Washington.

(3) Battelle Northwest Laboratories. This is a multi-frequency system developed from EPRI funding. The system utilizes a modified Zetec ET probe combined with a instrumentation system that acquires four frequency data during inspection and automatically analyzes data from two of the frequencies to eliminate extraneous signals from probe wobble, tube supports, etc. This system was also evaluated at the Zetec laboratory in Issaquah, Washington. This system was in the prototype development stage and this study was the first evaluation of the system under simulated field inspection conditions.

Each of the above nondestructive testing systems was evaluated by the NDE panel in the following manner:

- (1) General Impressions. Prior to laboratory tests, details of the system were described by the system supplier.
- (2) Scan of Known Defects. The panel was allowed to review the system in operation and review such details as data analysis, etc.
- (3) Scan of Unknown Defects. Data were then taken using a mockup containing a series of simulated defective tubing.



(4) Summary of Results. Based on the results of 1, 2, and 3 above, each panel member submitted his conclusions to EPRI regarding the performance of the NDE system under evaluation.

A mockup containing examples of defective tubing was essential to conducting the study and was previously described.

In general, the tests associated with scanning the unknown defects progressed from simple straight tubing configurations to progressively more complex tubing and flaw geometries. Straight sections of tubing containing notches, pits, and wastage type flaws, and without tube supports, were tested first. Several of these tests were then repeated with tube supports added to the test specimens. These supports were located near, at the edge, and directly over the flaws. Placement was usually based on field experience with real flaws.

After the straight sections, the various U-bend configurations were tested. A typical test configuration is shown in figure 17. Following these tests, the systems were evaluated using dented tubing of various configurations. It should be noted that the Zetec rotating probe system was the only system capable of testing moderate or extensive dents or dents with an "ovalized" configuration. Zetec was also the only system possessing a probe capable of testing U-tubes after passing through a moderate or severe dent. For this reason, fewer tests were run on the other systems.

A number of tests were also conducted to study the influence of probe design, fill factor, test frequency, and gain on basic single frequency system performance.

The preliminary results of these tests are discussed in a later section.

#### 4. Data Analysis

A number of approaches can be taken to analyze the data. The method presented here is to consider two aspects of inspection system performance, the probability that a flaw of a specific through-wall penetration will be detected, and the accuracy of sizing through-wall penetration once a flaw is detected. These are the basic results available from existing eddy current inspection systems. Inferences from the inspectors, regarding the nature of the flaws, their length, and/or other

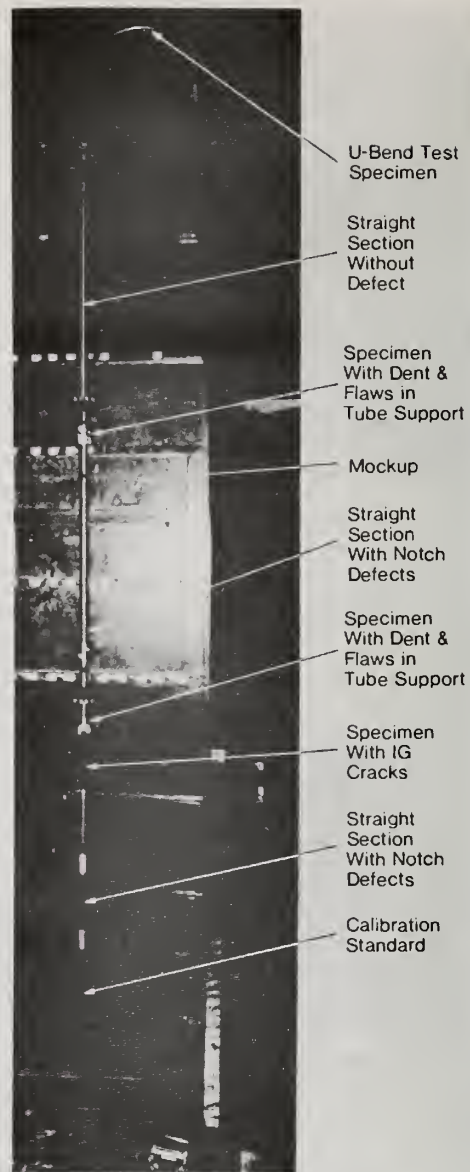

Figure 17. Typical test configuration.

aspects of flaw characteristics are not considered in this analysis. Also, the ratio of incorrect defect calls versus correct defect calls are not considered at this time. The probability of detecting a flaw, shown as the ordinate of the graph in figure 18 is simply the ratio of the number of defects reported divided by the total number of defects present in the specimen, i.e., probability of detection  $P_d$ , at specific defect depth is:

$$\frac{\text{flaws reported}}{\text{flaws scanned}} \times 100\%.$$

For the analysis of data in this study, correct defect detection required

the flaw to be reported in proper sequence and approximate location in the tube. In figure 18, probability of detection is plotted as a function of percent of through-wall flaw penetration, computed as the maximum depth of the flaw into the tubing wall divided by the total wall thickness.

Although the number of test samples per data point was in some cases relatively small, particularly when the defects are categorized by particular geometries (pits, notches, etc.), each system scanned similar defects approximately the same number of times. Resultant trends in relative system performance were therefore considered valid.

This points to one of the difficulties in establishing system performance curves for any one type of flaw geometry. If three data points are taken at each 10 percent defect depth, 30 data points are needed. When additional flaw geometries are added, or when more data points are desired, the resultant number of tests and required data analysis increases rapidly to the point where a one-week test program, as conducted for each system in this study, becomes impractical. Future studies of this nature must therefore consider improved methods of rapidly scanning and analyzing a large number of specimens in a relatively short period of time, or concentrate on a limited number of defect types.

The above analysis has one obvious drawback. By presenting detection probability as a function of percent of through-wall penetration, the influence of flaw volume upon inspection results is not readily apparent. In this case, a very narrow axial 60 percent through-wall flaw could produce the same detection probability as a 30 percent deep wastage type flaw covering a large volume of the tubing wall. Since both of these defects can have a different effect on tube integrity, the practice of reporting defect detection or sizing accuracy as a function of flaw depth alone could be misleading in judging the real performance of an NDE system for some applications. Although this is the major analysis approach followed at the present time, more comprehensive methods of judging inspection system performance are being considered and may be used in future analysis of data.

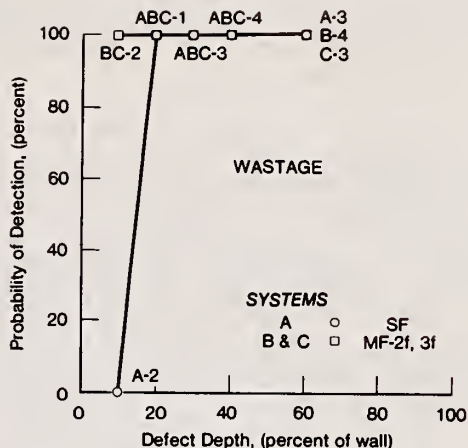

Figure 18. Systems A, B, and C detection of wastage.

In addition to detection probability, the flaw sizing capability of an NDE test needs to be determined. One approach is to show the mean error in percent of tube wall thickness with plus and minus two standard deviations, versus defect depth. This approach is being used to analyze the data in this program and the final results will be presented in future papers and in a special EPRI report.

Preliminary test results from evaluating the three systems are now considered in the next section.

## 5. Preliminary Results and Discussion

Analysis of the considerable test data generated in this study is incomplete at this time; however, the following preliminary results do indicate several interesting trends regarding defect detection under a variety of test conditions.

### 5.1 Wastage

Figure 18 indicates the detection performance of the three systems when used to inspect steam generator tubing for wastage-type defects. These flaws are in straight sections of the tubing and not in tube support or tube sheet areas. The systems referred to in figure 18 and all subsequent figures are:

System A - Zetec Inc., single frequency (SF), conventional push-pull drive unit, differential coil probe (set at code sensitivity for these tests)



System B - Holosonics/Intercontrole, multiple frequency (MF), conventional push-pull drive unit, differential coil probe

System C - Battelle Northwest Laboratories, multiple frequency (MF), conventional push-pull drive unit, differential coil probe.

On figures 18 and 19, the number after the system designation (A-3) indicates the number of independent tests conducted on a flaw of a specific defect depth. The data point presented in the figure is the average of the set.

Since the wastage defects present rather large volume flaws, the detection probability was expected to be good for all three systems, and it was. Detection performance does not drop until the defect depth drops below 20 percent of through-wall penetration for the single frequency system.

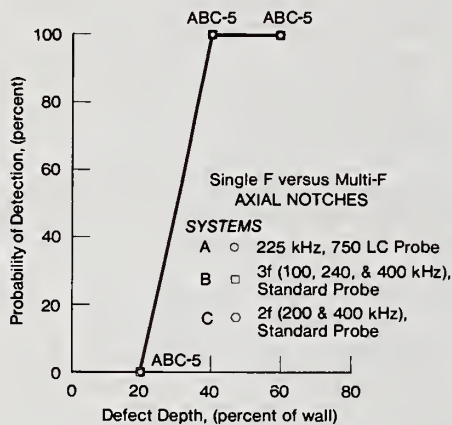

Figure 19. Maximum single frequency test sensitivity vs. standard multifrequency sensitivity for detection of axial notches.

Since the multifrequency<sup>3</sup> systems produce roughly twice the amount of inspection information and at two different test frequencies per flaw per inspection scan than does the single frequency (at 400 kHz), the detection probability is expected to be improved. As shown in the figure, the multifrequency systems do indicate a slightly improved detection capability for very small wastage flaws. It is difficult to ascertain system performance

differences since the single frequency results were also good. It is interesting to note that the multifrequency systems did not miss one wastage flaw in all the tests. Detection of wastage-type flaws represents one of the optimum uses of eddy current testing and its performance in this capacity has been very successful over the last several years in both commercial and military applications. The results of figure 18 are therefore not unexpected and tend to confirm the validity of the round robin test program.

## 5.2 Single Frequency Parameter Study

The sensitivity used by the single frequency system throughout the initial phase of this test program was established using ASME Section XI guidelines and is representative of existing ISI test sensitivity. It is important to remember that the single frequency results, presented previously, were not conducted at maximum equipment sensitivities. To investigate the full capability of the single frequency system, a special series of tests were conducted in which the effects of instrument sensitivity, inspection frequency and probe fill factor were considered. The probe fill factor is defined as the ratio of the diameter of the ET probe squared to the inside diameter of the tube squared.

A series of axial notches, 20, 40, and 60 percent deep, were scanned by the System A team members using various test parameters. These narrow axial notches (.005 in. width) are used to represent the crack-like flaws parallel to the tube axis. Although these flaws are perpendicular to the flow of eddy current in the tube and, therefore, in a favorable orientation for detection, they are very low volume defects and produce less response than a wastage-type flaw of equal depth. Since these defects are difficult to detect, they are ideal for system sensitivity studies.

After the above study, System A was retested against unknown defects using 225 kHz with a special probe having an outside diameter of 0.750 inches. For this series of tests, axial notches of 20, 40, and 60 percent were used. The test results are shown in figure 19.

<sup>3</sup>Multi-frequency in this sense refers to a simultaneous coil excitation as distinguished from sequential tests of a single frequency system at more than one frequency.



The two multi-frequency systems, i.e., Systems B and C, scanned the same series of notches used to establish the results in figure 19 and the subsequent probability of detection curves are also shown in figure 19. As shown, the detection probability for all three systems are identical. From this it appears that the single frequency system, if operated using the appropriate test conditions, can approach the detection capability of the multifrequency systems for axial notches in straight sections of tubing remote from tube supports.

Since past information indicates that flaw sizing accuracy falls with decreased frequency, simply dropping the test frequency of a single frequency test to increase flaw detection probability is not always the solution to improved overall inspection performance [5]. The type of flaw expected, sizing accuracy requirements, and field experience, must all be considered before the frequency and other test parameters are selected.

#### 6. Future Effort

Analysis of the considerable data generated in this study will continue. The first published report of the detailed results will be presented at the Second International Conference on Nondestructive Evaluation in the Nuclear Industry, February 13-15, 1978 (Session III, Problems Areas in NDE - Steam Generator, February 13, 1978).

As a follow-on to this study, EPRI has initiated the project RP1172, "Evaluation, Quantification, and Qualification of Steam Generator NDE Technology." This project will continue the SG NDE performance studies using an NDE evaluation panel and air transportable mockup. This 12-month project is expected to begin in December 1977.

---

This study would not have been possible without the excellent support of the following members of the NDE evaluation panel: A. Wehrmeister and H. Whaley, Babcock and Wilcox; S. Brown, Battelle Columbus Laboratories; J. Lareau, Southwest Research Institute; H. Houserman and A. Sagar, Westinghouse.

These panel members provided extensive support in the areas of program planning, test conduction, reduction and inter-

pretation of data, and analysis of system performance.

#### References

- [1] Van Rooyen, D., "PWR Steam Generator Tubing: Corrosion Problems," International Symposium on Application of Reliability Technology to Nuclear Power Plants, IAEA-SM-218/26, Vienna, Austria, October 10-14, 1977.
- [2] Steam generators to be replaced at Surry, Turkey Point Nuclear Units, *Nucleonics Week*, 18, [22] (June 2, 1977).
- [3] U.S. Atomic Energy Commission Regulatory Guide 1.83, "Inservice Inspection of Pressurized Water Reactor Steam Generator Tubes," June 1974.
- [4] Libby, H. L., An improved eddy current tubing test, Report No. HW-81780, GE/AEC contract No.-AT(45-1)-1350, Hanford Atomic Products Operation, Richland, Washington (May 7, 1964).
- [5] Sandona, E. and Denton, C. J., Eddy-current examination of Beznau steam generator tubing, in Nuclear Energy Maturity. (Pergamon Press, Oxford and New York, 1975) pp. 361-376.
- [6] EPRI project RP403, Multifrequency eddy current system for steam generator tubing inspection, Research and Development Projects, EPRI Report, 67 (May 5, 1977).
- [7] Beiers, T. S., Ivey, J. S., and Romey, W. M., "Phase I Report - Investigation of Parameters Influencing the Accuracy of Eddy Current Test Predictions for Nuclear Steam Generator Tubing O.D. Imperfections," MML-75-41, Report for Empire State Electric Energy Res. Corp. (Project No., EP4-2), July 18, 1975.
- [8] Becker, R. and Holler, P., "Results of the Application of the Eddy Current Testing with a Multifrequency Method," Paper No. 1b, Eighth World Conference on Nondestructive Testing, Cannes, France, Sept. 7, 1976.
- [9] Buchanan, R. A. and Talbot, T. F. "Analysis of the Nondestructive Examination of PVRC Plate-Weld Specimen 2512J." A Report for the PVRC Sub-

committee on Nondestructive Examination of Materials for Pressure Components, Pressure Vessel Research Committee, Welding Research Council, May 21, 1973.

- [10] Lockheed-Georgia Company, "Technical Manual, Nondestructive Inspection," AFLC program to Determine the Reliability of Nondestructive Inspection Under Actual Field and Depot Conditions, F41608-73-D-2850-0038, May 26, 1975.
- [11] Reinhart, E. R., "A Study of In-Service Ultrasonic Inspection Practice for BWR Piping Welds," EPRI Special Report, NO-436 SR, August 1977.
- [12] Flora J. H., and Brown, S. D., "Evaluation of the Eddy-Current Method of Inspection Steam Generator Tubing," Report No. BNL-NUREG-50512R, Battelle Columbus Laboratory/Brookhaven National Laboratory Contract No. EY-76-C-02-0016, September 30, 1976.
- [13] Weeks, J. R., Materials performance in operating pressurized water reactor steam generators, Nuclear Technology, 28, 348-355 (March 1976).
- [14] Fletcher W. D., and Malinowski, D. D., "Operating experience with Westinghouse steam generators," Nuclear Technology, 28, 356-373, (March 1976).
- [15] Hare, M. G., Steam generator tube failures: world experience in water-cooled nuclear power reactors in 1974, Nuclear Safety, 17, [2], 231-242 (March - April 1976).
- [16] Weeks, J. R., Corrosion of steam generator tubing in operating pressurized water reactors, in Corrosion Problems in Energy Conversion and Generation, C. S. Tedmon, Jr., ed., (The Electrochemical Society, Princeton, New Jersey 1974), pp. 322-345.
- [17] Birkle, A. J., PWR steam generator inservice inspections, in Third Conference on Periodic Inspection of Pressurized Components. (I Mech E Conference Publications 1976-10, London, England, September 20-22, 1976) pp. 61-65.

## Discussion

Question (Mr. Endler): Is carbon steel still being used in support plates?

Answer (Mr. Reinhardt): I think there are some vendors here. They might answer that, regarding their new designs.

Comment (Mr. Houserman): Some of those are being changed. There has been a lot of study, not only on the material, but the configurations.

Question (Mr. Mester): You mentioned multi-frequency equipment did not do as well in some areas, or did better in others. Was this the type of equipment that Hugo Libby was describing?

Answer (Mr. Reinhardt): We tested the Intercontrole pulsonic system from France. They came over and tested the mockup we had. That was a commercial system, what I call a field test system.

We tested the system that is being developed at Battelle Northwest which I consider, a development-type system. It is more refined in technology than the intercontrole system. It attempts to do automatic analysis which is rather significant.

The Intercontrole system relies heavily on a lot of manual analysis, but it has been in the field several times. So we had, a field-ready multi-frequency prototype system and we also tested a laboratory prototype multi-frequency system.

But our goals in testing the two systems were different. One, to see if the field system could be taken into the field, to solve some current problems. Our role in the Battelle system was to help direct their R&D in further development. This is the first time that they had really interfaced with the new problems, and these problems are new. That is one of the reasons we conducted the round robin for them. So there were different goals in the two programs.



## EDDY CURRENT TESTING IN GOVERNMENT

Patrick C. McElaney

U.S. Army Materials and Mechanics Research Center  
Arsenal Street  
Watertown, MA 02172

In preparing this presentation, the first reference I reviewed was AMC P 702-11, "Guide to Specifying NDT in Materiel Life Cycle Applications." This handbook is intended to serve as a guide to managers in incorporating NDT in the management of materiel at the different stages of the life cycle. The document serves as a basic reference to facilitate the planning, selection, and application of NDT for ensurance of satisfactory performance at reasonable cost. This document is currently being revised and will be submitted for DOD approval in the near future.

I turned to Chapter VI of the revised document (draft) and under "Electromagnetic (Eddy Current) Testing" found only ten ASTM documents referenced. Looking further, under "General," I found two documents which pertain to eddy currents: MIL-I-6870B Inspection Requirements, Non-destructive for Aircraft Materials and Parts; and Air Force T0-00-25-224, Welding High Pressure and Cryogenic Systems (Section 4). Subsequently, I found two other documents which should have been listed under Eddy Current Testing: MIL-T-15005E for 70-30 and 90-10 Copper Nickel Alloy Condenser and Heat Exchanger Tubing, July 1962; and T.O. IF-111A-36.

Proceeding, I reviewed the records of the Defense Conference on Nondestructive Testing, which originated in 1951 and will in a few weeks hold its 26th conference. I noted it was not until 1967 that they recognized eddy current testing as a significant method and appointed an EC consultant to assist in the solution of problems before the group. Prior to that, it had been included in a battery of other minor methods. There have been ten papers on eddy currents presented at the various sessions of the conference.

Several other indicators which I will not detail here demonstrate that the eddy

current method is not a major factor in the design and procurement stages of the government materials life cycle. Where the eddy current method is most important is during the service life of systems, i.e., in detecting defects that have arisen in service. The standards used in most cases are the parts themselves with artificial or natural defects. They are used to help define the condition of the parts and the end of service life so that the system can be withdrawn from service before failure.

The majority of papers presented at the Defense Conference dealt with maintainability (in-service) inspection. One, however, (S. Friedman, NSRDC - 1974) dealt with calibration standards and specifications for eddy current crack detection. He noted an increased use of eddy current instrumentation for the detection and characterization of cracks in structural weldments. He also reported an apparent dearth of adequate standards aimed explicitly at structural weld crack detection effectiveness. Mr. Friedman concluded that based on analysis of the experimental results, it would appear that current standards and practices in eddy current inspection for cracks in structural weldments are generally adequate. However, some easily implemented measures should be taken in order to ensure greater effectiveness without any increase in false alarm rate. These are:

1. Calibration blocks should conform as closely as possible to the metal under test in terms of electrical conductivity;
2. Instrument sensitivity should be checked on a relatively wide simulated crack in addition to checking it on a slit-saw cut or other, still tighter, simulated crack;



3. Instrument sensitivity should be set with an insulating shim between crack and coil to simulate maximum expected lift-off; and
4. Lift-off and instrument zero should be checked and reset, if necessary, on sound base metal structure prior to the inspection.

The shortcomings of calibration of eddy current OD tubing inspection systems by passing a tube containing fabricated flaws through the inspection coil was noted in MIL-T-15005E (Copper Nickel Alloy Tubing). It is difficult to obtain accurate and reproducible fabricated flaws in the reference tubing.

In recognition of this problem, the Naval Ships Engineering Center has sponsored a program at Battelle-Northwest to investigate alternate means of calibrating eddy current inspection systems applicable to 1 inch diameter, 0.070 inch wall copper-nickel tubing. Two alternate calibration approaches have been investigated:

1. the injection of reference signals into the electromagnetic field surrounding the eddy current inspection probe by means of special coils and electronically developed signals representing flaw conditions; and
2. the production of reference signals by translating specially prepared metallic tabs and electrically loaded coils past the eddy current inspection probe.

They concluded that artificially generated signal patterns provide an alternative to fabricated flaws for producing eddy current calibration signals. The signal injection and passive signal generation techniques described for OD tubing inspection can provide the variety of signal patterns necessary to confirm proper operation and calibration of the eddy current instrument under all anticipated inspection conditions. Signal injection techniques can duplicate actual flaw patterns, and passive loading coils or metallic tabs can closely simulate many typical flaw patterns. Signal injection coils can be incorporated into inspection coil assemblies to permit periodic recall

of calibration data during or between inspections.

Further, dynamic signal injection is particularly versatile in that virtually any signal pattern can be generated by properly programming the semiconductor memories. Once the memories are programmed, the information is stored indefinitely or until intentionally erased. Complete libraries of program data or memory devices can be accumulated to accommodate particular test conditions or test criteria, such as tube material, size, nominal wall thickness, and flaw types. The memories are easily duplicated with conventional PROM programmers at a small cost in comparison to fabrication of machined flaw standards.

In addition, metallic tabs and passive loading coils are also attractive alternatives to machined flaws. Metal tabs are easier to fabricate and less costly than machined flaws and can provide a good variety of signal patterns for calibration purposes. Loading coils and tabs can be mounted on nonmetallic forms to permit ease of handling and use. The signal pattern amplitude and phase angle control that is possible with loading coils using passive electrical components presents some interesting possibilities for switching arrangements to generate complete sets of calibration signal patterns. Neither tabs nor loading coils contain active circuitry or require reference signals from the test instrument which makes them more adaptable to a variety of instrument designs. This is in contrast to the signal injection circuitry which must be tailored to a specific instrument design, although the readjustments necessary to accommodate most instrument designs are relatively minor.

There are a few other points which I might briefly mention which are of considerable interest to the Government, although not strictly of interest at this time. Evolution of a defect characterization scheme for eddy current inspection has been impeded by the lack of an adequate model of the magnetic field defect interaction common to all the magnetic methods of nondestructive testing. The major accomplishment to date has been to show that the magnetic field/defect interaction can be modeled by finite element analysis techniques including material nonlinearities and complex defect geometries. It remains to verify the results experimentally and to examine the feasibility of

applying the modeling technique to include residual magnetism effects (for magnetic particle testing) and alternating current conditions (for eddy current testing).

One further point has come to my attention in the last several months. Some of my colleagues were preparing questions for the DARCOM Eddy Current Level III Certification, and in reviewing the many references, a plethora of terminology became readily apparent. As one might imagine, this creates much confusion. Although much of this is what you run into in physics texts, it was noted that some authors active in the eddy current field have their own unique terminology. It is hoped that those taking the exam have all read the appropriate reference material; if not, they are definitely in trouble.

#### Discussion

Question (Mr. Berger): You mentioned the biggest use of eddy current testing is related to in-service inspection problems in the field, and that the standards tend to be actual parts which are defective. Doesn't that make it very difficult to compare the calibration procedures of one maintenance depot with another?

Answer (Mr. McEleney): It doesn't help, but the results have been satisfactory.

Question (Mr. Berger): Does one person develop standards for the whole country?

Answer (Mr. McEleney): For example, government personnel examined the whole inventory of M-39, 20 mm gun tubes. There were mixed lots of improperly heat treated steels in the in-service pieces. These barrels were distributed all over the world, so they were examined in entirety, using good and bad barrels as standards. These standards were shipped around to various stations but all standards came out of one place, Watertown Arsenal. There are several other instances that are similar. Usually, there is one source of standards for a particular application.





## CURRENT STATUS AND FUTURE DIRECTIONS OF EDDY CURRENT INSTRUMENTATION

Tracy W. McFarlan

Ultrasonic & Electromagnetic Equipment  
Magnaflux Corporation  
Chicago, IL 60690

During the early 1950's, eddy current testing was introduced in this country to satisfy market requirements for a line of electronic instruments that could be used for surface crack detection, sorting of critical materials according to alloy content, hardness, geometry variations, and direct conductivity determinations. There was also a requirement for practical means of automatically testing parts at production line speeds with automatic readout of test results. Out of this emerged several vacuum tube instruments with limited frequency ranges utilizing meter, cathode ray tube, and recorder readouts, that were used for manual and automatic testing of critical components. These instruments were operated on 110 V lines, and they were considered portable if they could be carried around by one or two men. Operation required a skilled man who understood the basic principals of eddy current testing and electronics and had the ability to interpret test data.

ASTM established a subcommittee of E-7 to develop a glossary and to write recommended practice documents covering critical industrial applications, and ASNT provided good educational material in the first edition of the NDT handbook.

In the 1960's, solid state circuits became available in the electronics industry and this caused considerable changes in the methods of testing with eddy current equipment. The instruments were made much smaller and many of them could be powered with batteries. Operation of the instruments was simplified, automatic gates were developed, variable frequency operation over much larger ranges appeared, and readouts were improved considerably. Allied with these developments were greatly improved mechanical handling techniques that permitted reliable testing of materials of many different sizes and shapes at high speeds.

Today, the technology of eddy current testing has improved to such an extent that we can test ferrous tubing from the I. D., automatically test steel billets for longitudinal seams, detect corrosion between first and second members on aircraft structures, test wire at mill speeds, test rods at elevated temperatures, automatically sort large quantities of parts in automotive plants, find microscopic cracks on complicated shaped aircraft structures that cannot be found with other techniques, and accurately readout conductivity of materials in percent IACS.

Practical test specifications and recommended practice documents have been developed by several industrial companies, trade societies, and government agencies that provide good test guidelines for many critical applications. This work continues and, for the most part, these documents are abreast of events as they occur in the marketplace.

Personnel technical training facilities are available in many sections of our industry to educate people who are involved with eddy current testing from the operator in the field to the supervisor who is ultimately responsible for establishing set-up of the test and action based on test results.

As for the future, all of us can look into the crystal ball and see different things. It is apparent to us that the most important development must be the instrument's ultimate ability to make more and more decisions on its own. The instrument will have the ability of collecting sizeable quantities of test data, and, properly programmed, it should have the capability of digesting the data and making an accept/reject decision. Thus, pattern recognition, accurate mechanical control of the probe/coil with relationship to the test material,

storage of information and accurate calibration techniques will play an important part. The computer and microprocessor will have a considerable impact on future instruments' designs because of their control and decision-making capabilities. We anticipate that the instrument will have fewer controls, readouts will be much easier to interpret, and the mechanical portion of the system will become more sophisticated. Also, operation of the equipment at the extreme limits of the frequency range will lead to solutions of test problems that are unresolved today.

The future needs for improved eddy current testing in industry are numerous. Time permits mention of only a few here. Testing at elevated temperatures has always been a problem because of the difficult requirements for cooling the probe or coil. A breakthrough in terms of a new coolant or material used to make the detecting element, that will withstand high temperatures would be a big help. Precision mechanical devices that can accurately move the probe or part through the eddy current system to improve test results are badly needed. Calibration of the eddy current testing system in terms of actual testing conditions must be improved if we expect this method to become a more valuable and reliable test tool.

Calibration techniques that approach the actual test conditions are highly desirable. Of great importance is the improvement of test specifications and codes. Industry technical societies and some government agencies have done a commendable job to date. This work must continue with greater emphasis on the practical application of the eddy current system in the field.

#### Discussion

Comment (Mr. Moyer): No criticism intended, but you have your rose-colored glasses on when you say the suppliers will come up with our needs, especially when our needs are very specialized. You will come up with the needs that will guarantee Magnaflux or Magnetic Analysis or whoever is the designer, the maximum dollar. If we could guarantee to buy enough equipment, you would come up with that need.

Answer (Mr. McFarlan): In our company, after we have analyzed the marketplace needs, all of the economic factors that are involved, we make a return on invest-

ment calculation. If the ROI is satisfactory, we will design, produce and market standard instruments. Now what do we do with the instruments that are special? Or, what should we do with instrument requirements where there is not a big market; a production of five or ten instruments? To establish a product for this market is difficult. Economically, we cannot afford to develop a standard product line. Instead, we design something on special order. But the sales price will be higher than a standard product. This problem arises because most companies who have special requirements do not want to invest larger amounts in special equipment. So you negotiate back and forth. Sometimes companies will build their own equipment and other times they are willing to go ahead with the purchase of specialized types of equipment from the supplier.

Question (Mr. Brown): Do you think the microprocessor will make it possible to make fewer instruments that can be tailored in a wide variety of ways?

Answer (Mr. McFarlan): Absolutely, I think the microprocessors will find their way into the "manually operated instruments" area that we have been working with for crack detection. I can see microprocessors helping us to interpret data. Bob McMaster put his finger on it--interpretation is killing us. The microprocessor is going to be one of the ways of obtaining better interpretation.

Comment (Mr. Brown): You should consider the fact that you may be able to make one instrument for both eddy currents and ultrasonics.

Answer (Mr. McFarlan): Right, we can design a combination system.

Question (Mr. Taylor): I was just wondering whether you might make some predictions on what role the Bureau of Standards might play in the future?

Answer (Mr. McFarlan): The NBS Conductivity Program is excellent. There has been a dire need for the program for a long time. Beyond that program, if the government gets too involved in the area of NDT standards, it could represent a problem. I have talked to people about this, and it is something we ought to bring out and talk about.



In industry we have a competitive situation, and we like the idea of running our own show. This is typically American. There is fear in our minds that the government will get too involved. They are going to control the industry, distort the standards, and try and tell us how to do things.

The Bureau's contributions have been very good. They have worked well within that organization. If that is an example of how they are going to handle themselves in the future--great. We need them.

Comment (Dr. Green): I would like to make a comment. I know from my own experience in working with the National Bureau of Standards that everywhere they go they are viewed with awe and fear in the factories. People thought NBS was going to regulate them. That is the least of the Bureau's intent. I think that is the least intent from the present program. Of course, something develops and someone else takes over and the intent can change. You cannot guarantee that present policy will continue. I know at the present time, the Bureau does not plan on being a regulatory agency.

Answer (Mr. McFarlan): Another area we ought to talk about is the bill before Congress that nobody understands, that might involve NDT.

Comment: I do not know what bill it is.

Question (Mr. McFarlan): If you people know something about it and could enlighten us, please do so.

Answer: My last information was that bill was not coming out of committee.

Comment (Mr. McFarlan): I think we ought to know what it is and get some background on it. It is conceivable that if it dies in committee now, it may show up in the near future.

Comment: A comment on speciality systems. We are involved primarily in special systems as a supplier, not only instrumentation, but material handling equipment. Oftentimes, we will develop the proposal stages in very complicated highly engineered special systems, and we will go to, in our case, steel companies with all of this work. They will take the information, go out for bids on it, and give it to the low bidder.

This is the name of the game, and we know it. There is really not much we do about it. If Carpenter and Magnaflux could enter into working relationships for example, we are not spending a lot of money for nothing; more could be accomplished.

Comment: I think the bulk of us could do with very simple instrumentation. Now that we are developing complex dual systems, I am all for them. But, let us put some software in them so that a high school grad today can be trained to run it. I am not saying that is always necessary, but it should be true for the majority of tests.

Comment: I agree with an earlier comment about the willingness to invest large amounts of money to get something that will do the job. Unfortunately, too many people rely on market analysis relative to what the worth is of developing a new type of equipment for a new type of application. At the start when one or two people have an idea to go some place, the market does not look very big. I am sure Foerster did not know what his total market was, other than the fact he knew there were different applications. The problem is we sometimes defeat ourselves by market analysis. Once new equipment becomes available, it is amazing how much the market grows and becomes greater than people first visualized.

Question (Mr. Weismantel): There is a great need in microprocessors; is Magnaflux pursuing this area?

Answer: Yes. In the computer area I can tell you as of Monday of last week, we committed ourselves to an engineering program to get into computerized NDT. Yes, we are in it. We have recognized the possibilities for some time, but the opportunity was not right, the timing was not right until now. Now, we think it is right. Look at the trade shows and see what is happening, the ASNT show in Detroit. It is quite obvious what is happening. Computerized systems were there. That kind of activity spurs us on and motivates people to act.

Question (Mr. Berger): I find the economics discussion interesting, certainly a driving factor; but I would like to get to some other aspects of the instrumentation problem. Our problem is measuring certain characteristics of the instrumentation. We had a meeting on



ultrasonics here a few weeks ago, as you know, and one of the points made was that there would be no attempt by anybody to standardize how everybody's pulser should work, but there should be agreement on how to measure those pulses in terms of rise time, shape, whatever. Are there similar problems in regard to eddy current instrumentation?

Answer (Mr. Hentschel): First, one would have to clean up the terminology. Everybody uses terminology that is diverse.

Question (Mr. Berger): You are saying terminology is now in such a bad state that we cannot agree?

Answer (Mr. Hentschel): Yes. The terminology has to be agreed upon.

Comment (Dr. McMaster): May I comment on that? Twenty years ago when we brought out the first edition of the handbook, we were voted down by two-thirds of every group and they said the terminology was obscure, too theoretical, and too impractical to ever make it in the field. It is better to make the word probe coil standard. The handbook terminology should not be frozen but, should in a paragraph say, probe coil, and then give seven other different ways to describe the same thing by inference. Then, regardless of what literature a person reads ten years in the future, there is a chance he will be able to recognize the words. I detest frozen words of the type you need to have in specifications.

Comment (Mr. Brown): I hate to disagree, but there are some words like sensitivity, resolution, phase angle, that are things to be measured with numbers; and they should have generally agreed-upon definitions. We are way behind in this field. And, when we get them, it will be interesting to see what they describe.

Comment (Mr. Richardson): I would like to comment. I believe the only thing you can describe is the linearity of the response of the instrument. You can do that with signal injection.

Comment: I am in the business of providing inspection services to the nuclear industry. It would appear that NBS is developing instruments that are going to measure conductivity, that is all right, you should have some conductivity standards to verify the performance of tests. In the business of testing tubing

for flaws, there are problems. Standardizing the sorts of things we are talking about is going to create more problems for industry than it is going to solve. Maybe because it is my business and I am particularly sensitive to it, but I am running up against ASME codes, the NRC, etc. It is a fact of industry. We are meeting paperwork requirements. And even though we have a better test, a more rapid test that gives more results, if it does not meet these paperwork requirements, it is not accepted. The standardization of these kinds of documentation hinders what we are all trying to do.

As an example, consider the ASME code followed by the nuclear industry. By the time something technical has been developed and is accepted, published, and accepted by NRC, there is a period of about seven years. I do not want to see us put in this position by NBS. In seven years trying to live up to standards we set today, we have got to be very careful of what we are documenting.

Question (Mr. Berger): I think you are right. I do not have any problem with that. I go back to what I said at the beginning of the meeting. The kind of standards or procedures we really like to develop, beyond the conductivity measurements, are those that contribute somehow to better reliability or better measurements, or better assurance that what you are measuring is there. It could be various aspects of the instrumentation are not important, and measurements of the coil may not be important to a particular objective. But, are there measurements, calibration procedures, whatever, that can be made in the eddy current field which would be helpful? For example, the ultrasonic test blocks, is there anything comparable in the eddy current field?

Answer (Mr. Denton): Right now, we have what we call a master standard and we have a mag tape on that standard, so we make ten more standards. Right now the standards are traceable to my desk or your desk. If it is traceable to NBS, it is a lot more acceptable.

Comment: One problem we have is sorting steel, grades of steel, due to slight changes in chemistry, heat treats, various things. If you could come up with some sort of standard or some measurement, whether it is permeability, saturation effects, whatever, to help us

sort grades of steel, bar stock, plate stock, Bethlehem, J & L, etc., which was made today or in the middle of the winter.

Comment (Mr. Wehrmeister): To set a little parallel when you measure conductivity, as in sorting, you are looking for a quantitative number to describe what you are measuring. The standard that developed through the years is a standard of what it is you are measuring, regardless of what instrument you use, so you can calibrate it to the standard. This is where you have to draw the line. When you get defect detection, cracks, things of that sort to use parallel structure, you would be standardizing cracks. And, I have not found one yet. I think that is where it ends. Standards end with flaw detection, but it begins in sorting applications.

Comment (Mr. Brown): I know Mr. Denton makes good standards. But there is a good probability he makes them the same way each time. What if somebody at the other end of the country looks at the boiler code and starts making standards? How will they compare with the records in your desk drawer? I have an uneasy feeling about holes drilled at different speeds, different temperatures, voltages, etc. I think you could do a lot of good by surveying the range of variation that exists due to different techniques of making holes. Do it over a wide variety of conditions, fast, slow, EDM. Then the areas in which standardization is needed might be clearer.

Comment (Mr. Berger): We have done something very similar with ultrasonic reference blocks by borrowing all the types of blocks we could find. The variation was found to be about 40 percent. At least, we know what the number is.





## MULTIFREQUENCY EDDY CURRENT INSPECTION TECHNIQUES

Hugo L. Libby

2302 Frankfort Street  
Richland, WA 99352

### 1. Introduction

Eddy current nondestructive testing methods are electromagnetic field methods in which eddy currents are induced in the test specimen by alternating currents flowing in inspecting coils adjacent to or surrounding the test specimen. Test specimen conditions are monitored by measuring the impedances of the test coils (or currents and voltages of the coils) as they are affected by eddy current flow within the specimen. The methods have been quite highly developed and they are used widely in the metals industry for the inspection of electrically conducting materials and parts [1]<sup>1</sup>.

Most eddy current inspections are made using single frequency excitation, with the equipment permitting a selection of any one of several different frequencies. However, it has been found that use of two or more test frequencies simultaneously, resulting in a large number of degrees of freedom in the signal, can give a larger amount of information about the test specimen than can be obtained using a single frequency [2,3,4,5]. Other workers are active in multifrequency eddy current applications, but publications are difficult to find. Halmshaw [6] in an article on potential developments in non-destructive testing mentions work of R. Becker and P. Holler in Germany and refers to various papers on the subject presented in Session III of the 7th International NDT Conference in Warsaw in 1973 and at the NDT Materials Conference at Nijmegen in 1974.

A multifrequency eddy current tube inspection system has been developed by Intercontrole, Gif-sur-Yvette, France, but the writer has found no technical articles describing this work.

Significant work in the multifrequency eddy current techniques has been done by Mr. Bob Meister and the staff at Battelle Columbus [7] using a different approach than that reported in the body of this paper. Their approach, a post-analysis procedure, uses an eddy current system designed around a PDP 11/40 mini-computer and involves nonlinear transformation of measurements, application of the transformed measurements to a decision algorithm, and the display of results.

In contrast, the technique described in the body of this paper is a real time method. Much of this paper is based upon work performed by Battelle Northwest [8] sponsored by the Electric Power Research Institute.

Important aspects of the eddy current inspection method are design and construction of the eddy current inspection coils, handling or transporting of the test specimens, selection of test frequency or frequencies, adjustment of instrument sensitivity, selection and use of test calibration specimens or standards, choice of signal filtering means, test specimen speed of translation, setting of any automatic alarm indicators, and interpretation of test data when required.

Especially important in the design of eddy current inspection systems is the size, shape, and configuration of the inspection coils and the selection of inspection frequencies. Of the essence here are the flow patterns of the eddy currents which are affected by the factors mentioned, as well as by the presence of irregularities within the test specimens which affect the electromagnetic properties of the specimens.

<sup>1</sup>Figures in brackets indicate literature references at the end of this paper.

The electromagnetic skin effect is important in any eddy current system and especially so in the multifrequency method. It is the variation of the skin effect with frequency and the resulting differences in the flow pattern of eddy currents that make it possible for the multifrequency method to produce more information about the test specimen than does the single frequency method [4].

## 2. Multifrequency Eddy Current Principles

Significant multifrequency eddy current inspection principles are:

a. Two or more excitation frequencies are applied simultaneously to the inspection coil assembly.

b. The filtered, demodulated outputs representing the response of the system to the different excitation carrier signals can carry independent information as a result of the eddy current skin effect which varies with frequency.

c. The principles of superposition apply to the effects of the excitation currents for inspection coils adjacent to nonmagnetic (nonferrous) test specimens.

d. The principles of small signal analysis are usually applied in idealized analyses because of the resulting simplifications.

e. The inspection of magnetic test specimens is beyond the scope of the present discussion because of extreme nonlinear effects.

The principles of the multifrequency (multiparameter) method of eddy current inspection have been described [3,4] from three viewpoints:

a. Generalization of the single frequency phase discrimination technique.

b. Algebraic solution of a set of simultaneous equations.

c. Geometrical approach involving vectors and signal space.

The interrelationships and common basis of these three viewpoints will become apparent as the discussion proceeds.

## 2.1 Single frequency method

A single frequency eddy current inspection device is depicted in figure 1. The single frequency generator A

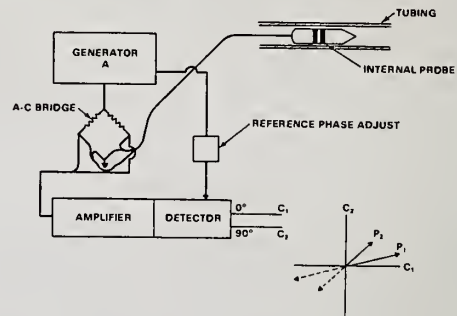

Figure 1. Single frequency eddy current tubing inspection device.

supplies excitation currents to the differential internal eddy current probe coils. The amplified bridge output signal is applied to an amplitude-phase detector which produces demodulated in-phase ( $0^\circ$ ) and quadrature-phase ( $90^\circ$ ) signal outputs  $C_1$  and  $C_2$ , respectively. Two signals are shown in the output signal plane  $C_1$  versus  $C_2$  caused as the inspection probe assembly is caused to transverse past two hypothetical defects  $p_1$  and  $p_2$  in sequence. Null bridge balance conditions are assumed except when the probe coils are near the defects. It is also assumed that small signal conditions exist and that the Lissajous figures formed are straight lines in the  $C_1$  versus  $C_2$  signal plane.

The following equations can be written to describe the two signals  $C_1$  and  $C_2$  when parameters  $p_1$  and  $p_2$  appear at different times:

$$a_{11}p_1 = C_1 \quad (1)$$

$$a_{21}p_1 = C_2 \quad (2)$$

$$a_{12}p_2 = C_1 \quad (3)$$

$$a_{22}p_2 = C_2 \quad (4)$$

where  $C_1$  and  $C_2$  can vary as  $p_1$  and  $p_2$  fluctuate. The coefficients  $a_{11}$ ,  $a_{21}$ ,  $a_{12}$ , and  $a_{22}$  are constants associated with the inspection coil system, test specimen, and general electronic signal circuits of the instrument.



Equations (1) and (2) are written assuming parameter  $p_2$  is zero. Similarly, parameter  $p_1$  is zero for eqs. (3) and (4). Now, assuming that the principles of linear algebra apply, a consequence of the small signal assumption, we can combine these equations into two equations as follows:

$$a_{11}p_1 + a_{12}p_2 = C_1 \quad (5)$$

$$a_{21}p_1 + a_{22}p_2 = C_2. \quad (6)$$

This system of two simultaneous equations has two variables or parameters  $p_1$  and  $p_2$ . The values of the coefficients  $a_{11}$ , . . .  $a_{22}$  can be determined by varying  $p_1$  and  $p_2$  individually and measuring their effect upon the values of  $C_1$  and  $C_2$ , which can be observed. Equations (5) and (6) can be expressed in matrix form as

$$[A] P = C \quad (7)$$

where

$$[A] = \begin{bmatrix} a_{11} & a_{12} \\ a_{21} & a_{22} \end{bmatrix}, \quad (8)$$

$$P = \begin{bmatrix} p_1 \\ p_2 \end{bmatrix} \quad (9)$$

and

$$C = \begin{bmatrix} c_1 \\ c_2 \end{bmatrix} \quad (10)$$

The matrix  $[A]$  is considered to be a modulation relating the test specimen parameter  $P$  to the demodulated output signal  $C$ . Excitation amplitude and relative phase, amplifier gain and instrument phase shifts are assumed to remain constant. The system of two equations, with known values of the coefficients  $a_{ij}$  and the quantities  $c_1$  and  $c_2$ , can be solved for variables  $p_1$  and  $p_2$ . A third signal caused by a third variable cannot be accommodated in this system of equations, as it could be expressed as a linear combination of the two existing signals and thus is not independent. The output of the single frequency system thusly can be analyzed to yield only two variables or parameters.

## 2.2 Multifrequency theory

It has been shown in a previous paper [3] that the required independence of signals may be obtained by adding excitation frequencies and analyzing circuits. Simple theory indicates that for each additional frequency applied, two additional variables may be solved. However, more advanced signal theory indicates that, assuming the test specimen variables signal effects are of the minimum phase type, the number of additional variables accommodated will approach one per additional frequency as the number of frequencies are increased.

Assuming that we are considering a modest number of excitation frequencies, the eq. (7) which was developed for a single frequency system can now be generalized to handle additional frequencies by simply increasing the number of rows and columns in  $[A]$  and the number of rows in  $P$  and  $C$ .

The equation system in the form of eqs. (5) and (6) may be solved using the rules of algebra. The matrix equation

$$[A] P = C \quad (7)$$

may be solved using the rules of matrix algebra:

$$P = [A]^{-1} C \quad (11)$$

where  $[A]^{-1}$  is the inverse of  $[A]$ .

The phase discrimination technique is used widely in the single frequency system to discriminate against a single variable signal such as the one caused by  $p_2$  in figure 1 by rotating the signal pattern by varying the reference phase adjustment until the signal lies along the  $C_1$  axis. In this position, it has no component in the  $C_2$  axis direction (line  $C_1$ ). Similarly, the parameter or variable  $p_1$  can be discriminated against by rotating the pattern so that its signal has no component in the  $C_2$  direction. It is noted that with the circuit shown the two parameters cannot be separated at the same time. This limitation is not one of principle, and can be overcome by the use of additional circuits. Also, this limitation is not inherent in eqs. (5), (6), (7), and (11).

The foregoing concepts are exemplified and expanded in the diagram in figure 2. The inspection coil assembly is



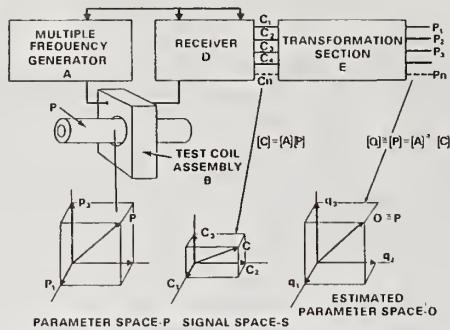

Figure 2. Multifrequency concept.

excited by a multiple frequency generator, and the receiver has several amplitude-phase detectors whose outputs are  $C_1$ . . .  $C_n$ . This is followed by a transformation section which performs the inverse function indicated by eq. (11). Figure 2 also applies the signal theory concepts of parameter space, signal space, and estimated parameter space to the eddy current problem.

In the application of these concepts in a practical instrument, the circuits within the transformation section can be adjusted manually to produce the required parameter separating function. In the foregoing discussion, the need to instrument the inverse of  $[A]$  is inferred. In fact, it is only necessary to instrument adjoint  $[A]$  as it is the adjoint which contains the variable separating capability or decoupling capability. This is stated algebraically as:

$$[A]^{-1} = \frac{\text{Adjoint } [A]}{|A|} = \frac{\text{adj } [A]}{|A|} \quad (12)$$

where  $|A|$  is the determinant of  $[A]$ .

It is noted that  $|A|$  is simply an amplitude factor. In a practical example, it is often desired to adjust the output amplitudes at  $p_1$ . . .  $p_n$  individually.

### 2.3 Multifrequency eddy current device.

A multifrequency eddy current inspection device is shown by the block diagram in figure 3. It is shown to emphasize the nature of a two-frequency system, but the extension in principle to a greater number of frequencies is shown by the dotted lines. The diagram has been drawn to emphasize that the signal outputs

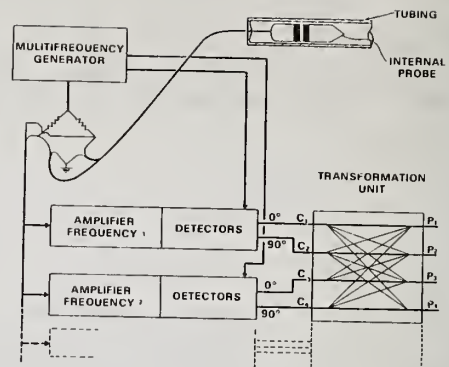

Figure 3. Multifrequency eddy current tubing inspection device.

$C_1$  to  $C_4$  of the receiver-detector system can be considered to have come from two receivers, each operating at a different frequency. The output of the first is  $C_1$  and  $C_2$ , and the output of the second is  $C_3$  and  $C_4$ .

The transformation unit or section can have any one of many different forms. The one shown here in a line diagram is a direct instrumentation of the adjoint of the matrix  $[A]$  previously discussed. The line diagram indicates that each output  $p_i$  is in general supplied by some combination of the inputs  $C_j$ . Provision must be made to sum these input quantities in various amounts of either sign including the null quantity. The requirement here for separation of variables is that the summing circuits feeding any  $p_i$  output line be adjusted so that the effect of all the remaining variables be discriminated against at that particular output line.

Thus, in the example shown for four variables, the summing circuits feeding output line  $p_1$  must be adjusted so that the effect of variables  $p_2$ ,  $p_3$ , and  $p_4$  are eliminated at output line  $p_1$ . Similarly, the summing circuits feeding output line  $p_2$  must be adjusted so that the effects of variables  $p_1$ ,  $p_3$ , and  $p_4$  are minimized at output line  $p_2$  and in a likewise manner for the remaining lines. Reaching the desired adjustments is difficult as it is desirable to present to the inspection coil assembly the several specific variables, whose effects are to be minimized, in sequence for convenience in each case.

It is emphasized that a fifth independent variable or parameter cannot be separated using this four-parameter system. The system must be expanded by adding another excitation frequency, a receiver channel, and additional transformer circuits to accommodate an additional parameter.

### 2.4 Transformation circuits

Two other forms of transformation sections are shown in the next two figures. Figure 4 shows one based upon

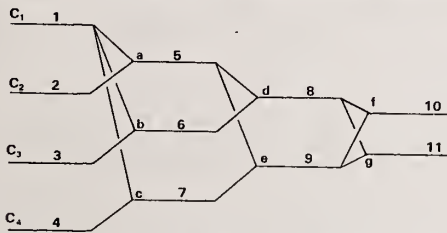

Figure 4. Parameter discrimination or transformation section.

the method of Gauss for eliminating one variable at a time [3]. This particular circuit can discriminate against signals caused by two variables ( $p_1$  and  $p_2$ ) and has two readout channels, one for  $p_3$  and one for  $p_4$ . This circuit, in contrast to the more general arrangement of the transformation circuit in figure 3, may require interchanging of the input leads depending upon the distribution of signal components between the leads. This need for increased flexibility arises because the laws of linear algebra must be satisfied. In operation the circuit is adjusted (calibrated) to perform the desired discrimination between signals. The circuit in figure 4 is a four-parameter circuit and has the capability of discriminating against two parameters and of separating signals from two other parameters at the two output channels 10 and 11. The signals caused by the first parameter  $p_1$  are minimized on lines 5, 6, and 7 by adjusting in sequence the summing circuits at summing junctions a, b, and c, while the signals caused by  $p_1$  are being applied to the inputs at lines 1, 2, 3, and 4. Next, a second parameter (perhaps some probe variable signal residue remaining on lines 5, 6, and 7) can be minimized on lines 8 and 9 by adjusting the summing circuits at d and e. The inspection probe is now caused to traverse past two selected defects, one representing outer wall defects, and one represent-

ing inner wall defects, and summing circuits adjusted at f and g to give optimum separation of the respective signals at lines 10 and 11.

The circuit shown in figure 5 uses Cartesian coordinate transformation devices to perform the summing functions [9]. The first parameter is discriminated against following the same procedure as described in figure 4, except that rotation of the signal pattern rotator's shafts ( $\phi_1$ ,  $\phi_2$ , and  $\phi_3$ ) are adjusted instead of potentiometers. Rotators  $\phi_4$  and  $\phi_5$  are next adjusted to minimize signals on lines 8 and 9 caused by two other parameters. Next,  $\phi_6$  is adjusted to minimize signals caused by the fourth parameter on line 11. Although the calibration (adjustment) of the rotators for optimizing the discrimination between variables is usually done experimentally by the operator, the explanation of their function can be clarified by following signals through the circuit by an analytical method. This is done in the next section. As an introduction to the analytical approach, the equations describing the operation of the rotator transformation unit are now given.

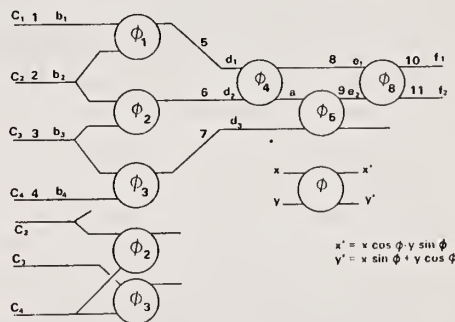

Figure 5. Parameter discrimination section using plural transformation rotars.

The transformation equations for the transformation rotators shown in figure 5 are:

$$x' = x \cos \phi - y \sin \phi \quad (13)$$

$$y' = x \sin \phi + y \cos \phi \quad (14)$$

where  $x$  and  $y$  are the two signal inputs and  $x'$  and  $y'$  are the signal outputs, and  $\phi$  is the mechanical angle of the rotator. Equations (13) and (14) are related to those used in analytic geometry to describe transformation of Cartesian coordi-



nates. However, eqs. (13) and (14) differ slightly in that they have been modified to describe the transformation of signals flowing through the circuits rather than the rotation of coordinates. Given a vector input signal with components  $x$  and  $y$ , the shaft angle  $\phi$  which will produce a null (or near null) signal at the output  $x'$  is obtained by equating the right hand side of eq. (13) to zero and solving for  $\phi$ :

$$x \cos \phi - y \sin \phi = 0$$

$$\frac{\sin \phi}{\cos \phi} = \frac{x}{y} = \tan \phi \quad (15)$$

$$\phi = \tan^{-1} \frac{x}{y} \quad (16)$$

Equation (16) can be applied sequentially to rotators, 1, 2, and 3 in figure 5 to determine the values of  $\phi_1$ ,  $\phi_2$ , and  $\phi_3$  to minimize the effect of the first variable on the signals  $d_1$ ,  $d_2$ , and  $d_3$  on lines 5, 6, and 7. Next, eqs. (13), (14), and (16) can be used to determine the values of  $\phi_4$  and  $\phi_5$  to discriminate against two more variables. These two variables produce signals which may occupy a two-dimensional subspace of the main four-dimensional signal space which applies in this example. When  $\phi_1$ ,  $\phi_2$ , and  $\phi_3$  are determined, the signals  $d_1$ ,  $d_2$ , and  $d_3$  can be found for any input signals to rotators  $\phi_1$ ,  $\phi_2$ , and  $\phi_3$ .

The signal at  $e_1$  is

$$e_1 = d_1 \cos \phi_4 + d_2 \sin \phi_4 \quad (17)$$

and to minimize the signal at  $e_1$  for a specific input signal  $S$  (in the two-dimensional subspace) which has components  $d_1$ ,  $d_2$ , and  $d_3$ , we find from eq. (16):

$$\phi_4 = \tan^{-1} \frac{d_1}{d_2} \quad (18)$$

The signal at line  $a$  is, from eq. (14):

$$a = d_1 \sin \phi_4 + d_2 \cos \phi_4 \quad (19)$$

The output signal at  $e_2$  is

$$e_2 = (d_1 \sin \phi_4 + d_2 \cos \phi_4) \cos \phi_5 - d_3 \sin \phi_5 \quad (20)$$

We find the value of  $\phi_5$  to give a null or near null output  $e_2$  for selected signal  $S$  in the two-dimensional subspace by equating  $e_2 = 0$  in eq. (20) and determine that

$$\frac{(d_1 \sin \phi_4 + d_2 \cos \phi_4)}{d_3} = \frac{\sin \phi_5}{\cos \phi_5} = \tan \phi_5 \quad (21)$$

or

$$\phi_5 = \tan^{-1} \frac{d_1 \sin \phi_4 + d_2 \cos \phi_4}{d_3} \quad (22)$$

Finally, the output of lines 10 and 11 can be obtained by another application of eqs. (13) and (14). The value of  $\phi_6$  required to suppress the signals at the output line 11 caused by signals occupying the two-dimensional subspace is determined by application of eq. (16):

$$\phi_6 = \tan^{-1} \left( \frac{e_1}{e_2} \right)_{S_{pq}} \quad (23)$$

When the rotator  $\phi_6$  is set at the value of  $\phi$  given in eq. (23), the variable or parameter can be observed (when present) on line 11 (signal  $f_2$ ). In addition, under the proper input signal conditions, other signals not discriminated against will also give indications at line 11. Results of the signals caused by the three variables discriminated against will also be observed at line 11. Amplitudes of these residues depend upon the success of the discrimination adjustments.

### 3. Application of the Theory - Four-Parameter Example

The application of the foregoing principles is illustrated in this section by a combined approach using eddy current instrument measurements of the responses to fabricated tubing flaws and analyses showing the projected performance of a transformation section with these responses as inputs. The following four-parameter example illustrates the application of the multifrequency principles described in the foregoing section.



### 3.1 Data acquisition

This example uses signal data scaled from Lissajous patterns obtained using a test specimen of Inconel 600, 7/8 in. diameter steam generator tubing containing fabricated calibration holes. The wall thickness  $T$  is approximately 0.050 in. (1.27 mm). The calibration regions and other conditions used in this report are:

- one 100 percent  $T$  drilled hole, 0.067 in. (1.7 mm) diameter ( $T$  equals wall thickness)
- one 80 percent  $T$  drilled hole, 0.078 in. (1.98 mm) diameter
- four 20 percent  $T$  drilled holes, 0.1875 in. (4.76 mm) diameter spaced at 90 degree intervals around the circumference of the tube
- a simulated tube support made of mild steel 3/4 in. thick surrounding the tube.

Lissajous figures were generated for these tube inspection conditions using the equipment arrangement shown in figure 6. (Signals observed of other calibration holes in this tube section were present, but results are not presented here in the interest of brevity.) The equipment comprised: (1) a two-frequency laboratory eddy current system with a differentially connected internal inspection coil probe operating simultaneously at 100 kHz and 300 kHz; (2) a multiplexing electronic switch; and (3) a cathode ray oscilloscope. The in-phase ( $0^\circ$ ) and quadrature ( $90^\circ$ ) demodulated (detected) outputs of the two carrier frequencies, 100 kHz and 300 kHz, were applied to the multiplexing switch. The purpose of the multiplexer is to time-multiplex the four output signal channels of the detectors so that two Lissajous patterns, one from each of the two carrier frequencies, could be displayed nearly simultaneously on the cathode ray oscilloscope screen. Dwell times of the electronic switches were about 2.5 ms, and the repetition rate was about 10 ms, giving a display rate of about 100 points per second for each Lissajous pattern.

The measurement system used is equivalent to that of two single frequency inspection devices, one operating at

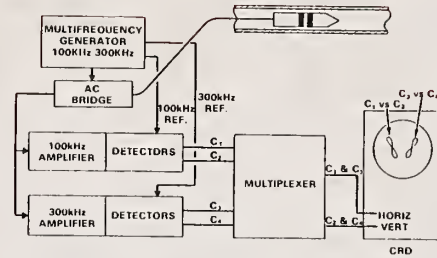

Figure 6. Equipment for obtaining data for algebraic solution of two-frequency inspection method.

100 kHz having detector outputs  $C_1$  and  $C_2$ , and one operating at 300 kHz having detector outputs  $C_3$  and  $C_4$ .

The patterns obtained by displaying  $C_1$  versus  $C_2$ , and  $C_3$  versus  $C_4$  by use of the multiplexer were separated on the oscilloscope screen by adjustment of dc offset controls in the respective detector circuits.

Tracings of several specific points on the Lissajous pattern photographs for several inspection conditions are shown in figure 7. Signal components for these conditions as scaled from the photographs are given in table 1.

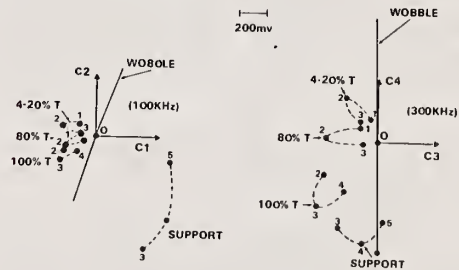

Figure 7. Signal loci for five test conditions at 100 kHz and 300 kHz obtained with multiplex system.

### 3.2 Objectives of calculations

The functioning of the transformation unit will be shown by using the measured instrument outputs as inputs to the transformation unit and by calculating the settings of the rotators and the resulting signals in the transformation section. More specifically, we desire to calculate:

Table 1. Components of Signals in Figure 7.

Existing Condition	Signal Symbol	Relative Signals at Detector Output			
		$C_1$ ( $b_1$ )	$C_2$ ( $b_2$ )	$C_3$ ( $b_3$ )	$C_4$ ( $b_4$ )
Probe wobble	$S_{12}$	17.9	48.3	- 6.0	229.8
Support	$S_{23}$	358.7	-793.3	-262.6	-607.6
	$S_{24}$	521.1	-576.0	-112.8	-715.7
	$S_{25}$	513.9	-179.7	50.7	-564.7
100% T hole	$S_{32}$	-227.6	-101.9	-380.6	-231.1
	$S_{33}$	-246.4	-166.0	-425.3	-449.0
	$S_{34}$	-134.0	-128.0	-236.8	-353.1
80% T hole	$S_{41}$	- 97.4	19.8	-116.0	100.0
	$S_{42}$	-202.3	- 41.4	-367.5	30.3
	$S_{43}$	- 87.2	- 33.0	- 98.9	- 13.5
4-20% T 4 holes	$S_{61}$	-110.0	90.5	- 42.3	164.8
	$S_{62}$	-232.0	79.1	-218.8	314.0
	$S_{63}$	-111.2	27.6	-121.4	155.3

a. The settings of rotators,  $\phi_1$ ,  $\phi_2$ , and  $\phi_3$  to discriminate against probe wobble signals.

b. The output of rotators  $\phi_1$ ,  $\phi_2$ , and  $\phi_3$  for flaw signals caused by the 100 percent T, 80 percent T and the 4-20 percent T fabricated defects in the standard tube, given the settings of rotators  $\phi_1$ ,  $\phi_2$ , and  $\phi_3$  for discriminating against probe wobble.

c. The settings of rotators  $\phi_4$ ,  $\phi_5$ , and  $\phi_6$  to discriminate against the support signals.

d. The components of peak signals at the input of rotator  $\phi_6$  ( $e_1$  versus  $e_2$ ) caused by the defects 80 percent T and 4-20 percent T when  $\phi_4$  and  $\phi_5$  are adjusted to produce a null signal for the signal caused by the 100 percent defect (wobble discriminated against, but no discrimination against the support signals).

e. The relative amplitudes of the peak output signals of the support ( $S_{23}$ ,  $S_{24}$ , and  $S_{25}$ ) and the 100 percent T, 80 percent T, and 4-20 percent T signals, all at output line 11.

Discrimination of signals will be illustrated by use of the plural signal rotator transformation unit shown in figure 5. In operation, the rotators  $\phi_1$ ,  $\phi_2$ , and  $\phi_3$  are adjusted manually to

produce minimum probe wobble signal (while the probe is caused to wobble) on lines 5, 6, and 7. These adjustments are made individually,  $\phi_1$  for line 5,  $\phi_2$  for line 6, and  $\phi_3$  for line 7. It is found in the example that the support signal is effectively a two-dimensional signal, occupying a two-dimensional subspace. This signal is discriminated against by adjusting iteratively the rotators  $\phi_4$  and  $\phi_5$  until the Lissajous pattern of this signal when viewing the signals on line 9 versus those on line 10 (or lines 11 and 12) collapses to as nearly a straight line signal as possible. Final discrimination is obtained by rotating rotator  $\phi_6$  to bring this nearly straight line to a horizontal position (minimum vertical deflection) when viewing signals on line 9 versus those on line 10.

In this example, these adjustments will all be calculated using the measured instrument response given in table 1.

We do not have the same flexibility in the calculations as we would have operating the rotators manually because of the large number of computations required to simulate the iterative manual adjustments.

### 3.3 Probe wobble discrimination

Equation (16) applies for discrimination against probe wobble:

$$\phi = \tan^{-1} \frac{x}{y} \quad (16)$$

where  $x$  and  $y$  are the input signals to a specific rotator and  $\phi$  is the rotator angle setting to discriminate against the signal vector  $x, y$ . Using the rotator designations given in figure 5 and noting from table 1 that the probe variable signal vector is

$$S_{12} = \begin{matrix} C_1 & C_2 & C_3 & C_4 \\ 17.9 & 48.3 & -6.0 & 229.8 \end{matrix}$$

we have

$$\phi_1 = \tan^{-1} \frac{17.9}{48.3} = 0.3706 \quad \phi_1 = 20.34^\circ \quad (24)$$

$$\phi_2 = \tan^{-1} \frac{48.3}{229.8} = 0.2102 \quad \phi_2 = 11.87^\circ \quad (25)$$

$$\phi_3 = \tan^{-1} \frac{-6.0}{229.8} = 0.02611 \quad \phi_3 = -1.50^\circ \quad (26)$$

The outputs of the first three rotators, the signals  $d_1, d_2,$  and  $d_3$  on lines 5, 6, and 7 in figure 5, are expressed by eq. (13) expanded here:

$$\begin{aligned} d_1 &= b_1 \cos \phi_1 - b_2 \sin \phi_1 \\ d_2 &= b_2 \cos \phi_2 - b_3 \sin \phi_2 \quad (27) \\ d_3 &= b_3 \cos \phi_3 - b_4 \sin \phi_3 \end{aligned}$$

Substituting the values of  $\cos \phi$  and  $\sin \phi$  for  $\phi_1, \phi_2,$  and  $\phi_3$  in eqs. (27) produces

$$\begin{aligned} d_1 &= 0.9377 b_1 - 0.3475 b_2 \\ d_2 &= 0.9786 b_2 - 0.2057 b_4 \quad (28) \\ d_3 &= 0.9997 b_3 - 0.0261 b_4 \end{aligned}$$

Next, substituting the values of  $b_1, b_2, b_3,$  and  $b_4$  of the peak signals  $S_{12}, S_{23}, S_{24}, S_{25}, S_{33}, S_{42},$  and  $S_{62}$  in eqs. (28) gives the following values for  $d_1, d_2,$  and  $d_3$ , the signals on lines 5, 6, and 7 in figure 5.

Probe Wobble	$S_{12}$	$d_1 = 0.00058$ $d_2 = -0.0035$ $d_3 = 0.0021$		
Support	$S_{23}$	$d_1 = 612.02$ $d_2 = -651.34$ $d_3 = -278.38$		
		$S_{24}$	$d_1 = 688.80$ $d_2 = -416.45$ $d_3 = -131.45$	
			$S_{25}$	$d_1 = 544.33$ $d_2 = -59.70$ $d_3 = 35.94$
100% T Hole	$S_{33}$	$d_1 = -173.36$ $d_2 = -70.09$ $d_3 = -436.88$		
80% T Hole	$S_{42}$	$d_1 = -175.31$ $d_2 = -46.75$ $d_3 = -366.58$		
4-20% T Holes	$S_{62}$	$d_1 = -234.61$ $d_2 = 12.82$ $d_3 = -210.53$		

The signals  $d_1, d_2,$  and  $d_3$  for vectors  $S_{23}, S_{24}, S_{25}, S_{33}, S_{42},$  and  $S_{62}$  are shown in figure 8 in three 2-space projections,  $d_1$  versus  $d_2, d_1$  versus  $d_3$  and  $d_2$  versus  $d_3$ . It is noted that these signals have been transformed from the original values on lines 1, 2, and 3 to new values because of the discrimination against the effect of probe wobble.

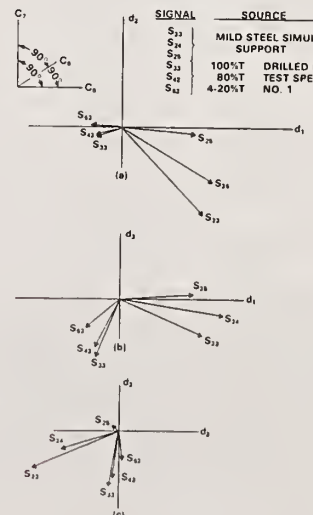

Figure 8. Three 2-space views of signals in 3-space.



### 3.4 Null display of signal

It is informative to determine the display of  $e_1$  versus  $e_2$  (fig. 5), the input to the final rotator  $\phi_6$  when rotators  $\phi_4$  and  $\phi_5$  have been adjusted to present a null view of the vector signal  $S_{33}$ , the 100 percent T signal. This view will show the relative disposition of the vectors  $S_{33}$ ,  $S_{42}$ , and  $S_{62}$  which are caused by the three flaw conditions 100 percent T, 80 percent T, and 4-20 percent T, respectively. It will also serve to clarify further solutions used for determinations of signals at  $e_1$  versus  $e_2$ .

The values of  $\phi_4$  and  $\phi_5$  to result in the null view of  $S_{33}$  at  $e_1$  and  $e_2$  are determined from eqs. (18) and (22) with substitution of the appropriate component values of the vector signal  $S_{33}$  ( $d_1 = -173.36$ ,  $d_2 = -70.09$ , and  $d_3 = -436.88$ ), and the previously determined values of  $\sin \phi_4$  and  $\cos \phi_4$ :

$$d_4 = \tan^{-1} \frac{d_1}{d_2} \quad (18)$$

$$\phi_5 = \tan^{-1} \frac{d_1 \sin \phi_4 + d_2 \cos \phi_4}{d_3} \quad (22)$$

It is found that  $\phi_4$  and  $\phi_5$  may have the following pairs of values:

	$\phi_4$	$\phi_5$
Pair 1	67.99°	-23.17°
Pair 2	67.99°	156.83°
Pair 3	247.99°	-23.17°
Pair 4	247.99°	203.17°

The last pair, Pair 4, gives the proper aspect of the vectors  $S_{33}$  (null),  $S_{42}$ , and  $S_{62}$  when  $S_{33}$  is chosen as the null vector and the direction of view is from the head of the vector  $S_{33}$  to the origin. The signal values at  $e_1$  and  $e_2$  (fig. 5) for these conditions are:

$$S_{33} \quad e_1 = 0.00079$$

$$e_2 = -0.00396$$

$$S_{42} \quad e_1 = 22.37$$

$$e_2 = -21.28$$

$$S_{62} \quad e_1 = 99.82$$

$$e_2 = -112.70$$

These and corresponding projections of the  $d_1$ ,  $d_2$ , and  $d_3$  axes are shown in figure 9.

### 3.5 Discrimination against support signals

It has been observed that the support signals can represent a two-dimensional subspace in the 3-space remaining after discrimination against the effects of probe wobble. This aspect of the support signals can be illustrated by taking the cross products of the vectors  $S_{23}$ ,  $S_{24}$ , and  $S_{25}$  (all at lines 5, 6, and 7) and then determine the angles between these cross products to find how closely the three vectors lie in a plane in the 3-space.

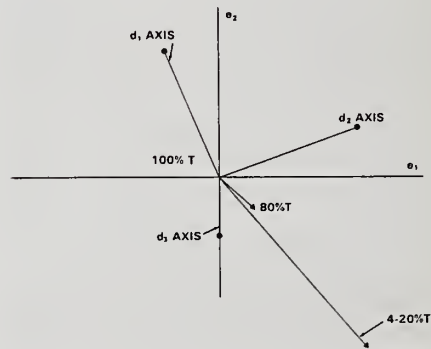

Figure 9. Calculated display showing peak signals.

Calculating:

$$U = S_{23} \times S_{24}$$

$$V = S_{24} \times S_{25}$$

$$W = S_{23} \times S_{25}$$

and noting that

$$\cos \gamma_{UV} = \frac{U \cdot V}{|U| |V|}$$

$$\cos \gamma_{VW} = \frac{U \cdot W}{|V| |W|}$$

$$\cos \gamma_{UW} = \frac{U \cdot W}{|U| |W|}$$

we find that

$$\gamma_{UV} = 2.85^\circ$$

$$\gamma_{VW} = 1.47^\circ$$

$$\gamma_{UW} = 1.88^\circ$$

Next, an average of three vectors U, V, and W is formed by adjusting their component values to that corresponding to the average length of U, V, and W. The resulting average is denoted vector D and the relative value of its components are:  $D = -3.1365, -12.6942, 23.2449$ . The vector D is normal to the approximate plane containing the three support signal vectors  $S_{23}$ ,  $S_{24}$ , and  $S_{25}$  on lines 5, 6, and 7 in figure 5.

We will now find two vectors, both normal to vector D and normal to each other to be used to calculate the settings of rotators  $\phi_4$  and  $\phi_5$  to produce a straight line (or near straight line) when viewing the support signals by displaying  $e_1$  versus  $e_2$ .

An attempt was made to build up the first vector  $S'_{25}$  by assuming it to be near  $S_{25}$ . The rotator angles  $\phi_4$  and  $\phi_5$  were then calculated to present a null view of the vector  $S'_{25} \times D$  at  $e_1$  versus  $e_2$ , as we did for vector  $S_{33}$  in figure 9. When this was carried through to completion, the results shown in figure 10 were obtained. (Calculations of this kind are discussed in more detail in the next few paragraphs.) The support vectors in figure 10 have been transformed as desired and they appear in a line, but the projections of the 100 percent T, 80 percent T, and 4-20 percent T signals are separated by an angle of only  $7^\circ$  or less. This is insufficient angle difference for practical use. The resulting display of these flaw signals also has a reverse phase angle aspect, that is, flaws farther from the metal surface produce signals having increasing leading phase angles.

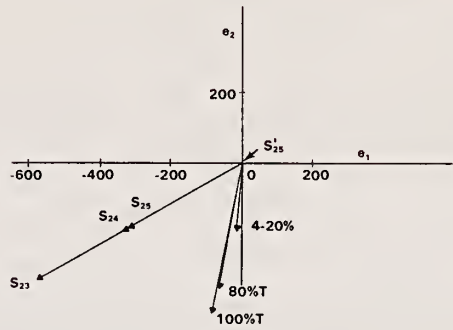

Figure 10. Input to rotator  $\phi_6$  with null vector normal to  $S'_{25}$ .

A second choice was made for the null vector at  $e_1$  versus  $e_2$ , based upon a small vector model of the signals at lines 5, 6, and 7. Inspection of this model indicated that a more reasonable choice of null vector would be one that is normal (or nearly normal) to vector  $S_{24}$  and, of course, occupying the approximate plane containing the three support signal vectors.

The vector D defines the subspace (plane) containing the support signals in an average kind of manner. The vector  $S'_{24}$  is determined by solving the equation

$$S'_{24} \cdot D = 0, \quad (30)$$

where two components of  $S'_{24}$  are assumed to be equal to two corresponding components of  $S_{24}$ . We know from eq. (29) that

$$S_{24} = 688.80, -416.45, -131.45 \quad (31)$$

We then assume that

$$S'_{24} = 688.80, q, -131.45. \quad (32)$$

Solving eq. (30) gives

$$q = -410.89. \quad (33)$$

The vector  $S'_{24}$  is the first vector needed which is normal to D. The second vector normal to D, and the one to be used as a null vector in the display which discriminates against the support signals is denoted  $S'$  and is equal to the vector product:

$$S'_{24} \times D = S'$$

It is found to be equal to

$$S' = 11,219.79, 15,598.86, 10,032.38 .$$

We find  $\phi_4$  and  $\phi_5$  by again applying eqs. (18) and (22) with  $d_1 = 11.21979$ ,  $d_2 = 15.59886$ , and  $d_3 = 10.03238$  to give:

$$\phi_4 = 35.73^\circ \text{ or } \underline{215.73^\circ}$$

$$\phi_5 = -62.43^\circ \text{ or } \underline{117.57^\circ}.$$

The underlined values are chosen as they result in the desired aspect when viewing the vectors in the  $e_1$  versus  $e_2$  display.

Again, the values of the other signals at  $e_1$  and  $e_2$  (fig. 5) given by eqs. (17) and (20) are:

$$S_{23} \begin{matrix} e_1 = -877.17 \\ e_2 = 167.44 \end{matrix}$$

$$S_{24} \begin{matrix} e_1 = -802.35 \\ e_2 = 146.20 \end{matrix}$$

$$S_{25} \begin{matrix} e_1 = -476.76 \\ e_2 = 92.82 \end{matrix}$$

$$S_{33} \begin{matrix} e_1 = 99.80 \\ e_2 = 314.09 \end{matrix}$$

$$S_{42} \begin{matrix} e_1 = 115.02 \\ e_2 = 260.01 \end{matrix}$$

$$S_{62} \begin{matrix} e_1 = 197.95 \\ e_2 = 128.04 . \end{matrix}$$

These results are shown in figure 11. The results can be seen in better perspective by now referring back to figure 9 wherein the 100 percent T signal is viewed "end-on," and the projections of the 80 percent T and 4-20 percent T signals are seen in accordance with their particular orientations. Now, referring to figure 11, we can see that we are viewing the 100 percent T signal from some other viewpoint, the one determined by the vector  $S'$ , which presents us with one "edge-on" view of the support signal plane. The support signals are thus viewed as being very nearly in line. It is now clear that the choice of vectors within the support signal plane other than  $S'$  as null vectors results in a rotation of all signals around a line perpendicular (normal) to the support plane and passing through the origin. When this pattern is rotated thusly, the projection aspects of the signals in the  $e_1$  versus  $e_2$  plane change greatly. The visualization of this is aided by again referring to figure 9.

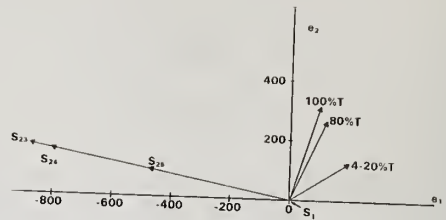

Figure 11. Input to rotator  $\phi_6$  with null vector normal to  $S'_{24}$ .

It remains, to obtain the discrimination against the support signals, to rotate the signal patterns in figure 11 so that the support signals produce a minimum signal in the ordinate direction, or the signal  $h$  on line 11, figure 5. This is done by adjusting rotator  $\phi_6$ . We note that the greatest angle spread of the support signals is between  $S_{23}$  and  $S_{25}$ , and it is  $0.60^\circ$ . The angle of  $S_{25}$  is

$$\theta_{25} = \tan^{-1} \frac{92.82}{-476.76} = 168.98 .$$

Assuming we need to approximately equalize the maximum positive and negative swings of the support signal, we should rotate the pattern in the counter-clockwise (positive) direction  $\theta$  degrees where:

$$\theta = 180 - 168.98^\circ - 0.4325 = 10.588^\circ.$$

The output of rotator  $\phi_6$  is obtained by using eqs. (13) and (14) which are rewritten here:

$$g = e_1 \cos \phi_6 - e_2 \sin \phi_6$$

$$h = e_1 \sin \phi_6 + e_2 \cos \phi_6 .$$

When  $\phi_6 = 10.59^\circ$  we find that

$$S_{23} \begin{matrix} g = -893.00 \\ h = 3.41 \end{matrix}$$

$$S_{24} \begin{matrix} g = -815.56 \\ h = -3.71 \end{matrix}$$

$$S_{25} \begin{matrix} g = -485.7 \\ h = 3.64 \end{matrix}$$

$$S_{33} \begin{matrix} g = 40.39 \\ h = 327.08 \end{matrix}$$



$$S_{42} g = 65.29$$

$$h = 276.72$$

$$S_{62} g = 171.05$$

$$h = 162.23$$

These values of  $g$  and  $h$  are used to produce figure 12, and it is observed that the support signals now have small components in the  $h$  (ordinate) direction, and the remaining signals have a practical orientation having the required phase angle direction.

The  $h$  signal components are:

$$S_{33} h = 327.08$$

$$S_{42} h = 276.72$$

$$S_{62} h = 162.23$$

$$S_{23} h = 3.41$$

$$S_{24} h = - 3.71$$

$$S_{25} h = 3.64$$

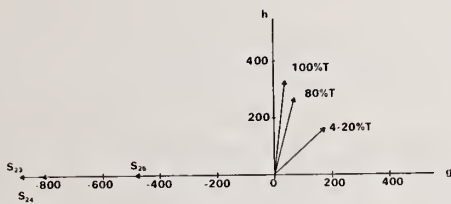

Figure 12. Output to rotator  $\phi_6$  with null vector normal to  $S_{24}$ .

These  $h$  components are plotted in figure 13 at a larger scale to show the large amount of discrimination more clearly. The amount of discrimination in this example is good. Although the three flaw signals in figure 12 appear to carry phase information, it should be emphasized that when the support signal occurs simultaneously with a flaw signal, the two are additive, and the horizontal ( $g$  component) of the support signal is added to the  $g$  component of the flaw signal. Phase angle information is retained when the flaw signals appear remote from the location of the support.

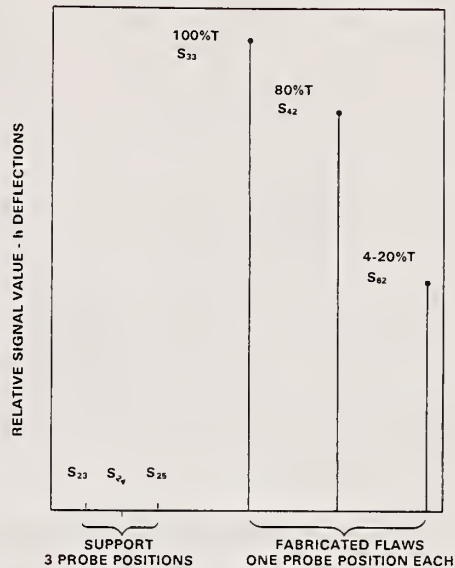

Figure 13. Calculated relative values of signals showing discrimination against tube support signals.

Another way to explain this effect is to relate it to the theory of the multi-frequency method. In this example, we have a four-variable or four-parameter system. Three variables have been "eliminated," one for probe wobble and two for the support. This leaves only one to be indicated at the output  $h$ . Of course, other variables not provided for by the system will also produce deflections in the ordinate direction.

### 3.6 Simulated cross-section display of tubing [3]

The multifrequency method promises to make it possible to perform many inspections not feasible with a single frequency (one frequency at a time) system. An example of this is shown in figure 14 in which a four-parameter system was used to discriminate against probe wobble signals and to separate inner wall and outer wall simulated flaws. Tubing radial position signals obtained from a resolver produced a simulated pattern of the tubing specimen on an X-Y cathode ray oscilloscope provided with capability of  $z$  axis modulation. The output of the four-parameter tubing inspection device modulated the pattern to show the relative location and relative severity of flaws opening on the outer and inner walls.

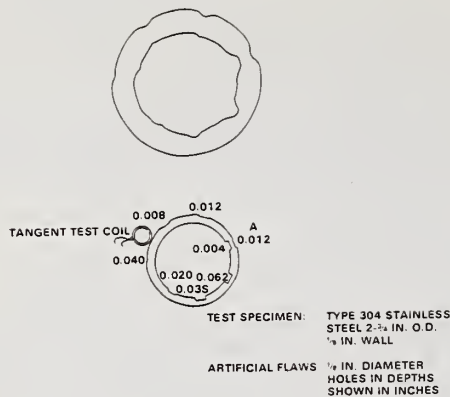

Figure 14. Simulated display of tubing cross section.

#### 4. Calibration Methods and Standards

The same general principles of calibration and use of standard specimens which apply to the single frequency eddy current technique also apply to multi-frequency techniques. However, with the more general method there are added complications resulting from the greater number of degrees of freedom and the associated larger number of specimen variables processed.

The most highly developed standards for eddy current application are conductivity specimens for calibrating electrical conductivity meters. In these applications, two standards are sometimes used for each meter scale, one for establishing a calibration point near the upper end of the scale, and a second for a point near the lower end of the scale.

Dimensional specimens are usually made by the laboratory or manufacturer interested in the application.

An area of increasing interest is that of standards for tubing inspection. Two conflicting needs are experienced: (1) the desire to produce effective standard irregularities which will cause signals similar to those from specified mill run flaws or to give other specified response, and (2) ease of fabrication.

Drill holes are often used because of the ease of fabrication and reproducibility of results. Holes are drilled through the wall or partially through the wall. Notches are sometimes made using

metal saws or by filing or machining. Grooves and other irregularities can be made by machining. A much used method for producing notches is the electric discharge machining process. Notches measuring a few thousandths of an inch wide to simulate cracks can be made by this method.

Drill holes do not represent exactly the common types of defect found in metals, but rather serve as convenient alternates by which the sensitivity and general performance of the inspection device can be set or measured. It is difficult to produce holes drilled partially through the wall from the inside of a tube. Notches are more costly to produce, but they can be made on the inside of tubing and give a much better simulation of cracks.

The nature of the calibration problem is complex and certainly cannot be treated adequately in this paper. Continuing research is being done in this area, and much more is needed. The development of standards for the eddy current tests have lagged behind that for the other major nondestructive tests. This must be at least in part caused by the abstract nature of electromagnetics and the associated problems in interpreting the wide range of signal effects observed. These, in turn, are a result of the indirect nature of the eddy current inspection. In many examples, the conditions which give rise to signal changes are only indirectly related to material or structural content.

The relationships between the calibration problems for the single frequency method and those for the multifrequency method can be clarified by referring to the section on principles. Let us first examine the algebra describing the single frequency technique. This is exemplified by eqs. (5) and (6):

$$a_{11} p_1 + a_{12} p_2 = C_1 \quad (5)$$

$$a_{21} p_1 + a_{22} p_2 = C_2 \quad (6)$$

These are simplified equations based upon small signal (linear) theory. However, they can be informative even though they do not describe the behavior of large eddy current signals. The coefficients  $a_{11}$ ,  $a_{12}$ ,  $a_{21}$ , and  $a_{22}$  each may depend upon all of the inspection variables. For our present purpose, we divide these inspection variables into

two groups. Group A includes the factors which can remain essentially constant during an inspection period, and Group B includes the factors which usually change during an inspection.

### Inspection Variables

#### Group A - Essentially Constant

- Probe assembly excitation
- Instrument AC bridge adjustments
- Instrument sensitivity
- Instrument signal phase adjust
- Instrument output channel sensitivity control.

#### Group B - Usually Expected to Vary

- Probe wobble effect
- Effect of test specimen
  - Electrical conductivity
  - Magnetic effects (if any)
  - Specimen and coil temperature changes (if any)
  - Presence of flaws and other irregularities within the test specimen.

Because of our assumptions regarding the fixed aspects of the coefficients  $a_i$ , in eqs. (6) and (7), we can consider them to comprise a modulation matrix which varies during an inspection mainly as a function of the inspection specimen. During a calibration period, the elements of this matrix are changed to new values, then being functions of the calibration controls such as gain or phase reference settings. The single frequency inspection output circuit has either one or two output channels. With two channels, the main calibration effects are changed in the gain of either or both channels and a rotation of the pattern in the  $C_1$  versus  $C_2$  display plane. Individual control of the gain of the  $C_1$  and  $C_2$  channels cause distortion of the signal pattern.

In contrast to the single frequency inspection technique the multifrequency technique is more complicated in two main

areas. Firstly, the number of algebraic equations (two for the single frequency approach) is increased by two for each new frequency added. Secondly, the outputs of the multiplicity of channels are further processed through additional circuits which are called transformation circuits in this paper. These additional circuits provide an involved mixing of the detector outputs for producing the desired separation of signals. The adjustment of these circuits is done in the calibration procedures. The equations applicable here for the two-frequency system indicate the increased complexity over that of the single frequency example are obtained by expansion of eq. (7).

$$\begin{aligned}
 a_{11} P_1 + a_{12} P_2 + a_{13} P_3 + a_{14} P_4 &= C_1 \\
 a_{21} P_1 + a_{22} P_2 + a_{23} P_3 + a_{24} P_4 &= C_2 \\
 a_{31} P_1 + a_{32} P_2 + a_{33} P_3 + a_{34} P_4 &= C_2 \\
 a_{41} P_1 + a_{42} P_2 + a_{43} P_3 + a_{44} P_4 &= C_3
 \end{aligned}
 \tag{34}$$

Again, as in eqs. (6) and (7),  $C_1 \dots C_n$  in eqs. (34) are the various detector outputs. The next equation relates these detector outputs to the final outputs.

$$\begin{aligned}
 b_{11} C_1 + b_{12} C_2 + b_{13} C_3 + b_{14} C_4 &= P'_1 \\
 b_{21} C_1 + b_{22} C_2 + b_{23} C_3 + b_{24} C_4 &= P'_2 \\
 b_{31} C_1 + b_{32} C_2 + b_{33} C_3 + b_{34} C_4 &= P'_3 \\
 b_{41} C_1 + b_{42} C_2 + b_{43} C_3 + b_{44} C_4 &= P'_4
 \end{aligned}
 \tag{35}$$

where the primed  $P'$  quantities indicate the final outputs, the estimated values of the parameters, and the  $b_{11} \dots b_{44}$  quantities represent the expansion of the  $[A]^{-1}$  matrix in eq. (11).

Further insight into the effect of the multifrequency system on calibration can be seen graphically by referring to figures 10 and 11. The transition from figure 10 to figure 11 is the result of rotating the vector signal pattern in 3-space around an axis normal to the support signals and passing through the origin. The effect of this rotation is to greatly change the relative angle separation between the three flaw vector signals. In contrast, variations in the



reference phase adjustment in the single frequency system cause just a simple pattern rotations.

## 5. Future Possibilities

The future of the multifrequency eddy current technique is very promising. It will produce results not possible with the single frequency method. Multifrequency equipment can be made to operate in several different modes, including single frequency modes. In its present stage of development, multifrequency devices are more complicated and more difficult to adjust and operate than single (one at time) frequency instruments. The development of automatic calibration means is needed.

The permission of Battelle-Northwest and the Electric Power Research Institute to use figures 4 through 13 and the basic data given in table 1 is gratefully acknowledged. Also acknowledged are the helpful suggestions of G. J. Posakony, Manager, Nondestructive Testing, Battelle-Northwest.

## References

- [1] Mc Master, R. C., ed., Nondestructive Testing Handbook, Vol. II, Ronald Press, New York (1959), Sections 36, 37, and 38.
- [2] Libby, H. L., U. S. Patent 3,229,198 January 11, 1966.
- [3] Libby, H. L., Broadband Electromagnetic Testing Methods, Part IV, Multiparameter Principles, BNWL-953, Battelle Northwest, Richland, WA, January 1969.
- [4] Libby, H. L., Multiparameter Eddy Current Concepts, in Research Techniques in Nondestructive Testing, R. S. Sharpe, ed., Academic Press, London (1970), pp. 345-382.
- [5] Libby, H. L., Introduction to Electromagnetic Nondestructive Test Methods, Wiley-Interscience, New York (1971).

- [6] Halmshaw, R., Potential Developments in NDT, The British Journal of Non-destructive Testing, 19, [1], 21 (January 1977)
- [7] Multifrequency Eddy Current Inspection for Cracks Under Fasteners, AFML-TR-76-209, Battelle Columbus Laboratories, December 1976.
- [8] Advanced Multifrequency Eddy Current System for Steam Generator Tubing Inspection, Report to Electric Power Research Institute by Battelle, Pacific Northwest Laboratories, Richland, WA, 99352 (to be published).
- [9] Libby, H. L. and Wandling, C. R., Transformation (Analyzer) Device Using Post Detector Signal Pattern Rotators for Multiparameter Eddy Current Tester, BNWL-1469, Battelle Northwest, Richland, WA, September 1970.

## Discussion

Question (Dr. Birnbaum): I would like to get back to your comment about nonlinear effects, even though your talk was not directed at that. Is there information there that can be used, for example, to deliberately try to look at the nonlinear effect as a flaw detection method?

Answer (Mr. Libby): Yes there is. I am limited here with the two frequencies, in this example. But the more frequencies we would include, and using Taylor's approximation, you can say a curve is a sum total of a lot of segments. So even though you have nonlinear effects, if you have enough information from the signal, then you can work with this. I think it is straightforward mathematically, All that I have described here, I have done by hand -- by pocket calculator, but this can all be done using algebra or through the computer. You can use all of the regression techniques, and nonlinear approximations. It is just more difficult to do.

I have tried the method described with magnetic materials with just a few frequencies and the results were discouraging. But I think only because I did not have enough information, enough different frequencies, to describe all of these curves.

Question (Dr. Birnbaum): I was thinking more, for example, of using two frequencies

$U_1$  and  $U_2$ , and looking at the sum frequency which is created by a nonlinear interaction.

Answer (Mr. Libby): This is done now. The 60-cycle testing of magnetic materials over the years has made use of these harmonics, and they are present there.

This is a relationship that can be further explored. I feel this is just a start. We have just scratched the surface. There are all kinds of possibilities and this is where the microprocessor will help to handle the greater amount of information that can be made available.

Question (Mr. Wehrmeister): Was this system designed specifically for detection, or do you receive from it information that provides defect analysis in terms of its depth?

Answer (Mr. Libby): So far, we use mainly the amplitude of the signal to determine the severity of the condition. If I have several flaw conditions, more than is accounted for by the number of variables that I can handle, then any of these flaw conditions appearing individually will show up with a phase angle difference, like the 100, the 80 and the 20 percent flaws.

Now, that phase angle difference will show up on the screen as long as I am translating the coil past those flaws. But now, if I put the support right on top of the flaw, the support signal is in the horizontal direction.

Consider the flaw signals now. Even if they occur right at that same point as the support signals it will not change their vertical contribution at all. But, in this case I have used up all the degrees of freedom I am entitled to. I have used one parameter for wobble, two for the support, and I have got one left to read out one additional parameter.

But if I have three parameters, I say, there are the 100 percent, the 80 percent, and the 20 percent flaws. There is some limitation here. I have to throw out the other two. Generally, you do not have flaws appearing under the support, so you can use the angle information. But when they occur under the support, then I can use only the amplitude information.

Question (Mr. Blew): On your example, there was a scaled amplitude of 200 millivolts. What is the actual amplitude of the smallest flaw that you can handle with a signal-to-noise ratio that would allow you to detect it accurately?

Answer (Mr. Libby): Well, this varies a lot. It would vary with application. It depends on the material and the particular test, and the noise level.

Question (Mr. Blew): What would you think the practical limitation would be?

Answer (Mr. Libby): Well, I do not know what the limitation is, actually. We have worked with flaws a few mils -- in depth. But now if we are discriminating against a support on the outer wall, the tests are more insensitive to small signals on the outer wall than in the regular test.

Question (Mr. Blew): Would this have been in about a mil?

Answer (Mr. Libby): I just cannot tell you what the limitation would be.

Question (Mr. Blew): With practical experience are you getting down into the millivolt region of signal?

Answer (Mr. Libby): Well I think this is just relative as far as the millivolts. That depends on how much you are driving the coils, what the instrument gain is. I had those units on the example to help me in my calculations, so I carried through all those relative amplitudes from the start, starting with the basic data.

Question (Mr. Brown): From the standards and calibration point of view, is it true to say that you have to have a sample of each of the parameters that you are juggling? If there are one or two things you want to get rid of, you have to have a sample of them; and if there are one or two things you want to measure out, you have to have a sample of them. So, the standard for multiparameter testing might very well have several different kinds of parameters on the standards.

Answer (Mr. Libby): And there is this problem. If you are using a system like the one I described where I am manually adjusting, the electronics could be



arranged so that it will aid this adjustment. That is something for the future, where the processor, micro-processor would come in. You need to present these parameters in fairly rapid sequence if you are doing it manually, because you have several things to minimize. I have got to go across one, two, three parameters, and if there is one in there that I do not want to minimize, then I have to remember that. And I must minimize wobble at the same time. Of course you can do the wobble separately. But, in the first generalized adjustment where there are three knobs to adjust, three or four parameters, then you have got to wobble the probe at the same time. You could do the wobbling, and then as you pass the different parameter signals, different flaws that you are calibrating against, then minimize them that way. In some cases, you can do them one at a time, but you have to be careful.

This is a more costly system, and it is more complicated to adjust, more complicated to operate. But as it becomes more automated, we can make automatic calibrations.

Question (Mr. Berger): I think you really answered the question I was going to raise. Because your original answer to his question implied that you needed a physical standard in order to calibrate the distance. I was going to question that. I think you could store in computer memory what the signals would look like.

Answer (Mr. Libby): Like the system that was described; yes, an approach like that could be used. Yet, there are some subtle things here. I do not want to oversimplify it in a few slides like this, but it represents many years of effort. And there were a lot of difficulties along the way.

You must be careful. For example in the wobble adjustment, I kind of glossed over that. It was just stated that there is wobble adjustment, which gets rid of the wobble. And I said it just like that, and it comes out beautifully on the slide. But the output signals, especially the phase angles between the final output signals that I showed for those three flaws, are fairly sensitive to the wobble adjustment, because you are dealing with all these different dimensions. Once you adjust for it, then it can hold. But you do not want to change your mind after you have it calibrated.

Comment (Dr. Mc Master): If I may use the board a moment, I want to mention one little thing I found that helped me on wobble with probe coils and could be used here to get that one nasty variable out. It applies to other coils as well.

To take a very simple case, our magnetizing coil might provide a certain number of ampere turns or magnetizing force or flux density or signal in the vertical direction. And if we put in ferromagnetic materials, we will increase the flux, so that you get a larger resonance curve.

If, with respect to, say, a probe coil and the surface, you have a liftoff,  $S$ , and if you were to wiggle the probe up and down, say, through a modestly adequate range to be greater than any effects of surface displacement, it is possible to arrive at a very interesting situation. If this represents the 100 percent signal in air, in the absence of the test object, it is something you can easily calibrate an instrument to.

If this is your curve with the ferromagnetic material present, then this point also represents a vector of 100 percent magnitude. Notice, the phase has changed. But you can wiggle from here to here with negligible change in the overall signal. It sits there at 100 percent all the time. So all you do is tune the oscillator with the ferromagnetic object in place such that when you wiggle this up and down there is no visible effect on your signals, and then read out a frequency of balance, if you will, whatever you want to call it, a frequency which restores 100 percent signal, which often can be read out rather accurately.

I find very frequently when you read out frequency instead of other parameters, you get about five figures of stable indication. So I have often thought that in cases where wobble is a problem, if you took it out at the probe by the selection of the frequency which is automatically self cancelling for liftoff of huge amounts, and then went into what you are doing, it seems it would be helpful.

Question (Mr. Bugden): If you use two frequencies, is the relationship of the two frequencies to each other, of great consequence?

Answer (Mr. Libby): I like to work with two to one or three to one, but we have



proved mathematically that as long as you take different frequencies, no matter how close together they are, the independence of information exists. The signal-to-noise ratio may or may not improve depending on the choice of frequencies. No matter how close together you get these frequencies, theoretically, there is some difference, but when the skin effect becomes more equivalent for the different frequencies, you have less difference in signals to work with.

Question (Mr. Bugden): Do you choose the frequencies for convenience?

Answer (Mr. Libby): Yes.

Question (Mr. Mester): Have you determined the amount of liftoff that you can compensate for?

Answer (Mr. Libby): I do not have an exact figure, but it will compensate for a rather large amount.

Question (Mr. Mester): Has this work been confined to ID coils or have you worked with surface coils?

Answer (Mr. Libby): Well, I have used surface coils for conductivity variation, and variation in thickness, conductivity being one variable, thickness the other. We have used encircling coils, and small probe coils. I said it was not good for magnetic materials, but if, for example, you have magnetic inclusions, just below the surface of the material, it is very good for detecting that; it eliminates the wobble effects and some other variables and detects the magnetic inclusions. Or, if you wanted to cancel that out, and read some flaw signals that occur near it, this could be done. But this is when you have a small amount of magnetic material.

Question (Mr. Mester): Is this system described in a document that is available?

Answer (Mr. Libby): Yes, and there are references in it to some of the previous work. There is also a reference to a new report that will be made available to the public through EPRI, which includes this work, plus additional information, but that has not been issued yet.



## PULSED EDDY CURRENT TECHNIQUES FOR NONDESTRUCTIVE EVALUATION

D. L. Waidelich

University of Missouri  
Columbia, MO 65201

### 1. Introduction

The pulsed eddy current system has been used for the nondestructive evaluation of materials since the early 1950's. Some of its advantages are much less thermal drift and much greater resolution than for systems using continuous sinusoidal waves. A typical system is described and some of the waveforms are presented. Also, it is shown that the problem of lift-off may be overcome by employing the idea of crossing points. An equation involving the pulse length, the material constants and the depth of penetration is developed. Some results obtained when testing non-metallic materials are given and also some recent experiments with thick metallic slabs are discussed. Finally, various problems are presented and some suggestions are made.

### 2. Previous Work

Much of the early work on the pulsed eddy current method was summarized in a recent reference [1]<sup>1</sup>. In the early 1950's, eddy current systems used single frequency sinusoidal sources, and the subsequent heating of the probe coils led to thermal drifting which, in turn, caused errors in locating defects. It was decided to use a pulse generator to drive the probe coil, and the thermal problem disappeared immediately. There was a new problem, however, in trying to interpret the results as viewed on the screen of a cathode-ray oscilloscope. It was found quickly that the defects near the surface of the metal would show up in the first part or head end of the pulse, while those deeper in the metal would affect the tail of the pulse.

A block diagram of a typical system is shown in figure 1. The first systems employed had a pulse generator driving a probe coil which launched the electromagnetic waves in the specimen of the metal to be tested. The pickup coil responded to the waves issuing from the metal and containing the information concerning the defects in the metal and the properties of the metal. The output of the pickup coil was observed on an oscilloscope. Later, the output was filtered in various ways, and an electronic gate was used to pick out a particular portion or portions of the output wave for recording. Recording may be done as a continuous trace on paper or as a digital readout printed periodically. The output could also be entered into a computer for further processing, such as digital filtering, the employment of a decision process, or an adaptive method involving storage. Various forms of alarms or marking devices could also be actuated.

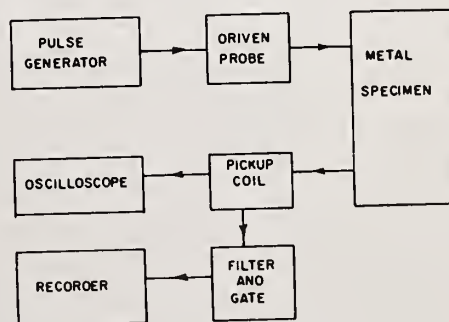

Figure 1. Pulsed eddy-current system.

<sup>1</sup>Figures in brackets indicate the literature references at the end of this paper.



The most usual circuit supplying energy to the driven probe consists of a capacitor D which is charged slowly through a resistor R from a dc power supply as shown in figure 2. The capacitor is then discharged suddenly by a

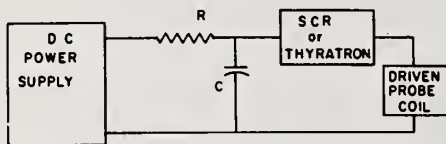

Figure 2. Circuit supplying the driven probe.

silicon-controlled rectifier (SCR) or a thyatron through the driven probe coil. The pulse waveform is very nearly a half-wave sinusoidal loop as shown in figure 3, and the length of the pulse is determined primarily by the quantity  $\sqrt{LC}$  where

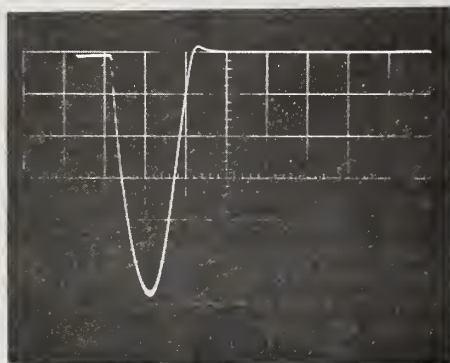

Figure 3. The current through the driven probe.

L is the inductance of the driven probe coil and C is the capacitance of the capacitor. The pulse shown is about two microseconds long and has a peak value of approximately 12 amperes. There is a little tail to the pulse which is caused by the deionization of the discharge device. The shape of the current pulse is not very important because the metal acts as a low pass filter. Consequently, the higher harmonics contained in a rectangular pulse, for example, will be attenuated rapidly and the result in the pickup coil will be nearly the same as if the driving pulse were a half-wave sinusoidal loop.

The pickup coil voltage is shown in figure 4. Note that there is an initial jump in voltage, then a sinusoidal shaped

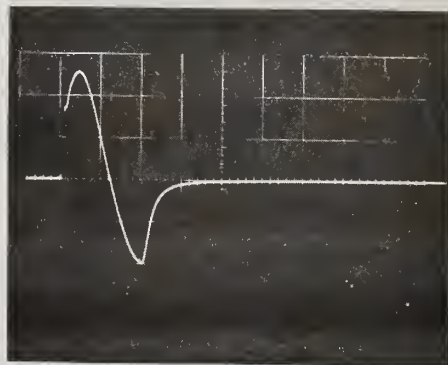

Figure 4. The voltage across the pickup coil.

curve and finally an exponentially decaying voltage. Defects and changes in the material properties change the shape of the voltage from the pickup coil. These changes carry the information about the defect or the material property, and this information may be abstracted by the proper method.

One of the problems is the effect of "lift-off." This may be overcome by employing the idea [2] of the "crossing point." If the pickup is placed directly upon a metal specimen, part of the pickup coil voltage of figure 4 is shown as the curve AA' of figure 5. As the coil is

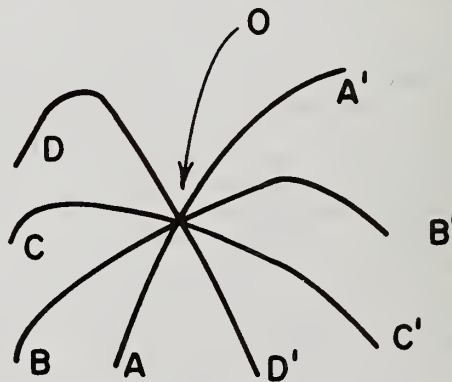

Figure 5. Crossing point.

moved away or lifted from the metal surface, the trace of the pickup coil voltage successively moves from AA' to BB', then to CC', and finally to DD'. The crossing point O, however, is not affected by lift-off, and so if the pickup coil voltage is sampled electronically at the crossing point O, the output of the sampler will be completely independent of

lift-off. The position of the point 0 will depend upon the presence of a defect or upon the properties of the metal specimen, so its motion may be used to locate a defect or to determine metal properties without worrying about the effects of lift-off.

### 3. Recent Work

One important relationship in pulse work is that between the length in time of the pulse, the constants of the materials being tested, and the depth of penetration of the electromagnetic waves into the materials. In the Appendix, it is demonstrated that

$$T = \sigma \mu D^2 \quad (1)$$

where  $T$  = length in seconds of the pulse;  $\sigma$  = electrical conductivity of the material in mhos per meter;  $\mu$  = magnetic permeability of the material in henries per meter; and  $D$  = depth of penetration into the material in meters. In some recent work in aluminum and using pulses about a millisecond long, this equation has been found to be useful in predicting the depth of penetration.

Some work on testing poor electrical conductors, such as plastics, indicated that the above magnetic probes were not very successful. The material seemed to have relatively little effect upon the magnetic flux lines emanating from the probes. It was thought that this type of material might react more on the electric flux lines, so capacitive probes were fashioned and simulated defects in plastic materials were detected by the use of pulsed waves launched by the capacitive probes [3]. Accidentally, it was found that these probes were also extremely sensitive in picking up and locating bits of metal in the plastics.

Lately, experiments have been made aimed at transmitting the waves through an inch or more of aluminum and in detecting defects in a second metal layer through about a quarter inch of aluminum. Also defects in steel have been detected through a quarter inch of metal by using the set-up shown in figure 6. The magnetic field is generated in the steel by using a coil wound on the elongated C-laminations. When the current in the coil is cut off, the field collapses, and

the field is detected on the surface of the steel by the small magnetic probe coils. The presence of a defect in the steel is indicated by aberrations that occur in the detected field. Some work has also been done in detecting defects in composites such as those made of graphite.

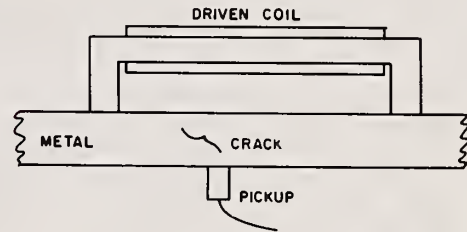

Figure 6. System employed for ferrous material.

### 4. Questions and Suggestions

It appears as if further knowledge is needed in the direction of what are the limits as to the thickness of materials that may be traversed by the electromagnetic waves. Equation (1) may be modified by the state of the art, for example, by the sensitivity of the detectors available and, undoubtedly, by the noise present. The question also arises, does this equation or a similar one apply to poor conductors, semi-conductors, and insulating material? There is another problem that occurs when defects are detected from one side of a material as compared to through-transmissions, and this seems to indicate that the  $C$  of the Appendix should be greatly reduced when through-transmission is employed. There is also a considerable amount of work that should be done on the probes employed. Two problems especially would be important in this direction. The first would be the development of better probes for the poorer conductors and better insulators, and the second would be the investigation of the masks or shields for use with longer pulses to provide better resolution. Further work is needed in the use of electronic gates, amplifiers, and the devices that record the information. Also methods of decreasing the noise are needed, and these would include correlation methods and all types of filtering. A number of theoretical studies would help greatly in understanding the processes and in determining optimum operation of the equipment.



## References

- [1] Waidelich, D. L., Pulsed Eddy Currents in Research Techniques in Nondestructive Testing, R. S. Sharpe, ed. (Academic Press, London, 1970), pp. 383-416.
- [2] Waidelich, D. L. and Huang, S. C., The Use of Crossing Points in Pulsed Eddy Current Testing, Materials Evaluation, 30, 20-24 (January 1972).
- [3] Decker, W. A. and Waidelich, D. L., Nondestructive Testing Using an Electric Field Probe, in Proceedings of the Seventh International Conference on Nondestructive Testing, Warsaw, Poland, June 1-8, 1973, Paper D-02.

## Appendix

Assume that the surface of the material is the x-y plane and the positive z-axis extends into the material. The conductivity of the material is  $\sigma$  mhos per meter and the magnetic permeability is  $\mu$  henries per meter. The vector Helmholtz equation for the magnetic field intensity  $H$  is assumed independent of  $x$  and  $y$ . In addition, the Laplace transform is employed to introduce the complex variable  $s$  in place of the  $t$  in seconds.

Then

$$\frac{d^2 H}{dz^2} = \sigma \mu s H \quad (A-1)$$

and the solution is

$$H = (H_0/s) e^{-z\sqrt{\sigma\mu s}} \quad (A-2)$$

where  $H_0$  is the initial magnetic field intensity at the surface ( $z = 0$ ) of the material. Now the exponent of (A-2) must be dimensionless, and since  $s$  has the dimension of the reciprocal of the time  $T$

$$T = C \sigma \mu D^2 \quad (A-3)$$

where the depth  $D$  is used in place of  $Z$ , and  $C$  is a dimensionless constant. To determine the approximate value of  $C$ , known values of  $T$ ,  $\sigma$ ,  $\mu$ , and  $D$  may be

introduced in (A-3). For example, it has been found in nonmagnetic stainless steel that pulses 2 microseconds long may be employed to reach depths of 40 mils (1 millimeter) in the steel. Now if  $\sigma = 1.1 \times 10^{-6}$  mhos per meter and  $\mu = 4\pi \times 10^{-7}$  henries per meter, then  $C = 1.447$ . The actual pulse length is not at all critical, so for most work  $C$  is put equal to unity in (A-3). The actual value of  $C$  depends somewhat on the state of the art in that if more sensitive detectors are employed,  $D$  would increase for a given  $T$ , and thus  $C$  would have to be decreased. Also, the effect of the noise present would change  $C$ . The above value of  $C$  was obtained in detecting defects from one side of the material. If through-transmission is employed, it appears from some tests as if the value of  $C$  should be reduced to about 0.05.

## Discussion

Question (Mr. Wehrmeister): In pulse eddy current work, what are the effects from acoustic energy generation in the transmission of the pulse? Are some of the time delays that you refer to the acoustic energy being transferred to your pickup coil, as opposed to the electromagnetic energy being transferred to the pickup coil, especially in magnetic material?

Answer (Mr. Waidelich): In all tests, there was no actual contact with the material, so it would be rather difficult to get very much acoustic ultrasonic type transmission across the air between the pickup coil and the material itself. Undoubtedly, there is some motion in the specimen, the metal specimen itself. But I have seen relatively little effect that can be noticed.

Question (Mr. Blew): In your work, when there was a conducting film in the air or when there were films on a conducting base metal, what would be the minimum thickness that could be resolved, and how close were the respective conductivities to each other?

Answer (Mr. Waidelich): The example, if I remember, was zirconium on uranium. I do not remember the conductivities too well, but both are relatively poor conductors. The closer the conductivities become, the more difficulty you have in separating them.



Question (Mr. Blew): And what were the relative thicknesses?

Answer (Mr. Waidelich): The thickness of the cladding was about 30 mils, something of that order.

Question (Mr. Blew): And the base?

Answer (Mr. Waidelich): The base was quite thick. I would say easily a quarter inch.

Question (Mr. Mester): In the example where you have a quarter inch of steel as the limitation of what you have penetrated, was DC saturation used during the test?

Answer (Mr. Waidelich): No, we had not used that in that particular example. We were going to do that in one of the future experiments.

Question (Mr. Mester): What power levels are involved with your inputs to your driven coil?

Answer (Mr. Waidelich): We were using approximately a 100 volt pulse. I cannot tell you what the current was. We did not measure the current.

Question (Dr. McMaster): How big were the capacitors?

Answer (Mr. Waidelich): We used a number of sizes. That is something like .01, .05, .1, .5  $\mu$ F.

Question (Mr. Bugden): Is there any particular ratio between the duration of the pulse and the whole cycle that you find beneficial?

Answer (Mr. Waidelich): It depends on how thick a metal is tested. The electromagnetic waves penetrate and are reflected from the back surface. The deeper a metal, the more time it takes for this process to occur. This is indicated in this equation to some extent. If you put a particular pulse into a thick metal, oftentimes the information you are looking for comes a long distance after the input pulse is stopped. You might find that you get something like this in your pickup coil--that is, a long tail. This tail can be quite long. The surface information is prior to this, and the deep information is way down here some place.

Question (Mr. Mester): You mentioned a thermal problem.

Answer (Mr. Waidelich): The heating that exists when using sinusoidal currents causes a lot of drift. The drift caused difficulty in getting everything nulled out. But, for one pulse the thermal effect is relatively small. You can put a large current in this one pulse and get quite a strong response. The only trouble in doing this is the problem of trying to pick up the information afterwards. You do not have the advantage of using all the sinusoidal methods.



## THE INTRODUCTION OF SIGNAL PROCESSING TECHNIQUES TO EDDY CURRENT INSPECTION

E. E. Weismantel

Quality Measurement Systems  
The Aircraft Engine Group  
General Electric Company  
Cincinnati, OH 45215

### 1. Introduction

The use of eddy current techniques for the nondestructive interrogation of materials is not a new consideration since the process has been in use to some degree for this purpose since the Second World War. As with any advancing technology, the increased application of the process results in a firmer definition of its best uses as well as its limitations. The basic process itself offers a very high sensitivity for finding small material flaws in the near surface region. However, because the process is very sensitive, it also responds to other non-flaw type conditions that may exist during the normal application of the process. Typical major influences are: localized changes in conductivity due to alloy segregation, thermal effects, or residual strain patterns within the material, as well as factors that would also affect the reactance of the system such as coil to metal intimacy, part configuration, etc. Such factors have perhaps inhibited the broad application of the process more than anything else since, except for specific applications where the effect of these other influences could be minimized or where the flaws being sought were large enough as to override the effects of these other factors, the eddy current process sometimes developed suspicions as to its reliability. The early uses of the process were further hampered by the characteristics of the early instrumentation that was available for its application since the meter display of this vintage integrated the effect of all of these influences into a single meter readout.

### 2. Current Trends

It has only been in the last five to ten years that advances in the process technology itself, coupled with the availability of a new generation of electronic equipment concepts, has markedly broadened the potential of the process.

This recently available equipment allows the use of the impedance plane for the analysis of eddy current signal response. A typical impedance plane presentation is illustrated in figure 1. This illustration shows the position of various materials on the impedance plane relative to their reactance and resistance effects on the coil. Differences in the electrical conductivities between materials are illustrated on the resulting plots. The occurrence of flaws within an alloy generally results in a small change along this curve. Coil-to-material spacing on the other hand, assumes a vector direction as shown toward the "Air" termination point on the conductivity curve. Thus, with the use of the impedance plane, one gains the ability to observe whether the coil's reaction is due to a change in conductivity or due to coil to material spacing, probe wobble, etc.

A typical commercial instrument is shown in the next illustration, figure 2. This instrument has an added feature in the rotational knob shown on the upper left hand portion of its front panel. This control provides a control over the display which allows the rotation of the impedance plane so that the lift-off effect, for example, can be made to occur in a specific coordinate direction. Without the rotation feature, effective use of the impedance plane relies on the observational skills and attentiveness of



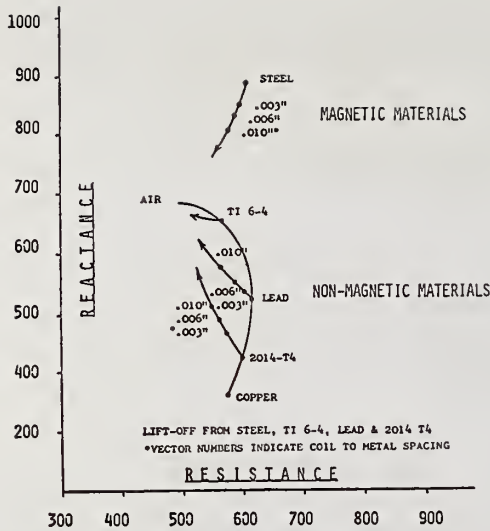

Figure 1. Impedance Plane.

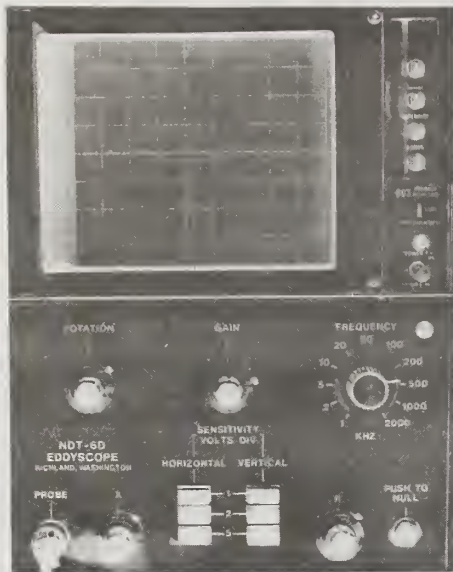

Figure 2. Typical commercially available eddy current instrumentation.

the operator since both the lift-off vector and the conductivity effects contain both vertical and horizontal components, and the plotting of horizontal and vertical output data on normal recording instrumentation would be of little value for most applications. However, the rotational feature of present day instrumentation becomes of significant importance to the process. With this feature, the vector representing lift-off conditions can be brought to react in an almost entirely horizontal direction while

the output along the conductivity curve consists of both horizontal and vertical movement. This is diagrammatically shown in figure 3. If a two channel recorder such as that shown in figure 4 is adapted to the recording of output data from the rotated impedance plane, the one channel can be arranged to contain the vertical movement along the conductivity curve while the second channel contains a composite of the movement in the lift-off direction and the horizontal movement associated with conductivity change effects. A typical presentation of this is shown in figure 5.

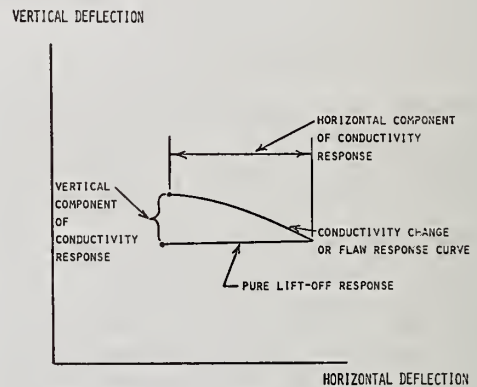

Figure 3. Representation of typical lift-off and conductivity change response on the rotated impedance plane - lift-off horizontal.



Figure 4. Dual chart recorder used for data gathering.

LIFT-OFF REACTION ESTABLISHED AS PURE HORIZONTAL MOVEMENT  
CHANNEL 2

VERTICAL COMPONENT OF CONDUCTIVITY CHANGE - CHANNEL 1

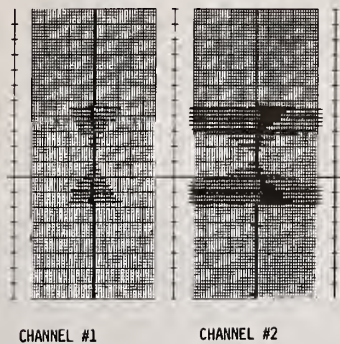
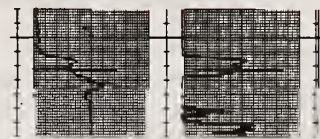

Figure 5. Illustration of typical recorded eddy current response.

### 3. Other Application Influences

Thus far, we have done little more than to manipulate the impedance plane, but from these illustrations the ease with which we can derive more meaningful data from the eddy current response should be evident. Unfortunately, to this point, we have been using idealized illustrations to show the significance of recent advances in eddy current instrumentation and application methods with regard to the potential of the process. In facing real world situations, even though these advances are certainly significant, a number of other factors are encountered that further cloud the interpretation of signal response resulting from the use of the process. Figure 6 shows a strip chart recording of the typical eddy current response observed in the inspection of turbine blade edges using all of the innovations we have discussed to date. Certainly, even though a flaw signal is evident on this recording, the chance for operator misinterpretation remains high due to the confusing response associated with the blade edge inspection. The changes evident during this inspection occur due to changes in electrical conductivity along the cast airfoil as well as changes in geometric configuration from platform to tip. The eddy current process is sensitive to both of these effects as the recording shows.



0.070" LONG CRACK (NATURAL FLAW)

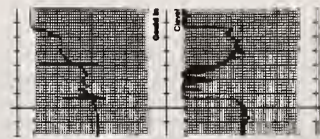

0.006" DIAMETER x 0.080" LONG HOLES - 0.003" BELOW THE INSPECTION SURFACE



FOUR EDM NOTCHES - 0.020" x 0.010"

Figure 6. Illustration of typical eddy current response on turbine blade edges without signal processing.

### 4. Overcoming Geometry and Conductivity Effects

Sometime back when General Electric first undertook the task of applying eddy current inspection in the production environment, we recognized that the variabilities we have discussed thus far might affect the reliable use of the process, and we, in fact, delayed the use of eddy current inspection by production operators until a more interpretable condition could be established. With the cooperation of the equipment vendor, we evolved into the use of signal processing as a useful tool to further enhance implementation of the process. Naturally, the first use of signal processing involved a black box which is illustrated in figure 7. This addition to the normal eddy current inspection equipment already described yielded a dramatic increase in the interpretability of the eddy current signal as is evidenced in figure 8. The upper portion of this illustration shows the signal response normally resulting from an airfoil blade edge containing known flaws. Although the response of the flaws is evident to a trained operator for most of the airfoil, certainly as flaw size and thus the response gets smaller, the chance for a miss on the part of the operator increases. The lower portion of this diagram shows the inspection of the same airfoil edge using the



processed signal. Clearly, the effects of conductivity and geometry changes have been all but eliminated, the flaw response originates from a constant baseline, allowing a better judge of relative signal amplitude, and the signals resulting from flaws are clearly evident.



Figure 7. Signal processor used with eddy current instrumentation.

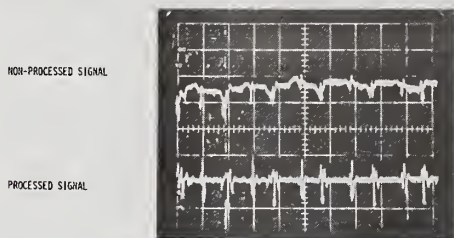

Figure 8. Direct comparison of processed vs. non-processed eddy current signal.

This very elementary approach to signal processing consisted only of the removing of the gradually changing responses due to geometry and conductivity while allowing the more discrete and abrupt changes due to flaw conditions to remain. Because we were concerned that these attempts to improve operator interpretability might degrade the very excellent flaw detection capability of the eddy current process, a statistically designed experiment was undertaken to assess the detection efficiency of the process both with and without the use of signal processing. The test consisted of the eddy

current inspection of a series of grooved blocks--representative of a fillet condition. Three different alloys were used in the experiment. Each groove contained up to three fatigue cracks in a size range varying from 0.010 to 0.250 inches. A total of 131 cracks was used in the evaluation. The result of this study is presented in figure 9. The superior flaw detection capability of the process seems to have been unaffected by the signal processing used for these tests. In fact, in the small crack size end of the curve, the detection efficiency of the process seems to have been improved probably due to enhanced operator interpretability. With this background, we introduced the use of processed eddy current signals to the production inspection of blade edges more than a year ago. Increased benefits of further signal processing developments appear to be obtainable.

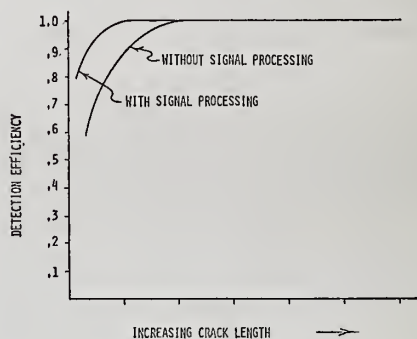

Figure 9. Relative improvement in flaw detection performance resulting from signal processing.

Until now we have discussed things that have already happened specifically with regard to signal processing. These improvements have resulted in the ability to get some intelligence out of the eddy current inspection data and have opened the way for the further adapting of the process to the use of the computer for the further advancement of application technology. Typically, today's inspection of cast airfoils uses a varying accept/reject level depending upon where along the airfoil a response must be considered. The most critical portion near the airfoil fillet allows a maximum response amplitude of 10 percent as shown in figure 10. Higher allowable amplitudes exist as one goes outward from the platform due to the lower stresses and lesser criticality in these areas. Currently, effort is underway on a semi-automated inspection system which uses microprocessors to control the



movement of the inspection probes as well as the acceptability of the signal response observed along the airfoil edges relative to the probe's position at the time the response is observed. Many other possibilities exist for the application of further signal-processing techniques to the process as we move to the future, but one major unknown feature must yet be recognized.

process. Even though current efforts to extend the technology should and will continue, it is only through the enhancement of our theoretical understanding of the process that the value of multifrequency testing and other advanced methods can really reach their full potential.

## 6. Summary

1. The introduction of the impedance plane to practical use has opened many avenues for improving the interpretation of eddy current signal response.
2. The rotation of the impedance plane to differentiate the characteristics of the response further enhances the application of the process.
3. Signal processing methods can be applied to improve the interpretability of the response.
4. With these accomplishments, the use of eddy current inspection can be tied to microprocessors and computer control.
5. Although marked advancements have been made in the application of the process much theoretical work remains to be done to gain its full value and potential.

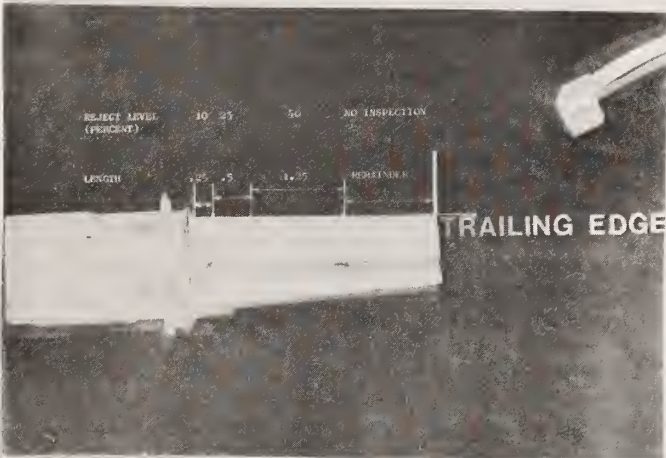

Figure 10. Inspection criteria for typical turbine blade edge.

## 5. Looking Into the Future

Certainly the use and value of eddy current technology has increased markedly in the recent past. However, as we look into the future we must recognize how much more we have to know if we are to use signal processing of eddy current responses to its fullest advantages. Currently, the application of the process is guided by a few basic laws of physics and electronics supported by an amount of empirical derivations and technical logic. Few of these really define the conditions we experience in the testing of the complex metallurgical alloys which forms our every day work and to which the process is to be applied. Therefore, we have to work towards the development of a theoretical understanding of the process used in these situations supported by computer modeling to help predict the needs and performance of the

## Discussion

Question (Mr. Judd): The signal processing device that was shown on one of your slides, is this commercially available?

Answer (Mr. Weismantel): I expect it probably is commercially available today. It was developed on this program with the cooperation of the equipment manufacturer. He has a unique advantage in the fact that it is applicable to his equipment but not to some of his competitors' equipment without going into the internals of the competitors' equipment.

Question (Mr. Judd): Is this device essentially a wave shaper?

Answer (Mr. Weismantel): I did not fully describe the total application of the signal processor. It has several different functions. The one that I was describing involved the filtering out of

lower frequency occurrences that are associated with geometry and with chemistry changes. These occur rather gradually, whereas a flaw response is a very sharp occurrence. And, that is about the most simple approach that you can take to signal processing. The processor also removes electrical noise from the signal as well as performing a number of other functions.

Question (Mr. Lagin): Did you try any pattern recognition schemes for detection of dings, cracks, or grooves?

Answer (Mr. Weismantel): Yes, although we are not applying these. Again, it is a situation where the people in the laboratory have developed some proficiency, and are trying to transmit some of that knowledge to people who might not be as flexible as the laboratory people. We are moving in that direction, and it seems to be entirely possible, although what I say has not really been totally proven.

Question (Mr. Lagin): The signal which you actually process, is it like a signal off a strip chart recorder?

Answer (Mr. Weismantel): No. It is the signal sensed by the probe that is passed through the flaw detector and then processed before it goes to both the oscilloscope and the strip chart recorder.

Question (Mr. Lagin): But, it is quite possible to use the signal processing scheme on a signal in the recorder?

Answer (Mr. Weismantel): Yes. I do not think you have as big an advantage in doing that, but yes, you could do that. We also have a switch which allows the signal processor to be switched in and out of the system. This is especially valuable if you are doing any analysis work where the operator can still use the oscilloscope to a large advantage.

The production system we have, incidentally, inspects two blade edges at a time. Both the leading and trailing blade edges are tested simultaneously. It really has two parallel systems, two signal processors, two flaw detectors, but it only has one CRT since the CRT is needed only for setup and for problem analysis. I do not know what advantage you would have in trying to process the signal after it came out of the flaw detector and oscilloscope but before going into the strip chart.

Question (Mr. Lagin): The signals that you showed, were typical signals that I would see on a strip chart recording. You say they were on an oscilloscope?

Answer (Mr. Weismantel): Those were strip chart recordings. But, that was because the signal had already been processed and had been leveled out.

Comment (Mr. Lagin): As the strip chart recording is progressing in time, you obtain a very sharp signal over a small amount of time on a defect. For a groove, it would be a slower type signal and you could perform image processing techniques on a signal like that.

Answer (Mr. Weismantel): Yes. I am not saying you cannot do that. The problem you have is that the response from some flaws can resemble the response of a groove or notch or ding, except that they might move in one direction or the other as far as their first movement is concerned. Not all responses start out in a positive direction, but the motion seems to be related to the character of what you are encountering.

Question (Mr. Houserman): The graphs you presented on detectability, were the statistics gathered from a production type operation?

Answer (Mr. Weismantel): Yes.

Question (Mr. Houserman): With the people that typically do the measurement?

Answer (Mr. Weismantel): Yes.

Question (Mr. Houserman): Secondly, would the data show that with signal processing you are getting more false alarms?

Answer (Mr. Weismantel): No, actually we are getting less. We delayed the introduction of the process to production until we had the signal processor, because during the time we were initially looking at this problem, we recognized the very high rate of false encounters that we were having. At one time without the signal processor, false signal alarms were encountered on approximately 10 percent of the parts processed. With the signal processor it is about 1 percent, and we think we have a better product.

Question (Mr. Denton): Looking at the data on this strip chart, it appears your

signal processor is really a resistor and capacitor differentiator. Is that true?

Answer (Mr. Weismantel): Not entirely.

Question (Mr. Brown): The curve that you showed flattened off on the right side. Did you increase the size of the crack? If your crack was several inches longer, a foot longer, does it drop off?

Answer (Mr. Weismantel): Not that I know of. But, since we have not had any cracks that are that long, I do not have data to show that.





## DEVELOPMENT OF NON-FERROUS CONDUCTIVITY STANDARDS AT BOEING

Art Jones

Boeing Aerospace Company  
Seattle, WA 98124

### 1. General

The need to verify the accuracy of eddy current meter readings which are used to determine the physical characteristics of non-ferrous alloys by measuring their electrical conductivity is fully accepted by industry, both manufacturers and users. The eddy current meters, therefore, must be accuracy certified by means of NBS<sup>1</sup> traceable conductivity standards for the readings to be both reliable and repeatable. Figure 1 shows a typical graph of tensile strength vs. %IACS (conductivity) for aluminum. To calibrate and accurately

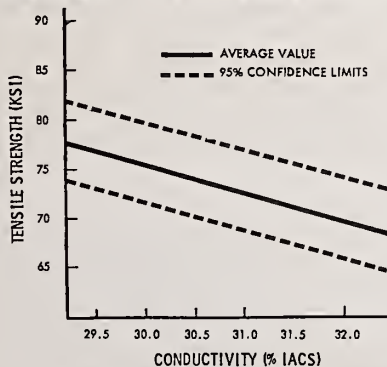

Figure 1. GENERAL RELATION BETWEEN TENSILE STRENGTH AND EDDY CURRENT CONDUCTIVITY MEASUREMENTS OF 2024-T4 ALUMINUM

certify these eddy current meters, sometimes called conductivity meters, the Boeing Company embarked upon a research and development program in 1966 to produce their own NBS traceable non-ferrous conductivity standards, since none were commercially available at that time. Also, NBS was engaged in providing only commercial copper conductivity standards at that time so it was necessary for Boeing to obtain indirect traceability by means of dimensional, resistance, and temperature standards. All of these NBS traceable standards were available at the Boeing Metrology Laboratory (BML) in Seattle, WA.

Figure 2 shows the chain of traceability to NBS from dimensional, resistance, and temperature standards.

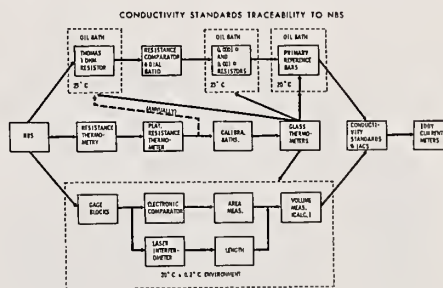

Figure 2.

### 2. Definition of %IACS

The accepted definition of commercially pure copper as stated in NBS Copper Wire Tables #31 is: a copper rod, one meter long having a uniform cross-section of one sq. mm and a resistance of 1/58 ohm at 20 °C is 100 percent International Annealed Copper Standard, or 100 %IACS. Using this as a reference then, all other nonferrous metals can have their conductivities determined relative to the hypothetical 100 %IACS value. By using the formula

$$\rho = \frac{RA}{L}$$

where:  $\rho$  = volume resistivity, in ohm cm<sup>2</sup> per cm,

<sup>1</sup>The National Bureau of Standards, U.S. Department of Commerce.

R = resistance in ohms at 20 °C of a particular length of uniformly dimensioned non-ferrous metal,

A = the cross-sectional area in square centimeters, and

L = the length being measured, for the resistance R, in centimeters

we can solve for volume resistivity. Converting the area and length to microhm centimeters, and using the definition for 100 %IACS above, we get,

$$\%IACS_{unk} = \frac{172.41 \text{ (a constant)}}{\text{volume resistivity (in microhm centimeters)}}$$

This is the general equation for finding the relative conductivity in %IACS for all non-ferrous metals from their dimensions and resistance at 20 °C.

### 3. Historical

The first use of an A-C probe coil method to measure the electrical conductivity of non-ferrous metals was made in 1939 by German industry. Subsequent improvements in lift-off and sensitivity increased both repeatability and accuracy so that the eddy current meter finally came into its own as an important non-destructive testing tool in the early 1960's. The sorting of known non-ferrous alloys, mostly aluminum, and the verification of their proper heat treatment was now possible with speed and with moderate accuracy. Unknown alloys might have to be verified by spectroscopic means because of the overlap in conductivity values between heat-treated alloys of one composition and nonheat-treated alloys of a different composition. Once the alloy was properly identified, eddy current testing could take over the task of determining the correctness of heat treatment.

Boeing first used eddy current meters for crack detection in the late 1950's. However, it was not until heat-treat identification of special alloy hydraulic fittings, called "B nuts", was urgently required in 1962 because of stress corrosion problems that we began to use eddy current meters for heat-treat identification of aluminum alloys. One such meter was a Magnaflux ED-500 which required the use of curves for conductivity values. See

figure 3 for a typical indirect reading type eddy current meter. Traceability to



Figure 3. Indirect reading type eddy current meter.

NBS or any other primary standard was not available at this time. Direct reading eddy current meters were employed later on (except on "B nuts") when conductivity standards covering the %IACS span of interest, usually aluminum, were made available. Calibration of these meters with only "end of scale" conductivity standards can result in large mid-scale errors. The two standards usually provided on direct reading eddy current meters claim neither accuracy nor traceability. See figure 4 for a direct reading type eddy current meter and a set of

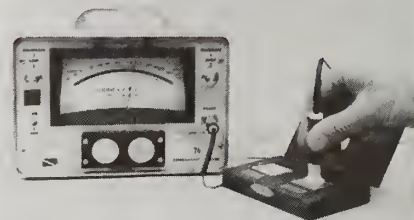

Figure 4. Direct reading type eddy current meter.

secondary conductivity standards. In late 1974, I received a letter from Hawker-Siddeley Aviation Ltd. of England indicating a 2 percent IACS difference between U.S. and French Aerospatiale standards of conductivity. On the national scene, I have witnessed differences of nearly 1 percent IACS between Boeing secondary standards and those of other U.S. manu-



facturers. Both of these types of discrepancies are intolerable because of the possibility of allowing improperly heat treated metals to be used in aircraft structures with the possibility of dangerous or fatal consequences. Figure 5 shows three sets of Boeing non-ferrous conductivity standards in carrying cases for 2,3, or 8 standards.

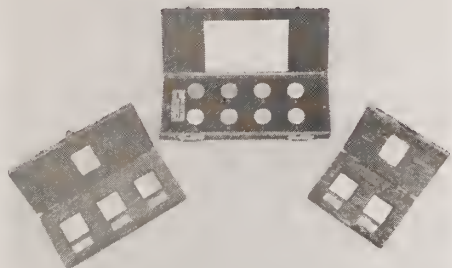

Figure 5. Three sets of Boeing non-ferrous secondary conductivity standards.

#### 4. Initial Standards Requirements

The need to make rapid non-destructive tests on incoming non-ferrous material has become increasingly important because incorrectly heat-treated alloys can fail in service and have even been suspect in some collapsed aircraft nose wheel accidents in the late 1950's. In order to insure the accuracy necessary to properly categorize both the raw stock and finished material, BML was assigned the task of producing accurate non-ferrous conductivity standards which had traceability to NBS.

#### 5. Preliminary Steps

The first involvement with eddy current conductivity standards at Boeing Metrology Labs came in 1966, when personnel of the Boeing Airplane Division (now the Boeing Commercial Airplane Company) brought some 1 in x 44 in x 1/8 in aluminum bars of various alloys to the primary standards laboratory to be measured. These bars were produced as a result of the requirements of the MIL-A-22771B government specifications on aluminum forgings. A somewhat crude measurement, using L&N List No. 4308

current and potential clamps, was made with an estimated accuracy of about 2 percent of reading at the normal lab temperature of  $23\text{ }^{\circ}\text{C} \pm 1^{\circ}$ . Dimensional area measurements and the spacing between the inner potential clamps were made by the Physical-Mechanical Section of BML. A laser interferometer was used for measuring the distance between the two inner clamp marks. The indeterminate position of these marks is why the accuracy was relatively poor. Later, length measurements made were far more accurate and used a laser to measure the distance between two very thin scratch marks on a soft aluminum bar. All later dimensional measurements were made at  $20\text{ }^{\circ}\text{C} \pm 0.5\text{ }^{\circ}\text{C}$ . Figure 6 shows the method used for thickness measurement, and figure 7 shows the laser interferometer method for determining the effective length.



Figure 6. Thickness measurement.



Figure 7. Laser interferometer length measurement.

The resistance measurement was made using an L&N six dial double ratio set, an adjustable reversible, direct current source, a sensitive null detector and any

one of three NBS traceable shunts: 0.01, 0.001, or 0.0001 ohm as required. Figure 8 shows these shunts in their oil bath. A separate, stirred, temperature-controlled shunt oil bath, a double ratio set, and a specially designed primary standards conductivity bar oil bath were used for resistance measurement. The latter oil bath was developed at a later date (approximately 1967) as part of the

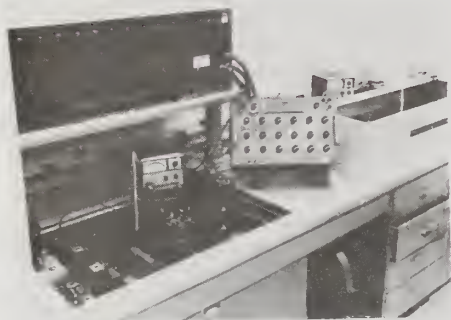

Figure 8. Precision shunts in stirred oil bath with 6 dial double ratio set.

overall research and development program to produce traceable primary standards reference conductivity bars. Figure 9 shows the conductivity bar



Figure 9. D-C primary bar calibration facility oil bath.

DC calibration fixture on a rack above its oil bath, ready for a primary bar to be inserted in place. Figure 10 shows current and potential connection details with a primary bar in normal position.

## 6. Primary Standard Bars

To provide the required accuracy for working standards of conductivity, it was first necessary to fabricate and certify primary bars from the best possible commercially available materials using both known and newly developed techniques. Copper, aluminum, bronze and titanium sheet stock 0.25 in thick approximately 2.0 in wide and 60 in long was cut and carefully fabricated using as reference

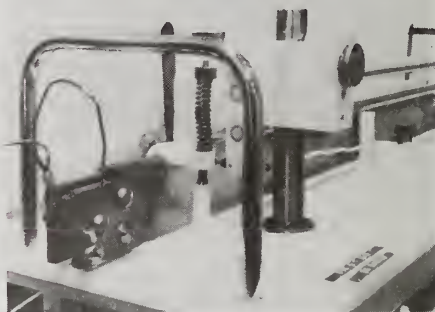

Figure 10. Current and potential connection details.

the ASTM Description B193 method for volume resistivity. This is an absolute method utilizing dimensions, resistance, and temperature for determining volume resistivity. Figure 11 shows 18 of the 19 primary standards conductivity bars in the shallow transfer oil bath. The lid is removed to show the bars in place. This bath is used for 100 kHz calibration of secondary standards which is described later on in this paper.



Figure 11. Primary standards conductivity bars in shallow oil bath.



## 7. Primary Conductivity Bar Stability

When the eight primary conductivity bars were constructed in 1966, it was envisioned at that time that there could be small but perhaps significant alterations in the initial values due to dimensional variations caused by solid state changes. Additionally, the resistivity of some of the alloys could also vary due to microstructural changes. Errors such as grain direction and stratification, which was discussed in ISA paper 70-613, "Error Analysis of Non-Ferrous Conductivity Standards," could change in value with time and also cause some change in the certified bar values. These latter two errors were not reverified since the original data was taken, but care was taken in the selection and fabrication of the newest bars to minimize these effects. In order to determine what parameters had changed in the bars themselves and to decide how much effect these changes had on the certified conductivity values, it was necessary to measure all of the bars again both dimensionally and electrically under the same tightly controlled conditions as in the original calibration.

The following table 1 shows the changes in the dimensional and electrical values of the original eight primary bars and the change in the individual certified values over an eight year period from 1967 to 1975. The %IACS changes in the table are derived from differences between the original 1967 DC values of conductivity (using resistance in ohms, length in centimeters and area in square centimeters) and the 1975 values of conductivity which include grain direction and stratification corrections. Thus it is an overall view of changes in certified values. Other comparisons are made later on using uncorrected data.

## 8. Analysis of Changes

If we discount the uncertainties for the moment and try to determine the combined effects of area and resistance changes on conductivity in %IACS, we can see that if

$$\%IACS = \frac{172.41 L}{RA},$$

the resulting conductivity values should change inversely as the area and

Table 1

Material (alloy)	Area Change	Res. Change (DC)	8 Yr. Certified Value %IACS Changes
Copper	+0.127%	-0.055%	-0.080
Al. 1100F	-0.023 <sub>4</sub>	-0.098	-0.003
Al. 6061	-0.029 <sub>3</sub>	-0.106	-0.032
Al. 5052-0	+0.005 <sub>0</sub>	-0.044	-0.012
Al. 2024T4	+0.094 <sub>0</sub>	0.000	-0.149
Al. 2024 <sup>a</sup>	-0.005 <sub>0</sub>	+0.105	-0.072
Yel. Brass	+0.017 <sub>4</sub>	-0.103	+0.018
Titanium <sup>b</sup>			

<sup>a</sup>2024T351

<sup>b</sup>See 75-17L for titanium. Original bar retired-too thin.

NOTE: Area change values have an uncertainty of  $\pm 0.08\%$ , the resistance change values have an uncertainty of  $<\pm 0.01\%$  and the %IACS value changes, are calculated from both of the above plus temperature uncertainty and have an uncertainty of  $<\pm 0.1\%$ .



resistance. Or, stated another way, as the area or resistance increases, the %IACS should get smaller, all other terms remaining constant. If the value of either A or R increases at the same rate that the other decreases, the effect of both tend to cancel. An analysis of each bar follows in table 2.

### 9. Grain Direction and Stratification Effect

One reason for the above discrepancy is that a change was made in the aluminum set values to correct for grain direction and stratification. Since the original bars were cut with the grain direction (or direction of roll), the %IACS values tend to be higher than actual because of the lower resistance values when measured along that axis. Tests were performed to determine the magnitude of this effect. The corrections were calculated to be half of the difference between "with grain" and "across grain" values for eddy current measurement purposes. Since the original values of conductivity were too high, the corrective action was to recertify the %IACS values to a proper lower figure. Thus, all of the five aluminum alloys had from -0.02 percent to -0.12 percent IACS change added algebraically to the most recently calculated %IACS figures depending on the particular alloy. Stratification corrections were generally about one-third the value of the grain direction corrections and, except in the case of aluminum 1100F, had the opposite sign, tending to make %IACS figures higher in conductivity values. Taking all of these factors into consideration, we then find the following result in table 3a and 3b.

### 10. Comparison of Original and Latest Data

The matching of magnitudes and direction now indicates the actual changes occurring in the primary bars. A comparison of the uncorrected bar changes are the changes due only to the area and resistance changes follows in table 4.

It is significant that the errors due to grain direction and stratification have changed originally assigned values by as much as 0.12 %IACS. These corrections were not obtainable at the start of the program, but are now figured into the values of the primary bars adding to the credibility of the certified secondary standard values. More will be said about secondary standard certification methods later in this paper.

### 11. Additional Primary Bars (75-17 L)

In 1968, a review of the Boeing Company's requirements resulted in adding eight additional primary standard conductivity bars to the original eight bars. (The original thin titanium bar was not retired until 1970.) Most of these new bars were in the lower end of the conductivity spectrum because of the large amount of research being devoted to titanium fabrication in the SST (supersonic transport) project at that time. Three bronze bars nominally 6.8<sub>9</sub>, 8.7<sub>4</sub>, and 16.6<sub>4</sub> %IACS plus five titanium bars nominally 0.97<sub>3</sub>, 1.00<sub>8</sub>, 1.05<sub>6</sub>, 1.23<sub>5</sub>, and 3.62<sub>4</sub> %IACS were processed and calibrated as described in ISA paper 68-550. A similar error analysis was performed on the 75-17L bars and showed a maximum Δ% of %IACS value of -1.14<sub>0</sub>.

Table 2

Material (alloy)	Area. Res. Calc. Change	8 Yr. Cert. Value Change
Copper	Lower	Lower
Al. 1100F	Higher	Lower <sup>a</sup>
Al. 6061	Higher	Lower <sup>a</sup>
Al. 5052-0	Higher	Lower <sup>a</sup>
Al. 2024T4	Lower	Lower
Al. 2024 351	Lower	Lower
Yel. Brass	Higher	Higher

<sup>a</sup>Opposite effect than predicted.

Table 3a

Pri. Bar Material	%IACS AC <sup>a</sup>	%IACS corrections	%IACS DC(new)
Copper	101.2 <sub>1</sub>	0(est.)	101.2 <sub>1</sub>
Al. 1100F	60.16 <sub>8</sub>	-0.06 <sub>2</sub>	60.23 <sub>0</sub>
Al. 6061	41.57 <sub>4</sub>	-0.06 <sub>9</sub>	41.64 <sub>3</sub>
Al. 5052-0	35.52 <sub>5</sub>	-0.02 <sub>7</sub>	35.54 <sub>6</sub>
Al. 2024-T4	30.60 <sub>4</sub>	-0.11 <sub>6</sub>	30.72 <sub>0</sub>
Al. 2024T351	29.83 <sub>5</sub>	-0.03 <sub>7</sub>	29.87 <sub>2</sub>
Yel. Brass	27.24 <sub>6</sub>	0(est.)	27.24 <sub>6</sub>

<sup>a</sup>%IACS corrected values are certified from 60 kHz to 200 kHz after adjusting for grain direction and stratification effects.

Table 3b

Pri. Bar Material	%IACS DC (Orig)	%IACS DC Diff.
Copper	101.2 <sub>9</sub>	-0.08
Al. 1100F	60.17 <sub>1</sub>	+0.06
Al. 6061	41.60 <sub>5</sub>	+0.04
Al. 5052-0	35.53 <sub>1</sub>	+0.02
Al. 2024-T4	30.75 <sub>2</sub>	-0.03
Al. 2024T351	29.88 <sub>6</sub>	-0.01
Yel. Brass	27.23 <sub>4</sub>	+0.01

Table 4

Pri. Bar Material	(Table 3) Uncorr. Changes	(Table 1) Area Res. Changes	Diff. %IACS <sup>a</sup>
Copper	-0.08%IACS	+0.07%IACS	0.01
Al. 1100F	+0.06	-0.12	0.06
Al. 6061	+0.04	-0.13	0.09
Al. 5052-0	+0.02	-0.04	0.02
Al. 2024 T4	-0.03	+0.09	0.06
Al. 2024T351	-0.01	+0.10	0.09
Yel. Brass	+0.01	-0.09	0.08

<sup>a</sup>Evidence of the repeatability of readings taken with the facility.

## 12. Filling in Some Gaps in %IACS Standards Values

Even though the low end of the conductivity spectrum seems to be quite complete, especially in the titanium range, it was necessary to add a new bar so that eddy current meters having a range of 0 to 3.5 %IACS could have a meaningful calibration. A review of the titanium standards shows the highest value to the 3.6 %IACS which is off scale, and the next lower value is 1.2 %IACS which is too far down scale to be significant when used by itself or with lower values in %IACS. A new bar having a value of 3.37 %IACS has been fabricated and put into the set of 19 total located in the transfer oil bath previously shown in figure 11.

The portion of the aluminum conductivity spectrum existing between the 41.6 %IACS and 60.2 %IACS standards required at least 2 more standards to produce better results for eddy current meter calibration and for curve-fitting the data better as explained later on in this paper. Unfortunately, although two different alloys of aluminum, 6061-0 and 2024-0 were processed, the values turned out to be within about 0.2 %IACS of each other at about 47.5 %IACS rather than the nominal 5 percent difference expected from table of physical properties used for the selection process.

As a result of previous experience and analysis, both aluminum bars were selected in the -0 condition for least stratification and were then cut at 45° to the direction of roll, effectively negating the effect of grain direction. This means that the AC values assigned to each bar will be the same as the DC values, and no corrections are required for these 2 potential sources of error in the transfer

from DC to AC values. The fourth area which required at least one additional primary standards bar was between the 60.2 and 101.1 %IACS standards. A conducting bronze bar was fabricated in the same manner as previously described in the references, and now gives an additional certified conductivity value in that area at 85.39 %IACS. None of the 4 new bars were tested for permeability, based on the results of the original tests on the first 16 bars, which showed negligible effects from permeability, except copper nickel bronze.

The results of the calibration of the four new non-ferrous conductivity bars are as follows in table 5.

## 13. Improved Accuracy Transfer to Secondary Standards

The original method developed to determine values of secondary conductivity standards utilized an a-c impedance bridge, modified to include a guard circuit, lift-off compensation and various probe compensation capacitor settings. The frequency was fixed at 100 kHz  $\pm$  1.0 Hz and power entered the bridge circuit at a voltage somewhat less than 10 volts rms. An a-c null detector indicated the bridge balance condition and a Wagner ground was included for precise and repeatable detector balance. See figure 12 for the schematic of the bridge circuit.

The initial method of experimenting with slope curves in pF/%IACS values vs. %IACS, with changing probe compensation capacitance values in segmented areas and with weighted averages for determination of secondary standard conductivity values was adequate when comparing like or very close values of conductivity. It failed

Table 5

Material (alloy)	Conductivity	Temp. Coeff. of Resis/°C <sup>a</sup>
Conducting Bronze	85.39 %IACS	0.003 <sub>2</sub>
Al. 6061-0	47.64 <sub>3</sub>	0.003 <sub>2</sub>
Al. 2024-0	47.46 <sub>1</sub>	0.003 <sub>3</sub>
Titanium 55	3.37 <sub>6</sub>	0.003 <sub>6</sub>

<sup>a</sup>The temperature coefficient of resistivity per °C is accurate to  $\pm 0.0002$  between 15 and 35 °C also called TCF or temperature correction factor.



to deliver the expected accuracy, however, when the known values were over two percent different in %IACS from the reference standard values. Deviations were discovered when one primary standard bar was used to verify another primary standard bar several %IACS different from the first. The ensuing investigation showed that the entire premise on which transfer of primary bar accuracy to secondary standards was based, with allowance for bridge errors, was somewhat less accurate when the two standards, reference and unknown, differed by more than 2 percent. With some of the secondary standard nominal values several percent away from closest reference standard, certifications within  $\pm 0.35$  %IACS of the stated values required re-examination.

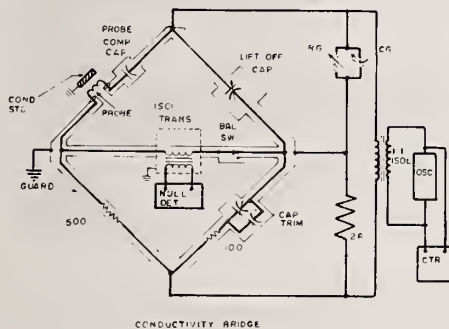

Figure 12.

#### 14. Curve Fitting Method

After analyzing several different approaches, it was decided to segment the conductivity spectrum into six parts and use curve fitting techniques, with an H-P 65 to determine the unknown values based

only on the pF values at balance. Only one fixed probe compensation setting was used. Corrections to each segment, depended upon how close to the primary standards values the unknown standard was and corrections were automatically applied. The results were well within our anticipated values of accuracy when calibrating one primary standard against any other primary standard in a particular segment.

The six segments and the method of curve fitting applied is shown below.

#### 15. Development of Curve Fitting Method Details

Interpolation formulas were derived using curve fitting techniques based, in part, on programs in the Stat. Pac 1 of the Hewlett Packard HP-65 programmable calculator. Since it had been previously observed that if the bridge readings in pF were plotted with the %IACS on log-log graph paper, the resulting points were nearly in a straight line; logarithms of the bridge readings and %IACS values were used in the curve fitting process. An attempt to determine a single overall formula for the entire range from 0.96 percent to 101.2 %IACS showed that errors would be too large. Therefore, the %IACS values were divided into segments as follows:

- (1) 0.96% to 1.23%
- (2) 1.2% to 3.6%
- (3) 6.8% to 27.2%
- (4) 27.2% to 41.6%
- (5) 35.6% to 47%
- (6) 41.6% to 101.2%.

Segment No.	Conductivity Limits %IACS	Curve Fitting Method
1	0.96 to 1.23	Mod. Pwr. Curve
2	1.2 to 3.6	Mod. Pwr. Curve
3	6.8 to 27.2	Linear Regression
4	27.2 to 41.6	Mod. Pwr. Curve
5	35.6 to 47	Mod. Pwr. Curve
6	41.6 to 101.2	Mod. Pwr. Curve

A different formula was derived for each segment. Linear regression proved to give an acceptable fit for the data for segment (3); the other segments were curve fitted using a modification of the power curve. These formulas, as applied here, are as follows:

Linear regression:

$$\log \%IACS = A_0 + A_1 \log pF$$

Power curve (modified):

$$\log \%IACS - \left[ \frac{\log pF}{a} \right] \frac{1}{b}$$

where  $A_0$ ,  $A_1$ ,  $a$ , and  $b$  are coefficients determined by the curve fitting process and "pF" is the corrected bridge reading in pF.

#### 16. Programming the Calculator

These coefficients are then incorporated into HP 65 programs--one for each segment--which are used to determine conductivity of standards tested. In some cases, additional corrections are incorporated to reduce errors at points on the interpolation curve close to the conductivities of the standard bars. Since the %IACS is determined by the formulas in terms of only one variable, the bridge reading in pF, no "standard reading", as such, is necessary. In practice, however, a bridge balance is made for a standard close (in %IACS) to the value of the "unknown" to account for any drift in the capacitance elements in the bridge. The difference between the standard reading taken at that time and the standard reading used to determine the interpolation curve is then used to shift the unknown reading by a like amount before applying the interpolation formula.

The HP-65 curve fitting programs used also provide an additional parameter  $r^2$ , or "goodness of fit." It was found that this number must be quite close to 1; 0.999 or greater in most cases to give satisfactory results. This is probably due mostly to the scale compressing effects of logarithms.

#### 17. Secondary Conductivity Standard Calibration Improvements

A new oscillator with improved output voltage and better stability characteristics which can now deliver a steady 10 volts rms to the bridge circuit at 100 kHz  $\pm$  1 Hz has replaced the original oscillator. The results have been much more consistent readings from the primary standards bar as well as a slight improvement in detector sensitivity due to somewhat higher voltage. See figure 13 for a view of the probe and the bridge circuit control console.

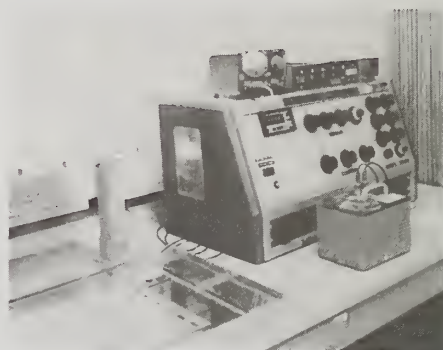

Figure 13. 100 kHz conductivity transfer bridge and probe.

When coupled with the new curve fitting techniques, the accuracy improvement in actual bridge reading values reduces the uncertainty of %IACS accuracy limits from an estimated +0.15 percent to approximately +0.07 %IACS. Adding this uncertainty to the +0.2 %IACS, which is now thought to be quite conservative based on historical performance evaluation, we feel confident of the stated  $\pm 0.35$  %IACS, or 1 percent of reading accuracies, whichever is less, assigned to secondary non-ferrous conductivity standards produced by the Boeing Metrology Laboratories. Figure 5 showed some types of secondary standards in their containers after being calibrated against the primary bars in the transfer oil bath.

#### 18. How Good Are Eddy Current Meter Standards?

From what has been discussed previously, it can be seen that unless some

unknown factor has not been considered, the Boeing secondary non-ferrous conductivity standards which are categorized to be working standards for conductivity, are well within the  $\pm 0.35$  %IACS or 1 percent of value uncertainty assigned to them. Periodic recalibration and recertification of the Boeing primary standard bars and the annual in-oil recertification of the secondary standards using the 100 kHz conductivity bridge transfer oil bath shown in figure 13 will keep the secondary standards within the assigned accuracy limits.

It has been Boeing policy to resurface secondary standards which are received for recalibration in such condition that lift-off errors can exist as a result of excessive wear. Some slight drift characteristics have been observed in secondary standards over the 10 year period, but recertification keeps them well within their uncertainty limits for the one calendar year cycle assigned to them in-house. Commercial customers usually observe longer cycles to suit their needs or internal cycle periods.

Using these secondary conductivity standards serves to guarantee the accuracy of direct reading eddy current meters by verifying the scale tracking in the area of interest. Although, for example, several scale points in the most frequently used aluminum conductivity range, 28 to 60 %IACS, are compared to the standards in that range, this does not assure the accuracy of scale indication outside of that range. If the entire scale is to be utilized from the low or titanium range up through copper, certified secondary conductivity standards covering the entire range from 1 to 100 %IACS should be used. Without such standards the indicated values of either direct or indirect eddy current meters are questionable.

Several manufacturers are now in the business of providing certified conductivity standards for use with eddy current meters. A few of the types produced by the Boeing Company were shown in figure 5. Several other configurations have been made to satisfy internal requirements, but basically the accuracies and non-ferrous materials are the same as with the standards forms.

#### Error Analysis

##### Primary Standard Bars (used to calibrate secondary coupons)

<u>Component</u>	<u>Max Expected Error</u>	<u>Remarks</u>
DC Ref. Resistor	$\pm 0.005\%$	Traceable to NBS Thomas 1 ohm
Double Ratio Set	$\pm 0.001\%$	
Galvo Readability	$\pm 0.01\%$	At maximum sensitivity
Thermometer	$\pm 0.012\%$	19° to 21 °C
Thermocouples in bath	$\pm 0.0016\%$	Galvo reads opposing T.C.
DC Sys. Instability	$\pm 0.04\%$	Temperature of bath oil
Conductivity Material	$\pm 0.054\%$	Non-homogeneity
Stratification Error	NA	Corrections Made
Grain Direction Error	NA	Corrections Made
Repeatability	$< \pm 0.1\%$	
Total RSS error = $\pm 0.12\%$ of reading in ohm cm @ 20 °C (cert. to $\pm 0.20$ % IACS or 0.5% of reading, whichever is less at 20 °C)		

##### Secondary Standard Coupons

<u>Component</u>	<u>Max Expected Error</u>
Primary bar basic error	$\pm 0.12\%$ of reading
100 kHz bridge error	$< \pm 0.10\%$ of reading
Probe error (position)	$< \pm 0.10\%$ of reading
Curve fitting error	$\pm 0.05\%$ of reading
Aging and wear (1 yr. cycle)	$\pm 0.10\%$ of reading (max.)
Temperature uncertainty	$\pm 0.05\%$ of reading
Total RSS error = $\pm 0.22\%$ of reading (Cert. to $\pm 0.35$ %IACS or 1% of reading, whichever is less at 20 °C)	



## 19. Conclusions

The preceding error analysis indicates that the certified accuracies assigned to the primary standard conductivity bars for a 2 year re-certification cycle and the secondary standards for a 1 year cycle are reasonable. Coupled with this, our experience has shown minimal differences in the primary bar values due to changes in solid state structure and other aging factors.

The fact that all the measurements are basic parameters which have been in existence for decades gives us confidence in our ability to provide indirect traceability to NBS basic standards of resistance, length and temperature. Adherence to good machine shop practices, careful screening of materials, utilization of the latest measurement techniques and, above all, careful attention to minute details in both constructing and measuring these standards has incorporated a high order of built-in accuracy.

At present, NBS in Gaithersburg, Maryland, is preparing to construct non-ferrous conductivity standards. They indicate that comparisons with these standards are still about a year away. Discussion with NBS personnel indicate that an approach similar to the one used at Boeing will be used by them both in construction and in measurement of their conductivity standards.

The only additional research proposed in this field at Boeing is to build about four more primary standards bars this year to increase the accuracy of the curve fitting technique in some of the segments where the spread between any two of the primary bars is larger than deemed suitable.

## References

- [1] Jones, A. R., Bulk Conductivity Measurement Standards, presented at ASTM Annual Meeting, Boston, Mass., June 1967.
- [2] Jones, A. R., Non-Ferrous Conductivity Standards, presented at ISA Annual Meeting, New York City, October, 1968 (68-550).

- [3] Jones, A. R., Error Analysis of Non-Ferrous Conductivity Standards, presented at the ISA International Conference and Exhibit, Philadelphia, Pennsylvania, October 1970 (70-613).
- [4] The Boeing Company D6-4813, Material/Temper Identification - Aluminum Alloys.
- [5] ASTM Designation B193-65, Resistivity of Electrical Conductor Materials (Standard Method of Test).
- [6] NBS Copper Wire Table, No. 31, p. 75.
- [7] Libby, H. L., Introduction to Electromagnetic Nondestructive Test Methods.
- [8] Jones, A. R., Non-Ferrous Conductivity Standards - A Ten Year Review, presented at ISA International Conference and Exhibit, Houston, Texas, October, 1976.
- [9] Jones, A. R., Eddy Current Meter Standards, How Good Are They?, presented at ASNT Spring Conference, Phoenix, Arizona, March, 1977.

## Discussion

Question (Dr. Mc Master): I have found there are measurable eddy currents up to three times the diameter of the coil. Every time you measure something smaller than that, you are clipping the corners. Have you found much error due to the ratio of coil diameters, or have all coil diameters you have tested been so small that you are nowhere near the sample edge?

(Mr. Jones): You are talking about edge effects?

(Dr. Mc Master): Yes.

Answer (Mr. Jones): We measure in the center of the secondary standards with a small coil and try to get somewhere near the middle of the primary bar. Also, we always measure on the same spot on the primary bar.

## NBS EDDY CURRENT STANDARDS PROGRAM

George M. Free

Electrical Measurements and Standards Division  
National Bureau of Standards  
Washington, DC 20234

### 1. Introduction

The present goals of the NBS eddy current program are twofold: the creation of an electrical conductivity calibration service for non-ferrous metal standards, and the development of non-ferrous metal Standard Reference Materials to be issued as conductivity standards. The calibration service will provide measurements of the electrical conductivity of standards sent to NBS by industry and issue reports on these standards. The Standard Reference Material Program will make available to industry electrical conductivity standards suitable for use in calibrating eddy current instrumentation.

In order to establish the NBS electrical conductivity calibration service instrumentation and methodology must be developed in several areas [1]<sup>1</sup>. Primary conductivity standards consisting of long metal bars are being developed which will be measured using dc techniques to determine the conductivity of the material. Using eddy-current techniques, customer conductivity samples will then be compared with the primary standards to arrive at the conductivity of the sample.

Work has been developing along two lines, design and construction of dc measurement apparatus, and design and construction of ac measurement apparatus. These two measurement systems will be discussed in more detail.

### 2. The DC System

Since eddy current measurements are made at a point, or over a small area, the NBS dc measurement is designed to determine conductivity at a specific point

From the relation  $\bar{J} = \sigma \bar{E}$  in which  $\bar{J}$  is the current density,  $\sigma$  the electrical conductivity and  $\bar{E}$  the electric field, the conductivity of a uniform bar may be written

$$\sigma = \frac{L}{RA}$$

A = cross sectional area of material  
L = distance between potential contacts  
R = resistance

if R and A are considered to be average values over the length L. If the bar is only slightly irregular, this relation will hold if  $\sigma$ ,  $dR/dx$ , and A are considered to be slowly varying functions over the length of the bar.

$$\sigma = \frac{1/A}{1 \frac{dR}{dx}} = \frac{1}{A \frac{dR}{dx}}$$

where A is the cross-sectional area at a specific point on the bar and  $dR/dx$  is the slope of the resistance vs. length curve at a specific point. In approaching the determination of conductivity in this manner, two sets of information are necessary. A mapping of the cross-sectional area along the length of the bar and a mapping of the resistance of the bar. The two sets of data will then appear as in figure 1.

To determine  $\sigma$ , the slope of the resistance curve at a point will be calculated and the area of the bar at that point will be determined. Dimensional measurements of the bar will be done by another group within NBS. The dc measurement of resistance will be done using a current comparator as described below.

The operation of the current comparator is shown in figure 2. A current is

<sup>1</sup>Figures in brackets indicate the literature references at the end of this paper.



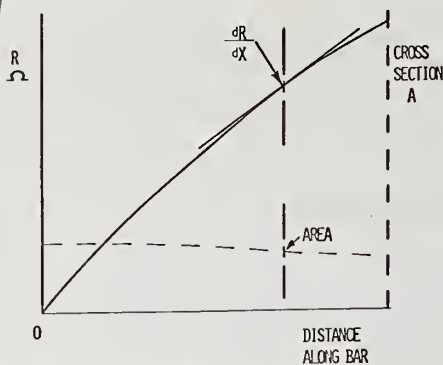

Figure 1. Determination of  $(dR/dx)$  and (A) at a specific cross-section of metal bar.

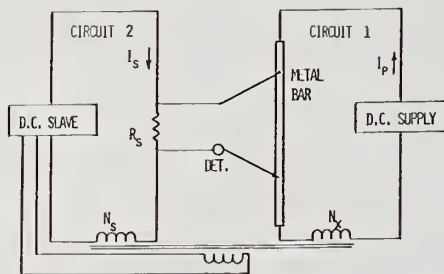

Figure 2. Current comparator schematic with metal bar in place.

established in circuit (1) by the main power supply. The primary and secondary currents separately pass through a number of turns wrapped on a common core, the turns being wound in opposition; a flux sensor detects any residual flux in the core and adjusts the slave power supply so that zero flux exists in the steady state. The  $I_x N_x = I_s N_s$ . The turns ratio  $N_s/N_x$  can also be varied to achieve a null at the detector. At the point of balance  $I_x R_x = I_s R_s$  or  $R_x = R_s N_x/N_s$ . Then the unknown resistance is known in terms of a standard and a turns ratio.

During the resistance measurement, the metal bar will rest on a modified optical bench, as in figure 3. Current will be injected at (A) and leave at (B); the potential contacts are at (1) and (2). Potential contact (1) will remain fixed while (2) will be varied along the length

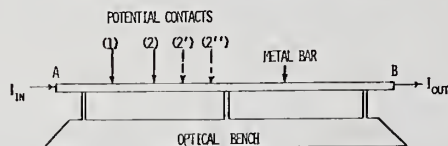

Figure 3. Motion of potential contacts along length of metal bar.

of the bar. The separation distance between potential points will be measured by a laser interferometer. Thus, a series of measurements of resistance can be made along the bar with a minimum distance of separation of 1 cm. The total length of the bar will be approximately 1.5 m with a cross-section of 50 mm x 6 mm.

The measurement will be done in an oil bath which is stable to about  $\pm 3 \times 10^{-3} \text{ }^\circ\text{C}$ . The range of temperature possible in the bath is  $18 \text{ }^\circ\text{C}$  to  $30 \text{ }^\circ\text{C}$ . With temperature,  $dR/dx$ , and cross-sectional area known, the conductivity can be calculated. The bars will then become the primary standards of conductivity at NBS.

### 3. AC System

The eddy current measurements will be done on a bridge as seen in figure 4. The major components of the bridge are the three inductive voltage dividers, a variable frequency power supply and a phase sensitive detector. The bridge is designed for use in three general ways. In the positions of the two test coils on the bridge diagram, the following may be placed:

- Coil and capacitor. Used to calibrate inductance in terms of capacitance standards.
- Two coils used to make the measurements in an absolute sense. One coil will be in air while the other coil will be placed on the metal sample.
- Two coils used to make the measurements in a relative sense. Both coils will be placed on the same piece of metal for a zero reading, then one coil will be placed on the unknown sample. The change in conductivity will be determined from the change in the bridge balance conditions.

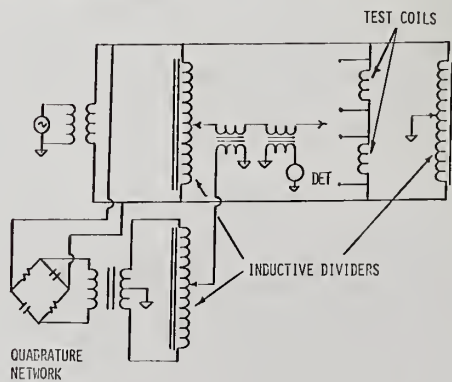

Figure 4. Eddy current bridge



The actual conductivity of an unknown will be obtained by interpolating the experimental results for measurements on two primary standards and the unknown, using primary standards having conductivities above and below the unknown.

#### 4. NBS Services

Reports on the calibration of a customer's sample are envisioned as follows. Besides a written report, a graph will be given as seen in figure 5. Conductivity will be shown as a function of frequency and as a function of temperature for a specific range of frequencies. The total uncertainty assigned to the test will be a function of the metal sample that is being calibrated, i.e., its uniformity. For a uniform metal sample the total uncertainty should be about 0.1 percent IACS.

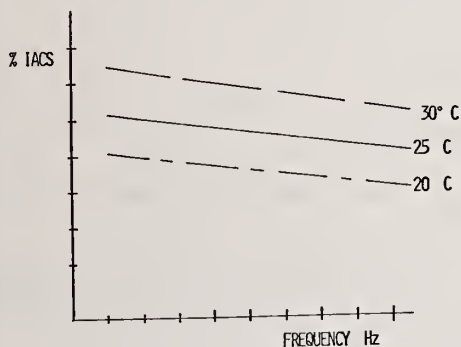

Figure 5. Information on conductivity sample to be included in test report.

Although plans for constructing the Standard Reference Materials are not yet finalized, there are several directions that could possibly be followed. First is the use of powder metallurgy or some other metallurgical technique to guarantee that the sample is indeed uniform. A calibration report as above would be issued with the sample. Another possibility is to use the most common metals and alloys for standards. If common metals are used, the need for temperature corrections would be eliminated since the metal to be tested would be at the same temperature as the standards used to calibrate the eddy current meter.

#### 5. Other Areas of Study

Coils are being constructed using the relations derived by Dodd et al. [2]. Values for the impedance of a coil on a conducting flat surface have been calculated. These results are being used to achieve optimum performance in the coils constructed, i.e., maximum sensitivity to change in conductivity and minimum change in impedance for lift-off. The relations will also be used to establish the theoretical shape of the impedance curve between points of known dc conductivity, i.e., those points for which primary standards are available. An attempt will be made to correlate measured coil parameters with the theoretical values. If the agreement between actual measured values and theoretical calculations is sufficiently close, a quasi-absolute determination of conductivity can be made.

A second experiment that has been briefly investigated but which will be pursued further is based on the theorem of Van der Pauw [3]. This relation is commonly used in semiconductor technology to determine the dc resistivity of a sample of uniform thickness.

In this theorem, the following relation is derived:

$$e^{-\pi R_1 d / \rho} + e^{-\pi R_2 d / \rho} = 1$$

Resistivity becomes a function of two resistance measurements,  $R_1$  and  $R_2$ , and a measurement of  $d$  the thickness of the sample. The advantages are obvious.

All of the above work will be directed towards the goals stated at the beginning of the paper, the establishment of precise standards of electrical conductivity which are usable by industry. The present goal of the program is to have the electrical conductivity calibration service available in the Fall of 1978. The first SRM's will be issued in 1979.

#### References

- [1] Jones, Arthur R, "Electrical Conductivity Measurement Standards," Presented at ISA Conference, Boston, 1970.

- [2] Dodd, C. V., Deeds, W. E., Luquire, J. W., Integral solutions to some eddy current problems, International Journal of Nondestructive Testing, 1, 29-90 (1969).
- [3] Van der Pauw, J. J., A method of measuring specific resistivity and Hall effect of discs of arbitrary shape, Philips Research Reports, 13, No. 1 (February 1958).

#### Discussion

Question (Mr. Wehrmeister): I am curious to know what sort of tolerances you are putting on your readings in terms of percent IACS? And what tolerance is industry working towards?

Answer (Mr. Free): In this experiment, we are hoping to achieve an uncertainty of .1 percent IACS. By tolerance, do you mean the uncertainty in measuring conductivity in a sorting operation?

Question (Mr. Wehrmeister): How accurately do they have to obtain a reading or a measurement?

Answer (Mr. Free): As I understand it, when running a characteristics test on incoming metal, it is around 4 or 5 percent.

Comment (Mr. Jones): Usually, the precision should be plus or minus .5 percent, IACS. For example, if you have an allowed band of 31-1/2 percent to 33-1/2 percent, you would have to hold that to 32 percent or 33 percent, but 15 percent would be used up in your measurement uncertainty, considering the conductivity standards being used.

On the primary bars, we try and get to .2 percent plus or minus half percent reading, whichever is less.

Comment (Mr. Lagin): One thing which I think industry would like to see come out of NBS in the future is a standard representing various radii of curvature. Usually we have to take conductivity measurements on curved surfaces, and since the probe has finite dimensions this introduces error. There is a large percentage of error when the parts have a radius of curvature of less than half an inch. The conductivity measured could be in error by as much as 10 percent.

Question (Mr. Wehrmeister): What type of geometry in test samples will you be accepting. Will they be flat, or can I send you a piece of tubing?

Answer (Mr. Free): The samples, at least to start out with, will be flat, geometrically a flat sample.

Question (Mr. Jones): When you are making your resistance measurements, what type of spacing will you have between the potential probes?

In other words, say you start near the top, do you take ten readings and the move a quarter of an inch, and then take ten more readings to get the uniformity across the width of your standard bar which you said was two inches?

Question (Mr. Free): Do you mean to get the mapping of the cross-sectional area, or the mapping of the resistance?

Answer (Mr. Jones): The mapping of the resistance.

Answer (Mr. Free): Initially, there will be two measurements.

Question (Mr. Jones): Somewhere near the middle?

Answer (Mr. Free): Two points, somewhat off center, but on either side of the center.

## ELECTROMAGNETIC THEORY AND ITS RELATIONSHIP TO STANDARDS

Arnold H. Kahn and Richard D. Spal<sup>1</sup>

Center for Materials Science  
National Measurement Laboratory  
National Bureau of Standards  
Washington, DC 20234

### 1. Introduction

The interpretation and derivation of the maximum information from electromagnetic testing and the optimum design of testing methods depends on principles found in classical electromagnetic theory. The value of an approach based, in part, on a theoretical grounding is well demonstrated in the discussion by Libby [1]<sup>2</sup>. In the development of standards, the application of theoretical analysis can be used to base the standards, at least in part, on physical laws. We hope that discussions at this meeting will suggest areas where theoretical efforts may be profitably undertaken.

As one of the NBS activities in electromagnetic NDE, we have performed analyses of the nature of eddy current distributions in the vicinity of a crack in conducting material. The purpose of these investigations is to provide predictions of the changes of signals in testing apparatus due to cracks, or alternatively to aid in the characterization of defects.

Literature searches on this subject have yielded only a few theoretical treatments of the modification of eddy currents due to the presence of defects. The treatment of Burrows [2] and Dodd, et al., [3] considers the perturbation of the eddy current pattern by an ellipsoidal inclusion. However, in this treatment the inclusion had dimensions which were small with respect to the electromagnetic skin depth. However, for greatest sensitivity of detection the frequencies must be such that the skin depth is of the same order of magnitude

as the dimensions of the obstacle. In this contribution to the Workshop, we report on calculations of the eddy current and impedance changes associated with a surface crack in a plane slab and on a cylinder. In the case of the cylinder, impedance diagrams are given, and the modifications due to the crack are demonstrated.

### 2. Crack on a Plane Slab

Our model for a crack [4] assumes that there is a long, thin gap in the conducting material. We treat the gap as preventing the flow of any normal component of electric current density. The magnetic field for which we perform the calculations is applied tangential to the surface and parallel to the crack. The geometric configuration is shown in figure 1. In the figure, the width of the crack is exaggerated so as to show the unrestricted penetration of the applied a.c. magnetic field,  $H_0 e^{-i\omega t}$ , into the crack. The lines with arrow heads indicate schematically the direction and path of the current at some instant of time. The solution to this problem is moderately difficult and much can be learned by breaking it into two component problems, the corner and the tip, as shown in figure 2. These can be solved exactly. The results may then be combined to give the results for a crack provided its depth is greater than four skin depths.

The equation to be solved is [1,4]

$$(\nabla^2 + k^2)H = 0, \quad (2.1)$$

<sup>1</sup>Department of Physics, University of Pennsylvania, Philadelphia, PA 19104.

<sup>2</sup>Figures in brackets indicate literature references at the end of this paper.



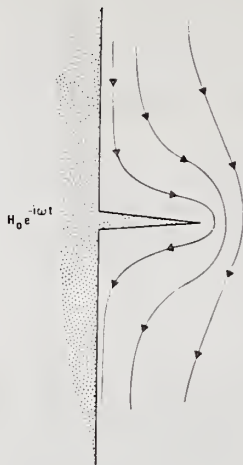

Figure 1. Schematic drawing of eddy currents in the vicinity of a surface crack in a slab of conducting material. The a.c. magnetic field applied at the surface is normal to the figure and uniform in space.

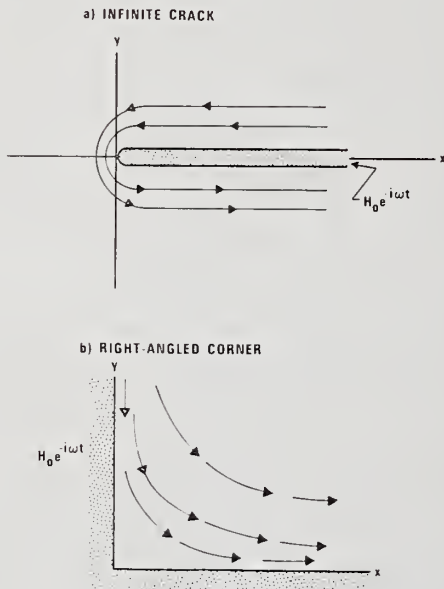

Figure 2. Two solvable problems related to the crack of figure 1. In the infinite crack, a magnetic field,  $H_0 e^{-i\omega t}$ , is present in the gap as far as the tip. In the right-angled corner problem, the field is applied to the boundary, parallel to the corner. Arrows indicate the current flow.

where the complex propagation constant,  $k$ , is

$$k = (i\omega\mu)^{1/2}. \quad (2.2)$$

In the above equations,  $H$  is the field inside the conductor,  $\sigma$  is the electrical conductivity,  $\omega$  is the angular frequency of the applied field, and  $\mu$  is the permeability of the conductor. At the surface of the material, and in the crack gap, the field must take on the value of the applied field,  $H_0 e^{-i\omega t}$ . In terms of the electromagnetic skin depth,  $\delta$ , given by

$$\delta = (2/\sigma\omega\mu)^{1/2}, \quad (2.3)$$

the propagation constant may be expressed as,

$$k = (1+i)/\delta. \quad (2.4)$$

In order to calculate changes of power dissipation and energy stored, it is not necessary to map the field; we need only know the current density at the surface, which, in turn, depends on the normal derivative of the field at the surface. The results are conveniently expressed in terms of the complex Poynting vector,

$$S = 1/2(E \times H^*),$$

where  $E$  and  $H$  are the electric and magnetic fields at the surface of the material. The real part of  $S$  gives the power dissipation per unit area and the imaginary part gives the energy stored [4,5]. (In the next case, the cylinder with a crack, the Poynting vector leads directly to the complex impedance.)

In figure 3, we show the normal component of the Poynting vector,  $S$ , as a function of distance from the tip of a deep crack. The values of  $S$  are normalized to  $S_0$ , the value appropriate to plane surface in the absence of a crack. We see that the greatest dissipation and reactance changes occur near the tip and that at a distance beyond  $1.5\delta$  from the tip fields are "back to normal." A similar situation occurs at the corner, as

is seen in figure 4. The loss at the corner vanishes, but the "range" of the corner is about  $2.5\delta$ . The losses at the

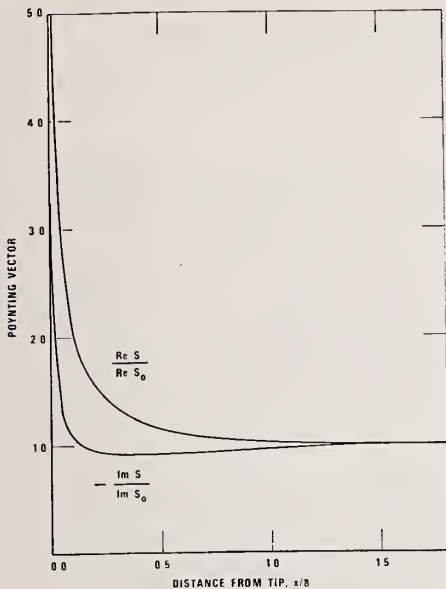

Figure 3. Plot of the normal component of the Poynting vector on the surface of an infinite crack at a distance,  $x$ , from the tip. In the plot the Poynting vector is normalized to  $Re S_0$ , where  $S_0$  is the Poynting vector for plane surface in the absence of a crack. Distance is in units of  $\delta$ , the skin depth.

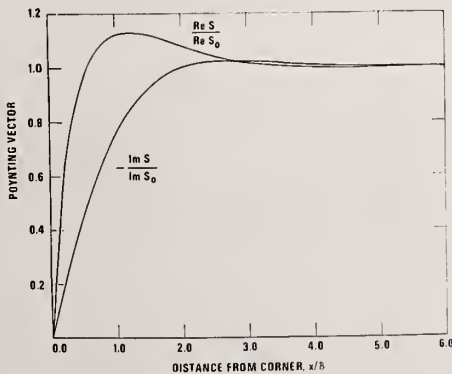

Figure 4. Plot of the normalized Poynting vector,  $S'$ , on the surface of a square corner, at a distance,  $x$ , from the corner. Distance is in units of  $\delta$ , the skin depth.

tip are greater than those of equivalent flat surface, while those at the corner are less. In effect, the eddy currents take a short cut at the corners and a long trip around the tip. The net dissipation, per unit length of crack, for a crack of depth  $d$ , with  $d > 4\delta$  is

$$(2d-0.78\delta) |H_0|^2 / (2\sigma\delta) . \quad (2.5)$$

There is an effective shrinkage of the depth, relative to equivalent flat surface, of approximately 0.396. For cracks more shallow than  $4\delta$ , a direct solution is necessary. This will be done in the following section.

### 3. Surface Crack on a Long Cylinder

In this section, we present the results of calculations of the eddy currents in a long cylinder with a radial crack at the surface. The calculations were performed for arbitrary depth of crack, and the results were developed in terms of an infinite series of trigonometric functions and cylindrical Bessel functions. The results can be made visualizable by means of the impedance diagram.

In figure 5 we show the familiar impedance diagram for a solenoid enclosing a cylinder (with a 100 percent filling factor) [1]. The plot shows the imaginary versus the real parts of the impedance of the coil. A point on the curve corresponds to a particular value of the ratio of cylinder radius to skin depth,  $a/\delta (= a\sqrt{\sigma\omega\mu}/2)$ .

The effects of cracks of varying depth are now shown in figure 6. Our first observation is that the presence of a crack does not change the shape of the curve; it only shifts the position on the curve of each  $a/\delta$  point. For an initial attempt to understand the phenomena, we calculated the impedance curves for cracks of depth  $d = 2a$ ,  $a$ , and  $0.5a$ . We have plotted these curves, shifted in space in the figure. Equal values of  $a/\delta$  on the different curves are connected by dashed lines. It is evident that the greatest shift of impedance caused by the presence of the crack occurs for  $a/\delta \approx 1.7$ , where the curve has a vertical tangent.

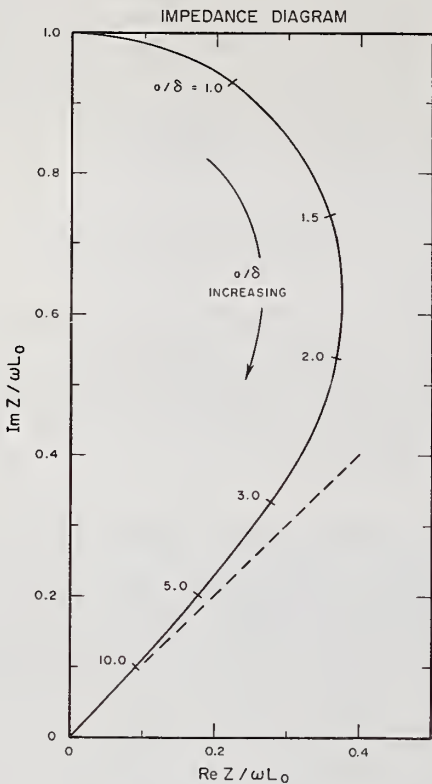

Figure 5. Impedance diagram for a long cylindrical solenoid with a conducting core which completely fills the solenoid. The real and imaginary parts of the impedance are normalized to  $\omega L_0$ , the reactance of the empty solenoids. Points on the plot correspond to particular values of  $a/\delta$ , the ratio of core radius to skin depth.

These calculations have not yet been carried out for very shallow cracks because of slow convergence of the series. To cope with this difficulty, we have developed as an alternative a variational approach which should yield greatest accuracy for shallow cracks and which will overlap the region treated by the series method. This work is now in progress.

A provisional estimate for the effect of the crack can be given. If the frequency is chosen so that  $a/\delta \approx 1.7$  (near the maximum dissipation), then we expect the shift of the  $a/\delta$  to be  $\approx -0.4$  times the value of  $d/a$ . For these values, the impedance change is imaginary and corresponds to a shift of the amount

$$\Delta \left( \frac{\text{Im}Z}{\omega L_0} \right) \approx 0.4 d/a . \quad (3.1)$$

This value will be determined more precisely as the work proceeds.

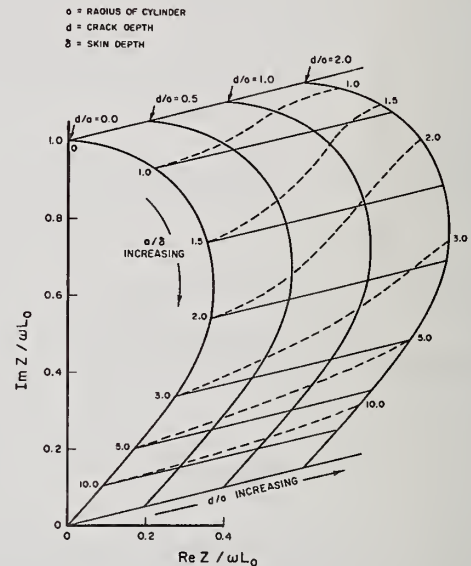

Figure 6. Impedance diagrams for a long cylindrical solenoid with a conducting core which contains a radial surface crack. Impedance curves are plotted, as in figure 5, for three selected depths of crack. The dashed lines schematically indicate the shifts of  $a/\delta$  points as the crack depth,  $d$ , is varied in the calculations.

#### References

- [1] Libby, H. L., Introduction to Electromagnetic Nondestructive Test Methods (Wiley-Interscience, New York, 1971).
- [2] Burrows, M. L., "A Theory of Eddy Current Flaw Detection," Dissertation, University Microfilms, Inc., Ann Arbor, Michigan (1964).
- [3] Dodd, C. V., Deeds, W. E., and Luquire, J. W., Int. J. of Non-destruct. Testing ], 29 (1969).
- [4] Kahn, A. H., Spal, R., and Feldman, A., J. Appl. Phys. (to be published).



[5] Collin, R. E., Field Theory of Guided Waves (McGraw-Hill Book Co., New York, 1960).

#### Discussion

Question (Mr. Libby): I understood you to say that you found no difference in the shape of the curve for these conditions?

Answer (Mr. Kahn): We found slight differences which we believe are computer error.

Comment (Mr. Libby): I am rather surprised at this. What it indicates, looking at the curve, is that the effect of the crack would be the same effect obtained by lowering the frequency.

Answer (Mr. Kahn): Right.

Comment (Mr. Libby): I would expect when the currents are flowing in the usual way about the crack, there would be some component that tells the coil that we are dealing with a bar having a smaller radius. I am just wondering why this is not the case.

Question (Mr. Kahn): You are saying it is not?

Answer (Mr. Libby): I would expect the effect to show up in the size of the curve. I would expect that where you have a curve like the one shown that with a smaller diameter it would shift down and the curve would be in a different place on the complex plane. This is what I would expect.

Comment (Mr. Kahn): I normalized the curve, it is normalized to the inductance of the empty coil.

Question (Dr. Birnbaum): Perhaps I did not understand. You based the calculations on what assumption, that the skin depth was much larger than the crack depth?

Answer (Mr. Kahn): No, it is arbitrary. The whole curve marks out an arbitrary range of the skin depth from zero to infinity.

Comment (Dr. Birnbaum): Well, then I agree with Libby, it defies intuition. One would expect that as you vary the frequency, the skin depth becomes the same order as the crack length, and then when it becomes larger you would get some more drastic differences in impedance.

Comment (Mr. Kahn): No, I find it just moves it on the curve.



DISCUSSION  
NEW SCIENCE DIRECTIONS AND OPPORTUNITIES  
CONCLUDED FROM WORKSHOP SESSIONS

Robert E. Green, Jr.

Johns Hopkins University  
Department of Mechanics and Materials Science  
Baltimore, MD 21218

In the first talk of the Workshop, by Dr. Mc Master, the point was made that much of the eddy current instrumentation and test methods existing today has not advanced beyond principles established in 1830. Eddy current development work has used the new technologies available only to refine and improve systems that have been used for many years. New approaches to basic problems are almost nonexistent. Beyond this, much of the information that is present in an eddy current test is completely ignored.

Listed in figure 1 are general areas in which research and development work could be done. These areas are meant to be independent of standards. They are areas which could be important for scientific as well as technological progress. Your comments on these areas, or additions you might make are important.

- I. Specimens
  - Ferrous
  - Nonferrous
  - Homogeneity
  - Anisotropy
  - Geometry
  - Multilayer
- II. Coils
  - Geometry
  - Orientation
  - Arrays
  - Other Detectors
  - Computer Involvement
- III. Displays
  - Go, No Go, or Meter
  - CRT
  - Other Imaging Devices

IV. Environment

Thermal  
Radiation

V. Other Methods

Microwave  
Triboelectric

Figure 1. General areas for research and development work.

Although I have not listed the various items in any special order, we definitely have to consider the material aspects of the part to be inspected. In a research laboratory, we can tailor make materials so that a given physical property can be varied in a systematic manner while holding other properties constant. Thus, in the laboratory, we can use specially selected materials to test the sensitivity of eddy current instruments to a variety of material parameters. On the other hand, in field eddy current testing, we have to work with materials which have usually been optimally designed to possess desirable mechanical properties, but which may possess extremely complex electrical and magnetic properties and, therefore, present special problems for eddy current testing. Thus, we must consider, as has been pointed out several times, whether the material is ferrous or nonferrous and probably even more critical with respect to eddy current measurements is the inhomogeneity of real structural materials.

In my own opinion, a good eddy current tester is a fairly sensitive scientific device, and therefore it measures both changes in electrical conductivity, magnetic permeability, and geometrical effects. Alloy type materials which are



most commonly used, have more than one chemical or elemental constituent, and these often segregate in different configurations. Therefore, you will not get a constant eddy current reading no matter what parameter you are measuring on your standard piece, if the eddy current detector is sufficiently sensitive. I am not really clear in my mind how this is going to be overcome in general, but I think that specimens are an area for consideration.

Multi-layer types of materials are also important. There was some work reported, and composite materials were briefly mentioned. Here, we are dealing with extreme inhomogeneity of some types of materials to be inspected. If a scientist was concerned with materials, I think this first section would be of great interest to him in not only making conductivity measurements, permeability measurements, etc., but perhaps residual stress type measurements or other types.

The geometrical problem was pointed out by several people. People would like to be able to inspect various configurations and parts of present configurations that cannot presently be done.

Most of the other areas I would think would appeal more to electrical engineers, electronic engineers, or physicists, or people with that bent.

With respect to coils, Professor Mc Master brought up a number of the parameters in his talk the first day. The different geometries of coils, using a coil of triangular or ellipsoidal shape, might be of interest. The orientation of the coil with respect to the work piece and the applied magnetic field could be studied. And perhaps, arrays of coils or arrays of other types of detectors may be useful for rapid scanning. Several people have pointed to the need for that. You could also have other detectors, not just the little coils that we normally use. Some other detectors may lead more naturally into an array configuration than the coils. I know that a lot of work is going on in arrays for ultrasonic testing, and I do not see why we would be prohibited from doing this in eddy current work.

We have heard mentioned the use of computers for signal processing. There is the possibility of using computers to not only analyze the data, but also to control

what kinds of data we measure. And that, again, would tie in with the array; they could be used with fast scan systems. Computer-controlled ultrasonics systems are already making great progress in this regard.

The display could range from a red and green light for some types of operators, to a very complicated type of display if it was for a scientist in a research lab. I would hope it would not bother him too much how complicated the pattern looked.

I can see some interesting work being done on developing imaging type displays to go along with the arrays, or with the rapid scanning, where you could display pictures of defects. I would think whether we like it or not, most people, non-specialists especially, really like to see pictures of a defect or flaw and that is the thing that is coming in this field as well as other fields.

Multi-frequency techniques and the pulse techniques are both options that people are developing and using, and it appears that more work can be done there. I was especially interested in Professor Waidelich's little equation. When you get a good equation from experimenting, one which theoreticians have not derived, it stimulates theoretical work. From the new theoretical work, in turn, you can expand the experimental investigations. So, this is a nice area to look into almost immediately.

Eddy current testing in hostile environments presents special difficulties. Several people brought up the problem of testing hot items. This also could apply to cold items, if you happen to have some work in Alaska. Either extreme of temperature will affect test results. With respect to hostile radiation type environments, there appears to be considerable progress from the talk given yesterday, especially the device that Clyde Denton talked to us about.

Other methods are very interesting to me, such as the microwave technique and the phenomenon that Professor Mc Master pointed out, triboelectricity, materials emitting electromagnetic waves spontaneously, similar to acoustic emission.

I would like to have some discussion now, and in the discussion, consider your

own practical needs. Where could some scientific work be done that would be useful to you?

Mr. Brown: At the risk of sounding too simple, I would suggest that a significant contribution could be made if you figured out how to make a reproducible hole in the side of a tube. There are many types of standards, paper standards that call for a hole of one form or another, 20 percent or 50 percent through the wall or all the way through. But I am not convinced, in fact, I am very insecure about the reproducibility of some of these holes from one piece to another. The boiler code calls for a flat bottom hole to go part-way through, and some of the other standards call for holes all the way through. But many people use holes for various purposes, and I do not think those holes are reproducible enough. I suspect that NBS could do something that would help people manufacture reproducible holes so the data was more comparable back and forth across the country.

Dr. Green: I assume you mean by a hole, not only the hole itself, but what would happen to the material surrounding the hole when the hole is made?

Mr. Brown: Right. This would include deburrings on the inside of a tube, which could be a real problem.

Dr. Green: Perhaps even the residual stress?

Mr. Weismantel: Wouldn't you want to start by putting holes in flat plates first? Eventually, you have to get to a radius effect, but you have to start with something basic and then build up the mechanism to get into the more involved three-dimensional structures at different radii.

Mr. Wehrmeister: I was just going to suggest SDN-243 which is for copper inspection, primarily copper tubing inspections. It offers some guidance to drilling holes and filing notches in material, and also some tolerances which people in that particular industry have been living with for a good number of years.

Mr. Berger: I do not want to turn off this discussion, but I would like to ask a question. Is there a need for greater theoretical work to go along with putting holes into flat plates or tubes or

whatever to better understand just what is happening as far as the electromagnetic fields are concerned?

Dr. Mc Master: Could I respond with a suggestion for your organization? I feel one of the problems is that if you take all of these problems in one "mishmash," you are going to have to have a Latin squares statistical experiment to figure out what did what. If we divide it in sequence in terms of fundamental phenomena, we can have many different groups working on various aspects. So, let me suggest this division of the problem, and it is only a suggestion.

The first area of study would be the magnetizing coils and their fields and anything that has to do with magnetizing coils and their fields, including how these fields are modified when they are in the presence of a test object. This is a field which could be handled by a group of people. It involves a portion of these problems, and involves fundamental theory and related analyses.

A second field of study would be the eddy currents. It is perfectly possible in an eddy current instrument to wipe out the entire coil signal with electronics, and then measure nothing but eddy currents. It seems to me, we should study the eddy currents. It is easy to do in the constant current instruments, if you abolish the coil field and forget it from now on and go to the eddy currents and their distribution in the metal, for all the different shapes and/or frequencies that affect distribution and/or defects, etc. That could be done possibly by techniques like we saw demonstrated earlier.

A third level is the magnetic field created by the eddy currents. This is a different problem from the eddy current distribution. The eddy current magnetic field is superimposed in space and with nonferromagnetic test objects we have seen that superposition applies. Thus, we can analyze it independently of the magnetizing coil field.

And, finally, the detector response to the induced field. Since the detector responds in a uniform way to its magnetizing coil field in the absence of a test object, the induced field response can be considered independently. Obviously signal analysis and interpretation would be another area of endeavor.



Now, the only reason I suggest this classification is the obvious fact that you can divide the job into four parts or five and each could be thoroughly explored independently of the others. And maybe when you put the pieces together you have a coherent program.

Mr. Libby: One comment. I would join the first two areas since current distributions are very definitely a function of the coil geometry.

Dr. Mc Master: Yes, there is no question about that. But if you subdivide and conquer the pieces, you may be able to analyze the relationship between these pieces. If you put them all together, the problem gets too complex, at least for my mind.

Mr. Weismantel: I think the way Dr. Mc Master has organized the problem is a very logical way to go. But, I would like to see coming out of this whole thing some computer modeling which would give us a much more valuable tool, more powerful tool for the application of the process. The problem I face is characteristic of many people. A lot of applications of eddy currents that are successfully used are volume testing of parts with a similar geometry.

For example, in a turbine engine you might have 30 different shapes that are unique to whatever the component is that has to be inspected. These vary in alloy, and they vary in electrical and thermal conductivity characteristics. We must have a way of building up the theory so that we do not have to do everything by empirical means. We have to know how to handle a radius, and determine what the sensitivity is for finding a flaw in that radius relative to the sensitivity on a flat plate. This requires a further extension of Maxwell's equation and a development of a scientific approach to the subject.

Mr. Titland: In the area of displays, you mentioned two things, either a red and green light, or a picture. But I think there is a third item that should be considered in displays, that is the standard with holes and defects which checks the sensitivity of the instrument. For example, the inspector who comes along when you are testing pressure vessels likes to see that the standard will truly check the functioning of the instrument. The reason I mention this is there has

been some talk about electrically calibrating detectors. I think that is okay and should be done, but let's not forget about the actual standard.

Dr. Green: Any other suggestions?

Mr. Brown: This is a negative suggestion. I agree with all these lofty ideals and have for years, like everybody else. But I caution NBS not to take on the world. Do not try to do it all. We have all found that it is not practical. Do a good job in the standards field first; do not try to expand into everything.

Mr. Mester: In response to some of Bob Mc Master's suggestions, the idea occurred to me, and other people have mentioned it in some of the previous discussions, of using taped data. In my company, we are working to correlate responses from our equipment to information gathered about actual defects in the material which are determined by other methods.

What we do is set our instrument condition to take the run data and running the instrument at a particular setting, for instance. This is a one-shot test since the material is hot, you never get a chance to run it again. It can never be run through under the same conditions, but the data is now on tape. You go back and actually put the tape data back in again, changing time constants and levels, reject levels, to force the conditions to fit what the correlations should be.

What I think may be appropriate when considering how my equipment compares with the other fellow's equipment, is producing on magnetic tape, for instance, a signal which is indicative of, or representative of, some standard defect. Of course, the information on the tape is determined by environmental conditions, the size of the coil, the field, and many other things.

But I am saying you have established at least some reference. This tape can be given to people who would feed it in at some point in their equipment for testing. Maybe their signal has a lot of noise and they are trying to determine just how capable the equipment is of handling that background noise. This may be helpful when everybody is working with the same type of signal. They have the signal input. What their output is, is determined by a black box. I do not think



you can regulate and say everybody should have the same black box. But if we started with the same hole and the same applied field and we have the same eddy current pattern, we are looking at the same output. The rest of your system I think you have to consider separately, and this may be one way of doing it.



NEW DIRECTIONS FOR STANDARDS CONCLUDED  
FROM WORKSHOP SESSIONS

Norman B. Belecki

Electrical Measurements and Standards Division  
National Bureau of Standards  
Washington, DC 20234

In any industry, the standards that are used for quality control and for other purposes may have many forms. If the standards that are used do not attack the primary measurement problems of a specific industry, the result is wasted time, money, and unresolved measurement problems. If the standards that are used do not directly relate to the measurement problems that are faced, there is no reason for their existence. From the preceding talks and discussions of the workshop, I have made a list (fig. 1) of areas in which standards or calibration services might have a direct impact on industry.

- (1) Conductivity Standards
  - Calibration Service
  - Standard Reference Materials
- (2) Terminology
- (3) Performance Standards
  - e.g., Probe Characteristics
- (4) Reference Data
  - (a) Metals
  - (b) Comparison of Methods
  - (c) Geometrical Effects
- (5) Tutorial Material, to bridge gap between theory and practice.
- (6) Measurement Methods,
- (7) Standards and Recommended Practice for Cladding Measurement.
- (8) Ferromagnetic Standards
- (9) Sensitivity Tests for Equipment
- (10) Round Robin Tests with Standard Defects.

Figure 1. Area for standards development.

Before starting the discussion on standards for eddy current testing, I would like to raise several questions about our own present program, i.e., conductivity standards. Is an electrical conductivity service, either a calibration of customers' conductivity samples or the issuance of

electrical conductivity SRM's important to the eddy current work now being done in industry? If this type of standard and calibration service is important, what are the limits, in percent IACS, that should be offered? At present, we are thinking of working in the area of 3 percent to 100 percent IACS. But should we go lower than 3 percent and if so, how low should we go? A final question related to the conductivity standards is the range of frequencies that are important in the testing of samples. Much of the commercial eddy current equipment functions at 60 kHz. Should we limit ourselves to testing at this frequency? In the testing of other electrical parameters, I have found that when one of the parameters is limited in range, there is a tendency to restrict advances which could be made in areas that are peripheral to this parameter.

These are a few of the questions related to eddy current standards that I think need answers. Now, we would like to open the floor to discussion and questions you might have about eddy current standards, what standards are needed now, and what standards will be needed in the future.

Discussion

Mr. Weistmantel: Why limit the conductivity standards to 3 percent IACS? Why not go lower?

Mr. Belecki: That is what I am trying to get at; how low should we go? That is the question I am raising.

Mr. Weismantel: Go down to as low a conductivity as we have commercially available materials. I do not know how low that would be.



Mr. Free: I had a conversation with someone from the steel industry several weeks ago, and I do not know whether this information is accurate or not. He stated that for many types of your lower conductivity materials, one percent or below, eddy currents really do not give you much useful information. You do not search with them; you cannot tell the difference between heat treats. It does not give you the needed information.

Dr. McMaster: I do not agree. I would hate to take a piece of steel and try to analyze its contents, including residual things like gases with eddy currents. But, when you get down to titanium or something like that, you have a chance. I would suggest we have missed a very valuable area down there, far more than we know. Although these are exotic, costly five dollars-a-pound materials used in critical applications, where do you have a greater need? I would encourage going all the way. I would like to see you go down to 100th of 1 percent with conductivity standards.

Mr. Brown: You can sort graphite that way and it is 1000 micro ohm centimeters.

Dr. McMaster: And finally, when you come to graphite fibers in a matrix, you are going to establish orientation, packing density, etc., by eddy currents. By taking directional magnetic fields, you can get a pretty good idea of the angle of orientation.

I think there will be a great deal of engineering moving out of straight metals into composites and refractory materials, which by the way become conductive when they get hot enough. Glass is a beautiful conductor at higher temperatures.

Mr. Belecki: I was wondering if there were any other geometries that would be desirable in conductivity standards. If so, what would they be?

Mr. Wehrmeister: I am just guessing, but I would think foil, a very thin material, would be of interest as a conductivity standard. And that, of course, is going to have a very large effect on the range of frequencies that you are talking about.

Dr. McMaster: On the other hand, the upper range of frequencies should be in the microwave range and beyond. In the future, we will be interrogating refractory

coatings on metals by impedance mismatch reflection signals and their phase or amplitude. Where it is possible to go up through that range of frequencies it would be very helpful.

Mr. Blew: What kind of correlation would your samples have with what NBS is doing with wafer resistivity samples?

Mr. Belecki: I think we would have to run experiments to be sure that our measurements are consistent throughout their range.

Mr. Free: This brings up a point. I do not know whether it should be discussed here or not. I wanted to raise it this morning, but we did not have time. The idea of the percent IACS scale for conductivity--is it meaningful when the only time we use it is when we do a calibration?

Anytime we are doing a real honest-to-goodness measurement, we are talking about ohms, units of length, etc; we are never talking about percent IACS except as a mythological beast.

Dr. McMaster: It is used in the copper industry for electrical copper only.

Mr. Jones: The aircraft industry uses it for sorting incoming material.

Dr. McMaster: Only because the meters have an IACS scale.

Mr. Jones: It is a workable system. We did not like it either when we started making the standards, but it does work.

Mr. Endler: There are many commercial and military specifications about IACS.

Mr. Belecki: I think that any change of units would probably have to be done gradually as these specifications came up for review, to use both, and then eventually remove the IACS. That is the normal way of doing things.

Mr. Blew: On the sample geometry--are you going to define criteria there, or is it going to be up to this group to set the standard geometry, thickness, and so on?

Mr. Belecki: One of the things that we hope to do when we get around to con-

sidering the SRM's and what form they should have, would be to get together with all the instrument manufacturers and discuss the standardization possibilities in that area. I think it is almost crucial in order to get the optimum performance out of these standards, and I think that the spill-out of that kind of a meeting would have an effect, too, on what we would say for criteria on samples submitted to NBS for calibration.

There is an analogy to our regular calibration program for standards. It is clearly written in the SP-250, which is the publication that describes our services, that we will not accept instruments for calibration or standards for calibration if they are not serviceable. The same kind of general statement can serve for conductivity samples.

I think that as time goes by all that kind of thing will be ironed out as well. This problem is analogous to that of standard resistors. Standard resistors generally, especially those designed for oil immersion, have mercury contacts and certain dimensional characteristics and our equipment is designed to accommodate all of those kinds of variables. I assume that that kind of accommodation will be reached.

Mr. Blew: Do you have an idea of the fee, as compared to your standard resistors?

Mr. Belecki: No. The only thing I would say is that there is a good likelihood that all the measurement equipment is going to be automated.

Congress requires us to recover the cost of carrying out the operation; not necessarily of establishing the capability, but carrying out the operation.

Mr. Blew: What would be an approximate price? What is a standard resistor calibration costing now?

Mr. Belecki: It could be anything from \$100 to \$200, someplace in that range, depending on the work involved. But I do not think this would cost anything like that.

Dr. McMaster: I get a vague impression that you are expecting to use as standards commercially available metals and alloys, materials that suit your needs. At first glance, that seems like

the hard way to go about it. Wouldn't it be far simpler to start with a relatively pure material like aluminum, and progressively alloy in copper to cover that range from 100 percent down to 60 percent down to 38 percent or so, and do this in a controlled experiment so you can build them to demand? And in fact, if you had a method of hot measurement of the conductivity, you might even tell when you are there, very much like you do in steel.

Mr. Belecki: Yes, we have talked about a number of such things.

Dr. McMaster: You could add phosphorus to copper to get the rest of the scale. And then finally, a third suggestion would be for those things that are somewhat different conductivity per unit square imitating thin foils. The tin oxide coating, a nonelectrostatic coating, they are Nisa coatings made by Pittsburgh Plate Glass, can be laid down on glass. You can put it on glass, quartz, or ceramic so you can have a stable base, you spray on tin fluoride, methanol and so on solutions at maybe 1100°F, 1200°F or higher temperatures, and it comes out with a glossy, chemically resistant, extremely adherent, and, as far as I know, longtime stable coating. This is what is used on the windshields of jet aircraft.

Mr. Belecki: You spoke of these things Wednesday night.

Dr. McMaster: Yes. I would like to suggest that artificial standards are far more easily prepared than finding a lot of aluminum that is consistent in its conductivity, because they do not make aluminum specifically for its electrical conductivity except for certain conductors. If you make your own you could adjust it and possibly have a feedback control device so that when you approach the desired conductivity, you slow it down or stop. You could make many of them more precisely, and you could cover everything in uniform steps instead of having these funny steps that we have now.

Mr. Free: This was another area I wanted to bring up this morning and did not. Is it better to make ideal conductivity standards, more of what you are talking about or, is it better to come out with standards which are really the most common alloys?

Dr. McMaster: The point is these are used to calibrate instruments. If you are



calibrating an instrument, you would like to know in what range or percentage of full scale, it is accurate. The standards are never actually used in a comparison coil to detect a matching alloy. It is an instrument calibration standard.

Mr. Free: Where I would see the handiness of one of the aluminum alloys, is that it can be carried right to the industrial setup, and you do not have to worry about corrections for temperature. You are zeroing in on that alloy, so to speak, and you are comparing it with a lot of the same alloy you know is in your warehouse.

Dr. McMaster: Those are secondary standards.

Mr. Belecki: The other advantage in the alloys is if a person has a lot of measurements on exactly the same metal sample, that will allow him to apply differential measurement techniques, rather than trying to make an absolute conductivity measurement, and raise the sensitivity several orders of magnitude because of that.

Mr. Richardson: Are you going to tell us how to make the measurements on a conductivity standard?

Mr. Belecki: I think that would probably be useful. The area of reference data is another area that we do not have any immediate plans in, but it is something that might be useful for various people.

Mr. Brown: Those of us who have looked in 10 to 100 books for the values of resistivity, would like to have one list with all the materials on that list.

Mr. Schwarz: How about some reference data on permeabilities of various steels?

Mr. Weismantel: Reference data does not have to be limited to eddy currents you know. Velocity of sound is an important area.

Mr. Wehrmeister: It was mentioned yesterday that vendors have to run ROI's, returns on investments, to see if it is feasible to do something for general industry. I do not, somehow, suspect that the Bureau runs return-on-investment studies and it might be possible to supply things to industry that could not be normally supplied by an industrial vendor.

Mr. Belecki: I think that is true.

Mr. Wehrmeister: Especially in custom-made standards, for example.

Mr. Belecki: I think that is surely true. We have done that in a couple of cases. In my own field, for example, an electronics company was having problems verifying measurements on the production line for ladders used in A/D converters, and we built a special transportable standard so that we could directly test that process with them.

That brings up another thing that your talk implied; we have methods of servicing customers in our regular calibration areas via techniques similar to the round robin method that you talked about. It might be a very useful approach especially in relation to those areas where people have a lot of data, but do not know how to correlate it with data that somebody else has.

Mr. Reinhardt: There is another role for NBS. I am always looking for unconcerned third parties; a team that might have some interest, personal or professional, in looking at a test a certain way.

Mr. Belecki: Considering measurement methods, one of the things I thought of that would be useful would be a method of testing the sensitivity of measuring equipment. That seems to be somewhat in question in some of these various areas. The work at Battelle Northwest that was described yesterday by Mr. Davis would be a possible way to pursue that type of test.

Mr. Brown: Along the lines of a measurement method, there is a significant degree of uncertainty in describing the many variables in an eddy current test; how it is set up, how stable it is, what the results are and what do they mean etc.; probabilities and statistics are involved. I recognize there are practical and statistical methods for handling these things; but, from the users' standpoint they usually are too complicated for practical application.

Mr. Belecki: We have the same problems in the standards area.

Mr. Brown: The Bureau of Standards could make a great contribution by evolving some simple--let me say that



three times--simple, simple, simple--statistical techniques, for evaluating the uncertainties involved.

Mr. Belecki: I suspect that there are large numbers of measurements made on clad surfaces, and I wondered what kind of standards might be useful in that area?

Mr. Jones: Mil 1537 covers a little bit of that. I have been rewriting it. We are also putting definitions in, which comes under terminology. Maybe NBS, would be interested in seeing what we define as conductivity in primary standards, secondary standards, etc., so we could get some agreement at the beginning, because it is still being written.

Mr. Weismantel: Do you really want to get into the areas you have listed there? In other words, standards for cladding, standards for defects? You have tubings, you have other things. It seems to me that there are so many ungodly combinations of things, alternatives.

Mr. Belecki: I think that the way I would have to answer that would be to say that we would get into an area if it were useful to get into, and were within the range of our resources to do so. I understand what you are saying. We could not possibly supply people with artifacts or calibration service for standard flaws for every possible conceivable application.

Mr. Weismantel: A problem that we have is the fact that there are not any good standards available that can be used to measure relative detection efficiency to determine when there are improvements or lack of improvements in a process due to advancements in the process technology. There is no base to say that one instrument or method is better than another. The T-crack blocks that I discussed in my talk is our attempt to do this internally. They are our own controls to get a measure of where we are. But it would be extremely useful if somewhere there was a grand master series of buried defects. No EDM notches or anything like that, but subsurface flaws, that could be used to gauge process efficiency. There are techniques in which you can produce subsurface flaws of different sizes in character and orientation. And natural-looking flaws, not EDM notches and things of this sort.

Mr. Belecki: Well, don't you think there is some possibility of being able to synthesize those kinds of things artificially?

Mr. Weismantel: That is what I am saying, you can artificially synthesize them.

Mr. Ammirato: That depends on what object you are after. On the one hand, you have to calibrate the instrument to make sure that is working all right. On the other hand, you are trying to get some idea of what the actual flaw size is in your part. If you have them varied, you will not know what size they are.

Mr. Weismantel: You can develop a technique where you get a good prediction of what the size is. We have gone through it, but not being farsighted enough, we cut these things up, something which you would like to avoid so that the test pieces are preserved. Then you can always go back and measure relative detection efficiency. The defects have to be in large enough quantity to give you some statistical appraisal of what you have got.

Mr. Titland: Two comments on this: First, I think the Welding Institute in England has developed a technique where a flaw is placed inside the material by machining in pieces, and then putting the pieces together in a vacuum. I think this technique may be available. Secondly, when we make a standard it could be used not only for eddy current, but also for radiographic and ultrasonics.

Mr. Belecki: That is right.

Mr. Weismantel: So that you could compare the efficiency of the different processes.

Mr. Reinhardt: This, to me, is a very critical area, this simulation of real defects and keeping them in an archival place. It opens up another area which is a computer learning method. If you have them in some central place where they are never taken apart, this allows people with the difficulty to go there. We have a deficiency of seeing real or simulated flaws in our industry, because the metallurgists get there first and take them apart.

Mr. Weismantel: That is the only way they know what size they are.

Mr. Belecki: We only have a couple of more minutes. Synthetic standards like those Tom Davis talked about yesterday could be used in a large variety of ways,

both as ways of testing instrumentation and ways of augmenting some of the theoretical things that we talked about earlier.

One of the things that we were talking about at lunch time, which we thought might be useful, is the characterization of a measurement system component. Perhaps it might be worthwhile to have some sort of performance specifications or something of that order for probes and pickups.

Mr. Weismantel: The ferrites that go into them, start with them because they have a large variability.

Dr. McMaster: And the ceramic bases for the coil forms tend to distort. There should be a ceramic with zero temperature coefficient of expansion, wound with Invar or something, which has a small temperature coefficient.

Mr. Belecki: Any other comments?

Mr. Blew: Not on methods, but on the instrumentation itself as far as the performance is concerned. It seems from what I have gotten, that it is varied as far as the sensitivity and the noise characteristics are concerned. You have been more or less talking about electronics in a black box. I looked at NBS Technical Note 865 from the meeting in 1974 and saw sources and standards, and also on the devices such as A/D D/A, and I imagine stability of analog dividers and so on. I was wondering, has any of this been resolved since the 1974 meeting?

Mr. Belecki: Many of the things that are mentioned in there are being worked on in the program of the Electrical Instruments Section that Barry Taylor discussed yesterday. They have done a fair amount in the way of terminology and data conversion work or at least they are right in the middle of doing that. There are, I think, three committees, IEEE committees and ANSI committees, that members of the section are working on. And I think that especially in the data conversion area, and in the area of microprocessor and instrumentation interfaces, there is work being done.

The noise problem has not been addressed yet, and that brings up another problem that we have heard about from the general instrumentation and test equipment industry. I wonder what comments I might get from you about the effects of noise

coming down the power line on your measuring apparatus. Do you have a lot of problems in that regard? We have had a fair amount of input from companies, especially those making medical instruments, that want some kind of standardization in that area for liability purposes. Right now if they make an instrument that is totally free from that kind of effect, they cannot be competitive.

Mr. Mester: I was just going to say that that is a very big problem. When you buy equipment in the lab it works fine. You put it in the field and you have problems; transducers probably aren't chilled; ground loops exist, you have problems with noise coming in on the line, even if you have taken pains to separate your lines. It is a very big problem, and I do not want to go into it a lot. But it is an area which has been neglected.

## ACKNOWLEDGMENTS

NBS would like to give special thanks to Mr. J. R. Barton of Southwest Research who presented a paper on eddy current testing in the transportation industry. This paper was not available at the time of publication. Also appreciated were presentations by Mr. Rudy G. Hentschel, Hentschel Engineering, entitled "Lets Not Forget Standards for Ferrous Metals," and a review of the work done at Battelle Northwest on Simulating Tubing Flaws by Mr. Tom Davis of Battelle. The former was not available at the time of publication and a complete discussion of the latter topic can be found in Materials Evaluation, "Calibration of Eddy Current Systems with Simulated Signals," by J. C. Crowe, Sept. 1977, Vol. 35, Number 9, p. 59.

We would like to thank ASTM for permission to print the tables which appear at the end of Dr. McMaster's paper. These tables are from ASTM Special Technical Publication No. 112.

Our sincere thanks to all who participated in the workshop.





LIST OF PARTICIPANTS

Frank Ammirato  
General Electric Co.  
M&T Lab, Bldg. 28, Rm. 450  
1 River Road  
Schenectady, NY 12345

J. R. Barton  
Southwest Research Institute  
P. O. Drawer 28510  
San Antonio, TX 78284

Winthrop A. Baylies  
ADE Corporation  
127 Coolidge Hill Road  
Watertown, MA 02172

Robert Betz  
Pratt & Whitney Aircraft  
Department 983  
K Building  
East Hartford, CT 06108

Austin R. Blew  
Lehightron Electronics, Inc.  
R. D. 1, Box 374  
Lehightron, PA 18235

Creighton Booth  
Bethlehem Steel Corp.  
Bethlehem, PA 18016

Russell L. Brown  
Westinghouse Hanford Co.  
P. O. Box 1970  
Mail Stop W-A132  
3707 C Building  
Richland, WA 99352

Don Bugden  
Magnetic Analysis Corp.  
535 S. Fourth Avenue  
Mount Vernon, NY 10550

Carl E. Burley  
Reynolds Metals Company  
4th & Canal Streets  
Richmond, VA 23261

Caius V. Dodd  
Oak Ridge National Laboratory  
Metals & Ceramics Div.  
P. O. Box X  
Oak Ridge, TN 37830

Tom Davis  
Battelle Northwest  
PS Bldg. 3000 Area  
Richland, WA 99352

Clyde Denton  
ZETEC, Inc.  
P. O. Box 140  
Issaquah, WA 98027

Thomas F. Drumwright  
Alcoa Technical Center  
Alcoa Center, PA 15069

John F. Endler  
Quality Assurance  
The Anaconda Company, Brass Div.  
P. O. Box 830  
Waterbury, CT 06720

Robert H. Foxall  
Wean United, Inc.  
P. O. Box 751  
1985 N. River Road  
Warren, OH 44482

John Gleim  
Naval Ship Engineering Center  
Code 610D  
Hyattsville, MD 20782

Robert Green  
Johns Hopkins University  
Mech. & Matls. Science Dept.  
Baltimore, MD 21218

Rudy G. Hentschel  
Hentschel Instruments, Inc.  
2505 South Industrial Highway  
Ann Arbor, MI 48104

Howard Houserman  
Westinghouse NDS  
RSD Center Bldg. 701  
P. O. Box 2728  
Pittsburgh, PA 15230

Art Jones  
Boeing Aerospace Company  
Org. 2-4807, MS 2P-10  
P. O. Box 3999  
Seattle, WA 98124

Tyler W. Judd  
Republic Steel Corporation  
Research Center  
6801 Breckville Road  
P. O. Box 7806  
Independence, OH 44131

John Kollar  
Balteau Electric Corp.  
63 Jefferson Street  
Stamford, CT 06902

Lawrence Lagin  
Grumman Aerospace Corp.  
Quality Control Laboratory  
Plant 10  
Bethpage, NY 11714

A. L. Lavery  
DOT Transportation Systems Center  
Kendall Square  
Cambridge, MA 02142

Hugo Libby  
2302 Frankfort Street  
Richland, WA 99352

Tracy McFarlan  
Magnaflux Corp.  
7300 West Lawrence Avenue  
Chicago, IL 60656

Patrick C. McEleney  
U. S. Army Materials & Mechanics  
Research Center  
Arsenal Street  
Watertown, MA 02172

Robert C. McMaster  
6453 Dublin Road  
Delaware, OH 43015

Michael Mester  
U. S. Steel Corp.  
Research Laboratories  
125 Jamison Lane  
Monroeville, PA 15149

Richard B. Moyer  
AISI Committee on Nondestructive Testing  
and Inspection Materials  
Carpenter Technology Corp.  
Research and Development Center  
Reading, PA 19603

Noel Poduje  
ADE Corporation  
127 Coolidge Hill Road  
Watertown, MA 02172

Eugene R. Reinhardt  
Electric Power Research Institute  
3412 Hillview Avenue  
P. O. Box 10412  
Palo Alto, CA 94303

Guy D. Richardson  
Detek, Inc.  
6807 Coolridge Drive  
Camp Springs, MD 20031

Walter Rolfe  
Magnaflux Corp.  
7300 West Lawrence Avenue  
Chicago, IL 60656

Allen Sather  
Materials Science Division  
Argonne National Laboratory  
Argonne, IL 60439

Ronald Schwarz  
Manufacturing Development Bldg. B  
GMTC  
Warren, MI 48090

L. Erik Titland  
Baltimore Gas & Electric Co.  
Westport Metallurgical Laboratory  
P. O. Box 1475  
Baltimore, MD 21203

Donald Waidelich  
University of Missouri  
Dept. of Electrical Engineering  
Columbia, MO 65201

A. E. Wehrmeister  
Babcock & Wilcox Co.  
Lynchburg Research Center  
P. O. Box 1260  
Lynchburg, VA 24505

E. E. Weismantel  
Quality Measurements  
Mail Drop E45  
General Electric Co.  
Aircraft Engine Group  
Cincinnati, OH 45215

#### National Bureau of Standards Attendees

Dr. L. H. Bennett  
Mr. H. Berger  
Dr. G. Birnbaum  
Mr. N. Belecki  
Mr. G. Free  
Dr. A. Kahn



U.S. DEPT. OF COMM. <b>BIBLIOGRAPHIC DATA SHEET</b> (See instructions)		1. PUBLICATION OR REPORT NO. NBS SP 589	2. Performing Organ. Report No.	3. Publication Date January 1981
4. TITLE AND SUBTITLE Proceedings of the Workshop on Eddy Current Nondestructive Testing held November 3-4, 1977 at the National Bureau of Standards, Gaithersburg, MD.				
5. AUTHOR(S) George M. Free, Editor				
6. PERFORMING ORGANIZATION (If joint or other than NBS, see instructions) <b>NATIONAL BUREAU OF STANDARDS DEPARTMENT OF COMMERCE WASHINGTON, D.C. 20234</b>			7. Contract/Grant No.	8. Type of Report & Period Covered Final
9. SPONSORING ORGANIZATION NAME AND COMPLETE ADDRESS (Street, City, State, ZIP) Same as No. 6				
10. SUPPLEMENTARY NOTES Library of Congress Catalog Card Number: 80-600172 <input type="checkbox"/> Document describes a computer program; SF-185, FIPS Software Summary, is attached.				
11. ABSTRACT (A 200-word or less factual summary of most significant information. If document includes a significant bibliography or literature survey, mention it here)  The proceedings of the Eddy Current Nondestructive Testing Workshop held at NBS in November, 1977 contains papers related to all areas of eddy current testing. A historical overview of the discipline from its inception until the present is given. Other papers discuss the use of eddy current testing in the primary metals industry (both ferrous and nonferrous metals), the use of eddy currents for the sorting of metals and for defect detection, the state-of-the-art in eddy current instrumentation, and the use of signal processing in the analysis of eddy current signals. The development and use of eddy current standards is discussed as well as several of the newer areas of eddy current development, i.e., multifrequency and pulsed eddy current techniques.				
12. KEY WORDS (Six to twelve entries; alphabetical order; capitalize only proper names; and separate key words by semicolons) Conductivity; defect detection; eddy current test; multifrequency; nondestructive testing.				
13. AVAILABILITY <input checked="" type="checkbox"/> Unlimited <input type="checkbox"/> For Official Distribution. Do Not Release to NTIS <input checked="" type="checkbox"/> Order From Superintendent of Documents, U.S. Government Printing Office, Washington, D.C. 20402. <input type="checkbox"/> Order From National Technical Information Service (NTIS), Springfield, VA. 22161			14. NO. OF PRINTED PAGES 153	
			15. Price \$5.50	



# NBS TECHNICAL PUBLICATIONS

## PERIODICALS

**JOURNAL OF RESEARCH**—The Journal of Research of the National Bureau of Standards reports NBS research and development in those disciplines of the physical and engineering sciences in which the Bureau is active. These include physics, chemistry, engineering, mathematics, and computer sciences. Papers cover a broad range of subjects, with major emphasis on measurement methodology and the basic technology underlying standardization. Also included from time to time are survey articles on topics closely related to the Bureau's technical and scientific programs. As a special service to subscribers each issue contains complete citations to all recent Bureau publications in both NBS and non-NBS media. Issued six times a year. Annual subscription: domestic \$13; foreign \$16.25. Single copy, \$3 domestic; \$3.75 foreign.

NOTE: The Journal was formerly published in two sections: Section A "Physics and Chemistry" and Section B "Mathematical Sciences."

**DIMENSIONS/NBS**—This monthly magazine is published to inform scientists, engineers, business and industry leaders, teachers, students, and consumers of the latest advances in science and technology, with primary emphasis on work at NBS. The magazine highlights and reviews such issues as energy research, fire protection, building technology, metric conversion, pollution abatement, health and safety, and consumer product performance. In addition, it reports the results of Bureau programs in measurement standards and techniques, properties of matter and materials, engineering standards and services, instrumentation, and automatic data processing. Annual subscription: domestic \$11; foreign \$13.75.

## NONPERIODICALS

**Monographs**—Major contributions to the technical literature on various subjects related to the Bureau's scientific and technical activities.

**Handbooks**—Recommended codes of engineering and industrial practice (including safety codes) developed in cooperation with interested industries, professional organizations, and regulatory bodies.

**Special Publications**—Include proceedings of conferences sponsored by NBS, NBS annual reports, and other special publications appropriate to this grouping such as wall charts, pocket cards, and bibliographies.

**Applied Mathematics Series**—Mathematical tables, manuals, and studies of special interest to physicists, engineers, chemists, biologists, mathematicians, computer programmers, and others engaged in scientific and technical work.

**National Standard Reference Data Series**—Provides quantitative data on the physical and chemical properties of materials, compiled from the world's literature and critically evaluated. Developed under a worldwide program coordinated by NBS under the authority of the National Standard Data Act (Public Law 90-396).

NOTE: The principal publication outlet for the foregoing data is the Journal of Physical and Chemical Reference Data (JPCRD) published quarterly for NBS by the American Chemical Society (ACS) and the American Institute of Physics (AIP). Subscriptions, reprints, and supplements available from ACS, 1155 Sixteenth St., NW, Washington, DC 20056.

**Building Science Series**—Disseminates technical information developed at the Bureau on building materials, components, systems, and whole structures. The series presents research results, test methods, and performance criteria related to the structural and environmental functions and the durability and safety characteristics of building elements and systems.

**Technical Notes**—Studies or reports which are complete in themselves but restrictive in their treatment of a subject. Analogous to monographs but not so comprehensive in scope or definitive in treatment of the subject area. Often serve as a vehicle for final reports of work performed at NBS under the sponsorship of other government agencies.

**Voluntary Product Standards**—Developed under procedures published by the Department of Commerce in Part 10, Title 15, of the Code of Federal Regulations. The standards establish nationally recognized requirements for products, and provide all concerned interests with a basis for common understanding of the characteristics of the products. NBS administers this program as a supplement to the activities of the private sector standardizing organizations.

**Consumer Information Series**—Practical information, based on NBS research and experience, covering areas of interest to the consumer. Easily understandable language and illustrations provide useful background knowledge for shopping in today's technological marketplace.

*Order the above NBS publications from: Superintendent of Documents, Government Printing Office, Washington, DC 20402.*

*Order the following NBS publications—FIPS and NBSIR's—from the National Technical Information Services, Springfield, VA 22161.*

**Federal Information Processing Standards Publications (FIPS PUB)**—Publications in this series collectively constitute the Federal Information Processing Standards Register. The Register serves as the official source of information in the Federal Government regarding standards issued by NBS pursuant to the Federal Property and Administrative Services Act of 1949 as amended, Public Law 89-306 (79 Stat. 1127), and as implemented by Executive Order 11717 (38 FR 12315, dated May 11, 1973) and Part 6 of Title 15 CFR (Code of Federal Regulations).

**NBS Interagency Reports (NBSIR)**—A special series of interim or final reports on work performed by NBS for outside sponsors (both government and non-government). In general, initial distribution is handled by the sponsor; public distribution is by the National Technical Information Services, Springfield, VA 22161, in paper copy or microfiche form.



**U.S. DEPARTMENT OF COMMERCE**  
**National Bureau of Standards**

Washington, D.C. 20234

OFFICIAL BUSINESS

Penalty for Private Use, \$300

POSTAGE AND FEES PAID  
U.S. DEPARTMENT OF COMMERCE  
COM-215



SPECIAL FOURTH-CLASS RATE  
BOOK

---